

Schottky Diode

$$V_{RRM} = 200\text{ V}$$

$$I_{FAV} = 2 \times 15\text{ A}$$

$$V_F = 0.78\text{ V}$$

High Performance Schottky Diode
 Low Loss and Soft Recovery
 Common Cathode

Part number

DSA30C200IB

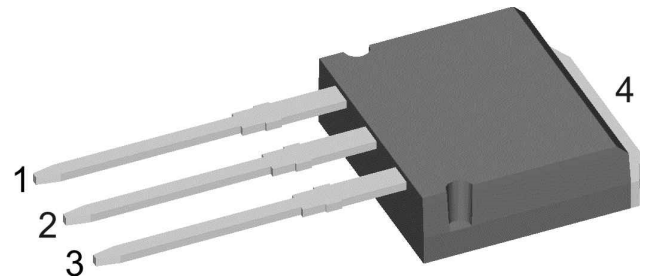

Backside: cathode

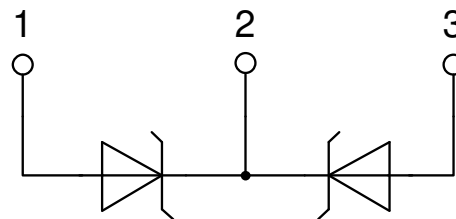

Features / Advantages:

- Very low V_f
- Extremely low switching losses
- Low I_{rm} values
- Improved thermal behaviour
- High reliability circuit operation
- Low voltage peaks for reduced protection circuits
- Low noise switching

Applications:

- Rectifiers in switch mode power supplies (SMPS)
- Free wheeling diode in low voltage converters

Package: TO-262 (I2Pak)

- Industry standard outline
- RoHS compliant
- Epoxy meets UL 94V-0

Disclaimer Notice

Information furnished is believed to be accurate and reliable. However, users should independently evaluate the suitability of and test each product selected for their own applications. Littelfuse products are not designed for, and may not be used in, all applications. Read complete Disclaimer Notice at www.littelfuse.com/disclaimer-electronics.



Schottky				Ratings			
Symbol	Definition	Conditions		min.	typ.	max.	Unit
V_{RSM}	max. non-repetitive reverse blocking voltage					200	V
V_{RRM}	max. repetitive reverse blocking voltage					200	V
I_R	reverse current, drain current	$V_R = 200\text{ V}$		$T_{VJ} = 25^\circ\text{C}$		250	μA
		$V_R = 200\text{ V}$		$T_{VJ} = 125^\circ\text{C}$		2.5	mA
V_F	forward voltage drop	$I_F = 15\text{ A}$		$T_{VJ} = 25^\circ\text{C}$		0.94	V
		$I_F = 30\text{ A}$				1.10	V
		$I_F = 15\text{ A}$		$T_{VJ} = 125^\circ\text{C}$		0.78	V
		$I_F = 30\text{ A}$				0.95	V
I_{FAV}	average forward current	$T_C = 155^\circ\text{C}$	rectangular	$T_{VJ} = 175^\circ\text{C}$		15	A
V_{F0}	threshold voltage	} for power loss calculation only		$T_{VJ} = 175^\circ\text{C}$		0.53	V
r_F	slope resistance					10.8	m Ω
R_{thJC}	thermal resistance junction to case					1.75	K/W
R_{thCH}	thermal resistance case to heatsink				0.50		K/W
P_{tot}	total power dissipation			$T_C = 25^\circ\text{C}$		85	W
I_{FSM}	max. forward surge current	$t = 10\text{ ms}; (50\text{ Hz}), \text{ sine}; V_R = 0\text{ V}$		$T_{VJ} = 45^\circ\text{C}$		320	A
C_J	junction capacitance	$V_R = 48\text{ V}$	$f = 1\text{ MHz}$	$T_{VJ} = 25^\circ\text{C}$		47	pF



Package TO-262 (I2Pak)			Ratings			
Symbol	Definition	Conditions	min.	typ.	max.	Unit
I_{RMS}	RMS current	per terminal ¹⁾			35	A
T_{VJ}	virtual junction temperature		-55		175	°C
T_{op}	operation temperature		-55		150	°C
T_{stg}	storage temperature		-55		150	°C
Weight				1.5		g
F_c	mounting force with clip		20		60	N

Product Marking

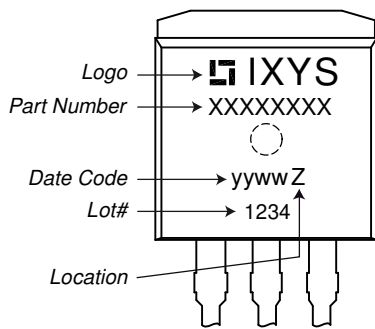

Part description

- D = Diode
- S = Schottky Diode
- A = low VF
- 30 = Current Rating [A]
- C = Common Cathode
- 200 = Reverse Voltage [V]
- IB = TO-262 (I2Pak) (3)

Ordering	Ordering Number	Marking on Product	Delivery Mode	Quantity	Code No.
Standard	DSA30C200IB	DSA30C200IB	Tube	50	512200

Similar Part	Package	Voltage class
DSA30C200PB	TO-220AB (3)	200
DSA30C200PC	TO-263AB (D2Pak) (2)	200

Equivalent Circuits for Simulation

** on die level*

$T_{VJ} = 175\text{°C}$

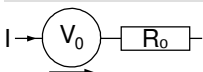

Schottky

$V_{0\ max}$	threshold voltage	0.53	V
$R_{0\ max}$	slope resistance *	7.6	mΩ



Outlines TO-262 (I2Pak)

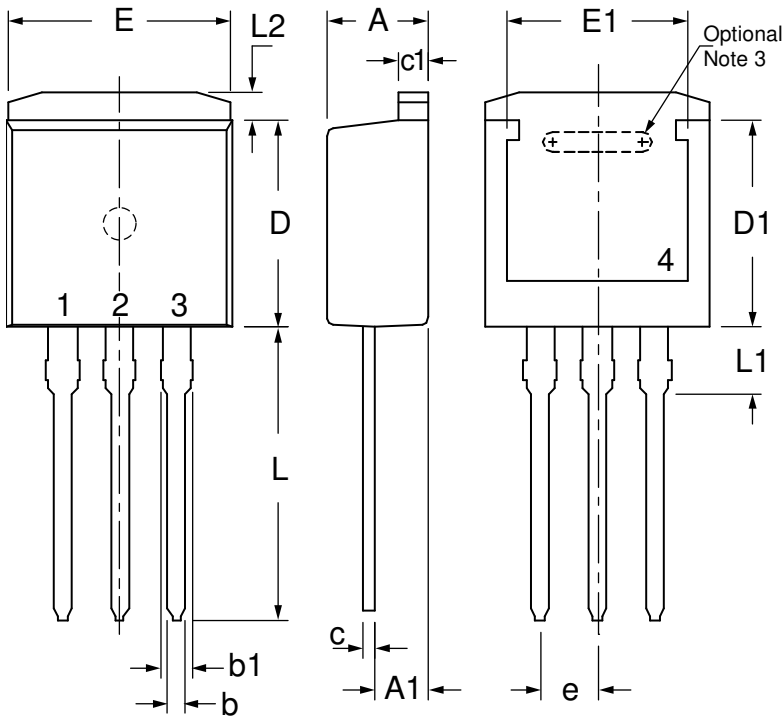

SYM	INCHES		MILLIMETERS	
	MIN	MAX	MIN	MAX
A	.160	.190	4.06	4.83
A1	.080	.110	2.03	2.79
b	.025	.035	0.64	0.88
b1	.025	.039	1.14	1.40
c	.018	.025	0.46	0.64
c1	.045	.055	1.14	1.40
D	.340	.380	8.64	9.65
D1	.270	.290	6.86	7.37
E	.380	.405	9.65	10.29
E1	.245	.320	6.22	8.13
e	.100 BSC		2.54 BSC	
L	.500	.560	12.70	14.22
L1	.100	.125	2.54	3.18
L2	.040	.055	1.02	1.40

NOTE:

1. This drawing will meet all dimensions requirement of JEDEC outline TO-262 AA.
2. All metal surface are matte pure tin plated except trimmed area.
3. Inter locking slot depends upon frame type.

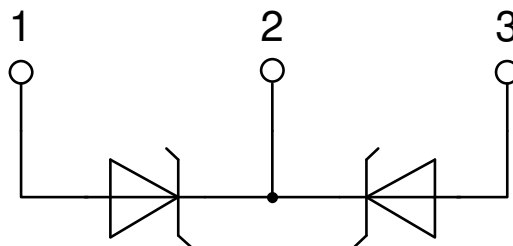



Schottky

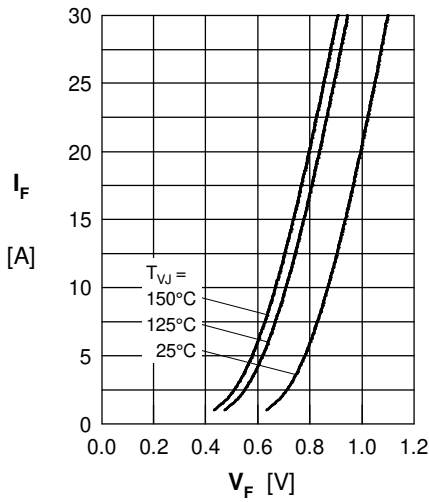

Fig. 1 Maximum forward voltage drop characteristics

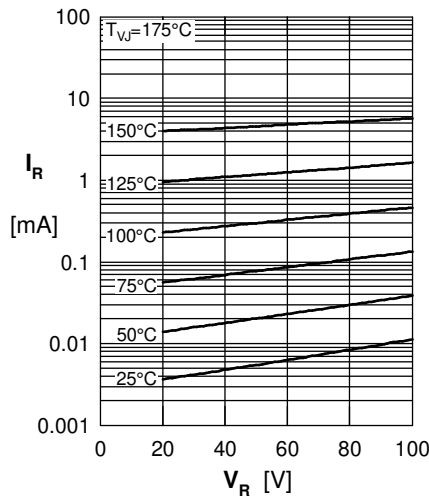

Fig. 2 Typ. reverse current I_R vs. reverse voltage V_R

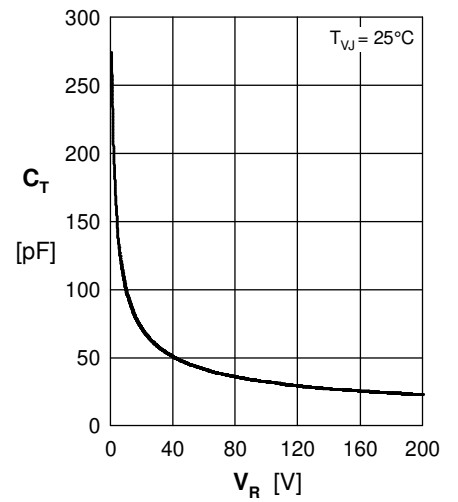

Fig. 3 Typ. junction capacitance C_T vs. reverse voltage V_R

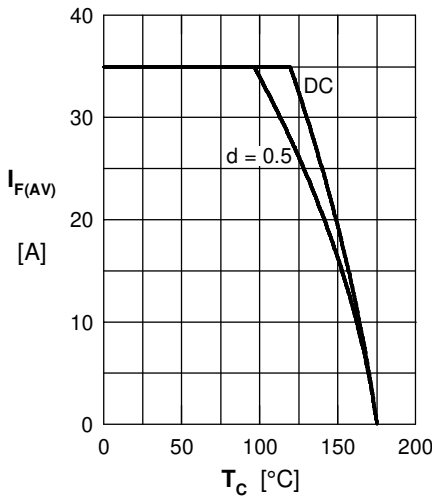

Fig. 4 Average forward current $I_{F(AV)}$ vs. case temperature T_C

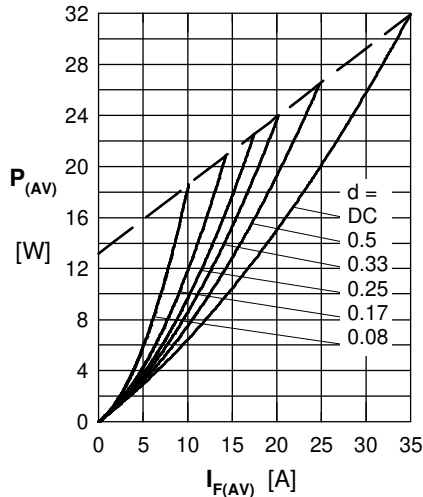

Fig. 5 Forward power loss characteristics

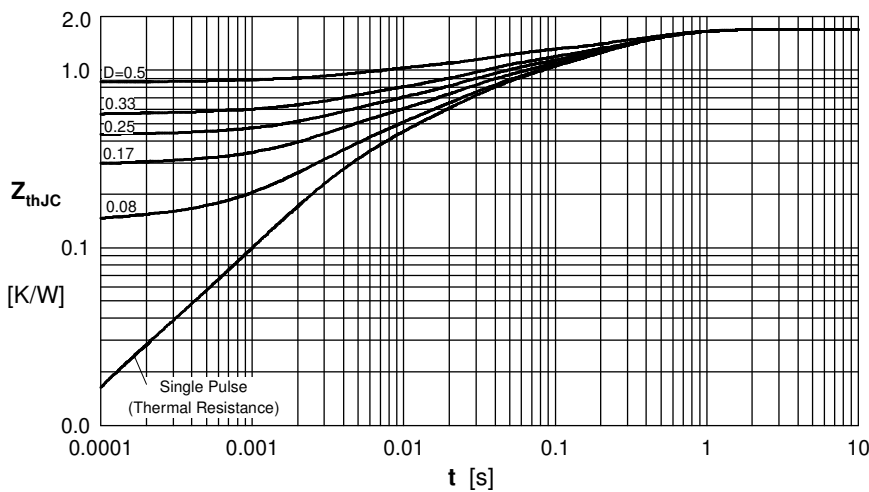

Fig. 6 Transient thermal impedance junction to case

Note: All curves are per diode



Компания «ЭлектроПласт» предлагает заключение долгосрочных отношений при поставках импортных электронных компонентов на взаимовыгодных условиях!

Наши преимущества:

- Оперативные поставки широкого спектра электронных компонентов отечественного и импортного производства напрямую от производителей и с крупнейших мировых складов;
- Поставка более 17-ти миллионов наименований электронных компонентов;
- Поставка сложных, дефицитных, либо снятых с производства позиций;
- Оперативные сроки поставки под заказ (от 5 рабочих дней);
- Экспресс доставка в любую точку России;
- Техническая поддержка проекта, помощь в подборе аналогов, поставка прототипов;
- Система менеджмента качества сертифицирована по Международному стандарту ISO 9001;
- Лицензия ФСБ на осуществление работ с использованием сведений, составляющих государственную тайну;
- Поставка специализированных компонентов (Xilinx, Altera, Analog Devices, Intersil, Interpoint, Microsemi, Aeroflex, Peregrine, Syfer, Eurofarad, Texas Instrument, Miteq, Cobham, E2V, MA-COM, Hittite, Mini-Circuits, General Dynamics и др.);

Помимо этого, одним из направлений компании «ЭлектроПласт» является направление «Источники питания». Мы предлагаем Вам помощь Конструкторского отдела:

- Подбор оптимального решения, техническое обоснование при выборе компонента;
- Подбор аналогов;
- Консультации по применению компонента;
- Поставка образцов и прототипов;
- Техническая поддержка проекта;
- Защита от снятия компонента с производства.



Как с нами связаться

Телефон: 8 (812) 309 58 32 (многоканальный)

Факс: 8 (812) 320-02-42

Электронная почта: org@eplast1.ru

Адрес: 198099, г. Санкт-Петербург, ул. Калинина, дом 2, корпус 4, литера А.