

General Description

MIC4420, MIC4429 and MIC429 MOSFET drivers are tough, efficient, and easy to use. The MIC4429 and MIC429 are inverting drivers, while the MIC4420 is a non-inverting driver.

They are capable of 6A (peak) output and can drive the largest MOSFETs with an improved safe operating margin. The MIC4420/4429/429 accepts any logic input from 2.4V to V_S without external speed-up capacitors or resistor networks. Proprietary circuits allow the input to swing negative by as much as 5V without damaging the part. Additional circuits protect against damage from electrostatic discharge.

MIC4420/4429/429 drivers can replace three or more discrete components, reducing PCB area requirements, simplifying product design, and reducing assembly cost.

Modern BiCMOS/DMOS construction guarantees freedom from latch-up. The rail-to-rail swing capability insures adequate gate voltage to the MOSFET during power up/down sequencing.

Note: See MIC4120/4129 for high power and narrow pulse applications.

Features

- CMOS Construction
- Latch-Up Protected: Will Withstand $>500\text{mA}$ Reverse Output Current
- Logic Input Withstands Negative Swing of Up to 5V
- Matched Rise and Fall Times 25ns
- High Peak Output Current 6A Peak
- Wide Operating Range 4.5V to 18V
- High Capacitive Load Drive 10,000pF
- Low Delay Time 55ns Typ
- Logic High Input for Any Voltage From 2.4V to V_S
- Low Equivalent Input Capacitance (typ) 6pF
- Low Supply Current 450 μA With Logic 1 Input
- Low Output Impedance 2.5 Ω
- Output Voltage Swing Within 25mV of Ground or V_S

Applications

- Switch Mode Power Supplies
- Motor Controls
- Pulse Transformer Driver
- Class-D Switching Amplifiers

Functional Diagram



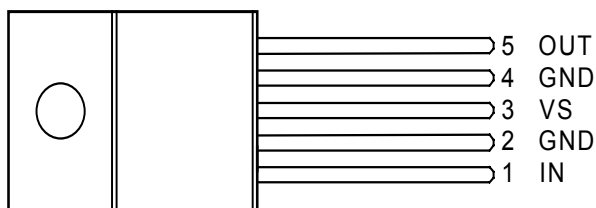
Ordering Information

Part No.		Temperature Range	Package	Configuration
Standard	Pb-Free			
MIC4420CN	MIC4420ZN	0°C to +70°C	8-Pin PDIP	Non-Inverting
MIC4420BN	MIC4420YN	-40°C to +85°C	8-Pin PDIP	Non-Inverting
MIC4420CM	MIC4420ZM	0°C to +70°C	8-Pin SOIC	Non-Inverting
MIC4420BM	MIC4420YM	-40°C to +85°C	8-Pin SOIC	Non-Inverting
MIC4420BMM	MIC4420YMM	-40°C to +85°C	8-Pin MSOP	Non-Inverting
MIC4420CT	MIC4420ZT	0°C to +70°C	5-Pin TO-220	Non-Inverting
MIC4429CN	MIC4429ZN	0°C to +70°C	8-Pin PDIP	Inverting
MIC4429BN	MIC4429YN	-40°C to +85°C	8-Pin PDIP	Inverting
MIC4429CM	MIC4429ZM	0°C to +70°C	8-Pin SOIC	Inverting
MIC4429BM	MIC4429YM	-40°C to +85°C	8-Pin SOIC	Inverting
MIC4429BMM	MIC4429YMM	-40°C to +85°C	8-Pin MSOP	Inverting
MIC4429CT	MIC4429ZT	0°C to +70°C	5-Pin TO-220	Inverting

Pin Configurations



Plastic DIP (N)
SOIC (M)
MSOP (MM)



TO-220-5 (T)

Pin Description

Pin Number TO-220-5	Pin Number DIP, SOIC, MSOP	Pin Name	Pin Function
1	2	IN	Control Input
2, 4	4, 5	GND	Ground: Duplicate pins must be externally connected together.
3, TAB	1, 8	V_S	Supply Input: Duplicate pins must be externally connected together.
5	6, 7	OUT	Output: Duplicate pins must be externally connected together.
	3	NC	Not connected.

Absolute Maximum Ratings (Notes 1, 2 and 3)

Supply Voltage	20V
Input Voltage	$V_S + 0.3V$ to GND – 5V
Input Current ($V_{IN} > V_S$)	50mA
Power Dissipation, $T_A \leq 25^\circ C$	
PDIP	960W
SOIC	1040mW
5-Pin TO-220	2W
Power Dissipation, $T_C \leq 25^\circ C$	
5-Pin TO-220	12.5W
Derating Factors (to Ambient)	
PDIP	7.7mW/ $^\circ C$
SOIC	8.3mW/ $^\circ C$
5-Pin TO-220	17mW/ $^\circ C$
Storage Temperature	$-65^\circ C$ to $+150^\circ C$
Lead Temperature (10 sec.)	$300^\circ C$

Operating Ratings

Supply Voltage	4.5V to 18V
Junction Temperature	$150^\circ C$
Ambient Temperature	
C Version	$0^\circ C$ to $+70^\circ C$
B Version	$-40^\circ C$ to $+85^\circ C$
Package Thermal Resistance	
5-pin TO-220 (θ_{JC})	$10^\circ C/W$
8-pin MSOP (θ_{JA})	$250^\circ C/W$

Electrical Characteristics: ($T_A = 25^\circ C$ with $4.5V \leq V_S \leq 18V$ unless otherwise specified. Note 4.)

Symbol	Parameter	Conditions	Min	Typ	Max	Units
INPUT						
V_{IH}	Logic 1 Input Voltage		2.4	1.4		V
V_{IL}	Logic 0 Input Voltage			1.1	0.8	V
V_{IN}	Input Voltage Range		-5		$V_S + 0.3$	V
I_{IN}	Input Current	$0V \leq V_{IN} \leq V_S$	-10		10	μA
OUTPUT						
V_{OH}	High Output Voltage	See Figure 1	$V_S - 0.025$			V
V_{OL}	Low Output Voltage	See Figure 1			0.025	V
R_O	Output Resistance, Output Low	$I_{OUT} = 10\text{ mA}, V_S = 18\text{ V}$		1.7	2.8	Ω
R_O	Output Resistance, Output High	$I_{OUT} = 10\text{ mA}, V_S = 18\text{ V}$		1.5	2.5	Ω
I_{PK}	Peak Output Current	$V_S = 18\text{ V}$ (See Figure 6)		6		A
I_R	Latch-Up Protection Withstand Reverse Current		>500			mA
SWITCHING TIME (Note 3)						
t_R	Rise Time	Test Figure 1, $C_L = 2500\text{ pF}$		12	35	ns
t_F	Fall Time	Test Figure 1, $C_L = 2500\text{ pF}$		13	35	ns
t_{D1}	Delay Time	Test Figure 1		18	75	ns
t_{D2}	Delay Time	Test Figure 1		48	75	ns
POWER SUPPLY						
I_S	Power Supply Current	$V_{IN} = 3\text{ V}$ $V_{IN} = 0\text{ V}$		0.45 90	1.5 150	mA μA
V_S	Operating Input Voltage		4.5		18	V

Electrical Characteristics: ($T_A = -55^{\circ}\text{C}$ to $+125^{\circ}\text{C}$ with $4.5\text{V} \leq V_S \leq 18\text{V}$ unless otherwise specified.)

Symbol	Parameter	Conditions	Min	Typ	Max	Units
INPUT						
V_{IH}	Logic 1 Input Voltage		2.4			V
V_{IL}	Logic 0 Input Voltage				0.8	V
V_{IN}	Input Voltage Range		-5		$V_S + 0.3$	V
I_{IN}	Input Current	$0\text{V} \leq V_{IN} \leq V_S$	-10		10	μA
OUTPUT						
V_{OH}	High Output Voltage	Figure 1	$V_S - 0.025$			V
V_{OL}	Low Output Voltage	Figure 1			0.025	V
R_O	Output Resistance, Output Low	$I_{OUT} = 10\text{mA}, V_S = 18\text{V}$		3	5	Ω
R_O	Output Resistance, Output High	$I_{OUT} = 10\text{mA}, V_S = 18\text{V}$		2.3	5	Ω
SWITCHING TIME (Note 3)						
t_R	Rise Time	Figure 1, $C_L = 2500\text{pF}$		32	60	ns
t_F	Fall Time	Figure 1, $C_L = 2500\text{pF}$		34	60	ns
t_{D1}	Delay Time	Figure 1		50	100	ns
t_{D2}	Delay Time	Figure 1		65	100	ns
POWER SUPPLY						
I_S	Power Supply Current	$V_{IN} = 3\text{V}$ $V_{IN} = 0\text{V}$		0.45 0.06	3.0 0.4	mA mA
V_S	Operating Input Voltage		4.5		18	V

Note 1: Functional operation above the absolute maximum stress ratings is not implied.

Note 2: Static-sensitive device. Store only in conductive containers. Handling personnel and equipment should be grounded to prevent damage from static discharge.

Note 3: Switching times guaranteed by design.

Note 4: Specification for packaged product only.

Test Circuits



Figure 1. Inverting Driver Switching Time

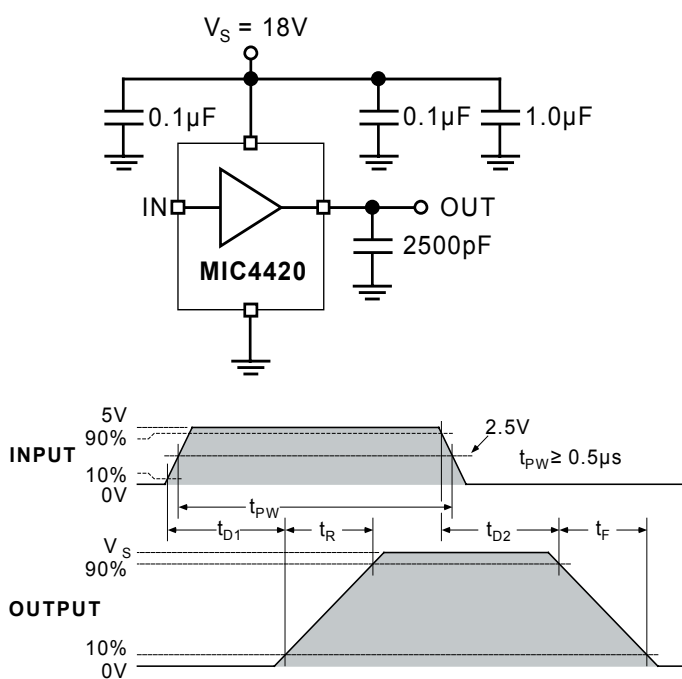
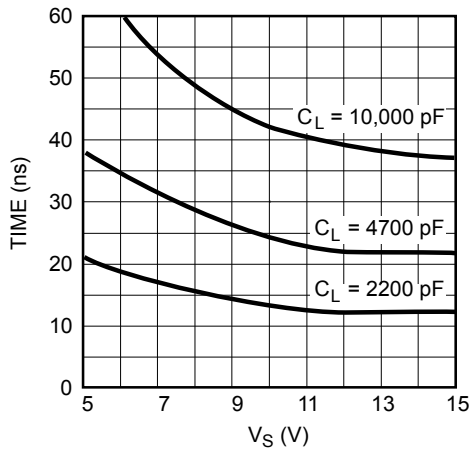


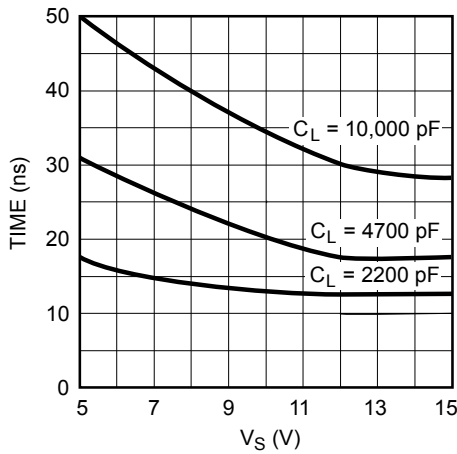
Figure 2. Noninverting Driver Switching Time

Typical Characteristic Curves

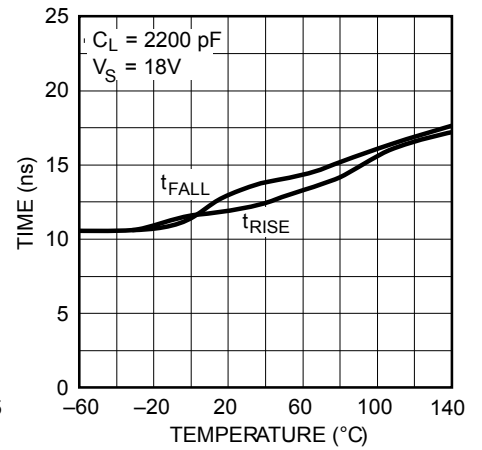
Rise Time vs. Supply Voltage



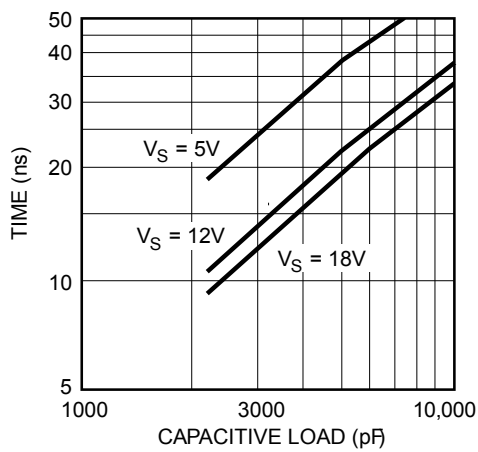
Fall Time vs. Supply Voltage



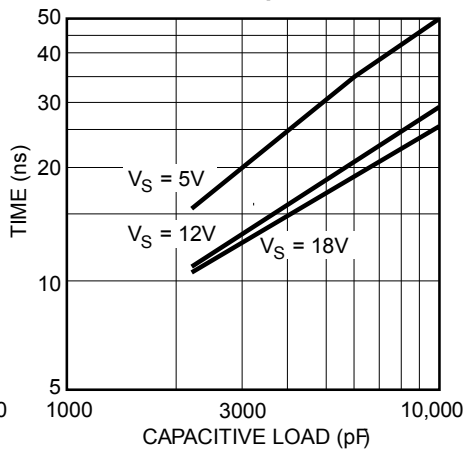
Rise and Fall Times vs. Temperature



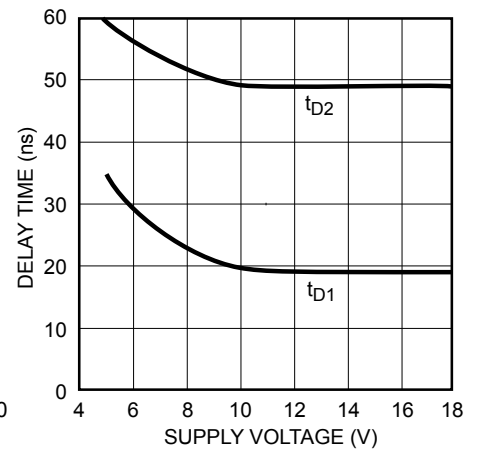
Rise Time vs. Capacitive Load



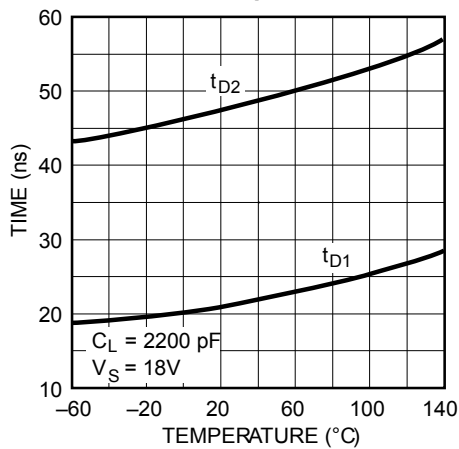
Fall Time vs. Capacitive Load



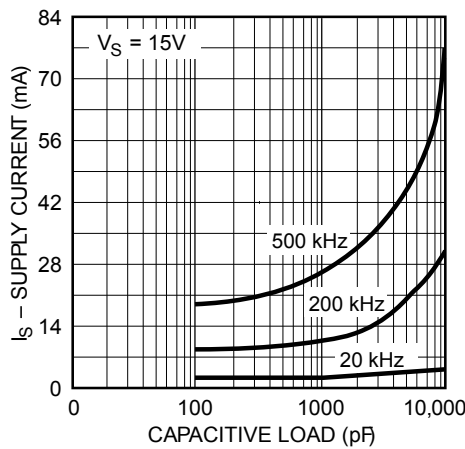
Delay Time vs. Supply Voltage



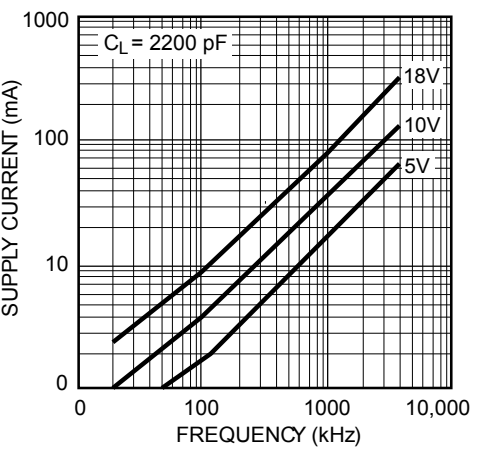
Propagation Delay Time vs. Temperature



Supply Current vs. Capacitive Load

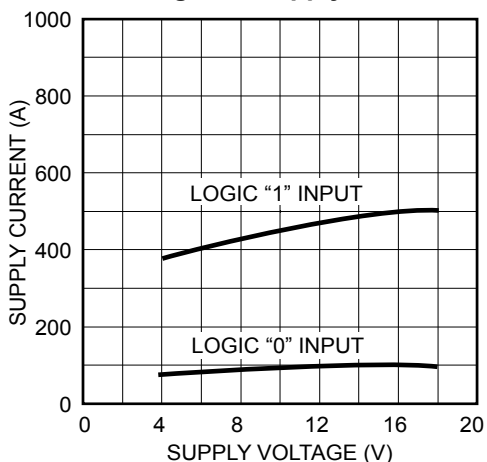


Supply Current vs. Frequency

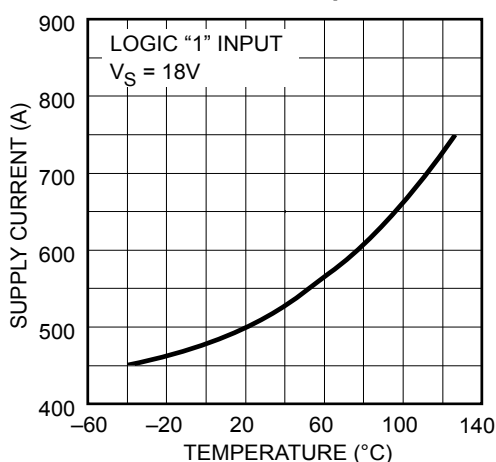


Typical Characteristic Curves (Cont.)

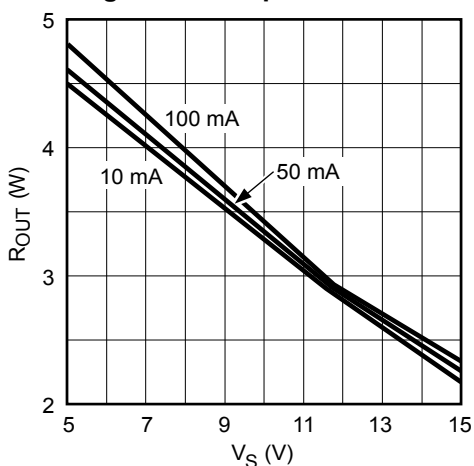
Quiescent Power Supply Voltage vs. Supply Current



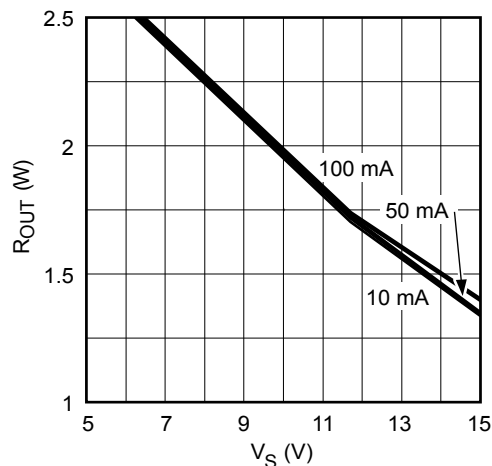
Quiescent Power Supply Current vs. Temperature



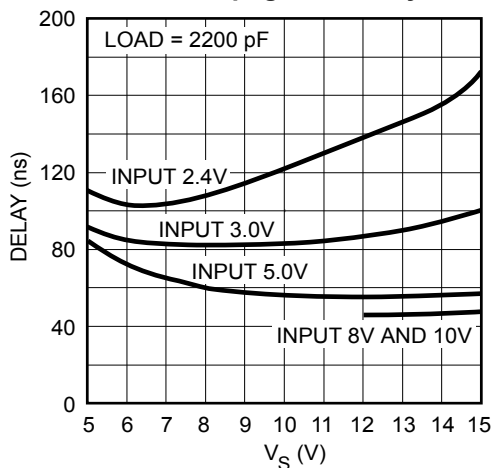
High-State Output Resistance



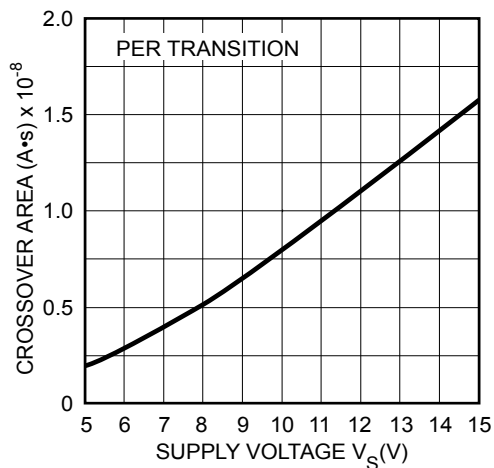
Low-State Output Resistance



Effect of Input Amplitude on Propagation Delay



Crossover Area vs. Supply Voltage



Applications Information

Supply Bypassing

Charging and discharging large capacitive loads quickly requires large currents. For example, charging a 2500pF load to 18V in 25ns requires a 1.8A current from the device power supply.

The MIC4420/4429 has double bonding on the supply pins, the ground pins and output pins. This reduces parasitic lead inductance. Low inductance enables large currents to be switched rapidly. It also reduces internal ringing that can cause voltage breakdown when the driver is operated at or near the maximum rated voltage.

Internal ringing can also cause output oscillation due to feedback. This feedback is added to the input signal since it is referenced to the same ground.

To guarantee low supply impedance over a wide frequency range, a parallel capacitor combination is recommended for supply bypassing. Low inductance ceramic disk capacitors with short lead lengths (< 0.5 inch) should be used. A 1µF low ESR film capacitor in parallel with two 0.1 µF low ESR ceramic capacitors, (such as AVX RAM GUARD®), provides adequate bypassing. Connect one ceramic capacitor directly between pins 1 and 4. Connect the second ceramic capacitor directly between pins 8 and 5.

Grounding

The high current capability of the MIC4420/4429 demands careful PC board layout for best performance. Since the MIC4429 is an inverting driver, any ground lead impedance will appear as negative feedback which can degrade switching speed. Feedback is especially noticeable with slow-rise time inputs. The MIC4429 input structure includes 300mV of hysteresis to ensure clean transitions and freedom from oscillation, but attention to layout is still recommended.

Figure 3 shows the feedback effect in detail. As the MIC4429 input begins to go positive, the output goes negative and several amperes of current flow in the ground lead. As little as 0.05Ω of PC trace resistance can produce hundreds of millivolts at the MIC4429 ground pins. If the driving logic is referenced to power ground, the effective logic input level is reduced and oscillation may result.

To insure optimum performance, separate ground traces should be provided for the logic and power connections. Connecting the logic ground directly to the MIC4429 GND pins will ensure full logic drive to the input and ensure fast output switching. Both of the MIC4429 GND pins should, however, still be connected to power ground.

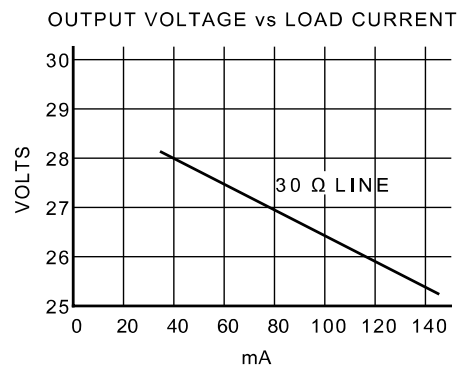
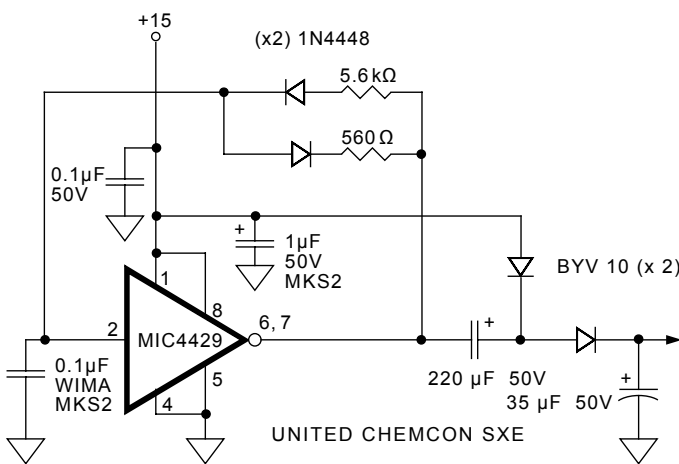


Figure 3. Self-Contained Voltage Doubler

Input Stage

The input voltage level of the 4429 changes the quiescent supply current. The N channel MOSFET input stage transistor drives a 450µA current source load. With a logic “1” input, the maximum quiescent supply current is 450µA. Logic “0” input level signals reduce quiescent current to 55µA maximum.

The MIC4420/4429 input is designed to provide 300mV of hysteresis. This provides clean transitions, reduces noise sensitivity, and minimizes output stage current spiking when changing states. Input voltage threshold level is approximately 1.5V, making the device TTL compatible over the 4.5V to 18V operating supply voltage range. Input current is less than 10µA over this range.

The MIC4429 can be directly driven by the TL494, SG1526/1527, SG1524, TSC170, MIC38HC42 and similar switch mode power supply integrated circuits. By offloading the power-driving duties to the MIC4420/4429, the power supply controller can operate at lower dissipation. This can improve performance and reliability.

The input can be greater than the +V_S supply, however, current will flow into the input lead. The propagation delay for T_{D2} will increase to as much as 400ns at room temperature. The input currents can be as high as 30mA p-p (6.4mA_{RMS}) with the input, 6 V greater than the supply voltage. No damage will occur to MIC4420/4429 however, and it will not latch.

The input appears as a 7pF capacitance, and does not change even if the input is driven from an AC source. Care should be taken so that the input does not go more than 5 volts below the negative rail.

Power Dissipation

CMOS circuits usually permit the user to ignore power dissipation. Logic families such as 4000 and 74C have outputs which can only supply a few milliamperes of current, and even shorting outputs to ground will not force enough current to destroy the device. The MIC4420/4429 on the other hand, can source or sink several amperes and drive large capacitive loads at high frequency. The package power dissipation limit can easily be exceeded. Therefore, some

attention should be given to power dissipation when driving low impedance loads and/or operating at high frequency.

The supply current vs frequency and supply current vs capacitive load characteristic curves aid in determining power dissipation calculations. Table 1 lists the maximum safe operating frequency for several power supply voltages when driving a 2500pF load. More accurate power dissipation figures can be obtained by summing the three dissipation sources.

Given the power dissipation in the device, and the thermal resistance of the package, junction operating temperature for any ambient is easy to calculate. For example, the thermal resistance of the 8-pin MSOP package, from the data sheet, is 250°C/W. In a 25°C ambient, then, using a maximum junction temperature of 150°C, this package will dissipate 500mW.

Accurate power dissipation numbers can be obtained by summing the three sources of power dissipation in the device:

- Load Power Dissipation (P_L)
- Quiescent power dissipation (P_Q)
- Transition power dissipation (P_T)

Calculation of load power dissipation differs depending on whether the load is capacitive, resistive or inductive.

Resistive Load Power Dissipation

Dissipation caused by a resistive load can be calculated as:

$$P_L = I^2 R_O D$$

where:

- I = the current drawn by the load
- R_O = the output resistance of the driver when the output is high, at the power supply voltage used. (See data sheet)
- D = fraction of time the load is conducting (duty cycle)

Table 1: MIC4429 Maximum Operating Frequency

V _S	Max Frequency
18V	500kHz
15V	700kHz
10V	1.6MHz

Conditions:
 1. DIP Package (θ_{JA} = 130°C/W)
 2. T_A = 25°C
 3. C_L = 2500pF

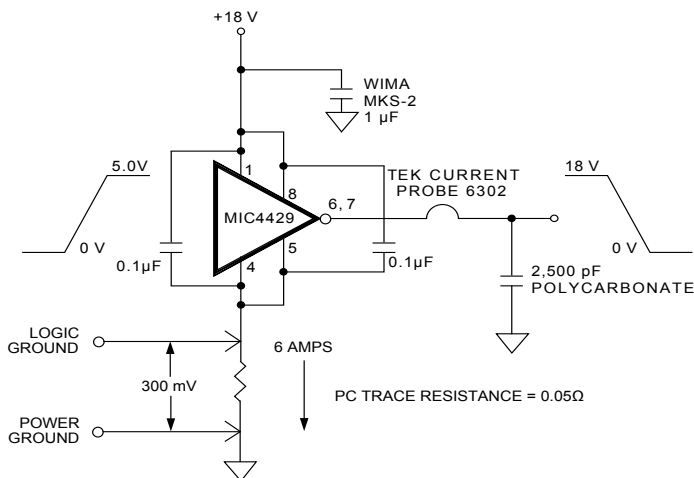


Figure 4. Switching Time Degradation Due to Negative Feedback

Capacitive Load Power Dissipation

Dissipation caused by a capacitive load is simply the energy placed in, or removed from, the load capacitance by the driver. The energy stored in a capacitor is described by the equation:

$$E = 1/2 C V^2$$

As this energy is lost in the driver each time the load is charged or discharged, for power dissipation calculations the 1/2 is removed. This equation also shows that it is good practice not to place more voltage on the capacitor than is necessary, as dissipation increases as the square of the voltage applied to the capacitor. For a driver with a capacitive load:

$$P_L = f C (V_S)^2$$

where:

f = Operating Frequency
C = Load Capacitance
V_S = Driver Supply Voltage

Inductive Load Power Dissipation

For inductive loads the situation is more complicated. For the part of the cycle in which the driver is actively forcing current into the inductor, the situation is the same as it is in the resistive case:

$$P_{L1} = I^2 R_O D$$

However, in this instance the R_O required may be either the on resistance of the driver when its output is in the high state, or its on resistance when the driver is in the low state, depending on how the inductor is connected, and this is still only half the story. For the part of the cycle when the inductor is forcing current through the driver, dissipation is best described as

$$P_{L2} = I V_D (1-D)$$

where V_D is the forward drop of the clamp diode in the driver (generally around 0.7V). The two parts of the load dissipation must be summed in to produce P_L

$$P_L = P_{L1} + P_{L2}$$

Quiescent Power Dissipation

Quiescent power dissipation (P_Q, as described in the input section) depends on whether the input is high or low. A low input will result in a maximum current drain (per driver) of ≤0.2mA; a logic high will result in a current drain of ≤2.0mA. Quiescent power can therefore be found from:

$$P_Q = V_S [D I_H + (1-D) I_L]$$

where:

I_H = quiescent current with input high
I_L = quiescent current with input low
D = fraction of time input is high (duty cycle)
V_S = power supply voltage

Transition Power Dissipation

Transition power is dissipated in the driver each time its output changes state, because during the transition, for a very brief interval, both the N- and P-channel MOSFETs in the output totem-pole are ON simultaneously, and a current is conducted through them from V_S⁺ to ground. The transition power dissipation is approximately:

$$P_T = 2 f V_S (A \cdot s)$$

where (A·s) is a time-current factor derived from the typical characteristic curves.

Total power (P_D) then, as previously described is:

$$P_D = P_L + P_Q + P_T$$

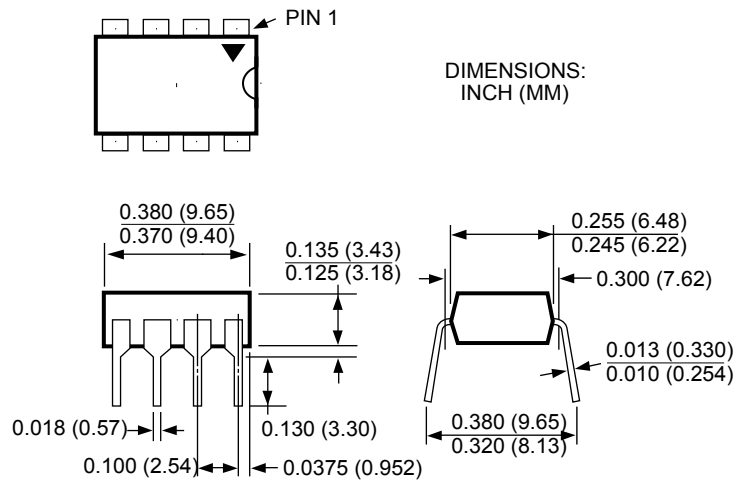
Definitions

C_L = Load Capacitance in Farads.
D = Duty Cycle expressed as the fraction of time the input to the driver is high.
f = Operating Frequency of the driver in Hertz
I_H = Power supply current drawn by a driver when both inputs are high and neither output is loaded.
I_L = Power supply current drawn by a driver when both inputs are low and neither output is loaded.
I_D = Output current from a driver in Amps.
P_D = Total power dissipated in a driver in Watts.
P_L = Power dissipated in the driver due to the driver's load in Watts.
P_Q = Power dissipated in a quiescent driver in Watts.
P_T = Power dissipated in a driver when the output changes states ("shoot-through current") in Watts. NOTE: The "shoot-through" current from a dual transition (once up, once down) for both drivers is shown by the "Typical Characteristic Curve : Crossover Area vs. Supply Voltage and is in ampere-seconds. This figure must be multiplied by the number of repetitions per second (frequency) to find Watts.
R_O = Output resistance of a driver in Ohms.
V_S = Power supply voltage to the IC in Volts.

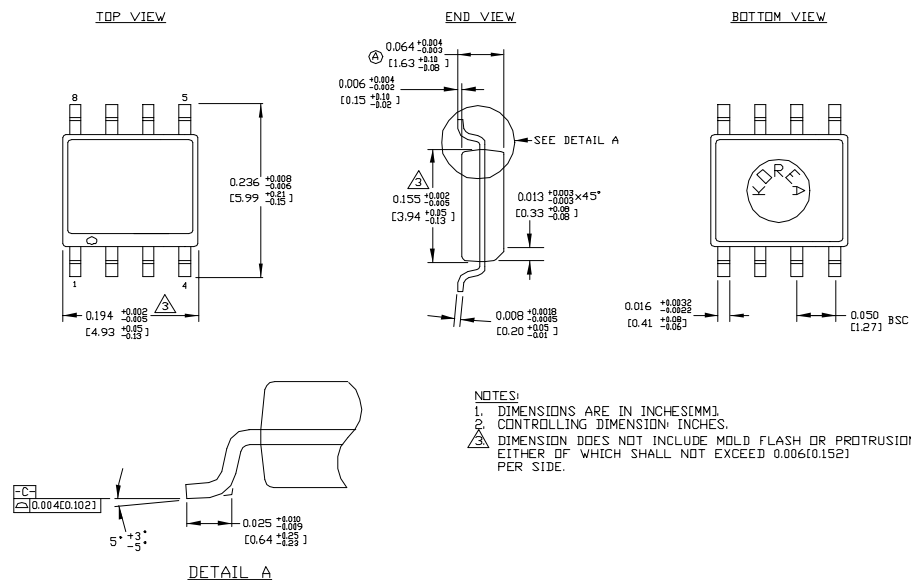


Figure 5. Peak Output Current Test Circuit

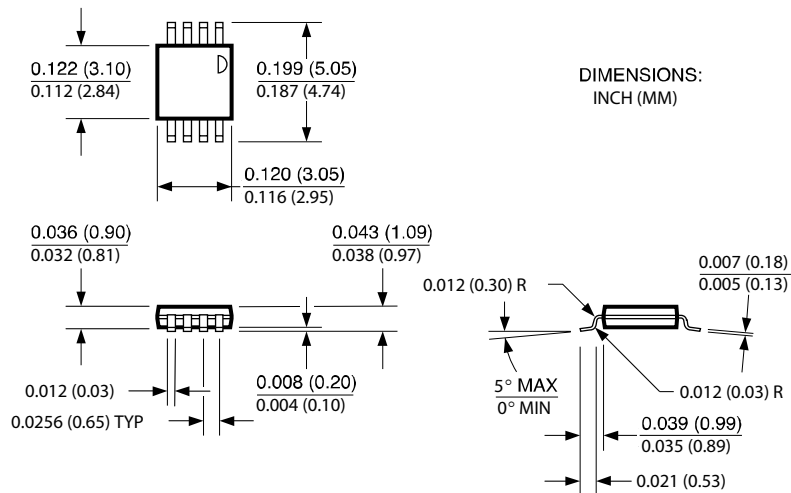
Package Information



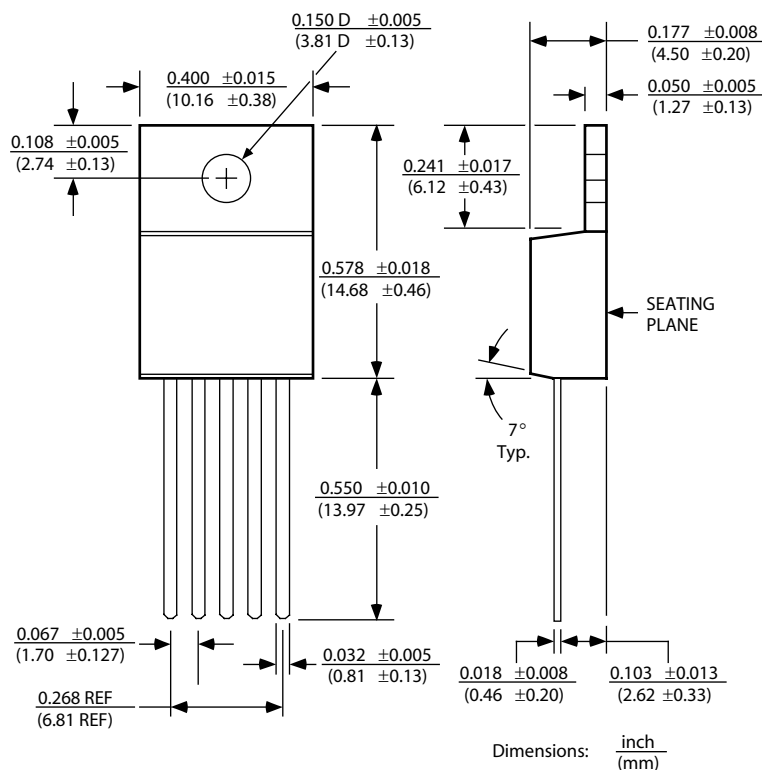
8-Pin Plastic DIP (N)



8-Pin SOIC (M)



8-Pin MSOP (MM)



5-Lead TO-220 (T)

MICREL INC. 2180 FORTUNE DRIVE SAN JOSE, CA 95131 USA
TEL + 1 (408) 944-0800 FAX + 1 (408) 474-1000 WEB <http://www.micrel.com>

This information furnished by Micrel in this data sheet is believed to be accurate and reliable. However no responsibility is assumed by Micrel for its use. Micrel reserves the right to change circuitry and specifications at any time without notification to the customer.

Micrel Products are not designed or authorized for use as components in life support appliances, devices or systems where malfunction of a product can reasonably be expected to result in personal injury. Life support devices or systems are devices or systems that (a) are intended for surgical implant into the body or (b) support or sustain life, and whose failure to perform can be reasonably expected to result in a significant injury to the user. A Purchaser's use or sale of Micrel Products for use in life support appliances, devices or systems is a Purchaser's own risk and Purchaser agrees to fully indemnify Micrel for any damages resulting from such use or sale.

© 2001 Micrel, Inc.



Компания «ЭлектроПласт» предлагает заключение долгосрочных отношений при поставках импортных электронных компонентов на взаимовыгодных условиях!

Наши преимущества:

- Оперативные поставки широкого спектра электронных компонентов отечественного и импортного производства напрямую от производителей и с крупнейших мировых складов;
- Поставка более 17-ти миллионов наименований электронных компонентов;
- Поставка сложных, дефицитных, либо снятых с производства позиций;
- Оперативные сроки поставки под заказ (от 5 рабочих дней);
- Экспресс доставка в любую точку России;
- Техническая поддержка проекта, помощь в подборе аналогов, поставка прототипов;
- Система менеджмента качества сертифицирована по Международному стандарту ISO 9001;
- Лицензия ФСБ на осуществление работ с использованием сведений, составляющих государственную тайну;
- Поставка специализированных компонентов (Xilinx, Altera, Analog Devices, Intersil, Interpoint, Microsemi, Aeroflex, Peregrine, Syfer, Eurofarad, Texas Instrument, Miteq, Cobham, E2V, MA-COM, Hittite, Mini-Circuits, General Dynamics и др.);

Помимо этого, одним из направлений компании «ЭлектроПласт» является направление «Источники питания». Мы предлагаем Вам помощь Конструкторского отдела:

- Подбор оптимального решения, техническое обоснование при выборе компонента;
- Подбор аналогов;
- Консультации по применению компонента;
- Поставка образцов и прототипов;
- Техническая поддержка проекта;
- Защита от снятия компонента с производства.



Как с нами связаться

Телефон: 8 (812) 309 58 32 (многоканальный)

Факс: 8 (812) 320-02-42

Электронная почта: org@eplast1.ru

Адрес: 198099, г. Санкт-Петербург, ул. Калинина, дом 2, корпус 4, литера А.