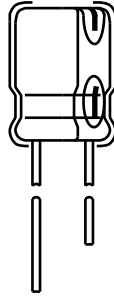

Aluminum Capacitors + 85 °C, Miniature, Radial Lead

FEATURES

- High CV per case size
- Low cost
- Low profile ratings
- Material categorization:
For definitions of compliance please see www.vishay.com/doc?99912

RoHS
COMPLIANT

| QUICK REFERENCE DATA | |
|---|--|
| DESCRIPTION | VALUE |
| Nominal case size Ø D x L in mm | 0.157" x 0.276" [4.0 x 7.0] to 0.709" x 1.575" [18.0 x 40.0] |
| Operating temperature | - 40 °C to + 85 °C - 25 °C to + 85 °C for 315 WV _{DC} to 450 WV _{DC} units |
| Rated capacitance range, C _R | 0.1 µF to 18 000 µF |
| Tolerance on C _R | ± 20 % |
| Rated voltage range, U _R | 6.3 WV _{DC} to 450 WV _{DC} |
| Termination | 2 radial leads |
| Life validation test at 85 °C | 2000 h: ΔCAP ± 20 % from initial measurement. ΔDF 2 x initial specified limit. ΔDCL ≤ initial specified limit. |
| Shelf life at 85 °C | 1000 h: ΔCAP ± 20 % from initial measurement. ΔDF 2 x initial specified limit. ΔDCL ≤ initial specified limit. |
| DC leakage current | Rated voltage for 1 and 2 min for 6.3 WV _{DC} to 100 WV _{DC} units: I < 0.03 CV or 4 µA (whichever is greater). I < 0.04 CV or 3 µA (whichever is greater). Rated voltage for 1 min for 160 WV _{DC} to 450 WV _{DC} units: I < 0.1 CV + 40 µA and CV ≤ 1000; I < 0.04 CV + 100 µA and CV > 1000 |

| RIPPLE CURRENT MULTIPLIERS | | | | | | |
|----------------------------|----------------|-------------|------------|------------|-------|----------|
| TEMPERATURE | | | | | | |
| AMBIENT TEMPERATURE | | MULTIPLIERS | | | | |
| ≤ + 70 °C | | 1.27 | | | | |
| + 85 °C | | 1.0 | | | | |
| FREQUENCY (Hz) | | | | | | |
| WV _{DC} | CAP. (µF) | 50 TO 60 | 100 TO 120 | 300 TO 400 | 1 kHz | ≤ 10 kHz |
| 6.3 to 100 | 0 to 47 | 0.75 | 1 | 1.35 | 1.57 | 2.00 |
| | 100 to 470 | 0.80 | 1 | 1.23 | 1.34 | 1.50 |
| | 1000 to 18 000 | 0.85 | 1 | 1.10 | 1.13 | 1.15 |
| 160 to 450 | 0.47 to 220 | 0.80 | 1 | 1.25 | 1.40 | 1.60 |

| LOW TEMPERATURE PERFORMANCE | | |
|---|---------------------|---------------------|
| MAXIMUM IMPEDANCE RATIO Z ^(T) /Z ^(+20 °C) | | |
| MAXIMUM AT 120 Hz | | |
| RATED VOLTAGE (WV _{DC}) | Z - 25 °C/Z + 20 °C | Z - 40 °C/Z + 20 °C |
| 6.3 | 4.0 | 10.0 |
| 10.0 | 3.0 | 8.0 |
| 16.0 | 2.0 | 6.0 |
| 25.0 | 2.0 | 4.0 |
| 35.0 to 100.0 | 2.0 | 3.0 |
| 160.0 to 200.0 | 3.0 | 4.0 |
| 250.0 | 3.0 | 6.0 |
| 315.0 to 400.0 | 6.0 | - |
| 450.0 | 15.0 | - |

| DIMENSIONS in inches [millimeters] | | | | |
|------------------------------------|----------------------------|----------------|-------------------------|--------------------|
| CASE CODE | NOMINAL CASE SIZE D x L | LEAD SPACING S | NOMINAL LEAD DIAMETER D | TYPICAL WEIGHT (g) |
| HW | 0.157 x 0.276 [4.0 x 7.0] | 0.059 [1.5] | 0.018 [0.45] | 0.20 |
| JW | 0.197 x 0.276 [5.0 x 7.0] | 0.079 [2.0] | 0.018 [0.45] | 0.30 |
| AW | 0.248 x 0.276 [6.3 x 7.0] | 0.098 [2.5] | 0.018 [0.45] | 0.40 |
| JA | 0.197 x 0.433 [5.0 x 11.0] | 0.079 [2.0] | 0.020 [0.50] | 0.44 |
| AA | 0.248 x 0.433 [6.3 x 11.0] | 0.098 [2.5] | 0.020 [0.50] | 0.60 |
| BB | 0.315 x 0.453 [8.0 x 11.5] | 0.138 [3.5] | 0.024 [0.60] | 0.95 |

| DIMENSIONS in inches [millimeters] | | | | |
|---|-----------------------------|-------------------|----------------------------|-----------------------|
| CASE CODE | NOMINAL CASE SIZE D x L | LEAD SPACING S | NOMINAL LEAD DIAMETER D | TYPICAL WEIGHT (g) |
| CC | 0.394 x 0.492 [10.0 x 12.5] | 0.197 [5.0] | 0.024 [0.60] | 1.48 |
| CD | 0.394 x 0.630 [10.0 x 16.0] | 0.197 [5.0] | 0.024 [0.60] | 1.75 |
| CG | 0.394 x 0.787 [10.0 x 20.0] | 0.197 [5.0] | 0.024 [0.60] | 2.37 |
| DG | 0.492 x 0.787 [12.5 x 20.0] | 0.197 [5.0] | 0.024 [0.60] | 3.73 |
| DK | 0.492 x 0.984 [12.5 x 25.0] | 0.197 [5.0] | 0.024 [0.60] | 4.85 |
| EK | 0.630 x 0.984 [16.0 x 25.0] | 0.295 [7.5] | 0.031 [0.80] | 7.08 |
| EN | 0.630 x 1.240 [16.0 x 31.5] | 0.295 [7.5] | 0.031 [0.80] | 8.94 |
| ER | 0.630 x 1.398 [16.0 x 35.5] | 0.295 [7.5] | 0.031 [0.80] | 10.50 |
| FR | 0.709 x 1.398 [18.0 x 35.5] | 0.295 [7.5] | 0.031 [0.80] | 12.53 |
| FV | 0.709 x 1.575 [18.0 x 40.0] | 0.295 [7.5] | 0.031 [0.80] | 15.71 |

ELECTROLYTIC CAPACITOR WITH CUT OR FORMED LEADS in inches [millimeters]

Code F

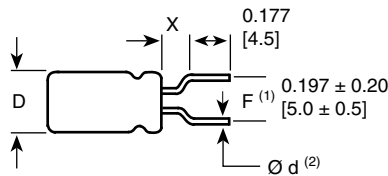

Code S

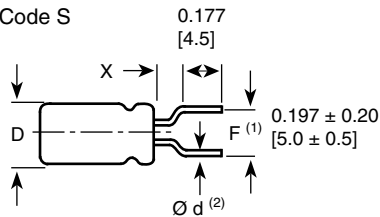

Code S

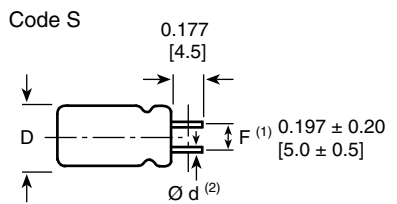

Code C

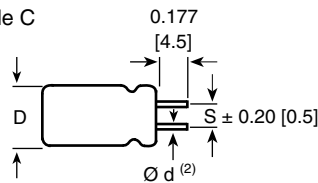

Code S

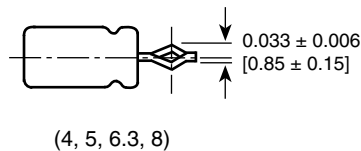

Code S



| DIMENSIONS in inches [millimeters] | | | | | | |
|---|------------------|--------------|-------------|-------------|------------------|-------------|
| FORMING METHOD | FORMED LEAD CODE | DIMENSIONS | | | | |
| | | D | L.S. | P | e ⁽³⁾ | X (Max.) |
| Formed and cut | F | 0.157 [4.0] | 0.197 [5.0] | 0.059 [1.5] | - | 0.059 [1.5] |
| | | 0.197 [5.0] | 0.197 [5.0] | 0.079 [2.0] | - | 0.059 [1.5] |
| | | 0.248 [6.3] | 0.197 [5.0] | 0.098 [2.5] | - | 0.098 [2.5] |
| | | 0.315 [8.0] | 0.197 [5.0] | 0.138 [3.5] | - | 0.098 [2.5] |
| Cut | C | 0.394 [10.0] | 0.197 [5.0] | - | - | - |
| | | 0.492 [12.5] | 0.197 [5.0] | - | - | - |
| | | 0.630 [16.0] | 0.295 [7.5] | - | - | - |
| | | 0.709 [18.0] | 0.295 [7.5] | - | - | - |
| Snap-in | S | 0.157 [4.0] | 0.197 [5.0] | 0.059 [1.5] | 0.043 [1.1] | 0.059 [1.5] |
| | | 0.197 [5.0] | 0.197 [5.0] | 0.079 [2.0] | 0.043 [1.1] | 0.059 [1.5] |
| | | 0.248 [6.3] | 0.197 [5.0] | 0.098 [2.5] | 0.043 [1.1] | 0.059 [1.5] |
| | | 0.315 [8.0] | 0.197 [5.0] | 0.138 [3.5] | 0.051 [1.3] | 0.059 [1.5] |
| | | 0.394 [10.0] | 0.197 [5.0] | - | 0.051 [1.3] | - |
| | | 0.492 [12.5] | 0.197 [5.0] | - | 0.051 [1.3] | - |
| | | 0.630 [16.0] | 0.295 [7.5] | - | 0.051 [1.3] | - |
| | | 0.709 [18.0] | 0.295 [7.5] | - | 0.051 [1.3] | - |

Notes

- Coding of cut or formed lead to be added to the end of type number in 15th position (with position 14 coded "6").
- (1) Formed lead.
- (2) Lead thickness Ø d depends on capacitor specification.
- (3) Lead protrusion at bottom of tape.

| TAPED CAPACITORS FOR AUTOMATIC INSERTION SYSTEMS in inches [millimeters] | | | | | |
|--|--|----------------------------|---------------|---------------|--|
| PACKAGING | LEAD CODE 14 th AND 15 th DIGITS OF PN | SPECIFICATION | | LEAD SPACE | CAPACITOR SIZES AVAILABLE |
| | | LEAD STYLE | + - LEADER | | |
| Ammo pack | 8P | Formed lead ⁽¹⁾ | - | 0.197 [5.0] | 0.157 x 0.276 - 0.492 x 0.787 [4.0 x 7.0 - 12.5 x 20.0] Case codes HW, JW, AW, JA, AA, BB, CC, CD, DG |

Notes

- The ammo pack code is to be added at the end of part number in the 14th and 15th position as 8P. To specify formed, cut or snap-in leads and for tape and ammo, both positions 14 and 15 of the type number must be filled in with the proper codes.
- ⁽¹⁾ Except 0.394 [10.0 mm] and 0.492 [12.5 mm] diameter have straight unformed leads.

TAPING SPECIFICATIONS in inches [millimeters]

Formed Lead Type

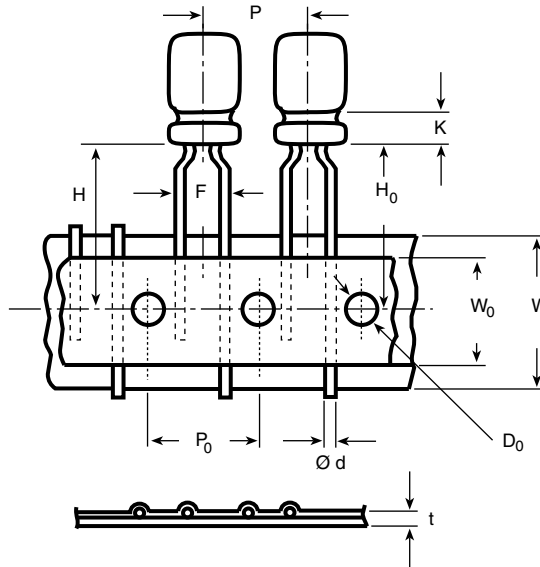

| DIMENSIONS in inches [millimeters] | | | | | | | | |
|--|----------------------------------|------------------------------|-------------------------------|------------------------------|-------------------------------|-------------------------------|------------------------|------------------------|
| ITEM | CASE SIZE (Diameter x Length) | | | | | | | |
| | FORMED LEAD TYPE | | | | | | STRAIGHT LEAD TYPE | |
| | 0.157 x 0.276 [4.0 x 7.0] | 0.197 x 0.276 [5.0 x 7.0] | 0.197 x 0.433 [5.0 x 11.0] | 0.248 x 0.276 [6.3 x 7.0] | 0.248 x 0.433 [6.3 x 11.0] | 0.315 x 0.453 [8.0 x 11.5] | 0.394 [10.0] (Dia.) | 0.492 [12.5] (Dia.) |
| Ø d - Lead-wire diameter | 0.018 [0.45] | 0.018 [0.45] | 0.020 [0.5] | 0.018 [0.45] | 0.020 [0.5] | 0.024 [0.6] | 0.024 [0.6] | 0.024 [0.6] |
| P - Pitch of component | 0.500 [12.7] | 0.500 [12.7] | 0.500 [12.7] | 0.500 [12.7] | 0.500 [12.7] | 0.500 [12.7] | 0.500 [12.7] | 0.591 [15.0] |
| P ₀ - Feed hole pitch | 0.500 [12.7] | 0.500 [12.7] | 0.500 [12.7] | 0.500 [12.7] | 0.500 [12.7] | 0.500 [12.7] | 0.500 [12.7] | 0.591 [15.0] |
| F - Lead-to-lead distance | 0.197 [5.0] | 0.197 [5.0] | 0.197 [5.0] | 0.197 [5.0] | 0.197 [5.0] | 0.197 [5.0] | 0.197 [5.0] | 0.197 [5.0] |
| K - Clinch height | 0.059 [1.5] | 0.059 [1.5] | 0.098 [2.5] | 0.059 [1.5] | 0.098 [2.5] | 0.157 [4.0] | - | - |
| H - Height of component | 0.689 [17.5] | 0.689 [17.5] | 0.728 [18.5] | 0.689 [17.5] | 0.728 [18.5] | 0.787 [20.0] | 0.728 [18.5] | 0.630 [16.0] |
| H ₀ - Lead-wire clinch height | 0.630 [16.0] | 0.630 [16.0] | 0.630 [16.0] | 0.630 [16.0] | 0.630 [16.0] | 0.630 [16.0] | - | - |
| W - Tape width | 0.709 [18.0] | 0.709 [18.0] | 0.709 [18.0] | 0.709 [18.0] | 0.709 [18.0] | 0.709 [18.0] | 0.709 [18.0] | 0.709 [18.0] |
| W ₀ - Hold down tape width | 0.512 [13.0] | 0.512 [13.0] | 0.512 [13.0] | 0.512 [13.0] | 0.512 [13.0] | 0.512 [13.0] | 0.512 [13.0] | 0.512 [13.0] |
| D ₀ - Feed hole diameter | 0.157 [4.0] | 0.157 [4.0] | 0.157 [4.0] | 0.157 [4.0] | 0.157 [4.0] | 0.157 [4.0] | 0.157 [4.0] | 0.157 [4.0] |
| t - Total tape thickness | 0.157 [4.0] | 0.157 [4.0] | 0.157 [4.0] | 0.157 [4.0] | 0.157 [4.0] | 0.157 [4.0] | 0.157 [4.0] | 0.157 [4.0] |

**ORDERING EXAMPLE**

Electrolytic capacitor 515D series: 515D 107 M 6R3 JA 6 A E3

| DESCRIPTION | |
|-------------|---------------------------------------|
| CODE | EXPLANATION |
| 515D | Product type |
| 107 | Capacitance value (100 µF) |
| M | Tolerance (M = ± 20 %) |
| 6R3 | Voltage rating at 85 °C (6R3 = 6.3 V) |
| JA | Can size (see Dimensions table) |
| 6 | Packaging (bulk) |
| A | Lead style (uncut) |
| E3 | RoHS compliant indicator |

PACKING AND LEAD STYLES

| | |
|----|---|
| 6A | Bulk, uncut leads |
| 6C | Bulk, cut leads |
| 6F | Bulk; formed and cut leads |
| 6S | Bulk, snap-in leads |
| 8P | Ammopack (case codes HW, JW, AW, JA, AA, BB, CC, CD, CG, DG only) |

| ELECTRICAL DATA AND ORDERING INFORMATION | | | | |
|--|-------------------|-----------------------------|------------------------------------|---------------------------|
| CAPACITANCE (µF) | PART NUMBER | NOMINAL CASE SIZE D x L | MAX. RIPPLE AT + 85 °C 120 Hz (mA) | MAX. DF AT + 20 °C 120 Hz |
| 6.3 WV_{DC} AT + 85 °C, SURGE = 8 V | | | | |
| 22.0 | 515D226M6R3JA6AE3 | 0.197 x 0.433 [5.0 x 11.0] | 34.0 | 0.24 |
| 33.0 | 515D336M6R3JA6AE3 | 0.197 x 0.433 [5.0 x 11.0] | 42.0 | 0.24 |
| 47.0 | 515D476M6R3JA6AE3 | 0.197 x 0.433 [5.0 x 11.0] | 50.0 | 0.24 |
| 100.0 | 515D107M6R3JA6AE3 | 0.197 x 0.433 [5.0 x 11.0] | 77.0 | 0.24 |
| 220.0 | 515D227M6R3AA6AE3 | 0.248 x 0.433 [6.3 x 11.0] | 215.0 | 0.24 |
| 330.0 | 515D337M6R3AA6AE3 | 0.248 x 0.433 [6.3 x 11.0] | 265.0 | 0.24 |
| 470.0 | 515D477M6R3BB6AE3 | 0.315 x 0.453 [8.0 x 11.5] | 360.0 | 0.24 |
| 1000.0 | 515D108M6R3CC6AE3 | 0.394 x 0.492 [10.0 x 12.5] | 570.0 | 0.24 |
| 2200.0 | 515D228M6R3DG6AE3 | 0.492 x 0.787 [12.5 x 20.0] | 1050.0 | 0.24 |
| 3300.0 | 515D338M6R3DG6AE3 | 0.492 x 0.787 [12.5 x 20.0] | 1250.0 | 0.24 |
| 4700.0 | 515D478M6R3EK6AE3 | 0.630 x 0.984 [16.0 x 25.0] | 1700.0 | 0.24 |
| 6800.0 | 515D688M6R3EK6AE3 | 0.630 x 0.984 [16.0 x 25.0] | 1900.0 | 0.24 |
| 10 000.0 | 515D109M6R3EN6AE3 | 0.630 x 1.240 [16.0 x 31.5] | 2250.0 | 0.24 |
| 15 000.0 | 515D159M6R3FR6AE3 | 0.709 x 1.398 [18.0 x 35.5] | 2680.0 | 0.24 |
| 18 000.0 | 515D189M6R3FV6AE3 | 0.709 x 1.575 [18.0 x 40.0] | 2750.0 | 0.24 |
| 10 WV_{DC} AT + 85 °C, SURGE = 13 V | | | | |
| 22.0 | 515D226M010JA6AE3 | 0.197 x 0.433 [5.0 x 11.0] | 38.0 | 0.20 |
| 33.0 | 515D336M010JA6AE3 | 0.197 x 0.433 [5.0 x 11.0] | 47.0 | 0.20 |
| 47.0 | 515D476M010JA6AE3 | 0.197 x 0.433 [5.0 x 11.0] | 59.0 | 0.20 |
| 100.0 | 515D107M010JA6AE3 | 0.197 x 0.433 [5.0 x 11.0] | 145.0 | 0.20 |
| 220.0 | 515D227M010AA6AE3 | 0.248 x 0.433 [6.3 x 11.0] | 230.0 | 0.20 |
| 330.0 | 515D337M010BB6AE3 | 0.315 x 0.453 [8.0 x 11.5] | 330.0 | 0.20 |
| 470.0 | 515D477M010BB6AE3 | 0.315 x 0.453 [8.0 x 11.5] | 390.0 | 0.20 |
| 1000.0 | 515D108M010CD6AE3 | 0.394 x 0.630 [10.0 x 16.0] | 630.0 | 0.20 |
| 2200.0 | 515D228M010DG6AE3 | 0.492 x 0.787 [12.5 x 20.0] | 1100.0 | 0.20 |
| 3300.0 | 515D338M010DK6AE3 | 0.492 x 0.984 [12.5 x 25.0] | 1400.0 | 0.20 |
| 4700.0 | 515D478M010EK6AE3 | 0.630 x 0.984 [16.0 x 25.0] | 1800.0 | 0.20 |
| 6800.0 | 515D688M010EN6AE3 | 0.630 x 1.240 [16.0 x 31.5] | 2150.0 | 0.20 |
| 10 000.0 | 515D109M010FR6AE3 | 0.709 x 1.398 [18.0 x 35.5] | 2500.0 | 0.20 |
| 15 000.0 | 515D159M010FV6AE3 | 0.709 x 1.575 [18.0 x 40.0] | 2720.0 | 0.20 |
| 16 WV_{DC} AT + 85 °C, SURGE = 20 V | | | | |
| 10.0 | 515D106M016JA6AE3 | 0.197 x 0.433 [5.0 x 11.0] | 28.0 | 0.16 |
| 22.0 | 515D226M016JA6AE3 | 0.197 x 0.433 [5.0 x 11.0] | 44.0 | 0.16 |
| 33.0 | 515D336M016JA6AE3 | 0.197 x 0.433 [5.0 x 11.0] | 57.0 | 0.16 |
| 47.0 | 515D476M016JA6AE3 | 0.197 x 0.433 [5.0 x 11.0] | 168.0 | 0.16 |



| ELECTRICAL DATA AND ORDERING INFORMATION | | | | |
|--|--------------------|------------------------------------|---|--|
| CAPACITANCE (μF) | PART NUMBER | NOMINAL CASE SIZE D x L | MAX. RIPPLE AT + 85 °C 120 Hz (mA) | MAX. DF AT + 20 °C 120 Hz |
| 16 WV_{DC} AT + 85 °C, SURGE = 20 V | | | | |
| 100.0 | 515D107M016AA6AE3 | 0.248 x 0.433 [6.3 x 11.0] | 175.0 | 0.16 |
| 220.0 | 515D227M016BB6AE3 | 0.315 x 0.453 [8.0 x 11.5] | 300.0 | 0.16 |
| 330.0 | 515D337M016BB6AE3 | 0.315 x 0.453 [8.0 x 11.5] | 360.0 | 0.16 |
| 470.0 | 515D477M016CC6AE3 | 0.394 x 0.492 [10.0 x 12.5] | 470.0 | 0.16 |
| 1000.0 | 515D108M016CG6AE3 | 0.394 x 0.787 [10.0 x 20.0] | 790.0 | 0.16 |
| 2200.0 | 515D228M016DK6AE3 | 0.492 x 0.984 [12.5 x 25.0] | 1350.0 | 0.16 |
| 3300.0 | 515D338M016EK6AE3 | 0.630 x 0.984 [16.0 x 25.0] | 1700.0 | 0.16 |
| 4700.0 | 515D478M016EN6AE3 | 0.630 x 1.240 [16.0 x 31.5] | 2100.0 | 0.16 |
| 6800.0 | 515D688M016FR6AE3 | 0.709 x 1.398 [18.0 x 35.5] | 2500.0 | 0.16 |
| 10 000.0 | 515D109M016FV6AE3 | 0.709 x 1.575 [18.0 x 40.0] | 2640.0 | 0.16 |
| 25 WV_{DC} AT + 85 °C, SURGE = 32 V | | | | |
| 4.7 | 515D475M025JA6AE3 | 0.197 x 0.433 [5.0 x 11.0] | 30.0 | 0.14 |
| 10.0 | 515D106M025JA6AE3 | 0.197 x 0.433 [5.0 x 11.0] | 33.0 | 0.14 |
| 22.0 | 515D226M025JA6AE3 | 0.197 x 0.433 [5.0 x 11.0] | 51.0 | 0.14 |
| 33.0 | 515D336M025JA6AE3 | 0.197 x 0.433 [5.0 x 11.0] | 63.0 | 0.14 |
| 47.0 | 515D476M025JA6AE3 | 0.197 x 0.433 [5.0 x 11.0] | 115.0 | 0.14 |
| 100.0 | 515D107M025AA6AE3 | 0.248 x 0.433 [6.3 x 11.0] | 185.0 | 0.14 |
| 220.0 | 515D227M025BB6AE3 | 0.315 x 0.453 [8.0 x 11.5] | 320.0 | 0.14 |
| 330.0 | 515D337M025CC6AE3 | 0.394 x 0.492 [10.0 x 12.5] | 420.0 | 0.14 |
| 470.0 | 515D477M025CD6AE3 | 0.394 x 0.630 [10.0 x 16.0] | 540.0 | 0.14 |
| 1000.0 | 515D108M025DG6AE3 | 0.492 x 0.787 [12.5 x 20.0] | 950.0 | 0.14 |
| 2200.0 | 515D228M025EK6AE3 | 0.630 x 0.984 [16.0 x 25.0] | 1550.0 | 0.14 |
| 3300.0 | 515D338M025EN6AE3 | 0.630 x 1.240 [16.0 x 31.5] | 1950.0 | 0.14 |
| 4700.0 | 515D478M025FR6AE3 | 0.709 x 1.398 [18.0 x 35.5] | 2360.0 | 0.14 |
| 35 WV_{DC} AT + 85 °C, SURGE = 44 V | | | | |
| 4.7 | 515D475M035JA6AE3 | 0.197 x 0.433 [5.0 x 11.0] | 24.0 | 0.12 |
| 10.0 | 515D106M035JA6AE3 | 0.197 x 0.433 [5.0 x 11.0] | 36.0 | 0.12 |
| 22.0 | 515D226M035JA6AE3 | 0.197 x 0.433 [5.0 x 11.0] | 57.0 | 0.12 |
| 33.0 | 515D336M035JA6AE3 | 0.197 x 0.433 [5.0 x 11.0] | 105.0 | 0.12 |
| 47.0 | 515D476M035AA6AE3 | 0.248 x 0.433 [6.3 x 11.0] | 140.0 | 0.12 |
| 100.0 | 515D107M035BB6AE3 | 0.315 x 0.453 [8.0 x 11.5] | 230.0 | 0.12 |
| 220.0 | 515D227M035CC6AE3 | 0.394 x 0.492 [10.0 x 12.5] | 370.0 | 0.12 |
| 330.0 | 515D337M035CD6AE3 | 0.394 x 0.630 [10.0 x 16.0] | 490.0 | 0.12 |
| 470.0 | 515D477M035CG6AE3 | 0.394 x 0.787 [10.0 x 20.0] | 640.0 | 0.12 |
| 1000.0 | 515D108M035DK6AE3 | 0.492 x 0.984 [12.5 x 25.0] | 1100.0 | 0.12 |
| 2200.0 | 515D228M035EN6AE3 | 0.630 x 1.240 [16.0 x 31.5] | 1850.0 | 0.12 |
| 3300.0 | 515D338M035FR6AE3 | 0.709 x 1.382 [18.0 x 35.5] | 2220.0 | 0.12 |
| 4700.0 | 515D478M035FV6AE3 | 0.709 x 1.575 [18.0 x 40.0] | 2490.0 | 0.12 |
| 50 WV_{DC} AT + 85 °C, SURGE = 63 V | | | | |
| 0.10 | 515D104M050JA6AE3 | 0.197 x 0.433 [5.0 x 11.0] | 1.0 | 0.10 |
| 0.22 | 515D224M050JA6AE3 | 0.197 x 0.433 [5.0 x 11.0] | 2.3 | 0.10 |
| 0.33 | 515D334M050JA6AE3 | 0.197 x 0.433 [5.0 x 11.0] | 3.5 | 0.10 |
| 0.47 | 515D474M050JA6AE3 | 0.197 x 0.433 [5.0 x 11.0] | 5.0 | 0.10 |
| 1.0 | 515D105M050JA6AE3 | 0.197 x 0.433 [5.0 x 11.0] | 10.0 | 0.10 |
| 2.2 | 515D225M050JA6AE3 | 0.197 x 0.433 [5.0 x 11.0] | 19.0 | 0.10 |
| 3.3 | 515D335M050JA6AE3 | 0.197 x 0.433 [5.0 x 11.0] | 24.0 | 0.10 |
| 4.7 | 515D475M050JA6AE3 | 0.197 x 0.433 [5.0 x 11.0] | 29.0 | 0.10 |



| ELECTRICAL DATA AND ORDERING INFORMATION | | | | |
|--|--------------------|------------------------------------|---|--|
| CAPACITANCE (μF) | PART NUMBER | NOMINAL CASE SIZE D x L | MAX. RIPPLE AT + 85 °C 120 Hz (mA) | MAX. DF AT + 20 °C 120 Hz |
| 50 WV_{DC} AT + 85 °C, SURGE = 63 V | | | | |
| 10.0 | 515D106M050JA6AE3 | 0.197 x 0.433 [5.0 x 11.0] | 44.0 | 0.10 |
| 22.0 | 515D226M050JA6AE3 | 0.197 x 0.433 [5.0 x 11.0] | 95.0 | 0.10 |
| 33.0 | 515D336M050AA6AE3 | 0.248 x 0.433 [6.3 x 11.0] | 125.0 | 0.10 |
| 47.0 | 515D476M050AA6AE3 | 0.248 x 0.433 [6.3 x 11.0] | 150.0 | 0.10 |
| 100.0 | 515D107M050BB6AE3 | 0.315 x 0.453 [8.0 x 11.5] | 250.0 | 0.10 |
| 220.0 | 515D227M050CD6AE3 | 0.394 x 0.630 [10.0 x 16.0] | 440.0 | 0.10 |
| 330.0 | 515D337M050CG6AE3 | 0.394 x 0.787 [10.0 x 20.0] | 580.0 | 0.10 |
| 470.0 | 515D477M050DG6AE3 | 0.492 x 0.787 [12.5 x 20.0] | 760.0 | 0.10 |
| 1000.0 | 515D108M050EK6AE3 | 0.630 x 0.984 [16.0 x 25.0] | 1350.0 | 0.10 |
| 2200.0 | 515D228M050FR6AE3 | 0.709 x 1.398 [18.0 x 35.5] | 2090.0 | 0.10 |
| 63 WV_{DC} AT + 85 °C, SURGE = 79 V | | | | |
| 4.7 | 515D475M063JA6AE3 | 0.197 x 0.433 [5.0 x 11.0] | 45.0 | 0.08 |
| 10.0 | 515D106M063JA6AE3 | 0.197 x 0.433 [5.0 x 11.0] | 70.0 | 0.08 |
| 22.0 | 515D226M063AA6AE3 | 0.248 x 0.433 [6.3 x 11.0] | 115.0 | 0.08 |
| 33.0 | 515D336M063AA6AE3 | 0.248 x 0.433 [6.3 x 11.0] | 140.0 | 0.08 |
| 47.0 | 515D476M063BB6AE3 | 0.315 x 0.453 [8.0 x 11.5] | 190.0 | 0.08 |
| 100.0 | 515D107M063CC6AE3 | 0.394 x 0.492 [10.0 x 12.5] | 300.0 | 0.08 |
| 220.0 | 515D227M063CG6AE3 | 0.394 x 0.787 [10.0 x 20.0] | 490.0 | 0.08 |
| 330.0 | 515D337M063DG6AE3 | 0.492 x 0.787 [12.5 x 20.0] | 680.0 | 0.08 |
| 470.0 | 515D477M063DK6AE3 | 0.492 x 0.984 [12.5 x 25.0] | 880.0 | 0.08 |
| 1000.0 | 515D108M063EN6AE3 | 0.630 x 1.240 [16.0 x 31.5] | 1550.0 | 0.08 |
| 2200.0 | 515D228M063FV6AE3 | 0.709 x 1.575 [18.0 x 40.0] | 2200.0 | 0.08 |
| 100 WV_{DC} AT + 85 °C, SURGE = 125 V | | | | |
| 0.10 | 515D104M100JA6AE3 | 0.197 x 0.433 [5.0 x 11.0] | 2.1 | 0.08 |
| 0.22 | 515D224M100JA6AE3 | 0.197 x 0.433 [5.0 x 11.0] | 4.7 | 0.08 |
| 0.33 | 515D334M100JA6AE3 | 0.197 x 0.433 [5.0 x 11.0] | 7.0 | 0.08 |
| 0.47 | 515D474M100JA6AE3 | 0.197 x .0433 [5.0 x 11.0] | 10.0 | 0.08 |
| 1.0 | 515D105M100JA6AE3 | 0.197 x 0.433 [5.0 x 11.0] | 21.0 | 0.08 |
| 2.2 | 515D225M100JA6AE3 | 0.197 x 0.433 [5.0 x 11.0] | 30.0 | 0.08 |
| 3.3 | 515D335M100JA6AE3 | 0.197 x 0.433 [5.0 x 11.0] | 40.0 | 0.08 |
| 4.7 | 515D475M100JA6AE3 | 0.197 x 0.433 [5.0 x 11.0] | 45.0 | 0.08 |
| 10.0 | 515D106M100AA6AE3 | 0.248 x 0.433 [6.3 x 11.0] | 75.0 | 0.08 |
| 22.0 | 515D226M100BB6AE3 | 0.315 x 0.453 [8.0 x 11.5] | 130.0 | 0.08 |
| 33.0 | 515D336M100CC6AE3 | 0.394 x 0.492 [10.0 x 12.5] | 170.0 | 0.08 |
| 47.0 | 515D476M100CD6AE3 | 0.394 x 0.630 [10.0 x 16.0] | 230.0 | 0.08 |
| 100.0 | 515D107M100DG6AE3 | 0.492 x 0.787 [12.5 x 20.0] | 400.0 | 0.08 |
| 220.0 | 515D227M100EK6AE3 | 0.630 x 0.984 [16.0 x 25.0] | 710.0 | 0.08 |
| 330.0 | 515D337M100EK6AE3 | 0.630 x 0.984 [16.0 x 25.0] | 860.0 | 0.08 |
| 470.0 | 515D477M100EN6AE3 | 0.630 x 1.240 [16.0 x 31.5] | 1100.0 | 0.08 |
| 1000.0 | 515D108M100FV6AE3 | 0.709 x 1.575 [18.0 x 40.0] | 1690.0 | 0.08 |
| 160 WV_{DC} AT + 85 °C, SURGE = 200 V | | | | |
| 0.47 | 515D474M160AA6AE3 | 0.248 x 0.433 [6.3 x 11.0] | 12.0 | 0.20 |
| 1.0 | 515D105M160AA6AE3 | 0.248 x 0.433 [6.3 x 11.0] | 17.0 | 0.20 |
| 2.2 | 515D225M160AA6AE3 | 0.248 x 0.433 [6.3 x 11.0] | 26.0 | 0.20 |
| 3.3 | 515D335M160BB6AE3 | 0.315 x 0.453 [8.0 x 11.5] | 35.0 | 0.20 |
| 4.7 | 515D475M160BB6AE3 | 0.315 x 0.453 [8.0 x 11.5] | 40.0 | 0.20 |
| 10.0 | 515D106M160CC6AE3 | 0.394 x 0.492 [10.0 x 12.5] | 65.0 | 0.20 |
| 22.0 | 515D226M160CG6AE3 | 0.394 x 0.787 [10.0 x 20.0] | 110.0 | 0.20 |
| 33.0 | 515D336M160DG6AE3 | 0.492 x 0.787 [12.5 x 20.0] | 150.0 | 0.20 |
| 47.0 | 515D476M160DK6AE3 | 0.492 x 0.984 [12.5 x 25.0] | 180.0 | 0.20 |
| 100.0 | 515D107M160EK6AE3 | 0.630 x 0.984 [16.0 x 25.0] | 300.0 | 0.20 |
| 220.0 | 515D227M160FR6AE3 | 0.709 x 1.398 [18.0 x 35.5] | 510.0 | 0.20 |



| ELECTRICAL DATA AND ORDERING INFORMATION | | | | |
|--|--------------------|------------------------------------|---|--|
| CAPACITANCE (μF) | PART NUMBER | NOMINAL CASE SIZE D x L | MAX. RIPPLE AT + 85 °C 120 Hz (mA) | MAX. DF AT + 20 °C 120 Hz |
| 200 WV_{DC} AT + 85 °C, SURGE = 250 V | | | | |
| 0.47 | 515D474M200AA6AE3 | 0.248 x 0.433 [6.3 x 11.0] | 12.0 | 0.20 |
| 1.0 | 515D105M200AA6AE3 | 0.248 x 0.433 [6.3 x 11.0] | 17.0 | 0.20 |
| 2.2 | 515D225M200AA6AE3 | 0.248 x 0.433 [6.3 x 11.0] | 26.0 | 0.20 |
| 3.3 | 515D335M200BB6AE3 | 0.315 x 0.453 [8.0 x 11.5] | 35.0 | 0.20 |
| 4.7 | 515D475M200CC6AE3 | 0.394 x 0.492 [10.0 x 12.5] | 45.0 | 0.20 |
| 10.0 | 515D106M200CD6AE3 | 0.394 x 0.630 [10.0 x 16.0] | 70.0 | 0.20 |
| 22.0 | 515D226M200CG6AE3 | 0.394 x 0.787 [10.0 x 20.0] | 110.0 | 0.20 |
| 33.0 | 515D336M200DK6AE3 | 0.492 x 0.984 [12.5 x 25.0] | 160.0 | 0.20 |
| 47.0 | 515D476M200DK6AE3 | 0.492 x 0.984 [12.5 x 25.0] | 180.0 | 0.20 |
| 100.0 | 515D107M200EN6AE3 | 0.630 x 1.240 [16.0 x 31.5] | 330.0 | 0.20 |
| 220.0 | 515D227M200FV6AE3 | 0.709 x 1.575 [18.0 x 40.0] | 520.0 | 0.20 |
| 250 WV_{DC} AT + 85 °C, SURGE = 300 V | | | | |
| 0.47 | 515D474M250AA6AE3 | 0.248 x 0.433 [6.3 x 11.0] | 12.0 | 0.20 |
| 1.0 | 515D105M250AA6AE3 | 0.248 x 0.433 [6.3 x 11.0] | 17.0 | 0.20 |
| 2.2 | 515D225M250BB6AE3 | 0.315 x 0.453 [8.0 x 11.5] | 30.0 | 0.20 |
| 3.3 | 515D335M250CC6AE3 | 0.394 x 0.492 [10.0 x 12.5] | 35.0 | 0.20 |
| 4.7 | 515D475M250CC6AE3 | 0.394 x 0.492 [10.0 x 12.5] | 45.0 | 0.20 |
| 10.0 | 515D106M250CG6AE3 | 0.394 x 0.787 [10.0 x 20.0] | 70.0 | 0.20 |
| 33.0 | 515D336M250DK6AE3 | 0.492 x 0.984 [12.5 x 25.0] | 160.0 | 0.20 |
| 47.0 | 515D476M250EK6AE3 | 0.630 x 1.240 [16.0 x 31.5] | 210.0 | 0.20 |
| 100.0 | 515D107M250FR6AE3 | 0.709 x 1.575 [18.0 x 40.0] | 340.0 | 0.20 |
| 315 WV_{DC} AT + 85 °C, SURGE = 365 V | | | | |
| 1.0 | 515D105M315AA6AE3 | 0.248 x 0.433 [6.3 x 11.0] | 17.0 | 0.20 |
| 2.2 | 515D225M315BB6AE3 | 0.315 x 0.453 [8.0 x 11.5] | 30.0 | 0.20 |
| 3.3 | 515D335M315CC6AE3 | 0.394 x 0.492 [10.0 x 12.5] | 35.0 | 0.20 |
| 4.7 | 515D475M315CD6AE3 | 0.394 x 0.630 [10.0 x 16.0] | 45.0 | 0.20 |
| 10.0 | 515D106M315CG6AE3 | 0.394 x 0.787 [10.0 x 20.0] | 70.0 | 0.20 |
| 22.0 | 515D226M315DK6AE3 | 0.492 x 0.984 [12.5 x 25.0] | 120.0 | 0.20 |
| 33.0 | 515D336M315EK6AE3 | 0.630 x 0.984 [16.0 x 25.0] | 150.0 | 0.20 |
| 47.0 | 515D476M315EN6AE3 | 0.630 x 1.240 [16.0 x 31.5] | 190.0 | 0.20 |
| 100.0 | 515D107M315FV6AE3 | 0.709 x 1.575 [18.0 x 40.0] | 340.0 | 0.20 |
| 350 WV_{DC} AT + 85 °C, SURGE = 400 V | | | | |
| 1.0 | 515D105M350BB6AE3 | 0.315 x .453 [8.0 x 11.5] | 18.0 | 0.25 |
| 2.2 | 515D225M350CC6AE3 | 0.394 x 0.492 [10.0 x 12.5] | 28.0 | 0.25 |
| 3.3 | 515D335M350CD6AE3 | 0.394 x 0.630 [10.0 x 16.0] | 35.0 | 0.25 |
| 4.7 | 515D475M350CD6AE3 | 0.394 x 0.630 [10.0 x 16.0] | 40.0 | 0.25 |
| 10.0 | 515D106M350DG6AE3 | 0.492 x 0.787 [12.5 x 20.0] | 70.0 | 0.25 |
| 22.0 | 515D226M350DK6AE3 | 0.492 x 0.984 [12.5 x 25.0] | 110.0 | 0.25 |
| 33.0 | 515D336M350EN6AE3 | 0.630 x 1.240 [16.0 x 31.5] | 140.0 | 0.25 |
| 47.0 | 515D476M350FR6AE3 | 0.709 x 1.398 [18.0 x 35.5] | 220.0 | 0.25 |
| 400 WV_{DC} AT + 85 °C, SURGE = 450 V | | | | |
| 1.0 | 515D105M400BB6AE3 | 0.315 x 0.453 [8.0 x 11.5] | 18.0 | 0.25 |
| 2.2 | 515D225M400CC6AE3 | 0.394 x 0.492 [10.0 x 12.5] | 28.0 | 0.25 |
| 3.3 | 515D335M400CD6AE3 | 0.394 x 0.630 [10.0 x 16.0] | 35.0 | 0.25 |
| 4.7 | 515D475M400CD6AE3 | 0.394 x 0.787 [10.0 x 20.0] | 45.0 | 0.25 |
| 10.0 | 515D106M400DG6AE3 | 0.492 x 0.787 [12.5 x 20.0] | 70.0 | 0.25 |
| 22.0 | 515D226M400DK6AE3 | 0.630 x 0.984 [16.0 x 25.0] | 110.0 | 0.25 |
| 33.0 | 515D336M400EN6AE3 | 0.630 x 1.240 [16.0 x 31.5] | 140.0 | 0.25 |
| 47.0 | 515D476M400FR6AE3 | 0.709 x 1.398 [18.0 x 35.5] | 220.0 | 0.25 |



| ELECTRICAL DATA AND ORDERING INFORMATION | | | | |
|--|-------------------|-----------------------------|--|---------------------------------|
| CAPACITANCE (μ F) | PART NUMBER | NOMINAL CASE SIZE D x L | MAX. RIPPLE AT + 85 °C 120 Hz (mA) | MAX. DF AT + 20 °C 120 Hz |
| 450 WV_{DC} AT + 85 °C, SURGE = 500 V | | | | |
| 1.0 | 515D105M450CC6AE3 | 0.394 x 0.492 [10.0 x 12.5] | 19.0 | 0.25 |
| 2.2 | 515D225M450CD6AE3 | 0.394 x 0.630 [10.0 x 16.0] | 29.0 | 0.25 |
| 4.7 | 515D475M450DG6AE3 | 0.492 x 0.787 [12.5 x 20.0] | 50.0 | 0.25 |
| 10.0 | 515D106M450EK6AE3 | 0.492 x 0.984 [12.5 x 25.0] | 75.0 | 0.25 |
| 22.0 | 515D226M450EN6AE3 | 0.630 x 1.240 [16.0 x 31.5] | 110.0 | 0.25 |
| 33.0 | 515D336M450FR6AE3 | 0.709 x 1.398 [18.0 x 35.5] | 170.0 | 0.25 |

| LOW PROFILE RATINGS in inches [millimeters] | | | | |
|--|-------------------|----------------------------|--|---------------------------------|
| CAPACITANCE (μ F) | PART NUMBER | NOMINAL CASE SIZE D x L | MAX. RIPPLE AT + 85 °C 120 Hz (mA) | MAX. DF AT + 20 °C 120 Hz |
| 6.3 WV_{DC} AT + 85 °C, SURGE = 8 V | | | | |
| 22.0 | 515D226M6R3HW6AE3 | 0.157 x 0.276 [4.0 x 7.0] | 34.0 | 0.24 |
| 33.0 | 515D336M6R3JW6AE3 | 0.197 x 0.276 [5.0 x 7.0] | 42.0 | 0.24 |
| 47.0 | 515D476M6R3JW6AE3 | 0.197 x 0.276 [5.0 x 7.0] | 50.0 | 0.24 |
| 100.0 | 515D107M6R3AW6AE3 | 0.248 x 0.276 [6.3 x 7.0] | 77.0 | 0.24 |
| 10 WV_{DC} AT + 85 °C, SURGE = 13 V | | | | |
| 22.0 | 515D226M010JW6AE3 | 0.197 x 0.276 [5.0 x 7.0] | 38.0 | 0.20 |
| 33.0 | 515D336M010JW6AE3 | 0.197 x 0.276 [5.0 x 7.0] | 47.0 | 0.20 |
| 47.0 | 515D476M010AW6AE3 | 0.248 x 0.276 [6.3 x 7.0] | 59.0 | 0.20 |
| 16 WV_{DC} AT + 85 °C, SURGE = 20 V | | | | |
| 10.0 | 515D106M016HW6AE3 | 0.157 x 0.276 [4.0 x 7.0] | 28.0 | 0.16 |
| 22.0 | 515D226M016JW6AE3 | 0.197 x 0.276 [5.0 x 7.0] | 44.0 | 0.16 |
| 33.0 | 515D336M016AW6AE3 | 0.248 x 0.276 [6.3 x 7.0] | 57.0 | 0.16 |
| 47.0 | 515D476M016AW6AE3 | 0.248 x 0.276 [6.3 x 7.0] | 68.0 | 0.16 |
| 25 WV_{DC} AT + 85 °C, SURGE = 32 V | | | | |
| 10.0 | 515D106M025JW6AE3 | 0.197 x 0.276 [5.0 x 7.0] | 33.0 | 0.14 |
| 22.0 | 515D226M025AW6AE3 | 0.248 x 0.276 [6.3 x 7.0] | 51.0 | 0.14 |
| 33.0 | 515D336M025AW6AE3 | 0.248 x 0.276 [6.3 x 7.0] | 63.0 | 0.14 |
| 35 WV_{DC} AT + 85 °C, SURGE = 44 V | | | | |
| 4.7 | 515D475M035HW6AE3 | 0.157 x 0.276 [4.0 x 7.0] | 24.0 | 0.12 |
| 10.0 | 515D106M035JW6AE3 | 0.197 x 0.276 [5.0 x 7.0] | 36.0 | 0.12 |
| 22.0 | 515D226M035AW6AE3 | 0.248 x 0.276 [6.3 x 7.0] | 57.0 | 0.12 |
| 50 WV_{DC} AT + 85 °C, SURGE = 63 V | | | | |
| 0.10 | 515D104M050JW6AE3 | 0.157 x 0.276 [4.0 x 7.0] | 1.0 | 0.10 |
| 0.22 | 515D224M050HW6AE3 | 0.157 x 0.276 [4.0 x 7.0] | 2.3 | 0.10 |
| 0.33 | 515D334M050HW6AE3 | 0.157 x 0.276 [4.0 x 7.0] | 3.5 | 0.10 |
| 0.47 | 515D474M050HW6AE3 | 0.157 x 0.276 [4.0 x 7.0] | 5.0 | 0.10 |
| 1.0 | 515D105M050HW6AE3 | 0.157 x 0.276 [4.0 x 7.0] | 10.0 | 0.10 |
| 2.2 | 515D225M050HW6AE3 | 0.157 x 0.276 [4.0 x 7.0] | 19.0 | 0.10 |
| 3.3 | 515D335M050HW6AE3 | 0.157 x 0.276 [4.0 x 7.0] | 24.0 | 0.10 |
| 4.7 | 515D475M050JW6AE3 | 0.197 x 0.276 [5.0 x 7.0] | 29.0 | 0.10 |
| 10.0 | 515D106M050AW6AE3 | 0.248 x 0.276 [6.3 x 7.0] | 44.0 | 0.10 |



Disclaimer

ALL PRODUCT, PRODUCT SPECIFICATIONS AND DATA ARE SUBJECT TO CHANGE WITHOUT NOTICE TO IMPROVE RELIABILITY, FUNCTION OR DESIGN OR OTHERWISE.

Vishay Intertechnology, Inc., its affiliates, agents, and employees, and all persons acting on its or their behalf (collectively, "Vishay"), disclaim any and all liability for any errors, inaccuracies or incompleteness contained in any datasheet or in any other disclosure relating to any product.

Vishay makes no warranty, representation or guarantee regarding the suitability of the products for any particular purpose or the continuing production of any product. To the maximum extent permitted by applicable law, Vishay disclaims (i) any and all liability arising out of the application or use of any product, (ii) any and all liability, including without limitation special, consequential or incidental damages, and (iii) any and all implied warranties, including warranties of fitness for particular purpose, non-infringement and merchantability.

Statements regarding the suitability of products for certain types of applications are based on Vishay's knowledge of typical requirements that are often placed on Vishay products in generic applications. Such statements are not binding statements about the suitability of products for a particular application. It is the customer's responsibility to validate that a particular product with the properties described in the product specification is suitable for use in a particular application. Parameters provided in datasheets and/or specifications may vary in different applications and performance may vary over time. All operating parameters, including typical parameters, must be validated for each customer application by the customer's technical experts. Product specifications do not expand or otherwise modify Vishay's terms and conditions of purchase, including but not limited to the warranty expressed therein.

Except as expressly indicated in writing, Vishay products are not designed for use in medical, life-saving, or life-sustaining applications or for any other application in which the failure of the Vishay product could result in personal injury or death. Customers using or selling Vishay products not expressly indicated for use in such applications do so at their own risk. Please contact authorized Vishay personnel to obtain written terms and conditions regarding products designed for such applications.

No license, express or implied, by estoppel or otherwise, to any intellectual property rights is granted by this document or by any conduct of Vishay. Product names and markings noted herein may be trademarks of their respective owners.

Material Category Policy

Vishay Intertechnology, Inc. hereby certifies that all its products that are identified as RoHS-Compliant fulfill the definitions and restrictions defined under Directive 2011/65/EU of The European Parliament and of the Council of June 8, 2011 on the restriction of the use of certain hazardous substances in electrical and electronic equipment (EEE) - recast, unless otherwise specified as non-compliant.

Please note that some Vishay documentation may still make reference to RoHS Directive 2002/95/EC. We confirm that all the products identified as being compliant to Directive 2002/95/EC conform to Directive 2011/65/EU.

Vishay Intertechnology, Inc. hereby certifies that all its products that are identified as Halogen-Free follow Halogen-Free requirements as per JEDEC JS709A standards. Please note that some Vishay documentation may still make reference to the IEC 61249-2-21 definition. We confirm that all the products identified as being compliant to IEC 61249-2-21 conform to JEDEC JS709A standards.



Компания «ЭлектроПласт» предлагает заключение долгосрочных отношений при поставках импортных электронных компонентов на взаимовыгодных условиях!

Наши преимущества:

- Оперативные поставки широкого спектра электронных компонентов отечественного и импортного производства напрямую от производителей и с крупнейших мировых складов;
- Поставка более 17-ти миллионов наименований электронных компонентов;
- Поставка сложных, дефицитных, либо снятых с производства позиций;
- Оперативные сроки поставки под заказ (от 5 рабочих дней);
- Экспресс доставка в любую точку России;
- Техническая поддержка проекта, помощь в подборе аналогов, поставка прототипов;
- Система менеджмента качества сертифицирована по Международному стандарту ISO 9001;
- Лицензия ФСБ на осуществление работ с использованием сведений, составляющих государственную тайну;
- Поставка специализированных компонентов (Xilinx, Altera, Analog Devices, Intersil, Interpoint, Microsemi, Aeroflex, Peregrine, Syfer, Eurofarad, Texas Instrument, Miteq, Cobham, E2V, MA-COM, Hittite, Mini-Circuits, General Dynamics и др.);

Помимо этого, одним из направлений компании «ЭлектроПласт» является направление «Источники питания». Мы предлагаем Вам помощь Конструкторского отдела:

- Подбор оптимального решения, техническое обоснование при выборе компонента;
- Подбор аналогов;
- Консультации по применению компонента;
- Поставка образцов и прототипов;
- Техническая поддержка проекта;
- Защита от снятия компонента с производства.



Как с нами связаться

Телефон: 8 (812) 309 58 32 (многоканальный)

Факс: 8 (812) 320-02-42

Электронная почта: org@eplast1.ru

Адрес: 198099, г. Санкт-Петербург, ул. Калинина, дом 2, корпус 4, литера А.