

GV2P10

TeSys GV2 Manual Starter and Protector, thermal magnetic circuit protector, rotary handle, 4...6.3 A, screw clamp terminals



Main

Range	TeSys
Product name	TeSys GV2
Device short name	GV2P
Product or component type	Circuit breaker
Device application	Motor
Trip unit technology	Thermal-magnetic

Complementary

Poles description	3P
Network type	AC
Utilisation category	AC-3 conforming to IEC 60947-4-1 Category A conforming to IEC 60947-2
Network frequency	50/60 Hz conforming to IEC 60947-4-1
Fixing mode	Clipped on 35 mm symmetrical DIN rail Screwed on panel (with 2 x M4 screws)
Operating position	Any position
Motor power kW	3 kW at 500 V AC 50/60 Hz 4 kW at 690 V AC 50/60 Hz 2.2 kW at 400/415 V AC 50/60 Hz
Breaking capacity	100 kA Icu at 500 V AC 50/60 Hz conforming to IEC 60947-2 100 kA Icu at 230/240 V AC 50/60 Hz conforming to IEC 60947-2 100 kA Icu at 400/415 V AC 50/60 Hz conforming to IEC 60947-2 100 kA Icu at 440 V AC 50/60 Hz conforming to IEC 60947-2 6 kA Icu at 690 V AC 50/60 Hz conforming to IEC 60947-2
[Ics] rated service short-circuit breaking capacity	100 % at 230/240 V AC 50/60 Hz conforming to IEC 60947-2 100 % at 440 V AC 50/60 Hz conforming to IEC 60947-2 100 % at 500 V AC 50/60 Hz conforming to IEC 60947-2 100 % at 690 V AC 50/60 Hz conforming to IEC 60947-2 100 % at 400/415 V AC 50/60 Hz conforming to IEC 60947-2
Control type	Rotary knob
[In] rated current	6.3 A
Trip unit rating	4...6.3 A
Magnetic tripping current	78 A
System Voltage	690 V AC 50/60 Hz conforming to IEC 60947-2
[U _i] rated insulation voltage	690 V AC 50/60 Hz conforming to IEC 60947-2
[I _{th}] conventional free air thermal current	6.3 A conforming to IEC 60947-4-1
[U _{imp}] rated impulse withstand voltage	6 kV conforming to IEC 60947-2
Power dissipation per pole	2.5 W
Mechanical durability	100000 cycles
Electrical durability	100000 cycles AC-3 at 440 V
Operating rate	25 cyc/h
Rated duty	Continuous conforming to IEC 60947-4-1
Connections - terminals	Screw clamp terminals 2 cable(s) 1...6 mm ² solid Screw clamp terminals 2 cable(s) 1.5...6 mm ² flexible without cable end Screw clamp terminals 2 cable(s) 1...4 mm ² flexible with cable end
Tightening torque	1.7 N.m on screw clamp terminals

The information provided in this documentation contains general descriptions and/or technical characteristics of the products contained herein. This documentation is not intended as a substitute for and is not to be used for determining suitability or reliability of these products for specific user applications. It is the duty of any such user or integrator to perform the appropriate and complete risk analysis, evaluation and testing of the products with respect to the relevant specific application or use thereof. Neither Schneider Electric Industries SAS nor any of its affiliates or subsidiaries shall be responsible or liable for misuse of the information contained herein.

Suitability for isolation	Yes conforming to IEC 60947-1
Phase failure sensitivity	Yes conforming to IEC 60947-4-1
Height	3.5 in (89 mm)
Width	1.77 in (45 mm)
Depth	3.82 in (97 mm)

Environment

standards	EN 60204 IEC 60947-1 IEC 60947-2 IEC 60947-4-1 NF C 63-120 NF C 63-650 NF C 79-130 UL 508 VDE 0113 VDE 0660 CSA C22.2
product certifications	ATEX BV CCC CSA DNV EZU GL LROS (Lloyds register of shipping) RINA TSE UL UL 508 type E EAC
protective treatment	TH
IP degree of protection	IP20 conforming to IEC 60529
IK degree of protection	IK04
ambient air temperature for operation	-4...140 °F (-20...60 °C)
ambient air temperature for storage	-40...176 °F (-40...80 °C)
fire resistance	1760 °F (960 °C) conforming to IEC 60695-2-1
operating altitude	6561.68 ft (2000 m)

Offer Sustainability

Green Premium product	Green Premium product
Compliant - since 0631 - Schneider Electric declaration of conformity	Compliant - since 0631 - Schneider Electric declaration of conformity
Reference contains SVHC above the threshold - go to CaP for more details	Reference contains SVHC above the threshold
Available	Available
Need no specific recycling operations	Need no specific recycling operations
WARNING: This product can expose you to chemicals including:	WARNING: This product can expose you to chemicals including:
Antimony oxide & Antimony trioxide, which is known to the State of California to cause cancer.	Antimony oxide & Antimony trioxide, which is known to the State of California to cause cancer.
For more information go to www.p65warnings.ca.gov	For more information go to www.p65warnings.ca.gov

Contractual warranty

Warranty period	18 months
-----------------	-----------

Thermal-Magnetic Tripping Curves for GV2ME and GV2P

Average Operating Times at 20 °C Related to Multiples of the Setting Current



- 1 3 poles from cold state
- 2 2 poles from cold state
- 3 3 poles from hot state

Current Limitation on Short-Circuit for GV2ME and GV2P (3-Phase 400/415 V)

Dynamic Stress

$I_{peak} = f(\text{prospective } I_{sc}) \text{ at } 1.05 U_e = 435 \text{ V}$



- 1 Maximum peak current
- 2 24-32 A
- 3 20-25 A
- 4 17-23 A
- 5 13-18 A
- 6 9-14 A
- 7 6-10 A
- 8 4-6.3 A
- 9 2.5-4 A
- 10 1.6-2.5 A
- 11 1-1.6 A
- 12 Limit of rated ultimate breaking capacity on short-circuit of GV2ME (14, 18, 23, and 25 A ratings).

Thermal Limit on Short-Circuit for GV2P

Thermal Limit in kA²s in the Magnetic Operating Zone

Sum of $I^2dt = f$ (prospective I_{sc}) at $1.05 U_e = 435 V$

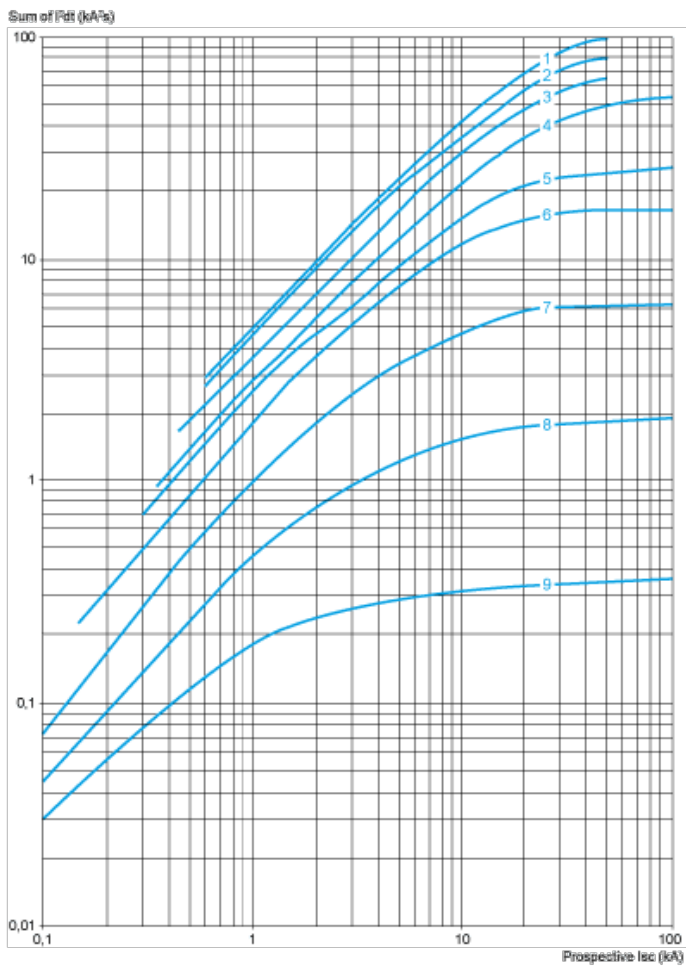

- 1 24-32 A
- 2 20-25 A
- 3 17-23 A
- 4 13-18 A
- 5 9-14 A
- 6 6-10 A
- 7 4-6.3 A
- 8 2.5-4 A
- 9 1.6-2.5 A
- 10 1-1.6 A

GV2P

On rail AM1 DE200, ED200 (35 x 15)

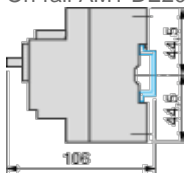

Panel mounted

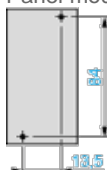

On pre-slotted plate AM1 PA

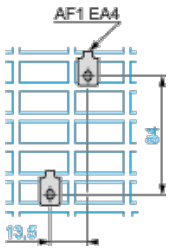

Adapter plate GK2AF01

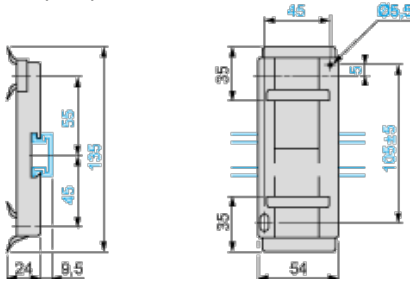

Combination GV2P + TeSys d contactor

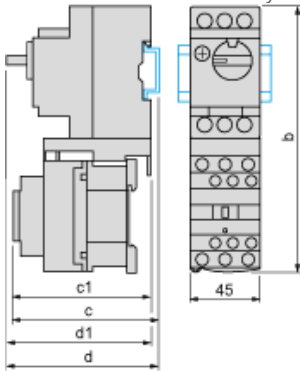

GV2P +	LC1D09...D18	LC1D25 and D32
b	176.4	186.8
c1	100.1	106.4
c	105.6	111.9
d1	95	95
d	100.5	100.5

Mounting

Mounting of External Operator GV2APN01, GV2APN02 or GV2APN04 for Motor Circuit Breakers GV2P

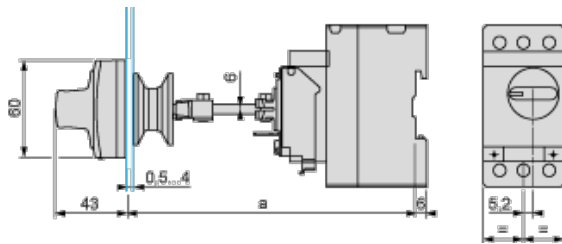

Door cut-out

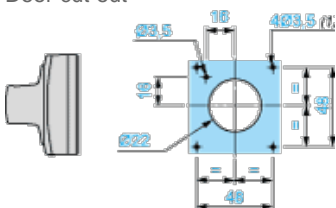

(1) For IP65 only.

Mounting of External Operator GVAPH02 for Motor Circuit Breakers GV2P

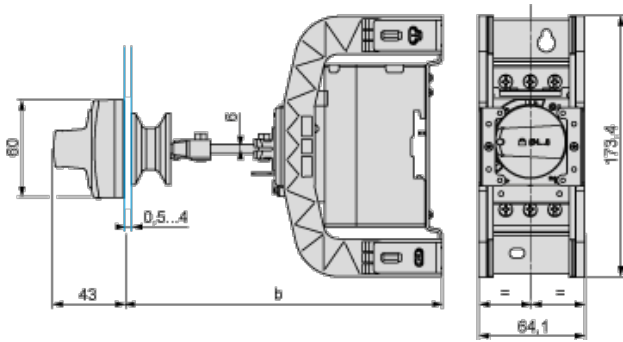

	a		b	
	Minimum	Maximum	Minimum	Maximum
GV2APN..	140	250	–	–
GV2APN.. + GVAPH02	–	–	151	250
GV2APN.. + GVAPK11	250	434	–	–
GV2APN.. + GVAPH02 + GVAPK11	–	–	250	445

Door cut-out

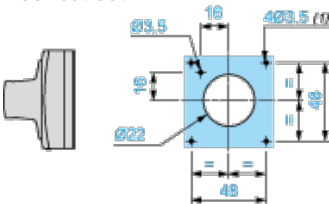

(1) For IP65 only.

GV2P..

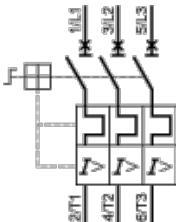



Компания «ЭлектроПласт» предлагает заключение долгосрочных отношений при поставках импортных электронных компонентов на взаимовыгодных условиях!

Наши преимущества:

- Оперативные поставки широкого спектра электронных компонентов отечественного и импортного производства напрямую от производителей и с крупнейших мировых складов;
- Поставка более 17-ти миллионов наименований электронных компонентов;
- Поставка сложных, дефицитных, либо снятых с производства позиций;
- Оперативные сроки поставки под заказ (от 5 рабочих дней);
- Экспресс доставка в любую точку России;
- Техническая поддержка проекта, помощь в подборе аналогов, поставка прототипов;
- Система менеджмента качества сертифицирована по Международному стандарту ISO 9001;
- Лицензия ФСБ на осуществление работ с использованием сведений, составляющих государственную тайну;
- Поставка специализированных компонентов (Xilinx, Altera, Analog Devices, Intersil, Interpoint, Microsemi, Aeroflex, Peregrine, Syfer, Eurofarad, Texas Instrument, Miteq, Cobham, E2V, MA-COM, Hittite, Mini-Circuits, General Dynamics и др.);

Помимо этого, одним из направлений компании «ЭлектроПласт» является направление «Источники питания». Мы предлагаем Вам помощь Конструкторского отдела:

- Подбор оптимального решения, техническое обоснование при выборе компонента;
- Подбор аналогов;
- Консультации по применению компонента;
- Поставка образцов и прототипов;
- Техническая поддержка проекта;
- Защита от снятия компонента с производства.



Как с нами связаться

Телефон: 8 (812) 309 58 32 (многоканальный)

Факс: 8 (812) 320-02-42

Электронная почта: org@eplast1.ru

Адрес: 198099, г. Санкт-Петербург, ул. Калинина, дом 2, корпус 4, литера А.