

# Low Noise, Picoampere Bias Current, JFET Input Op Amp

## FEATURES

- **Input Bias Current, Warmed Up: 10pA Max**
- **100% Tested Low Voltage Noise:  $8\text{nV}/\sqrt{\text{Hz}}$  Max**
- **A Grade 100% Temperature Tested**
- Offset Voltage Over Temp: 1mV Max
- Input Resistance:  $10^{13}\Omega$
- Very Low Input Capacitance: 1.5pF
- Voltage Gain: 1 Million Min
- Gain-Bandwidth Product: 4.2MHz Typ
- Guaranteed Specifications with  $\pm 5\text{V}$  Supplies

## APPLICATIONS

- Photocurrent Amplifiers
- Hydrophone Amplifiers
- High Sensitivity Piezoelectric Accelerometers
- Low Voltage and Current Noise Instrumentation Amplifier Front Ends
- Two and Three Op Amp Instrumentation Amplifiers
- Active Filters

LT, LTC and LT are registered trademarks of Linear Technology Corporation.

## DESCRIPTION

The LT<sup>®</sup>1793 achieves a new standard of excellence in noise performance for a JFET op amp. For the first time low voltage noise ( $6\text{nV}/\sqrt{\text{Hz}}$ ) is simultaneously offered with extremely low current noise ( $0.8\text{fA}/\sqrt{\text{Hz}}$ ), providing the lowest total noise for high impedance transducer applications. Unlike most JFET op amps, the very low input bias current (3pA typ) is maintained over the entire common mode range which results in an extremely high input resistance ( $10^{13}\Omega$ ). When combined with a very low input capacitance (1.5pF) an extremely high input impedance results, making the LT1793 the first choice for amplifying low level signals from high impedance transducers. The low input capacitance also assures high gain linearity when buffering AC signals from high impedance transducers.

The LT1793 is unconditionally stable for gains of 1 or more, even with 1000pF capacitive loads. Other key features are  $250\mu\text{V}$   $V_{OS}$  and a voltage gain over 4 million. Each individual amplifier is 100% tested for voltage noise, slew rate ( $3.4\text{V}/\mu\text{s}$ ) and gain-bandwidth product (4.2MHz).

Specifications at  $\pm 5\text{V}$  supply operation are also provided. For an even lower voltage noise please see the LT1792 data sheet.

## TYPICAL APPLICATION

Low Noise Light Sensor with DC Servo



1kHz Output Voltage Noise Density vs Source Resistance

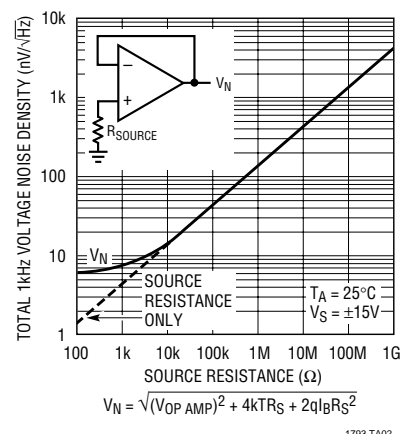

## ABSOLUTE MAXIMUM RATINGS (Note 1)

Supply Voltage .....	±20V	Specified Temperature Range	
Differential Input Voltage .....	±40V	Commercial (Note 8) .....	–40°C to 85°C
Input Voltage (Equal to Supply Voltage) .....	±20V	Industrial .....	–40°C to 85°C
Output Short-Circuit Duration .....	Indefinite	Storage Temperature Range .....	–65°C to 150°C
Operating Temperature Range .....	–40°C to 85°C	Lead Temperature (Soldering, 10 sec) .....	300°C

## PACKAGE/ORDER INFORMATION

<p>N8 PACKAGE 8-LEAD PDIP <math>T_{JMAX} = 150^{\circ}\text{C}, \theta_{JA} = 80^{\circ}\text{C/W}</math></p>	ORDER PART NUMBER	<p>S8 PACKAGE 8-LEAD PLASTIC SO <math>T_{JMAX} = 160^{\circ}\text{C}, \theta_{JA} = 190^{\circ}\text{C/W}</math></p>	ORDER PART NUMBER
	LT1793ACN8 LT1793CN8 LT1793AIN8 LT1793IN8		LT1793ACS8 LT1793CS8 LT1793AIS8 LT1793IS8
		S8 PART MARKING	
		1793A 1793AI	1793 1793I

Consult factory for Military grade parts.

## ELECTRICAL CHARACTERISTICS $T_A = 25^{\circ}\text{C}, V_S = \pm 15\text{V}, V_{CM} = 0\text{V}$ , unless otherwise noted.

SYMBOL	PARAMETER	CONDITIONS (Note 2)	LT1793AC/LT1793AI			LT1793C/LT1793I			UNITS
			MIN	TYP	MAX	MIN	TYP	MAX	
$V_{OS}$	Input Offset Voltage	$V_S = \pm 5\text{V}$		0.25	0.8		0.25	0.9	mV
				0.45	1.4		0.45	1.6	mV
$I_{OS}$	Input Offset Current	Warmed Up (Note 3) $T_J = 25^{\circ}\text{C}$ (Note 6)		1.5	7		2.5	15	µA
				0.5	2		0.7	4	µA
$I_B$	Input Bias Current	Warmed Up (Note 3) $T_J = 25^{\circ}\text{C}$ (Note 6)		3	10		4.0	20	µA
				1	3		1.5	5	µA
$e_n$	Input Noise Voltage	0.1Hz to 10Hz		2.4			2.4		µV <sub>P-P</sub>
	Input Noise Voltage Density	$f_0 = 10\text{Hz}$ $f_0 = 1000\text{Hz}$		11.5			11.5		nV/ $\sqrt{\text{Hz}}$
				6	8		6	8	nV/ $\sqrt{\text{Hz}}$
$i_n$	Input Noise Current Density	$f_0 = 10\text{Hz}, f_0 = 1\text{kHz}$ (Note 4)		0.8			1		fA/ $\sqrt{\text{Hz}}$
$R_{IN}$	Input Resistance			$10^{14}$			$10^{14}$		Ω
	Differential Mode			$10^{13}$			$10^{13}$		Ω
	Common Mode	$V_{CM} = -10\text{V to } 13\text{V}$							
$C_{IN}$	Input Capacitance	$V_S = \pm 5\text{V}$		1.5			1.5		pF
				2.0			2.0		pF
$V_{CM}$	Input Voltage Range (Note 5)		13.0	13.5		13.0	13.5		V
			–10.5	–11.0		–10.5	–11.0		V
CMRR	Common Mode Rejection Ratio	$V_{CM} = -10\text{V to } 13\text{V}$	83	102		81	96		dB
PSRR	Power Supply Rejection Ratio	$V_S = \pm 4.5\text{V to } \pm 20\text{V}$	85	98		83	95		dB

**ELECTRICAL CHARACTERISTICS**  $T_A = 25^\circ\text{C}$ ,  $V_S = \pm 15\text{V}$ ,  $V_{CM} = 0\text{V}$ , unless otherwise noted.

SYMBOL	PARAMETER	CONDITIONS (Note 2)	LT1793AC/LT1793AI			LT1793C/LT1793I			UNITS	
			MIN	TYP	MAX	MIN	TYP	MAX		
$A_{VOL}$	Large-Signal Voltage Gain	$V_O = \pm 12\text{V}$ , $R_L = 10\text{k}$ $V_O = \pm 10\text{V}$ , $R_L = 1\text{k}$	1000	4500		900	4400		V/mV	
			500	3500		400	3000		V/mV	
$V_{OUT}$	Output Voltage Swing	$R_L = 10\text{k}$ $R_L = 1\text{k}$	$\pm 13.0$	$\pm 13.2$		$\pm 13.0$	$\pm 13.2$		V	
			$\pm 12.0$	$\pm 12.3$		$\pm 12.0$	$\pm 12.3$		V	
SR	Slew Rate	$R_L \geq 2\text{k}$ (Note 7)	2.3	3.4		2.3	3.4		V/ $\mu\text{s}$	
GBW	Gain-Bandwidth Product	$f_0 = 100\text{kHz}$	2.5	4.2		2.5	4.2		MHz	
$I_S$	Supply Current	$V_S = \pm 5\text{V}$		4.2	5.20		4.2	5.20		mA
				4.2	5.15		4.2	5.15		mA
	Offset Voltage Adjustment Range	$R_{POT}$ (to $V_{EE}$ ) = 10k		13			13		mV	

The ● denotes specifications which apply over the temperature range  $0^\circ\text{C} \leq T_A \leq 70^\circ\text{C}$ , otherwise specifications are at  $T_A = 25^\circ\text{C}$ .  $V_S = \pm 15\text{V}$ ,  $V_{CM} = 0\text{V}$ , unless otherwise noted. (Note 9)

SYMBOL	PARAMETER	CONDITIONS (Note 2)	LT1793AC			LT1793C			UNITS
			MIN	TYP	MAX	MIN	TYP	MAX	
$V_{OS}$	Input Offset Voltage	$V_S = \pm 5\text{V}$		0.50	1.0		1.0	3.5	mV
			●	0.75	1.6		1.6	4.2	mV
$\frac{\Delta V_{OS}}{\Delta \text{Temp}}$	Average Input Offset Voltage Drift	(Note 6)	●	5	13		8	50	$\mu\text{V}/^\circ\text{C}$
$I_{OS}$	Input Offset Current		●	15	100		20	130	pA
$I_B$	Input Bias Current		●	130	400		150	500	pA
$V_{CM}$	Input Voltage Range (Note 5)		●	12.9	13.4		12.9	13.4	V
			●	-10.0	-10.8		-10.0	-10.8	V
CMRR	Common Mode Rejection Ratio	$V_{CM} = -10\text{V}$ to $12.9\text{V}$	●	79	100		77	95	dB
PSRR	Power Supply Rejection Ratio	$V_S = \pm 4.5\text{V}$ to $\pm 20\text{V}$	●	83	97		81	94	dB
$A_{VOL}$	Large-Signal Voltage Gain	$V_O = \pm 12\text{V}$ , $R_L = 10\text{k}$ $V_O = \pm 10\text{V}$ , $R_L = 1\text{k}$	●	900	3600		800	3400	V/mV
			●	500	2600		400	2400	V/mV
$V_{OUT}$	Output Voltage Swing	$R_L = 10\text{k}$ $R_L = 1\text{k}$	●	$\pm 12.9$	$\pm 13.2$		$\pm 12.9$	$\pm 13.2$	V
			●	$\pm 11.9$	$\pm 12.15$		$\pm 11.9$	$\pm 12.15$	V
SR	Slew Rate	$R_L \geq 2\text{k}$ (Note 7)	●	2.2	3.3		2.2	3.3	V/ $\mu\text{s}$
GBW	Gain-Bandwidth Product	$f_0 = 100\text{kHz}$	●	2.2	3.3		2.2	3.3	MHz
$I_S$	Supply Current	$V_S = \pm 5\text{V}$	●	4.2	5.30		4.2	5.30	mA
			●	4.2	5.25		4.2	5.25	mA

**ELECTRICAL CHARACTERISTICS** The ● denotes specifications which apply over the temperature range  $-40^{\circ}\text{C} \leq T_A \leq 85^{\circ}\text{C}$ .  $V_S = \pm 15\text{V}$ ,  $V_{CM} = 0\text{V}$ , unless otherwise noted. (Notes 8, 9)

SYMBOL	PARAMETER	CONDITIONS (Note 2)	LT1793AC/LT1793AI			LT1793C/LT1793I			UNITS
			MIN	TYP	MAX	MIN	TYP	MAX	
$V_{OS}$	Input Offset Voltage	$V_S = \pm 5\text{V}$	●	0.65	1.3		1.6	4.8	mV
			●	1.00	1.9		2.0	5.5	mV
$\frac{\Delta V_{OS}}{\Delta \text{Temp}}$	Average Input Offset Voltage Drift	(Note 6)	●	5	13		9	50	$\mu\text{V}/^{\circ}\text{C}$
$I_{OS}$	Input Offset Current		●	80	300		100	400	$\mu\text{A}$
$I_B$	Input Bias Current		●	700	2400		800	3000	$\mu\text{A}$
$V_{CM}$	Input Voltage Range (Note 5)		●	12.6	13.0		12.6	13.0	V
			●	-10.0	-10.5		-10.0	-10.5	V
CMRR	Common Mode Rejection Ratio	$V_{CM} = -10\text{V}$ to $12.6\text{V}$	●	78	99		76	94	dB
PSRR	Power Supply Rejection Ratio	$V_S = \pm 4.5\text{V}$ to $\pm 20\text{V}$	●	81	96		79	93	dB
$A_{VOL}$	Large-Signal Voltage Gain	$V_O = \pm 12\text{V}$ , $R_L = 10\text{k}$ $V_O = \pm 10\text{V}$ , $R_L = 1\text{k}$	●	850	3300		750	3000	V/mV
			●	400	2200		300	2000	V/mV
$V_{OUT}$	Output Voltage Swing	$R_L = 10\text{k}$ $R_L = 1\text{k}$	●	$\pm 12.8$	$\pm 13.1$		$\pm 12.8$	$\pm 13.1$	V
			●	$\pm 11.8$	$\pm 12.1$		$\pm 11.8$	$\pm 12.1$	V
SR	Slew Rate	$R_L \geq 2\text{k}$	●	2.1	3.2		2.1	3.2	$\text{V}/\mu\text{s}$
GBW	Gain-Bandwidth Product	$f_0 = 100\text{kHz}$	●	2	3.1		2	3.1	MHz
$I_S$	Supply Current	$V_S = \pm 5\text{V}$	●	4.2	5.40		4.2	5.40	mA
			●	4.2	5.35		4.2	5.35	mA

**Note 1:** Absolute Maximum Ratings are those values beyond which the life of a device may be impaired.

**Note 2:** Typical parameters are defined as the 60% yield of parameter distributions of individual amplifiers.

**Note 3:**  $I_B$  and  $I_{OS}$  readings are extrapolated to a warmed-up temperature from  $25^{\circ}\text{C}$  measurements and  $32^{\circ}\text{C}$  characterization data.

**Note 4:** Current noise is calculated from the formula:

$$i_n = (2qI_B)^{1/2}$$

where  $q = 1.6 \cdot 10^{-19}$  coulomb. The noise of source resistors up to 200M swamps the contribution of current noise.

**Note 5:** Input voltage range functionality is assured by testing offset voltage at the input voltage range limits to a maximum of 2.3mV (A grade) to 2.8mV (C grade).

**Note 6:** This parameter is not 100% tested.

**Note 7:** Slew rate is measured in  $A_V = -1$ ; input signal is  $\pm 7.5\text{V}$ , output measured at  $\pm 2.5\text{V}$ .

**Note 8:** The LT1793AC and LT1793C are guaranteed to meet specified performance from  $0^{\circ}\text{C}$  to  $70^{\circ}\text{C}$  and are designed, characterized and expected to meet these extended temperature limits, but are not tested at  $-40^{\circ}\text{C}$  and  $85^{\circ}\text{C}$ . The LT1793I is guaranteed to meet the extended temperature limits. The LT1793AC and LT1793AI grade are 100% temperature tested for the specified temperature range.

**Note 9:** The LT1793 is measured in an automated tester in less than one second after application of power. Depending on the package used, power dissipation, heat sinking, and air flow conditions, the fully warmed-up chip temperature can be  $10^{\circ}\text{C}$  to  $50^{\circ}\text{C}$  higher than the ambient temperature.

# TYPICAL PERFORMANCE CHARACTERISTICS

0.1Hz to 10Hz Voltage Noise

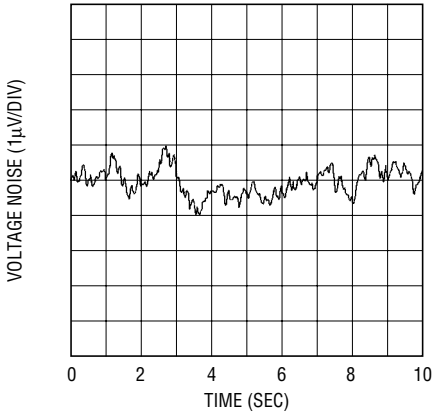

1793 G01

1kHz Input Noise Voltage Distribution



1793 G02

Voltage Noise vs Frequency

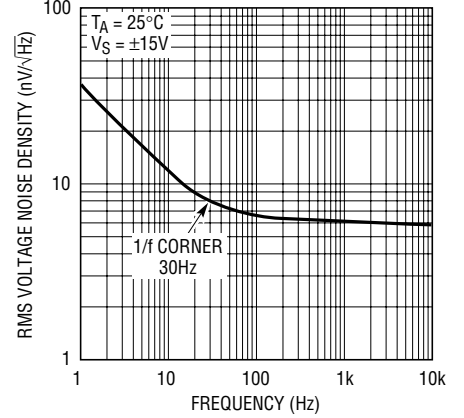

1793 G03

Voltage Noise vs Chip Temperature

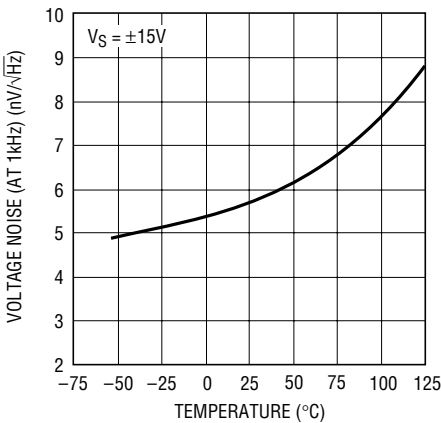

1793 G04

Common Mode Limit vs Temperature

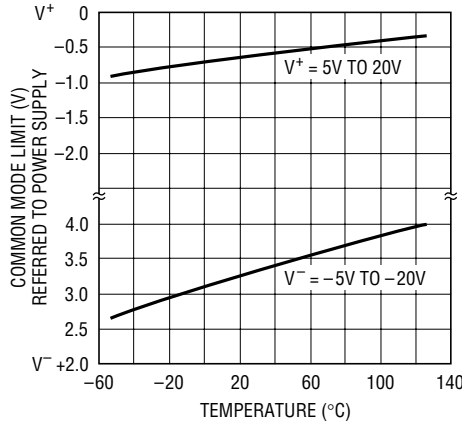

1793 G05

Common Mode Rejection Ratio vs Frequency

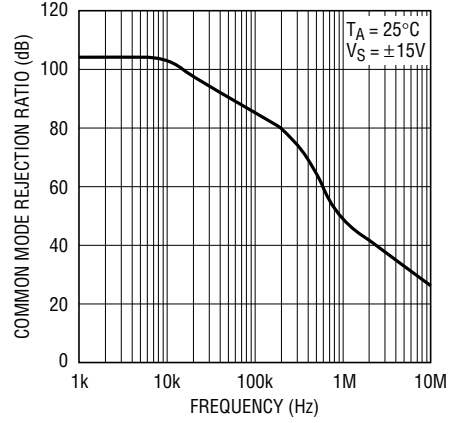

1793 G06

Power Supply Rejection Ratio vs Frequency

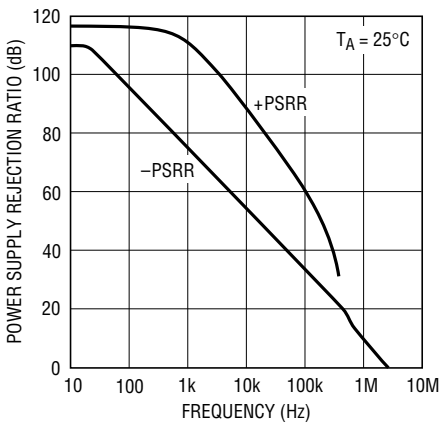

1793 G07

Voltage Gain vs Frequency

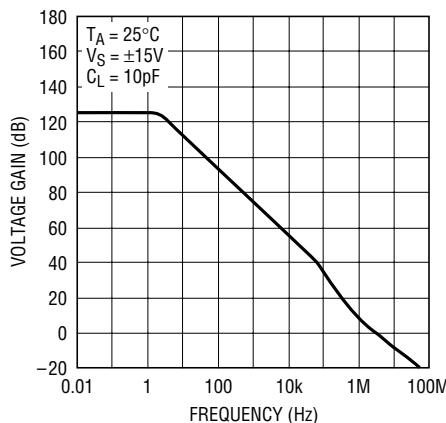

1793 G08

Gain and Phase Shift vs Frequency

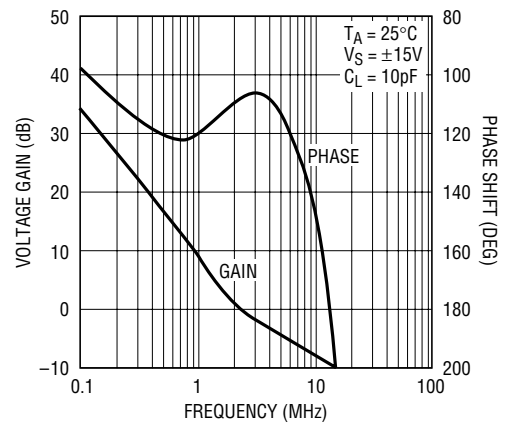

1793 G09

# TYPICAL PERFORMANCE CHARACTERISTICS

**Small-Signal Transient Response**

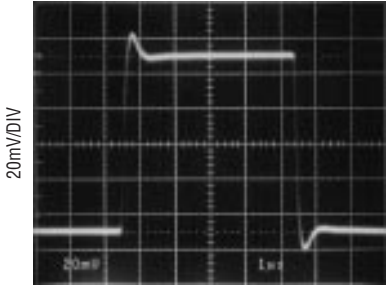

$A_V = 1$   
 $C_L = 10\text{pF}$   
 $V_S = \pm 15\text{V}, \pm 5\text{V}$

**Large-Signal Transient Response**

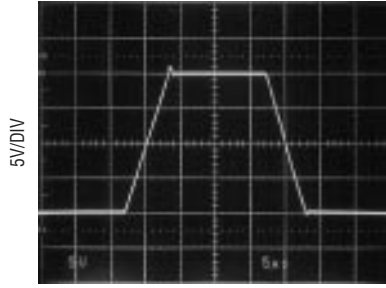

$A_V = 1$   
 $C_L = 10\text{pF}$   
 $R_L = 2\text{k}$   
 $V_S = \pm 15\text{V}$

**Output Voltage Swing vs Load Current**

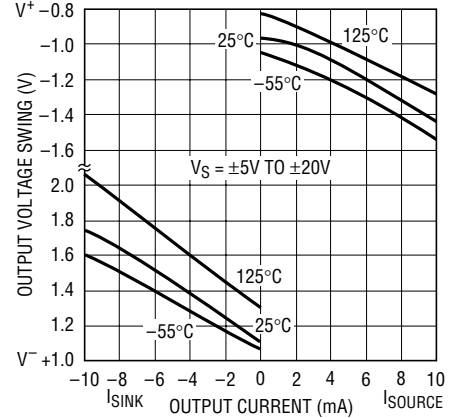

1793 G12

**Capacitive Load Handling**

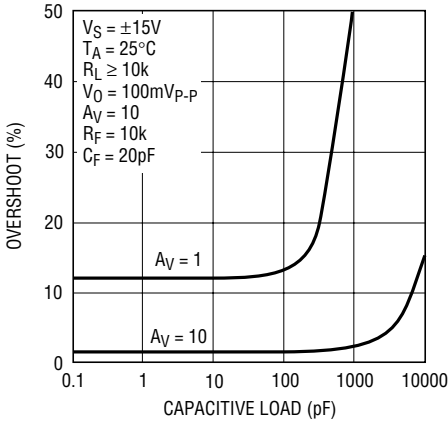

1793 G13

**Warm-Up Drift**

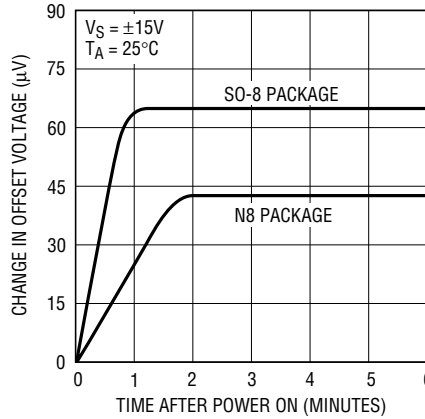

1793 G14

**THD and Noise Frequency for Noninverting Gain**

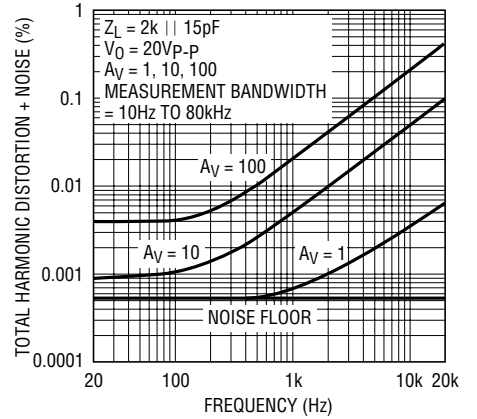

1793 G15

**THD and Noise vs Frequency for Inverting Gain**

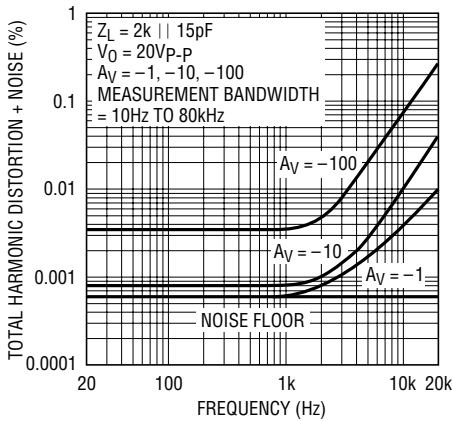

1793 G16

**THD and Noise vs Output Amplitude for Inverting Gain**

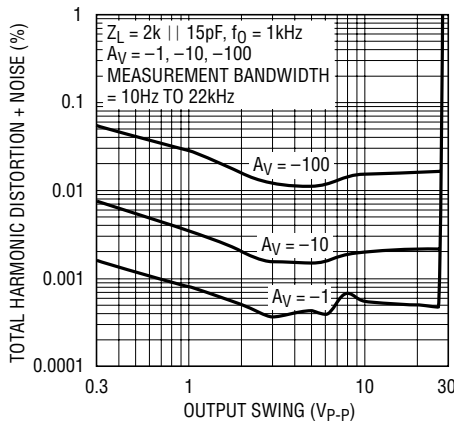

1793 G17

**THD and Noise vs Output Amplitude for Noninverting Gain**

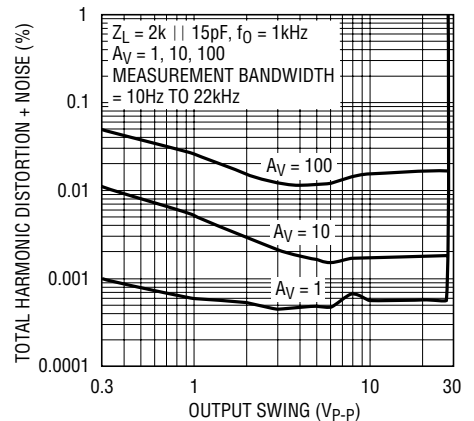

1793 G18

# TYPICAL PERFORMANCE CHARACTERISTICS

**Short-Circuit Output Current vs Temperature**



1793 G19

**Supply Current vs Temperature**

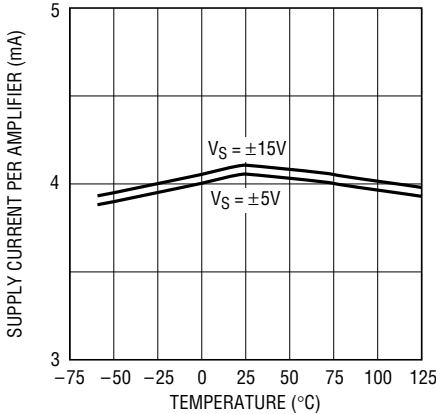

1793 G20

**Input Bias and Offset Currents vs Chip Temperature**



1793 G21

# APPLICATIONS INFORMATION

## LT1793 vs the Competition

With improved noise performance, the LT1793 in the PDIP directly replaces such JFET op amps as the OPA111 and the AD645. The combination of low current and voltage noise of the LT1793 allows it to surpass most dual and single JFET op amps. The LT1793 can replace many of the lowest noise bipolar amps that are used in amplifying low level signals from high impedance transducers. The best bipolar op amps (with higher current noise) will eventually lose out to the LT1793 when transducer impedance increases.

The extremely high input impedance ( $10^{13}\Omega$ ) assures that the input bias current is almost constant over the entire common mode range. Figure 1 shows how the LT1793 stands up to the competition. Unlike the competition, as the input voltage is swept across the entire common mode range the input bias current of the LT1793 hardly changes. As a result the current noise does not degrade. This makes the LT1793 the best choice in applications where an amplifier has to buffer signals from a high impedance transducer.

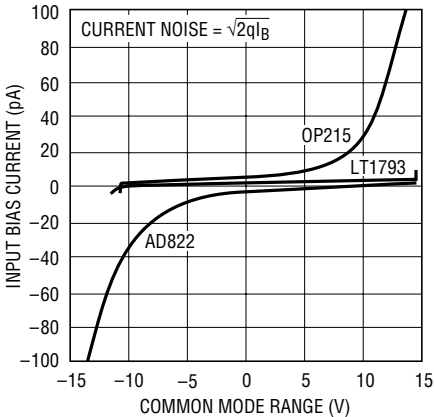

1793 F01

Offset nulling will be compatible with these devices with the wiper of the potentiometer tied to the negative supply (Figure 2a). No appreciable change in offset voltage drift

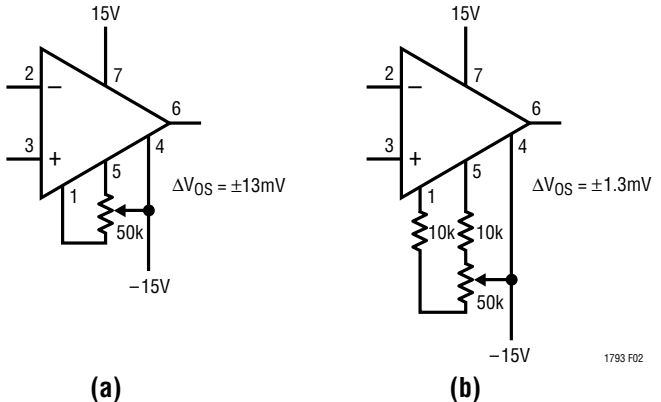

1793 F02

**Figure 1. Comparison of LT1793, OP215, and AD822 Input Bias Current vs Common Mode Range**

**Figure 2**

## APPLICATIONS INFORMATION

with temperature will occur when the device is nulled with a potentiometer ranging from 10k to 200k. Finer adjustments can be made with resistors in series with the potentiometer (Figure 2b).

### Amplifying Signals from High Impedance Transducers

The low voltage and current noise offered by the LT1793 makes it useful in a wide range of applications, especially where high impedance, capacitive transducers are used such as hydrophones, precision accelerometers and photodiodes. The total output noise in such a system is the gain times the RMS sum of the op amp's input referred

voltage noise, the thermal noise of the transducer, and the op amp's input bias current noise times the transducer impedance. Figure 3 shows total input voltage noise versus source resistance. In a low source resistance (<5k) application the op amp voltage noise will dominate the total noise. This means the LT1793 is superior to most JFET op amps. Only the lowest noise bipolar op amps have the advantage at low source resistances. As the source resistance increases from 5k to 50k, the LT1793 will match the best bipolar op amps for noise performance, since the thermal noise of the transducer (4kTR) begins to dominate the total noise. A further increase in source resistance, above 50k, is where the op amp's current noise component ( $2qI_B R^2$ ) will eventually dominate the total noise. At these high source resistances, the LT1793 will out perform the lowest noise bipolar op amps due to the inherently low current noise of FET input op amps. Clearly, the LT1793 will extend the range of high impedance transducers that can be used for high signal-to-noise ratios. This makes the LT1793 the best choice for high impedance, capacitive transducers.

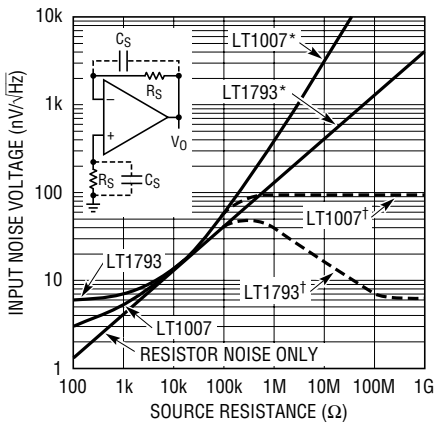

SOURCE RESISTANCE =  $2R_S = R$   
 \* PLUS RESISTOR  
 † PLUS RESISTOR || 1000pF CAPACITOR  
 $V_n = A_V \sqrt{V_n^2(\text{OP AMP}) + 4kTR + 2qI_B R^2}$

Figure 3. Comparison of LT1793 and LT1007 Total Output 1kHz Voltage Noise vs Source Resistance

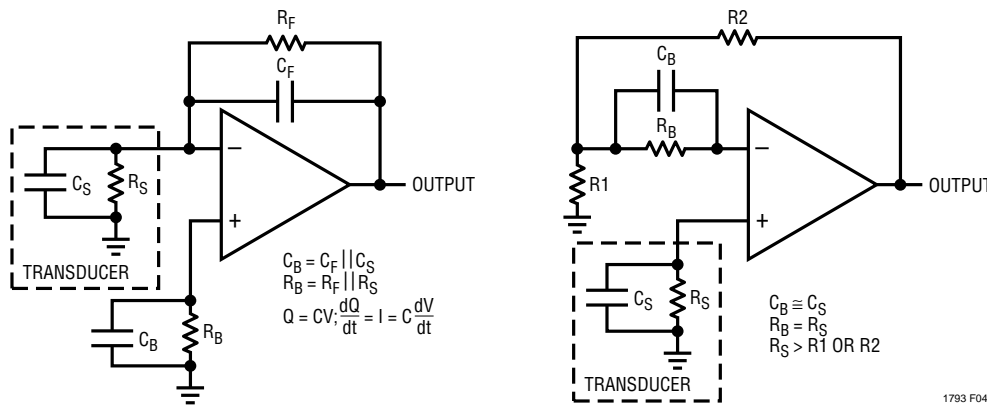

Figure 4. Inverting and Noninverting Gain Configurations



## APPLICATIONS INFORMATION

resulting in a change in voltage  $dV$ , which is equal to  $dQ/C_F$ . The gain therefore is  $C_F/C_S$ . For unity-gain, the  $C_F$  should equal the transducer capacitance plus the input capacitance of the LT1793 and  $R_F$  should equal  $R_S$ .

In the noninverting mode example, the transducer current is converted to a change in voltage by the transducer capacitance,  $C_S$ . This voltage is then buffered by the LT1793 with a gain of  $1 + R1/R2$ . A DC path is provided by  $R_S$ , which is either the transducer impedance or an external resistor. Since  $R_S$  is usually several orders of magnitude greater than the parallel combination of  $R1$  and  $R2$ ,  $R_B$  is added to balance the DC offset caused by the noninverting input bias current and  $R_S$ . The input bias currents, although small at room temperature, can create significant errors at higher temperature, especially with transducer resistances of up to 1000M or more. The optimum value

for  $R_B$  is determined by equating the thermal noise ( $4kTR_S$ ) to the current noise ( $2qI_B$ ) times  $R_S^2$ . Solving for  $R_S$  results in  $R_B = R_S = 2V_T/I_B$  ( $V_T = 26mV$  at  $25^\circ C$ ). A parallel capacitor  $C_B$ , is used to cancel the phase shift caused by the op amp input capacitance and  $R_B$ .

### Reduced Power Supply Operation

To take full advantage of a wide input common mode range, the LT1793 was designed to eliminate phase reversal. Referring to the photographs in Figure 5, the LT1793 is shown operating in the follower mode ( $A_V = 1$ ) at  $\pm 5V$  supplies with the input swinging  $\pm 5.2V$ . The output of the LT1793 clips cleanly and recovers with no phase reversal. This has the benefit of preventing lockup in servo systems and minimizing distortion components.

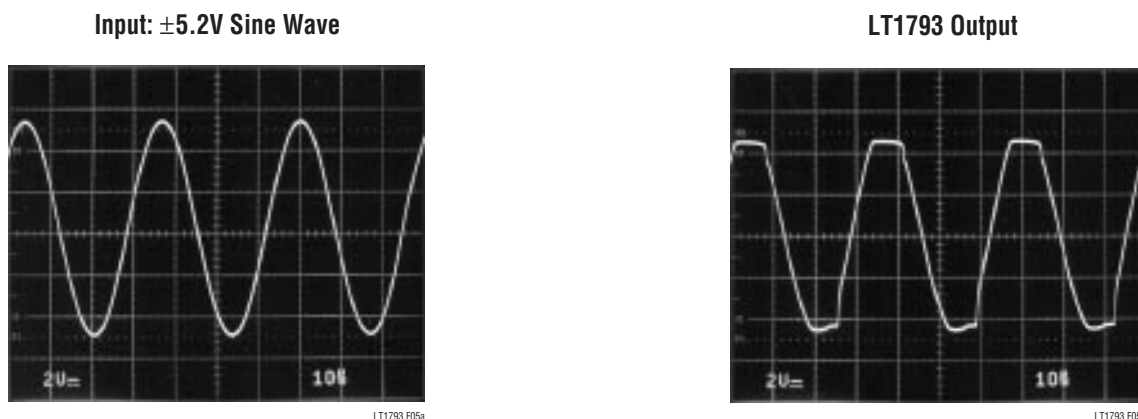

Figure 5. Voltage Follower with Input Exceeding the Common Mode Range ( $V_S = \pm 5V$ )

**PACKAGE DESCRIPTION** Dimensions in inches (millimeters) unless otherwise noted.

**N8 Package**  
**8-Lead PDIP (Narrow 0.300)**  
 (LTC DWG # 05-08-1510)



\*THESE DIMENSIONS DO NOT INCLUDE MOLD FLASH OR PROTRUSIONS.  
 MOLD FLASH OR PROTRUSIONS SHALL NOT EXCEED 0.010 INCH (0.254mm)

**PACKAGE DESCRIPTION** Dimensions in inches (millimeters) unless otherwise noted.

**S8 Package**  
**8-Lead Plastic Small Outline (Narrow 0.150)**  
 (LTC DWG # 05-08-1610)



\*DIMENSION DOES NOT INCLUDE MOLD FLASH. MOLD FLASH SHALL NOT EXCEED 0.006" (0.152mm) PER SIDE  
 \*\*DIMENSION DOES NOT INCLUDE INTERLEAD FLASH. INTERLEAD FLASH SHALL NOT EXCEED 0.010" (0.254mm) PER SIDE

S08 0996

## TYPICAL APPLICATIONS

10Hz Fourth Order Chebyshev Lowpass Filter (0.01dB Ripple)

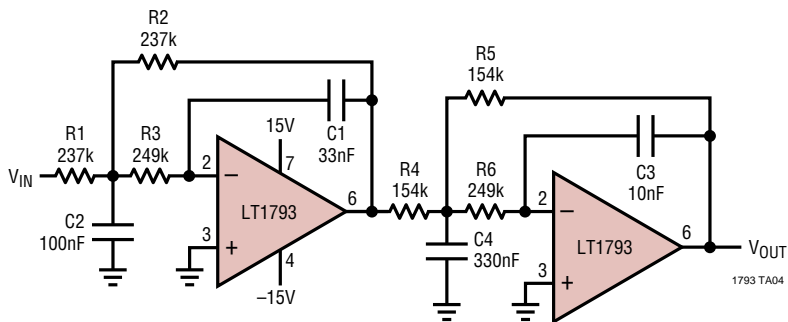

TYPICAL OFFSET  $\approx$  0.8mV  
 1% TOLERANCES  
 FOR  $V_{IN} = 10V_{P-P}$ ,  $V_{OUT} = -121dB$  AT  $f > 330Hz$   
 $= -6dB$  AT  $f = 16.3Hz$   
 LOWER RESISTOR VALUES WILL RESULT IN LOWER THERMAL NOISE AND LARGER CAPACITORS

Accelerometer Amplifier with DC Servo

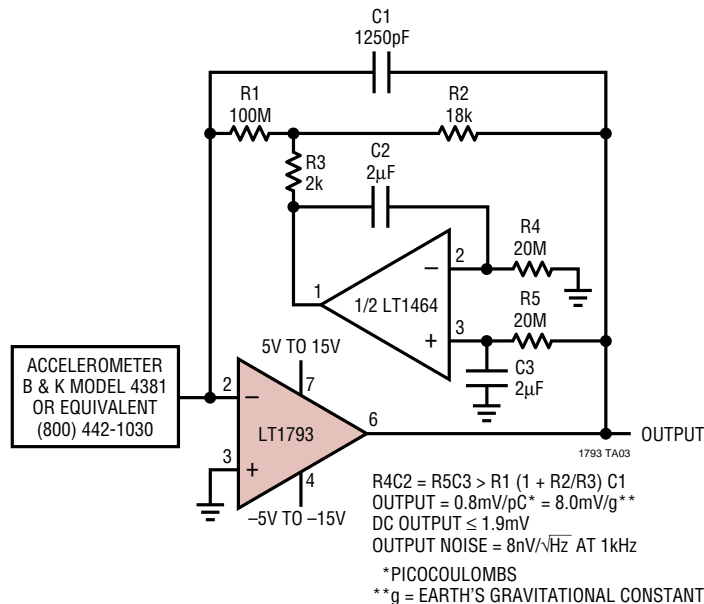

## RELATED PARTS

PART NUMBER	DESCRIPTION	COMMENTS
LT1113	Low Noise, Dual JFET Op Amp	Dual Version of LT1792, $V_{NOISE} = 4.5nV/\sqrt{Hz}$
LT1169	Low Noise, Dual JFET Op Amp	Dual Version of LT1793, $V_{NOISE} = 6nV/\sqrt{Hz}$ , $I_B = 10pA$
LT1467	Micropower Dual JFET Op Amp	1MHz, 2pA Max $I_B$ , 200 $\mu A$ Max $I_S$
LT1792	Low Noise, Single JFET Op Amp	Lower $V_{NOISE}$ Version of LT1793, $V_{NOISE} = 4.2nV/\sqrt{Hz}$



Компания «ЭлектроПласт» предлагает заключение долгосрочных отношений при поставках импортных электронных компонентов на взаимовыгодных условиях!

Наши преимущества:

- Оперативные поставки широкого спектра электронных компонентов отечественного и импортного производства напрямую от производителей и с крупнейших мировых складов;
- Поставка более 17-ти миллионов наименований электронных компонентов;
- Поставка сложных, дефицитных, либо снятых с производства позиций;
- Оперативные сроки поставки под заказ (от 5 рабочих дней);
- Экспресс доставка в любую точку России;
- Техническая поддержка проекта, помощь в подборе аналогов, поставка прототипов;
- Система менеджмента качества сертифицирована по Международному стандарту ISO 9001;
- Лицензия ФСБ на осуществление работ с использованием сведений, составляющих государственную тайну;
- Поставка специализированных компонентов (Xilinx, Altera, Analog Devices, Intersil, Interpoint, Microsemi, Aeroflex, Peregrine, Syfer, Eurofarad, Texas Instrument, Miteq, Cobham, E2V, MA-COM, Hittite, Mini-Circuits, General Dynamics и др.);

Помимо этого, одним из направлений компании «ЭлектроПласт» является направление «Источники питания». Мы предлагаем Вам помощь Конструкторского отдела:

- Подбор оптимального решения, техническое обоснование при выборе компонента;
- Подбор аналогов;
- Консультации по применению компонента;
- Поставка образцов и прототипов;
- Техническая поддержка проекта;
- Защита от снятия компонента с производства.



#### Как с нами связаться

**Телефон:** 8 (812) 309 58 32 (многоканальный)

**Факс:** 8 (812) 320-02-42

**Электронная почта:** [org@eplast1.ru](mailto:org@eplast1.ru)

**Адрес:** 198099, г. Санкт-Петербург, ул. Калинина, дом 2, корпус 4, литера А.