

## Ultra Fast NPT - IGBT®

The Ultra Fast 650V NPT-IGBT® family of products is the newest generation of IGBTs optimized for outstanding ruggedness and best trade-off between conduction and switching losses.

### Features

- Low Saturation Voltage
- Low Tail Current
- RoHS Compliant 
- Short Circuit Withstand Rated
- High Frequency Switching
- Ultra Low Leakage Current

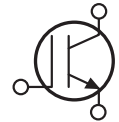
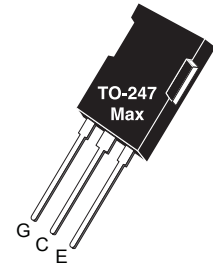

Unless stated otherwise, Microsemi discrete IGBTs contain a single IGBT die. This device is recommended for applications such as induction heating (IH), motor control, general purpose inverters and uninterruptible power supplies (UPS).

### MAXIMUM RATINGS

All Ratings:  $T_C = 25^\circ\text{C}$  unless otherwise specified.

Symbol	Parameter	Ratings	Unit
$V_{CES}$	Collector Emitter Voltage	650	V
$V_{GE}$	Gate-Emitter Voltage	$\pm 30$	
$I_{C1}$	Continuous Collector Current @ $T_C = 25^\circ\text{C}$	208	A
$I_{C2}$	Continuous Collector Current @ $T_C = 110^\circ\text{C}$	100	
$I_{CM}$	Pulsed Collector Current <sup>①</sup>	400	
SCWT	Short Circuit Withstand Time: $V_{CE} = 325\text{V}$ , $V_{GE} = 15\text{V}$ , $T_C = 125^\circ\text{C}$	10	$\mu\text{s}$
$P_D$	Total Power Dissipation @ $T_C = 25^\circ\text{C}$	892	W
$T_J, T_{STG}$	Operating and Storage Junction Temperature Range	-55 to 150	$^\circ\text{C}$
$T_L$	Max. Lead Temp. for Soldering: 0.063" from Case for 10 Sec.	300	

### STATIC ELECTRICAL CHARACTERISTICS

Symbol	Parameter	Min	Typ	Max	Unit
$V_{(BR)CES}$	Collector-Emitter Breakdown Voltage ( $V_{GE} = 0\text{V}$ , $I_C = 250\mu\text{A}$ )	650			Volts
$V_{GE(TH)}$	Gate Threshold Voltage ( $V_{CE} = V_{GE}$ , $I_C = 2.5\text{mA}$ , $T_J = 25^\circ\text{C}$ )	3.5	5.0	6.5	
$V_{CE(ON)}$	Collector-Emitter On Voltage ( $V_{GE} = 15\text{V}$ , $I_C = 95\text{A}$ , $T_J = 25^\circ\text{C}$ )		1.9	2.4	
	Collector-Emitter On Voltage ( $V_{GE} = 15\text{V}$ , $I_C = 95\text{A}$ , $T_J = 125^\circ\text{C}$ )		2.4		
	Collector-Emitter On Voltage ( $V_{GE} = 15\text{V}$ , $I_C = 190\text{A}$ , $T_J = 25^\circ\text{C}$ )		2.6		
$I_{CES}$	Collector Cut-off Current ( $V_{CE} = 650\text{V}$ , $V_{GE} = 0\text{V}$ , $T_J = 25^\circ\text{C}$ ) <sup>②</sup>		10	250	$\mu\text{A}$
	Collector Cut-off Current ( $V_{CE} = 650\text{V}$ , $V_{GE} = 0\text{V}$ , $T_J = 125^\circ\text{C}$ ) <sup>②</sup>		100		
$I_{GES}$	Gate-Emitter Leakage Current ( $V_{GE} = \pm 20\text{V}$ )			$\pm 250$	nA



**CAUTION: These Devices are Sensitive to Electrostatic Discharge. Proper Handling Procedures Should Be Followed.**

DYNAMIC CHARACTERISTICS

APT95GR65B2

Symbol	Parameter	Test Conditions	Min	Typ	Max	Unit
$C_{ies}$	Input Capacitance	Capacitance $V_{GE} = 0V, V_{CE} = 25V$ $f = 1MHz$		5910		pF
$C_{oes}$	Output Capacitance			1150		
$C_{res}$	Reverse Transfer Capacitance			565		
$V_{GEP}$	Gate to Emitter Plateau Voltage	Gate Charge		7.5		V
$Q_g^{(3)}$	Total Gate Charge	$V_{GE} = 15V$		312	420	nC
$Q_{ge}$	Gate-Emitter Charge	$V_{CE} = 325V$		42	55	
$Q_{gc}$	Gate- Collector Charge	$I_C = 95A$		154	210	
$t_{d(on)}$	Turn-On Delay Time	Inductive Switching (25°C) $V_{CC} = 433V$ $V_{GE} = 15V$ $I_C = 95A$ $R_G = 4.3\Omega^{(4)}$ $T_J = +25^\circ C$		29		ns
$t_r$	Current Rise Time			76		
$t_{d(off)}$	Turn-Off Delay Time			226		
$t_f$	Current Fall Time			84		
$E_{on2}^{(5)}$	Turn-On Switching Energy			3120	4680	μJ
$E_{off}^{(6)}$	Turn-Off Switching Energy			2550	3830	
$t_{d(on)}$	Turn-On Delay Time	Inductive Switching (125°C) $V_{CC} = 433V$ $V_{GE} = 15V$ $I_C = 95A$ $R_G = 4.3\Omega^{(4)}$ $T_J = +125^\circ C$		29		ns
$t_r$	Current Rise Time			76		
$t_{d(off)}$	Turn-Off Delay Time			246		
$t_f$	Current Fall Time			90		
$E_{on2}^{(5)}$	Turn-On Switching Energy			3155	4730	μJ
$E_{off}^{(6)}$	Turn-Off Switching Energy			2745	4120	

THERMAL AND MECHANICAL CHARACTERISTICS

Symbol	Characteristic	Min	Typ	Max	Unit
$R_{\theta JC}$	Junction to Case Thermal Resistance			.14	°C/W
$R_{\theta JA}$	Junction to Ambient Thermal Resistance			40	
$W_T$	Package Weight		.22		oz
			6.2		g

- 1 Repetitive Rating: Pulse width and case temperature limited by maximum junction temperature.
  - 2 Pulse test: Pulse Width < 380μs, duty cycle < 2%.
  - 3 See Mil-Std-750 Method 3471.
  - 4  $R_G$  is external gate resistance, not including internal gate resistance or gate driver impedance. (MIC4452)
  - 5  $E_{on2}$  is the energy loss at turn-on and includes the charge stored in the freewheeling diode.
  - 6  $E_{off}$  is the clamped inductive turn-off energy measured in accordance with JEDEC standard JESD24-1.
- Microsemi reserves the right to change, without notice, the specifications and information contained herein.

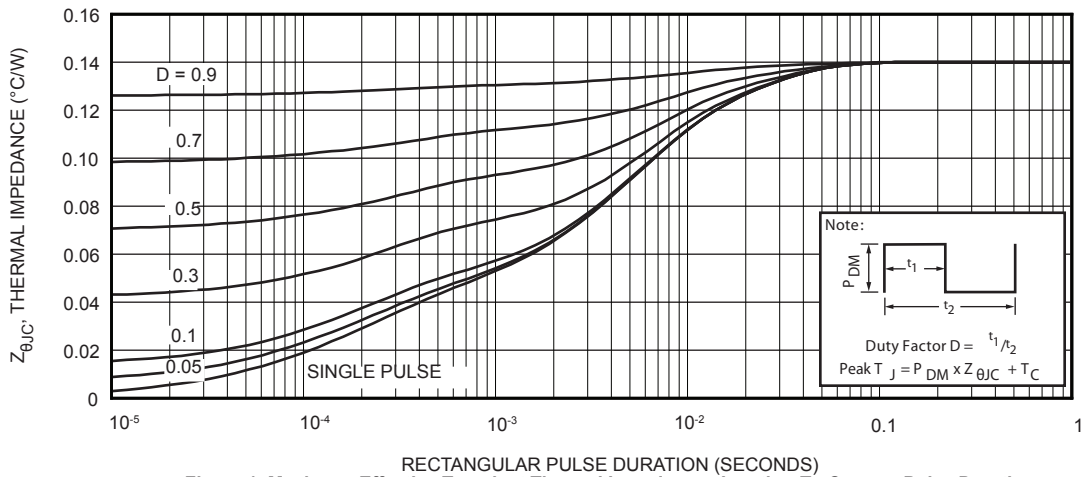

Figure 1, Maximum Effective Transient Thermal Impedance, Junction-To-Case vs Pulse Duration

TYPICAL PERFORMANCE CURVES

AP95GR65B2

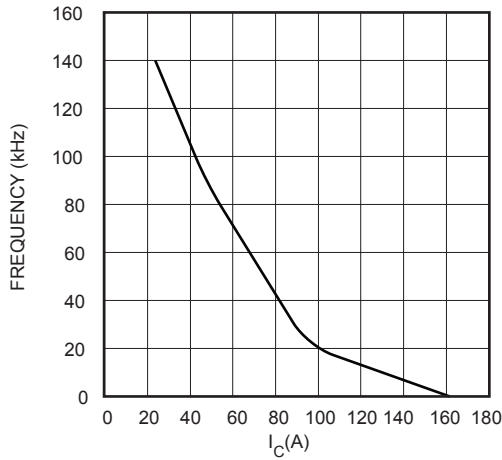

FIGURE 2, Max Frequency vs Current ( $T_C = 75^\circ\text{C}$ )

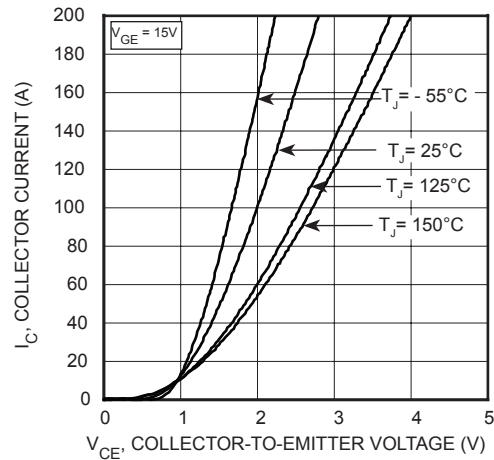

FIGURE 3, Saturation Voltage Characteristics ( $T_J = 25^\circ\text{C}$ )

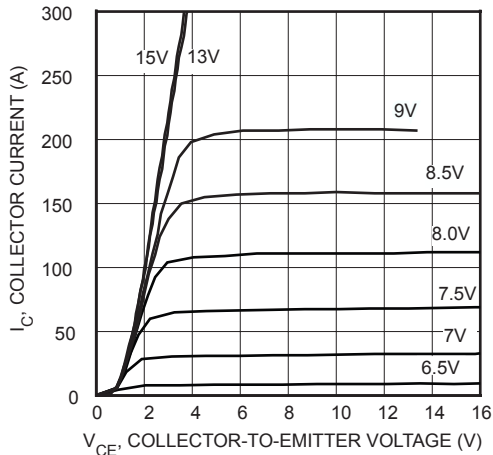

FIGURE 4, Output Characteristics ( $T_J = 25^\circ\text{C}$ )

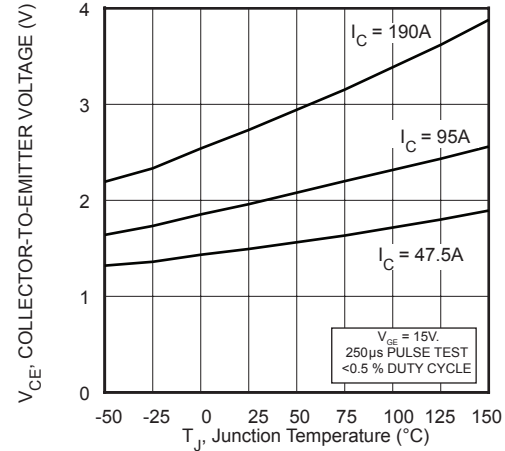

FIGURE 5, On State Voltage vs Junction Temperature

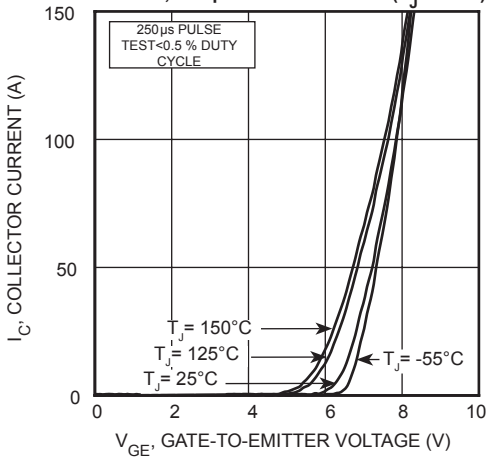

FIGURE 6, Transfer Characteristics

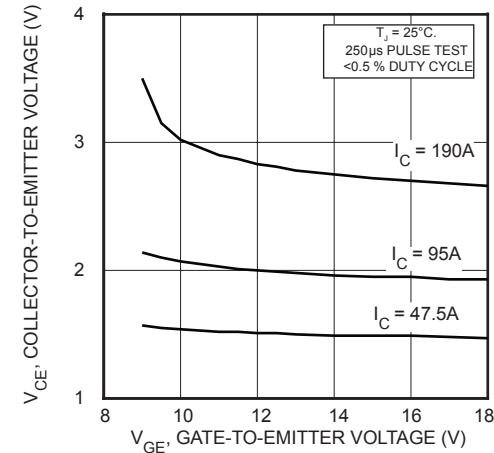

FIGURE 7, On State Voltage vs Gate-to-Emitter Voltage

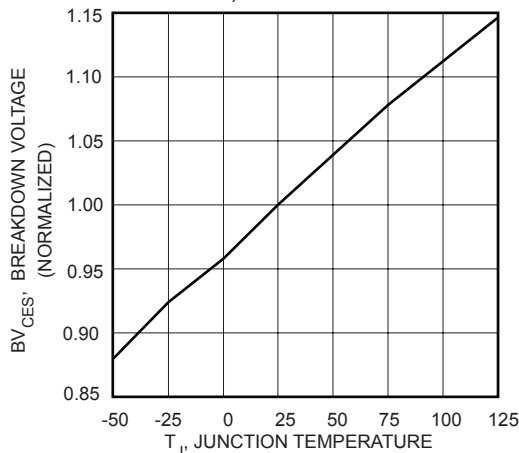

FIGURE 8, Breakdown Voltage vs Junction Temperature

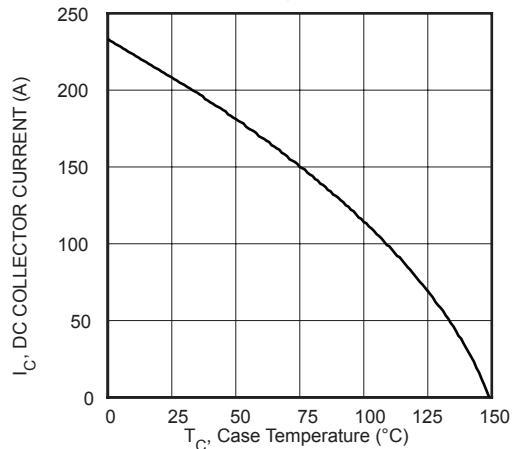

FIGURE 9, DC Collector Current vs Case Temperature

TYPICAL PERFORMANCE CURVES

APT95GR65B2

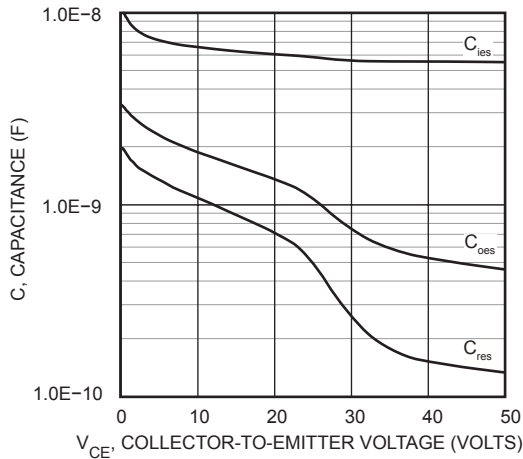

FIGURE 10, Capacitance vs Collector-To-Emitter Voltage

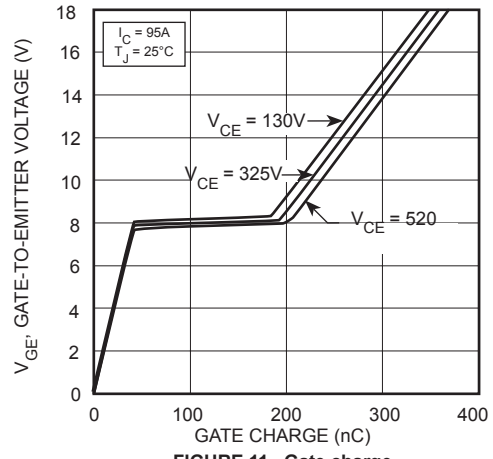

FIGURE 11, Gate charge

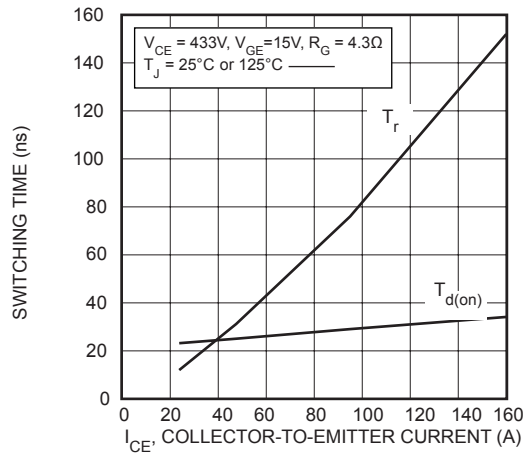

FIGURE 12, Turn-On Time vs Collector Current

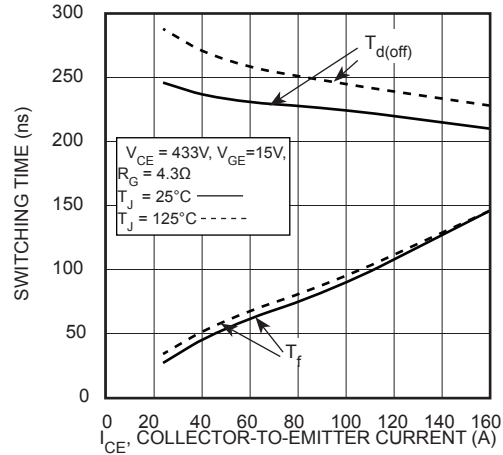

FIGURE 13, Turn-Off Time vs Collector Current

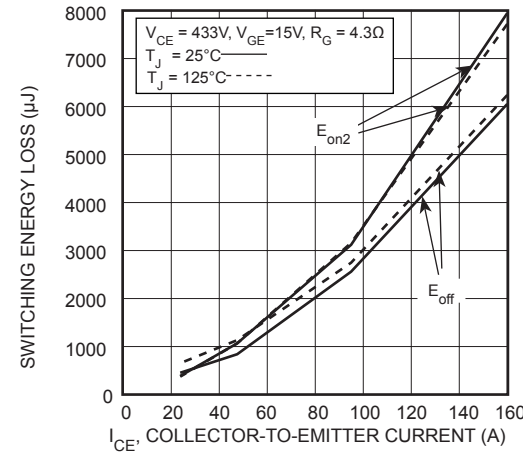

FIGURE 14, Energy Loss vs Collector Current

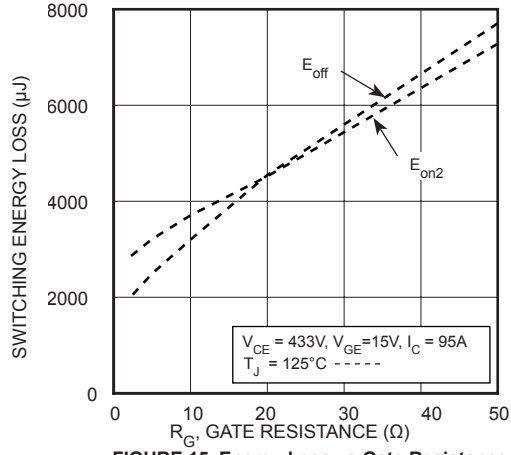

FIGURE 15, Energy Loss vs Gate Resistance

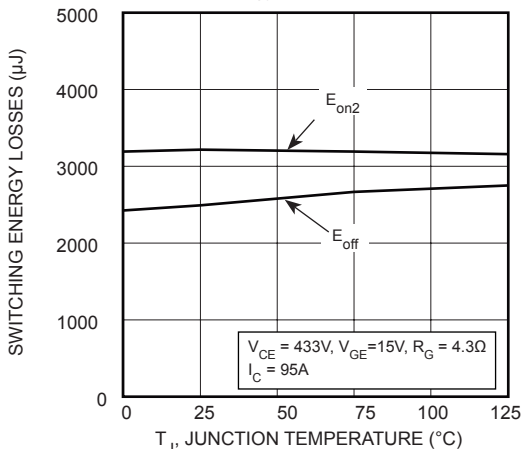

FIGURE 16, Switching Energy vs Junction Temperature

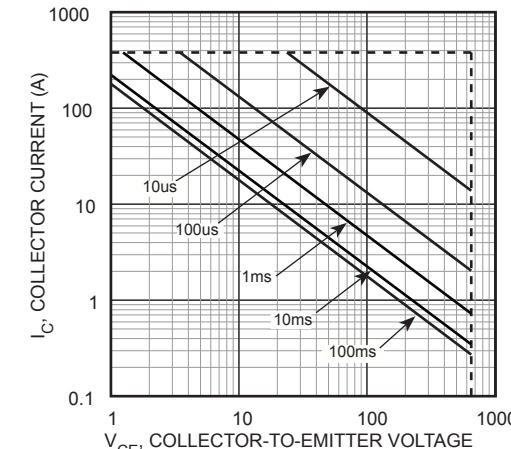
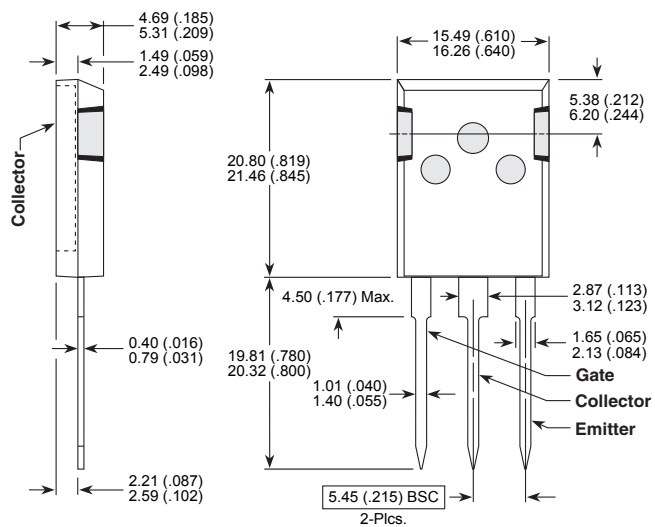

FIGURE 17, Minimum Switching Safe Operating Area

**T-MAX™ (B2) Package Outline**



These dimensions are equal to the TO-247 without the mounting hole.  
 Dimensions in Millimeters and (Inches)

The information contained in the document (unless it is publicly available on the Web without access restrictions) is PROPRIETARY AND CONFIDENTIAL information of Microsemi and cannot be copied, published, uploaded, posted, transmitted, distributed or disclosed or used without the express duly signed written consent of Microsemi. If the recipient of this document has entered into a disclosure agreement with Microsemi, then the terms of such Agreement will also apply. This document and the information contained herein may not be modified, by any person other than authorized personnel of Microsemi. No license under any patent, copyright, trade secret or other intellectual property right is granted to or conferred upon you by disclosure or delivery of the information, either expressly, by implication, inducement, estoppels or otherwise. Any license under such intellectual property rights must be approved by Microsemi in writing signed by an officer of Microsemi.

Microsemi reserves the right to change the configuration, functionality and performance of its products at anytime without any notice. This product has been subject to limited testing and should not be used in conjunction with life-support or other mission-critical equipment or applications. Microsemi assumes no liability whatsoever, and Microsemi disclaims any express or implied warranty, relating to sale and/or use of Microsemi products including liability or warranties relating to fitness for a particular purpose, merchantability, or infringement of any patent, copyright or other intellectual property right. Any performance specifications believed to be reliable but are not verified and customer or user must conduct and complete all performance and other testing of this product as well as any user or customers final application. User or customer shall not rely on any data and performance specifications or parameters provided by Microsemi. It is the customer's and user's responsibility to independently determine suitability of any Microsemi product and to test and verify the same. The information contained herein is provided "AS IS, WHERE IS" and with all faults, and the entire risk associated with such information is entirely with the User. Microsemi specifically disclaims any liability of any kind including for consequential, incidental and punitive damages as well as lost profit. The product is subject to other terms and conditions which can be located on the web at <http://www.microsemi.com/legal/tnc.asp>



Компания «ЭлектроПласт» предлагает заключение долгосрочных отношений при поставках импортных электронных компонентов на взаимовыгодных условиях!

Наши преимущества:

- Оперативные поставки широкого спектра электронных компонентов отечественного и импортного производства напрямую от производителей и с крупнейших мировых складов;
- Поставка более 17-ти миллионов наименований электронных компонентов;
- Поставка сложных, дефицитных, либо снятых с производства позиций;
- Оперативные сроки поставки под заказ (от 5 рабочих дней);
- Экспресс доставка в любую точку России;
- Техническая поддержка проекта, помощь в подборе аналогов, поставка прототипов;
- Система менеджмента качества сертифицирована по Международному стандарту ISO 9001;
- Лицензия ФСБ на осуществление работ с использованием сведений, составляющих государственную тайну;
- Поставка специализированных компонентов (Xilinx, Altera, Analog Devices, Intersil, Interpoint, Microsemi, Aeroflex, Peregrine, Syfer, Eurofarad, Texas Instrument, Miteq, Cobham, E2V, MA-COM, Hittite, Mini-Circuits, General Dynamics и др.);

Помимо этого, одним из направлений компании «ЭлектроПласт» является направление «Источники питания». Мы предлагаем Вам помощь Конструкторского отдела:

- Подбор оптимального решения, техническое обоснование при выборе компонента;
- Подбор аналогов;
- Консультации по применению компонента;
- Поставка образцов и прототипов;
- Техническая поддержка проекта;
- Защита от снятия компонента с производства.



#### Как с нами связаться

**Телефон:** 8 (812) 309 58 32 (многоканальный)

**Факс:** 8 (812) 320-02-42

**Электронная почта:** [org@eplast1.ru](mailto:org@eplast1.ru)

**Адрес:** 198099, г. Санкт-Петербург, ул. Калинина, дом 2, корпус 4, литера А.