

**KUP Series Panel Plug-in Relay**

- AC coils: 5-240VAC, 50/60 Hz.; DC coils 6-110VDC
- Contact arrangements of 1 form X, 1-3 form A and 1-4 form C
- Wide selection of termination and mounting styles
- PC terminals available
- Push-to-test button and indicator lamp options
- Sockets available for panel, DIN rail or PCB mounting
- Class B coil insulation



Typical applications

Vending, commercial sewing, tool/die equipment, robotics, timers, welding, HVAC, medical, power generators

**Approvals**

UL E22575; CSA LR15734

Technical data of approved types on request

**Contact Data**

Contact arrangement	1 Form X (NO-DM); 1-3 Form A (NO); 1-4 Form C (CO)		
Rated voltage	240VAC		
Rated current	10A		
Contact material	Ag	AgCdO	AgSnOInO
Min. recommended contact load	100mA, 12VDC	300mA, 12VDC	300mA, 12VDC
Frequency of operation	360 ops./hr	360 ops./hr	360 ops./hr
Operate/releases time max.	15/10ms		
Bounce time max.	17ms		

**Contact ratings**

Type	Load	Cycles
<b>UL 508</b>		
Ag, 1, 2 and 3 pole		
	5A, 240VAC	
	5A, 28VDC	
	1/6HP, 120VAC	
	2.5A, 120VAC, tungsten	
	1/3HP, 240VAC	
	0.5A, 120VDC	
	5FLA, 15LRA, 250VAC	
Ag, 4 pole		
	5A, 240VAC	
	2.5A, 120VAC, tungsten	
	0.5A, 120VDC	
	1/6HP, 120VAC	
	1/3HP, 240VAC	
AgCdO, 1, 2 and 3 pole		
	10A, 240VAC	
	10A, 32VDC	
	5FLA, 15LRA, 250VAC	
	1/3HP, 120VAC	
	5A, 120VAC, tungsten	
	1/2HP, 250VAC	
	0.5A, 125VDC	
	10FLA, 40LRA, 125VAC	
	3A, 600VAC	
	1/2HP, 480VAC	
	1/2HP, 600VAC	
	1HP, 480 VAC, 3 phase	
AgCdO, 4 pole		
	10A, 240VAC	
	5A, 120VAC, tungsten	
	0.5A, 120VDC	
	10A, 28VDC, resistive	
	10FLA, 30LRA, 125VAC	
	5FLA, 15LRA, 250 VAC	30x10 <sup>3</sup>
	125VA, 250 VAC	

AgCdO, 4 pole (continued)

1/3HP, 120VAC

1/2HP, 250VAC

Total load not to exceed 30 A, 28 VDC, 120 VAC and 20 A, 250 VAC

AgSnOInO

10A, 277VAC, pf = 0.8

100x10<sup>3</sup>

Mechanical endurance 10x10<sup>6</sup> ops.

**Coil Data**

Coil voltage range	5 to 110VDC 6 to 240VAC			
Coil insulation system according UL	Class B			
<b>Coil versions, DC coil</b>				
Coil code	Rated voltage VDC	Operate voltage VDC	Coil resistance Ω±10%	Rated power W
1, 2 and 3 pole				
5	5	3.75	21	1.2
6	6	4.5	32.1	1.125
12	12	9.0	120	1.2
24	24	18.0	472	1.25
48	48	36.0	1800	1.3
110	110	82.5	10000	1.25
4 pole				
5	5	3.75	14	1.8
6	6	4.5	20	1.8
12	12	9.0	80	1.8
24	24	18.0	320	1.8
48	48	36.0	1250	1.85
110	110	82.5	6720	1.8

All figures are given for coil without preenergization, at ambient temperature +23°C.

**Coil versions, AC coil**

Coil code	Rated voltage VAC	Operate voltage VAC	Coil resistance Ω±15%	Rated power VA
1 and 2 pole				
6	6	5.1	6	2.0
12	12	10.2	24	2.0
24	24	20.4	85	2.0
120	120	102.0	2250	2.1
240	240	204.0	9110	2.1
3 and 4 pole				
6	6	5.1	4.2	2.8
12	12	10.2	18	2.8
24	24	20.4	72	2.8
120	120	102.0	1700	2.9
240	240	204.0	7200	2.9

All figures are given for coil without preenergization, at ambient temperature +23°C.

**KUP Series Panel Plug-in Relay** (Continued)

**Insulation Data**

Initial dielectric strength	
between open contacts	1200V <sub>rms</sub>
between contact and coil	2200V <sub>rms</sub>
between adjacent contacts	2200V <sub>rms</sub>
Initial insulation resistance	
between insulated elements	100MΩ, 500VDC

**Other Data**

Material compliance: EU RoHS/ELV, China RoHS, REACH, Halogen content refer to the Product Compliance Support Center at [www.te.com/customersupport/rohssupportcenter](http://www.te.com/customersupport/rohssupportcenter).

**Ambient temperature**

DC coil	Enclosed relays, 4 pole: -45°C to 50°C
	Enclosed relays, 1-3 pole: -45°C to 70°C
	Open relays: 15°C higher maximum
AC coil	Enclosed relays, 3 and 4 pole: -45°C to +45°C
	Enclosed relays, 1 and 2 pole: -45°C to +55°C
	Open relays: 15°C higher maximum

**Maximum allowable ambient temperature vs voltage (KUP enclosed)**



**Dimensions**

**KU bracket type**

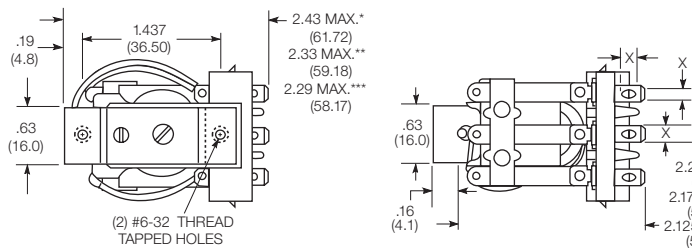

**KU stud type**

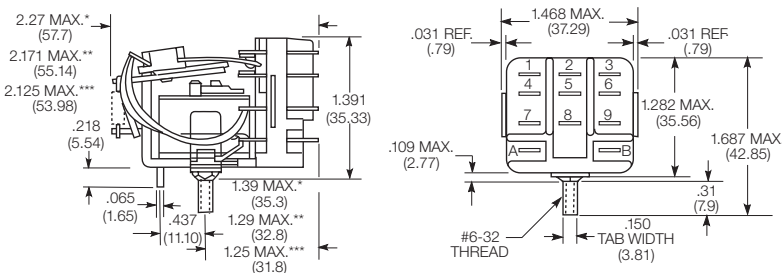

**Seated Heights For KU (open) Relays**

- 1.391" (35.33mm) for #6-32 stud with .218" (5.54mm) locating tab.
- 1.52" (38.6mm) for bracket with 2-#6 32 tapped holes.
- 1.282" (32.56mm) for #6-32 tapped core with .125" (3.18mm) or .218" (5.54mm) locating tab.
- 2.046" (51.97mm) for relay with printed circuit terminals.

STUD TYPE also available with .125" (3.18mm) tab, as well as without stud and locating tab. Models without stud have core tapped #6-32 THREAD, .25" (6.4mm) minimum depth.

- \*Dimensions with .250" (6.35mm) terminals.
- \*\* Dimensions with .110" (2.79mm) or .205" (5.21mm) terminals.
- \*\*\* Dimensions with .187" (4.75mm) terminals.

**Relay front diagrams**

**Models with 6.35mm (.250) QC terminals**

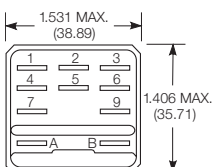

**1-3 pole models with all other terminals**

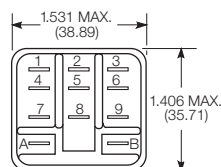

**4 pole models**



**Other Data** (continued)

Category of environmental protection	
IEC 61810	RT0 - open relay; RTI - dust protected
Terminal type	
	Quick connects (QC), .187, .205 or .250; PCB-THT
Terminal retention, push force	
QC .205	17 lbs for 3s
QC .187, QC .250, PCB	25 lbs for 3s
Weight	
	85g
Packaging/unit	
	tray/25 pcs., box/150pcs.

**Accessories**

For details see datasheet      Sockets and Accessories, KUP Relays

**Product Code Description**

27E893	DIN socket (use 20C318 clip)
27E121	Track mount socket (use 20C314 clips)
27E043	Chassis mount/solder eyelet socket (use 20C254 clip)
27E046	Chassis mount/PCB socket (use 20C254 clip)
27E067	Chassis mount/quick connect socket (use 20C254 clip)
27E396	Snap-in/quick connect socket (use 20C254 clip)

**KUP Series Panel Plug-in Relay (Continued)**

**Dimensions (continued)**

KUP plain case

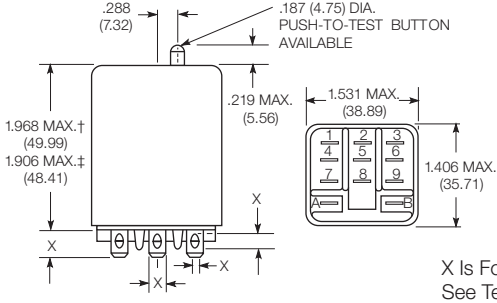

X Is For Terminal Dimensions.  
See Terminal Drawings.

KUP core / stud mount case

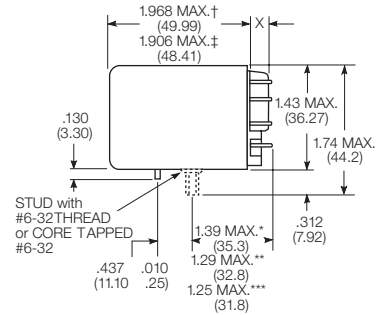

KUP top flange case

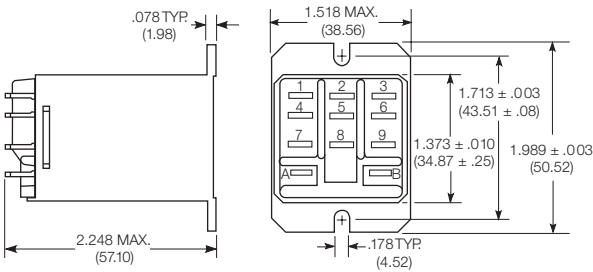

† Dimensions with .250" (6.35mm) terminals.  
‡ Dimensions with .187" (4.75mm and .205" 5.21mm) terminals.

\* Dimensions with .250" (6.35mm) terminals.  
\*\* Dimensions with .110" (2.79mm) or .205" (5.21mm) terminals.  
\*\*\* Dimensions with .187" (4.75mm) terminals.

KUP bracket mount case

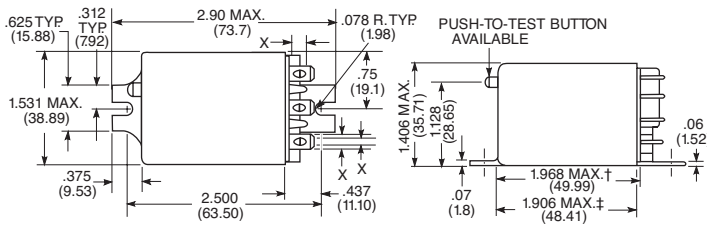

KUP stud on end case

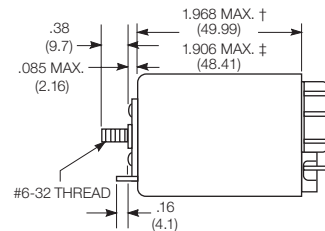

**Terminal dimensions**

4.75mm (.187) quick connect



5.21mm (.205) quick connect



1.19mm (.047) printed circuit



6.35mm (.250) quick connect

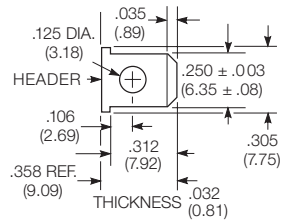

**Terminal assignment**

1 Form X



1 Form C  
1 Form A (delete 2)

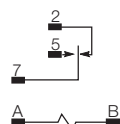

2 Form C  
2 Form A (delete 1 & 3)

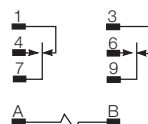

3 Form C  
3 Form A (delete 1, 2 & 3)

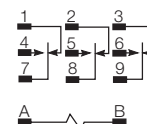

4 Form C

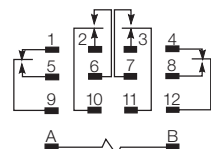

**KUP Series Panel Plug-in Relay** (Continued)

**PCB layout**

Bottom view on solder pins

1 form X version



3 pole version  
(Omit unnecessary holes for form A and 2 pole types)



4 pole version



**Product code structure**

Typical product code **KUP -14 A 1 5 -120**

Type	KUP Enclosed relay	
<b>KU</b> Open style relay		
<b>Contact arrangement</b>		
<b>1</b> 1 form A (1 NO)	<b>3</b> 1 form X (1 NO-DM)	<b>5</b> 1 form C (1 CO)
<b>7</b> 2 form A (2 NO)	<b>11</b> 2 form C (2 CO)	<b>12</b> 3 form A (3 NO)
<b>14</b> 3 form C (3 CO)	<b>17</b> 4 form C (4 CO)	
<b>Coil Input</b>		
<b>A</b> AC, 50/60Hz	<b>D</b> DC	

**Mounting and options**

**KU**

- 1** #6-32 mounting stud, 5.54mm (.218in) locating tab
- 3** #6-32 tapped core, 3.18mm (.125in) locating tab
- 4** #6-32 tapped core, 5.54mm (.218in) locating tab
- 5** #6-32 tapped core, no locating tab

**KUP**

- 1** Socket mount (plain) case
- 2** Socket mount (plain) case with push-to-test button 1)
- 3** Socket mount (plain) case with indicator lamp 2)
- 4** Socket mount (plain) case with indicator lamp and push-to-test button 1) 2)
- 5** Bracket mount case
- A** Plain case with #6-32 stud and locating tab
- E** Plain case with #6-32 tapped core and locating tab
- T** Top flange case 1)

1) Not available with four pole models (Contact arrangement 17).

2) Indicator lamps are available on models with the following coils: 6-24VAC and VDC, 110VDC and 120-240VAC. Only models with 120-240VAC coils are UL recognized.

**Terminal and contact material**

**1 and 2 pole models**

- |  |   |
|--|---|
| <b>1</b> 4.75mm (.187in) quick connect/solder; Ag, 5A        | <b>3</b> 1.19mm (.047in) PCB; Ag, 5A                      |
| <b>5</b> 4.75mm (.187in) quick connect/solder; AgCdO, 10A    | <b>7</b> 1.19mm (.047in) PCB; AgCdO, 10A                  |
| <b>J</b> 6.35mm (.250in) quick connect/solder; Ag, 5A        | <b>K</b> 6.35mm (.250in) quick connect/solder; AgCdO, 10A |
| <b>P</b> 4.75mm (.187in) quick connect/solder; AgSnOInO, 10A | <b>S</b> 1.19mm (.047in) PCB, AgSnOInO; 10A               |
| <b>W</b> 6.35mm (.250in) quick connect/solder; AgSnOInO, 10A |   |

**3 pole models**

- |  |   |
|--|---|
| <b>1</b> 4.75mm (.187in) quick connect/solder; Ag, 5A        | <b>3</b> 1.19mm (.047in) PCB; Ag, 5A        |
| <b>5</b> 4.75mm (.187in) quick connect/solder; AgCdO, 10A    | <b>7</b> 1.19mm (.047in) PCB; AgCdO, 10A    |
| <b>P</b> 4.75mm (.187in) quick connect/solder; AgSnOInO, 10A | <b>S</b> 1.19mm (.047in) PCB, AgSnOInO; 10A |

**4 pole models**

- |   |  |
|---|--|
| <b>1</b> 4.75mm (.187in) quick connect/solder; Ag, 5A 3)        | <b>3</b> 1.19mm (.047in) PCB; Ag, 5A                         |
| <b>4</b> 2.79mm (.110in) quick connect/solder; Ag, 5A           | <b>5</b> 4.75mm (.187in) quick connect/solder; AgCdO, 10A 3) |
| <b>7</b> 1.19mm (.047in) PCB; AgCdO, 10A                        | <b>9</b> 2.79mm (.110in) quick connect/solder; AgCdO, 10A    |
| <b>P</b> 4.75mm (.187in) quick connect/solder; AgSnOInO, 10A 3) | <b>S</b> 1.19mm (.047in) PCB, AgSnOInO; 10A                  |
| <b>U</b> 2.79mm (.110in) quick connect/solder; AgSnOInO, 10A 2) |  |

3) 4 pole KUP with 4.75mm (.187in) terminals will not plug into sockets. Must use 2.79mm (.110) terminals for socket mounting.

**Au flashed contact option**

- Leave Blank** No Au flashing on contacts
- F** Optional Au flashing on contacts

**Coil voltage**

Coil code: please refer to coil versions table

**KUP Series Panel Plug-in Relay** (Continued)

Product Code	Arrangement	Material	Coil	Terminals	Mounting	Part Number	
KUP-5A15-24	1 form C, 1 CO	AgCdO	24VAC	4.75mm (.187in) QC	Socket mount, plain case	6-1393118-0	
KUP-5A15-120			120VAC				5-1393119-9
KUP-5A15-240			240VAC			6-1393118-1	
KUP-5A55-120			120VAC		Bracket mount case	6-1393118-3	
KUP-5D15-12			12VDC			Socket mount, plain case	6-1393118-6
KUP-5D15-24			24VDC			6-1393118-7	
KUP-5D55-12			12VDC		Bracket mount case	7-1393118-0	
KUP-5D55-24			24VDC			7-1393118-1	
KUP-11A11-120	2 form C, 2 CO	Ag	120VAC		4.75mm (.187in) QC	Socket mount, plain case	1-1393117-7
KUP-11A15-12		AgCdO	12VDC				
KUP-11A15-24			24VAC				2-1393117-1
KUP-11A15-120			120VAC				1-1393117-9
KUP-11A15-240			240VAC				2-1393117-2
KUP-11A35-120			120VAC			Socket mount case w/ indicator lamp	2-1393117-5
KUP-11A55-24			24VAC	Bracket mount case			3-1393117-0
KUP-11A55-120			120VAC			2-1393117-9	
KUP-11AT5-120				Top flange case		1-1393117-4	
KUP-11D11-24		Ag	24VDC			Socket mount, plain case	4-1393117-2
KUP-11D15-5		AgCdO	5VDC			4-1393117-8	
KUP-11D15-12			12VDC			4-1393117-4	
KUP-11D15-24			24VDC			4-1393117-5	
KUP-11D15-36			36VDC			4-1393117-6	
KUP-11D15-110			110VDC		4-1393117-3		
KUP-11D35-24			24VDC	Socket mount case w/ indicator lamp	5-1393117-3		
KUP-11D55-6			6VDC		Bracket mount case	6-1393117-0	
KUP-11D55-12			12VDC		5-1393117-6		
KUP-11D55-24			24VDC		5-1393117-8		
KUP-11D55-48			48VDC		5-1393117-9		
KUP-11D55-110			110VDC		5-1393117-5		
KUP-14A11-120	3 form C, 3 CO	Ag	120VAC	4.75mm (.187in) QC	Socket mount, plain case	7-1393117-3	
KUP-14A15-12		AgCdO	12VAC				7-1393117-7
KUP-14A15-24			24VAC			7-1393117-9	
KUP-14A15-120			120VAC			7-1393117-8	
KUP-14A15-240			240VAC			8-1393117-0	
KUP-14A25-120			120VAC		Socket mount w/ test button	8-1393117-3	
KUP-14A35-120						Socket mount w/ indicator lamp	8-1393117-7
KUP-14A35-240			240VAC			8-1393117-9	
KUP-14A35F-120		AgCdO w/ Au flash	120VAC			9-1393117-0	
KUP-14A45-120		AgCdO			Socket mount w/ test button, indicator lamp	9-1393117-4	
KUP-14A55-24			24VAC			Bracket mount case	1393118-2
KUP-14A55-120			120VAC			9-1393117-9	
KUP-14A55-240			240VAC			1393118-3	
KUP-14D11-24		Ag	24VDC		4.75mm (.187in) QC	Socket mount, plain case	1-1393118-0
KUP-14D15-6		AgCdO	6VDC				
KUP-14D15-12			12VDC				1-1393118-3
KUP-14D15-24			24VDC				1-1393118-4
KUP-14D15-48			48VDC				1-1393118-7
KUP-14D15-110			110VDC				1-1393118-2
KUP-14D25-24			24VDC			Socket mount w/ test button	2-1393118-3
KUP-14D35-24							Socket mount w/ indicator lamp
KUP-14D35-110			110VDC				2-1393118-6
KUP-14D35F-110		AgCdO w/ Au flash					2-1393118-9
KUP-14D45-110		AgCdO				Socket mount w/ test button, indicator lamp	3-1393118-1
KUP-14D55-12			12VDC				Bracket mount case
KUP-14D55-24			24VDC				3-1393118-8
KUP-17A19-120	4 form C, 4 CO		120VAC			2.79mm (.110in) QC	Socket mount, plain case
KUP-17A55-24			24VAC		Bracket mount case		
KUP-17D19-24			24VDC		Socket mount, plain case		5-1393118-0
KUP-17D55-24			24VDC				Bracket mount case



Компания «ЭлектроПласт» предлагает заключение долгосрочных отношений при поставках импортных электронных компонентов на взаимовыгодных условиях!

Наши преимущества:

- Оперативные поставки широкого спектра электронных компонентов отечественного и импортного производства напрямую от производителей и с крупнейших мировых складов;
- Поставка более 17-ти миллионов наименований электронных компонентов;
- Поставка сложных, дефицитных, либо снятых с производства позиций;
- Оперативные сроки поставки под заказ (от 5 рабочих дней);
- Экспресс доставка в любую точку России;
- Техническая поддержка проекта, помощь в подборе аналогов, поставка прототипов;
- Система менеджмента качества сертифицирована по Международному стандарту ISO 9001;
- Лицензия ФСБ на осуществление работ с использованием сведений, составляющих государственную тайну;
- Поставка специализированных компонентов (Xilinx, Altera, Analog Devices, Intersil, Interpoint, Microsemi, Aeroflex, Peregrine, Syfer, Eurofarad, Texas Instrument, Miteq, Cobham, E2V, MA-COM, Hittite, Mini-Circuits, General Dynamics и др.);

Помимо этого, одним из направлений компании «ЭлектроПласт» является направление «Источники питания». Мы предлагаем Вам помощь Конструкторского отдела:

- Подбор оптимального решения, техническое обоснование при выборе компонента;
- Подбор аналогов;
- Консультации по применению компонента;
- Поставка образцов и прототипов;
- Техническая поддержка проекта;
- Защита от снятия компонента с производства.



#### Как с нами связаться

**Телефон:** 8 (812) 309 58 32 (многоканальный)

**Факс:** 8 (812) 320-02-42

**Электронная почта:** [org@eplast1.ru](mailto:org@eplast1.ru)

**Адрес:** 198099, г. Санкт-Петербург, ул. Калинина, дом 2, корпус 4, литера А.