

LM4040

Precision micropower shunt voltage references

Description

The LM4040 is a family of bandgap circuits designed to achieve precision micro-power voltage references of 2.5V, 3.0V and 5.0V. The devices are available in 0.2% B-grade, 0.5% C-grade and 1% D-grade initial tolerances.

They are available in small outline SOT23 and SC75 surface mount package which are ideal for applications where space saving is important.

Excellent performance is maintained over the 60µA to 15mA operating current range with a typical temperature coefficient of only 20ppm/°C. The device has been designed to be highly tolerant of capacitive loads so maintaining excellent stability.

This device offers a pin for pin compatible alternative to the LM4040 voltage reference. The LM4040 is also available with AEC-Q100 approval; see LM4040Q datasheet

Features

- Small packages: SOT23 & SC75
- No output capacitor required
- Output voltage tolerance
 - LM4040B ±0.2% at 25°C
 - LM4040C ±0.5% at 25°C
 - LM4040D ±1% at 25°C
- Low output noise
(10Hz to 10kHz)..... 45µV_{RMS}
- Wide operating current range 60µA to 15mA
- Extended temperature range -40°C to +125°C
- Low temperature coefficient 100 ppm/°C (max)

Applications

- Battery powered equipment
- Precision power supplies
- Portable instrumentation
- Portable communications devices
- Notebook and palmtop computers
- Data acquisition systems

Pinout information

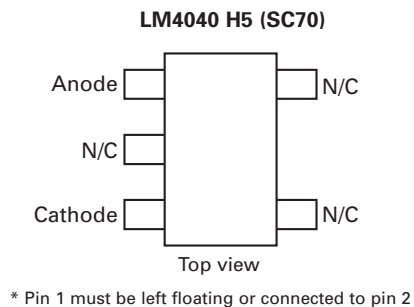
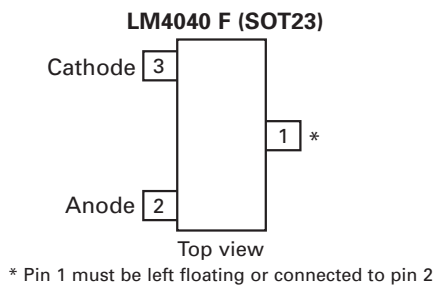

Ordering information

25°C Tol	Voltage (V)	Order Code	Package	Part mark	Status	Reel Size	Tape Width	Quantity per reel
0.2%	2.5	LM4040B25FTA	SOT23	R2B	Active	7", 180mm	8mm	3000
		LM4040B25H5TA	SC75	R2B	Active	7", 180mm	8mm	3000
	3.0	LM4040B30FTA	SOT23	R3B	Active	7", 180mm	8mm	3000
		LM4040B30H5TA	SC75	R3B	Active	7", 180mm	8mm	3000
	5.0	LM4040B50FTA	SOT23	R5B	Active	7", 180mm	8mm	3000
		LM4040B50H5TA	SC75	R5B	Active	7", 180mm	8mm	3000
0.5%	2.5	LM4040C25FTA	SOT23	R2C	Active	7", 180mm	8mm	3000
		LM4040C25H5TA	SC75	R2C	Active	7", 180mm	8mm	3000
	3.0	LM4040C30FTA	SOT23	R3C	Active	7", 180mm	8mm	3000
		LM4040C30H5TA	SC75	R3C	Active	7", 180mm	8mm	3000
	5.0	LM4040C50FTA	SOT23	R5C	Active	7", 180mm	8mm	3000
		LM4040C50H5TA	SC75	R5C	Active	7", 180mm	8mm	3000
1%	2.5	LM4040D25FTA	SOT23	R2D	Active	7", 180mm	8mm	3000
		LM4040D25H5TA	SC75	R2D	Active	7", 180mm	8mm	3000
	3.0	LM4040D30FTA	SOT23	R3D	Active	7", 180mm	8mm	3000
		LM4040D30H5TA	SC75	R3D	Active	7", 180mm	8mm	3000
	5.0	LM4040D50FTA	SOT23	R5D	Active	7", 180mm	8mm	3000
		LM4040D50H5TA	SC75	R5D	Active	7", 180mm	8mm	3000

Absolute maximum ratings

Continuous reverse current (I_R)	20mA
Continuous forward current (I_{REF})	10mA
Operating junction temperature	-40°C to 150°C
Storage temperature	-55°C to 150°C

Operation above the absolute maximum rating may cause device failure. Operation at the absolute maximum ratings, for extended periods, may reduce device reliability.

Unless otherwise stated voltages specified are relative to the ANODE pin.

Package thermal data

Package	θ_{JA}	P_{DIS} $T_{amb} = 25^\circ\text{C}, T_J = 150^\circ\text{C}$
SOT23	380°C/W	330mW
SC75	380°C/W	330mW

Recommended operating conditions

	Min.	Max.	Units
Reverse current	0.06	15	mA
Operating ambient temperature range	-40	125	°C

LM4040 - 2.5

Electrical characteristics

Over recommended operating conditions, $T_{amb} = 25^{\circ}\text{C}$, unless otherwise stated.

Symbol	Parameter	Conditions		Typ.	LM404 B limits	LM4040 C limits	LM4040 D limits	Units
			T_{amb}					
V_{REF}	Reverse breakdown voltage	$I_R = 100\mu\text{A}$	25°C	2.5				V
	Reverse breakdown voltage tolerance	$I_R = 100\mu\text{A}$	25°C		± 5	± 12	± 25	mV
			-40 to 85°C		± 21	± 29	± 49	
-40 to 125°C		± 30	± 38	± 63				
I_{RMIN}	Minimum operating current		25°C	45	60	60	65	μA
			-40 to 85°C		65	65	70	
			-40 to 125°C		68	68	73	
$\Delta V_R/\Delta T$	Average reverse breakdown voltage temperature coefficient	$I_R = 10\text{mA}$	-40 to 125°C	± 20				ppm/ $^{\circ}\text{C}$
		$I_R = 1\text{mA}$,		± 15	100	± 100	± 150	
		$I_R = 100\mu\text{A}$		± 15				
$\Delta V_R/\Delta I_R$	Reverse breakdown change with current	$I_{RMIN} < I_R < 1\text{mA}$	25°C	0.3	0.8	0.8	1.0	mV
			-40 to 85°C		1.0	1.0	1.2	
			-40 to 125°C		1.0	1.0	1.2	
		$1\text{mA} < I_R < 15\text{mA}$	25°C	2.5	6.0	6.0	8.0	
			-40 to 85°C		8.0	8.0	10.0	
			-40 to 125°C		8.0	8.0	10.0	
Z_R	Dynamic output impedance	$I_R = 1\text{mA}$, $f = 120\text{Hz}$ $I_{AC} = 0.1I_R$		0.3	0.8	0.9	1.1	Ω
e_n	Noise voltage	$I_R = 100\mu\text{A}$ $10\text{Hz} < f < 10\text{kHz}$		35				μV_{RMS}
ΔV_R	Long term stability (non cumulative)	$t = 1000\text{Hrs}$ $I_R = 100\mu\text{A}$		120				ppm
V_{HYST}	Thermal hysteresis	$\Delta T = -40^{\circ}\text{C}$ to $+125^{\circ}\text{C}$		0.08				%

LM4040 - 3.0

Electrical characteristics

Over recommended operating conditions, $T_{amb} = 25^{\circ}\text{C}$, unless otherwise stated

Symbol	Parameter	Conditions		Typ.	LM404 B limits	LM4040 C limits	LM4040 D limits	Units
			T_{amb}					
V_{REF}	Reverse breakdown voltage	$I_R = 100\mu\text{A}$	25°C	3.0				V
	Reverse breakdown voltage tolerance	$I_R = 100\mu\text{A}$	25°C		± 6	± 15	± 30	mV
			-40 to 85°C		± 26	± 34	± 59	
-40 to 125°C	TBD	± 45	± 75					
I_{RMIN}	Minimum operating current		25°C	47	62	62	67	μA
			-40 to 85°C	67	67	72		
			-40 to 125°C	70	70	75		
$\Delta V_R/\Delta T$	Average reverse breakdown voltage temperature coefficient	$I_R = 10\text{mA}$	-40 to 125°C	± 20				ppm/ $^{\circ}\text{C}$
		$I_R = 1\text{mA}$,		± 15	100	± 100	± 150	
		$I_R = 100\mu\text{A}$		± 15				
$\Delta V_R/\Delta I_R$	Reverse breakdown change with current	$I_{RMIN} < I_R < 1\text{mA}$	25°C	0.4	0.8	0.8	1.1	mV
			-40 to 85°C		1.1	1.1	1.3	
			-40 to 125°C		1.1	1.1	1.3	
		$1\text{mA} < I_R < 15\text{mA}$	25°C	2.7	6.0	6.0	8.0	
			-40 to 85°C		9.0	9.0	11.0	
			-40 to 125°C		9.0	9.0	11.0	
Z_R	Dynamic output impedance	$I_R = 1\text{mA}$, $f = 120\text{Hz}$ $I_{AC} = 0.1I_R$		0.4	0.9	0.9	1.2	Ω
e_n	Noise voltage	$I_R = 100\mu\text{A}$ $10\text{Hz} < f < 10\text{kHz}$		35				μV_{RMS}
ΔV_R	Long term stability (non cumulative)	$t = 1000\text{Hrs}$ $I_R = 100\mu\text{A}$		120				ppm
V_{HYST}	Thermal hysteresis	$\Delta T = -40^{\circ}\text{C}$ to $+125^{\circ}\text{C}$		0.08				%

LM4040 - 5.0

Electrical characteristics

Over recommended operating conditions, $T_{amb} = 25^{\circ}\text{C}$, unless otherwise stated.

Symbol	Parameter	Conditions		Typ.	LM404 B limits	LM4040 C limits	LM4040 D limits	Units
			T_{amb}					
V_{REF}	Reverse breakdown voltage	$I_R = 100\mu\text{A}$	25°C	5.0	5.0			V
	Reverse breakdown voltage tolerance	$I_R = 100\mu\text{A}$	25°C		± 10	± 25	± 50	mV
			-40 to 85°C		± 43	± 58	± 99	
			-40 to 125°C		± 60	± 75	± 125	
I_{RMIN}	Minimum operating current		25°C	54	74	74	79	μA
			-40 to 85°C		80	80	85	
			-40 to 125°C		83	83	88	
$\Delta V_R/\Delta T$	Average reverse breakdown voltage temperature coefficient	$I_R = 10\text{mA}$	-40 to 125°C	± 30				ppm/ $^{\circ}\text{C}$
		$I_R = 1\text{mA}$,		± 20	100	± 100	± 150	
		$I_R = 100\mu\text{A}$		± 20				
$\Delta V_R/\Delta I_R$	Reverse breakdown change with current	$I_{RMIN} < I_R < 1\text{mA}$	25°C	0.5	1.0	1.0	1.3	mV
			-40 to 85°C		1.4	1.4	1.8	
			-40 to 125°C		1.4	1.4	1.8	
		$1\text{mA} < I_R < 15\text{mA}$	25°C	3.5	8.0	8.0	10.0	
			-40 to 85°C		12.0	12.0	15.0	
			-40 to 125°C		12.0	12.0	15.0	
Z_R	Dynamic output impedance	$I_R = 1\text{mA}$, $f = 120\text{Hz}$ $I_{AC} = 0.1I_R$		0.5	1.1	1.1	1.5	Ω
e_n	Noise voltage	$I_R = 100\mu\text{A}$ $10\text{Hz} < f < 10\text{kHz}$		80				μV_{RMS}
ΔV_R	Long term stability (non cumulative)	$t = 1000\text{Hrs}$ $I_R = 100\mu\text{A}$		120				ppm
V_{HYST}	Thermal hysteresis	$\Delta T = -40^{\circ}\text{C}$ to $+125^{\circ}\text{C}$		0.08				%

LM4040-2.5 Typical Characteristics

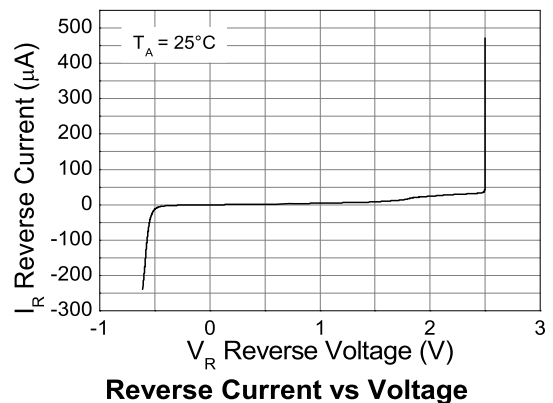
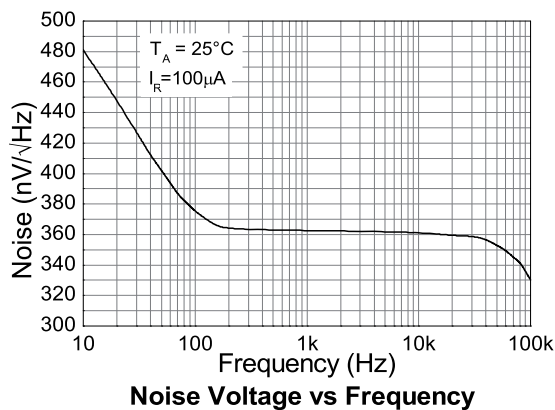
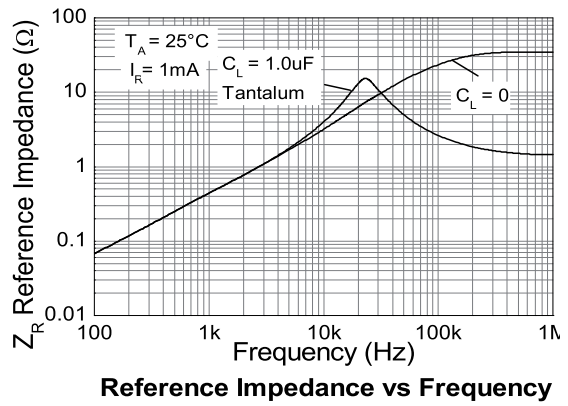
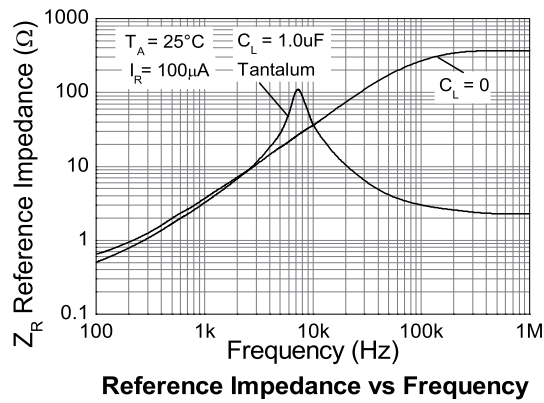
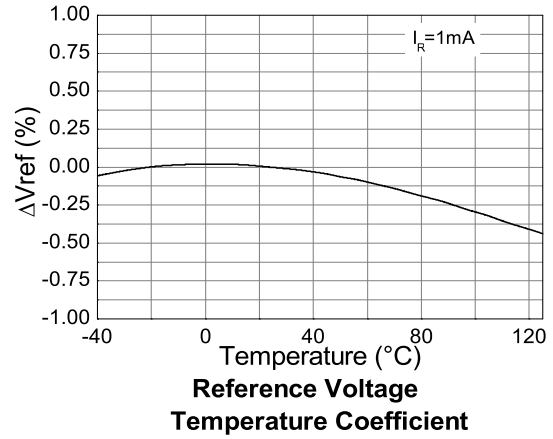
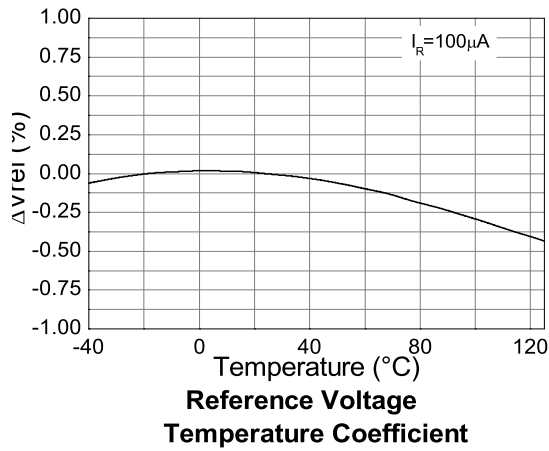

LM4040-3.0 Typical characteristics

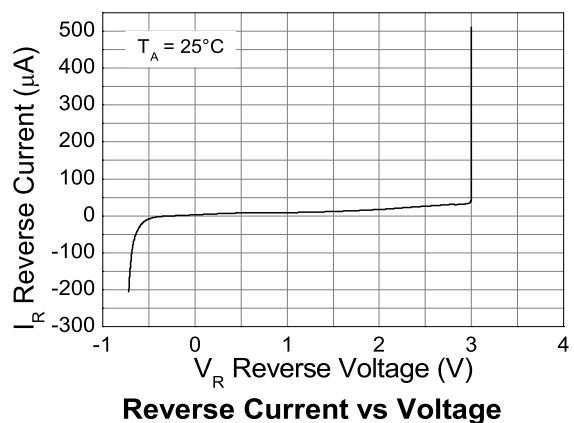
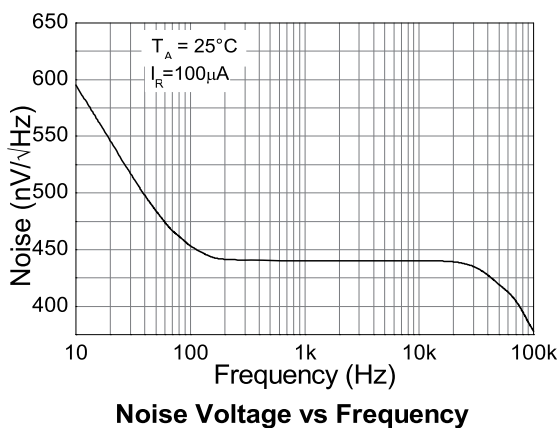
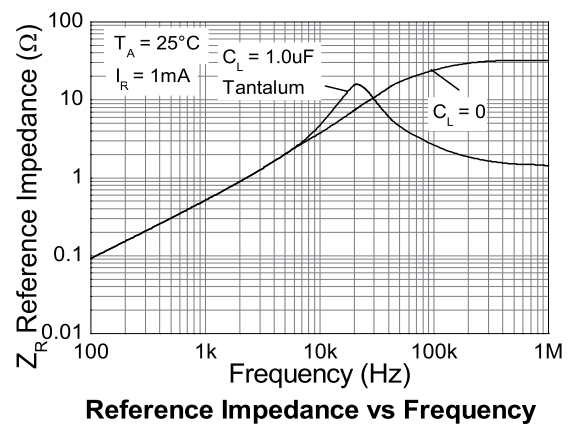
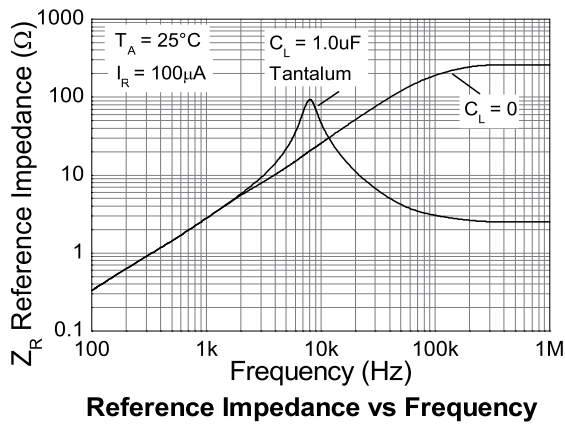
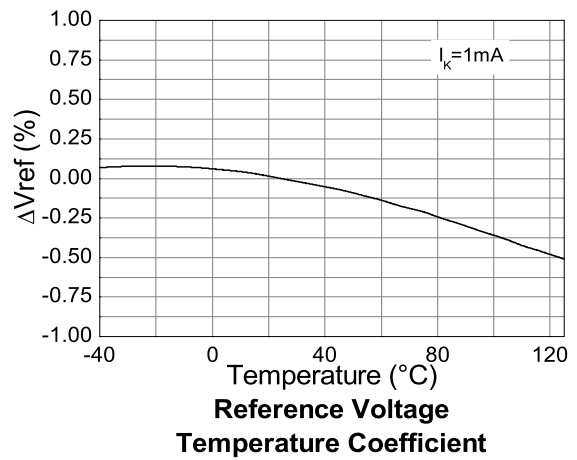
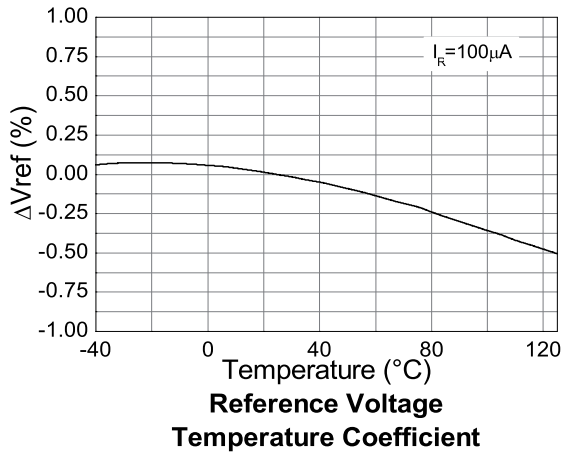

LM4040-5.0 Typical characteristics

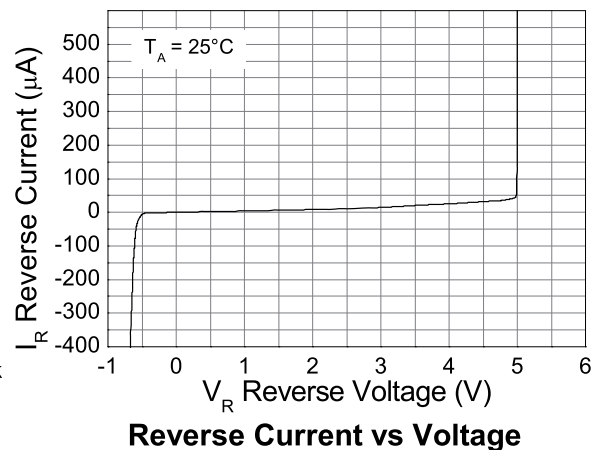
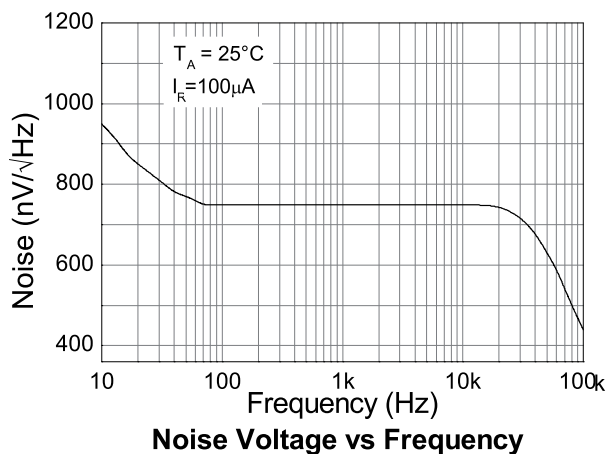
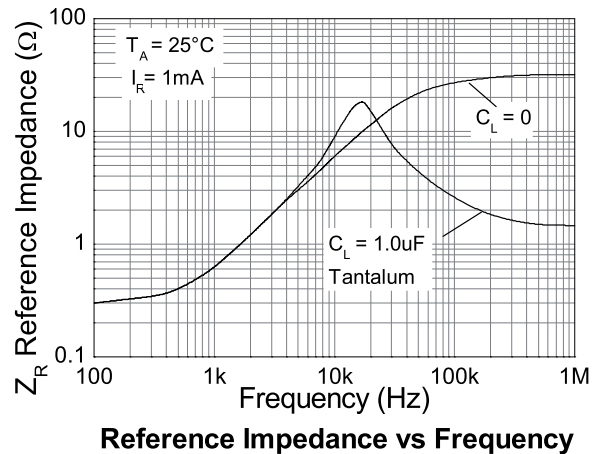
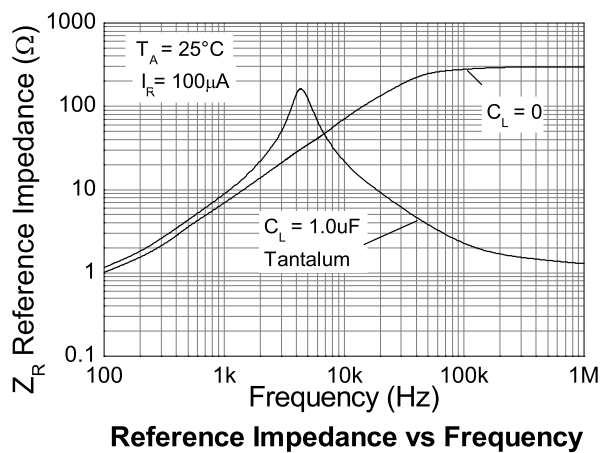
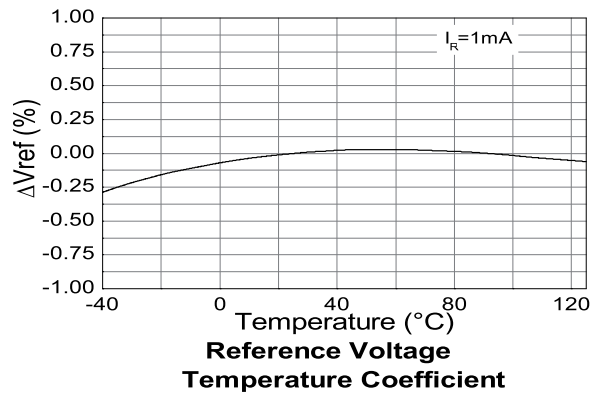
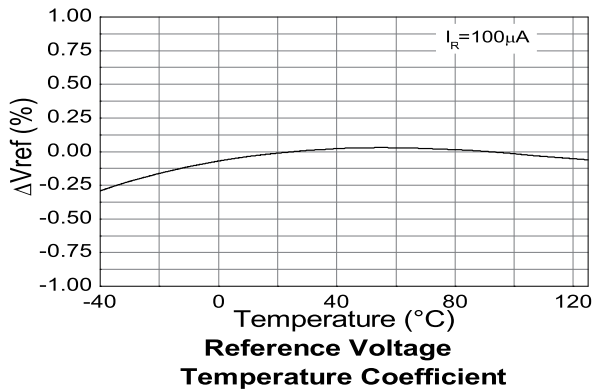

LM4040 - 2.5, 3.0 and 5.0 Start up characteristics

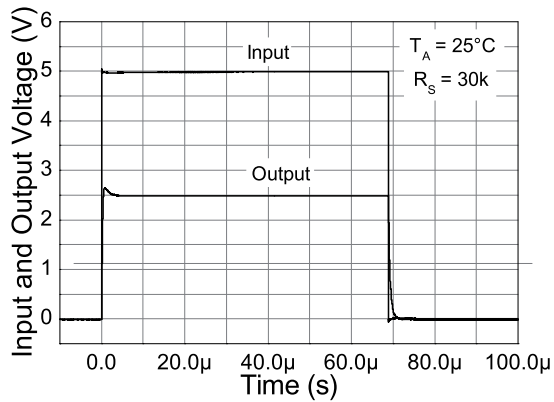

Long Pulse Response

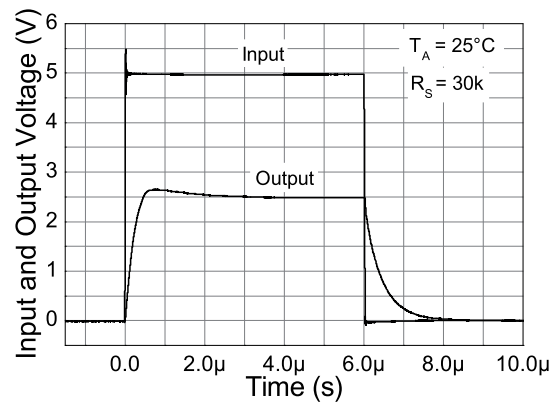

Short Pulse Response

LM4040-3.0

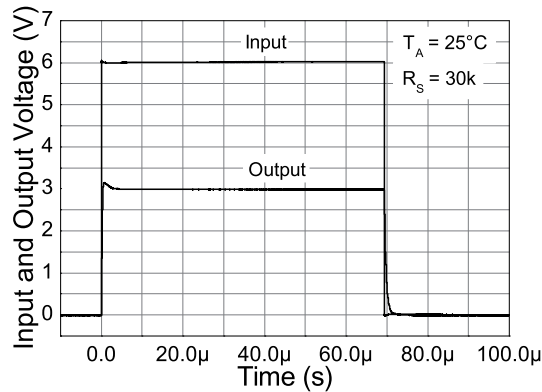

Long Pulse Response

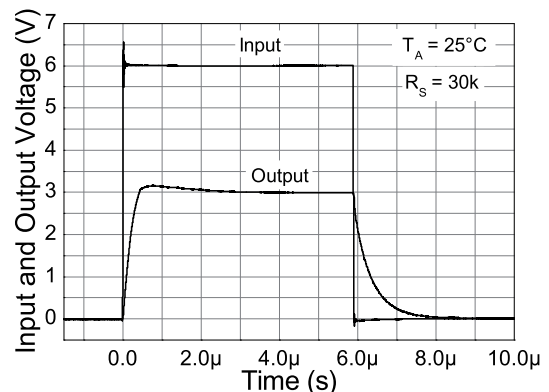

Short Pulse Response

LM4040-5.0

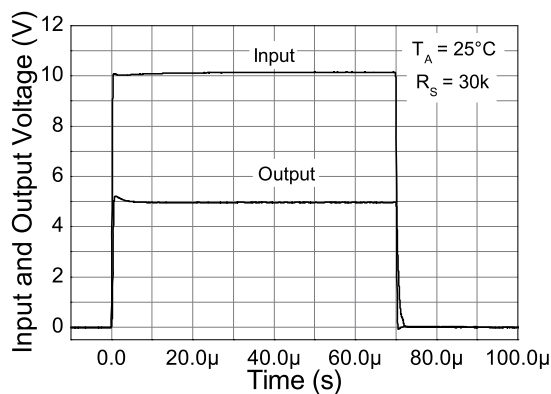

Long Pulse Response

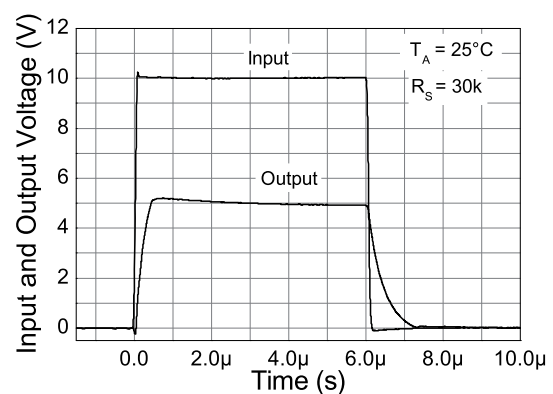

Short Pulse Response

Application information

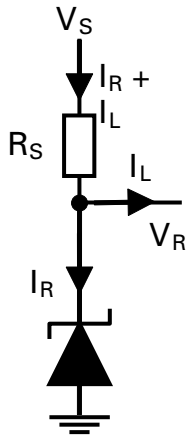

In a conventional shunt regulator application, an external series resistor (R_S) is connected between the supply voltage, V_S , and the LM4040

R_S determines the current that flows through the load (I_L) and the LM4040 (I_R). Since load current and supply voltage may vary, R_S should be small enough to supply at least the minimum acceptable I_R to the LM4040 even when the supply voltage is at its minimum and the load current is at its maximum value. When the supply voltage is at its maximum and I_L is at its minimum, R_S should be large enough so that the current flowing through the LM4040 is less than 15 mA.

R_S is determined by the supply voltage, (V_S), the load and operating current, (I_L and I_R), and the LM4040's reverse breakdown voltage, V_R .

$$R_S = \frac{V_S - V_R}{I_L + I_R}$$

Printed circuit board layout considerations

LM4040s in the SOT23 package have the die attached to pin 1, which results in an electrical contact between pin 2 and pin 3. Therefore, pin 1 of the SOT-23 package must be left floating or connected to pin 2.

LM4040s in the SC75 package have the die attached to pin 2, which results in an electrical contact between pin 2 and pin 1. Therefore, pin 2 must be left floating or connected to pin 1.

Package outline - SOT23

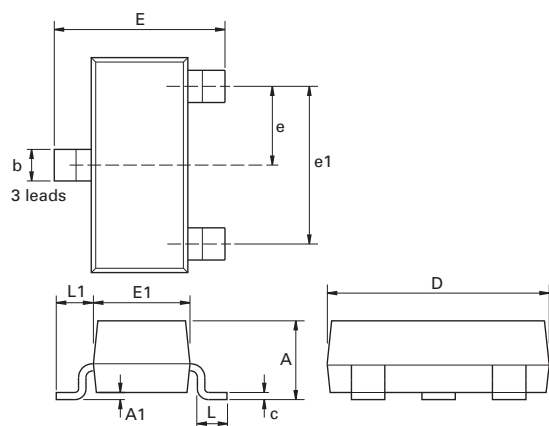

Dim.	Millimeters		Inches		Dim.	Millimeters		Inches	
	Min.	Max.	Min.	Max.		Min.	Max.	Max.	Max.
A	-	1.12	-	0.044	e1	1.90 NOM		0.075 NOM	
A1	0.01	0.10	0.0004	0.004	E	2.10	2.64	0.083	0.104
b	0.30	0.50	0.012	0.020	E1	1.20	1.40	0.047	0.055
C	0.085	0.120	0.003	0.008	L	0.25	0.62	0.018	0.024
D	2.80	3.04	0.110	0.120	L1	0.45	0.62	0.018	0.024
e	0.95 NOM		0.0375 NOM		-	-	-	-	-

Note: Controlling dimensions are in millimeters. Approximate dimensions are provided in inches

Package outline SC-70-5

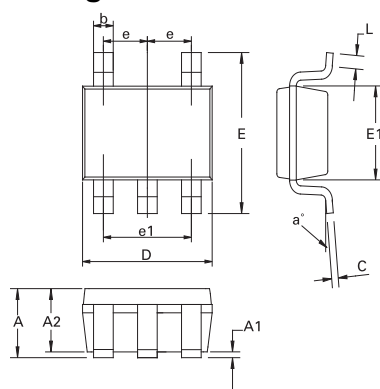

Dim.	Millimeters		Inches		Dim.	Millimeters		Inches	
	Min.	Max.	Min.	Max.		Min.	Max.	Max.	Max.
A	0.80	1.10	0.0315	0.0433	E	2.10 BSC		0.0826 BSC	
A1	-	0.10	-	0.0039	E1	1.25 BSC		0.0492 BSC	
A2	0.80	1.00	0.0315	0.0394	e	0.65 BSC		0.0255 BSC	
b	0.15	0.30	0.006	0.0118	e1	1.30 BSC		0.0511 BSC	
C	0.08	0.25	0.0031	0.0098	L	0.26	0.46	0.0102	0.0181
D	2.00 BSC		0.0787 BSC		a°	0	8	0	8

Definitions

Product change

Diodes Incorporated reserves the right to alter, without notice, specifications, design, price or conditions of supply of any product or service. Customers are solely responsible for obtaining the latest relevant information before placing orders.

Applications disclaimer

The circuits in this design/application note are offered as design ideas. It is the responsibility of the user to ensure that the circuit is fit for the user's application and meets with the user's requirements. No representation or warranty is given and no liability whatsoever is assumed by Diodes Inc. with respect to the accuracy or use of such information, or infringement of patents or other intellectual property rights arising from such use or otherwise. Diodes Inc. does not assume any legal responsibility or will not be held legally liable (whether in contract, tort (including negligence), breach of statutory duty, restriction or otherwise) for any damages, loss of profit, business, contract, opportunity or consequential loss in the use of these circuit applications, under any circumstances.

Life support

Diodes Zetex products are specifically not authorized for use as critical components in life support devices or systems without the express written approval of the Chief Executive Officer of Diodes Incorporated. As used herein:

A. Life support devices or systems are devices or systems which:

1. are intended to implant into the body

or

2. support or sustain life and whose failure to perform when properly used in accordance with instructions for use provided in the labelling can be reasonably expected to result in significant injury to the user.

B. A critical component is any component in a life support device or system whose failure to perform can be reasonably expected to cause the failure of the life support device or to affect its safety or effectiveness.

Reproduction

The product specifications contained in this publication are issued to provide outline information only which (unless agreed by the company in writing) may not be used, applied or reproduced for any purpose or form part of any order or contract or be regarded as a representation relating to the products or services concerned.

Terms and Conditions

All products are sold subjects to Diodes Zetex' terms and conditions of sale, and this disclaimer (save in the event of a conflict between the two when the terms of the contract shall prevail) according to region, supplied at the time of order acknowledgement.

For the latest information on technology, delivery terms and conditions and prices, please contact your nearest Diodes sales office or visit: www.zetex.com

Quality of product

Diodes Zetex Semiconductors Limited is an ISO 9001 and TS16949 certified semiconductor manufacturer.

To ensure quality of service and products we strongly advise the purchase of parts directly from Diodes Zetex Semiconductors Limited or one of our regionally authorized distributors. For a complete listing of authorized distributors please visit: www.zetex.com or www.diodes.com. Diodes Zetex Semiconductors does not warrant or accept any liability whatsoever in respect of any parts purchased through unauthorized sales channels.

ESD (Electrostatic discharge)

Semiconductor devices are susceptible to damage by ESD. Suitable precautions should be taken when handling and transporting devices. The possible damage to devices depends on the circumstances of the handling and transporting, and the nature of the device. The extent of damage can vary from immediate functional or parametric malfunction to degradation of function or performance in use over time. Devices suspected of being affected should be replaced.

Green compliance

Diodes Zetex Semiconductors is committed to environmental excellence in all aspects of its operations which includes meeting or exceeding regulatory requirements with respect to the use of hazardous substances. Numerous successful programs have been implemented to reduce the use of hazardous substances and/or emissions.

All Diodes Zetex components are compliant with the RoHS directive, and through this it is supporting its customers in their compliance with WEEE and ELV directives.

Product status key:

"Preview"	Future device intended for production at some point. Samples may be available
"Active"	Product status recommended for new designs
"Last time buy (LTB)"	Device will be discontinued and last time buy period and delivery is in effect
"Not recommended for new designs"	Device is still in production to support existing designs and production
"Obsolete"	Production has been discontinued

Datasheet status key:

"Draft version"	This term denotes a very early datasheet version and contains highly provisional information, which may change in any manner without notice.
"Provisional version"	This term denotes a pre-release datasheet. It provides a clear indication of anticipated performance. However, changes to the test conditions and specifications may occur, at any time and without notice.
"Issue"	This term denotes an issued datasheet containing finalized specifications. However, changes to specifications may occur, at any time and without notice.

Diodes Zetex sales offices

Europe	Americas	Asia Pacific	Corporate Headquarters
Zetex GmbH Kustermann-park Balanstraße 59 D-81541 München Germany Telephone: (49) 89 45 49 49 0 Fax: (49) 89 45 49 49 49 europe.sales@zetex.com	Zetex Inc 700 Veterans Memorial Highway Hauppauge, NY 11788 USA Telephone: (1) 631 360 2222 Fax: (1) 631 360 8222 usa.sales@zetex.com	Diodes Zetex (Asia) Ltd 3701-04 Metroplaza Tower 1 Hing Fong Road, Kwai Fong Hong Kong Telephone: (852) 26100 611 Fax: (852) 24250 494 asia.sales@zetex.com	Diodes Incorporated 15660 N. Dallas Parkway Suite 850, Dallas TX75248, USA www.diodes.com

© 2008 Published by Diodes Incorporated



Компания «ЭлектроПласт» предлагает заключение долгосрочных отношений при поставках импортных электронных компонентов на взаимовыгодных условиях!

Наши преимущества:

- Оперативные поставки широкого спектра электронных компонентов отечественного и импортного производства напрямую от производителей и с крупнейших мировых складов;
- Поставка более 17-ти миллионов наименований электронных компонентов;
- Поставка сложных, дефицитных, либо снятых с производства позиций;
- Оперативные сроки поставки под заказ (от 5 рабочих дней);
- Экспресс доставка в любую точку России;
- Техническая поддержка проекта, помощь в подборе аналогов, поставка прототипов;
- Система менеджмента качества сертифицирована по Международному стандарту ISO 9001;
- Лицензия ФСБ на осуществление работ с использованием сведений, составляющих государственную тайну;
- Поставка специализированных компонентов (Xilinx, Altera, Analog Devices, Intersil, Interpoint, Microsemi, Aeroflex, Peregrine, Syfer, Eurofarad, Texas Instrument, Miteq, Cobham, E2V, MA-COM, Hittite, Mini-Circuits, General Dynamics и др.);

Помимо этого, одним из направлений компании «ЭлектроПласт» является направление «Источники питания». Мы предлагаем Вам помощь Конструкторского отдела:

- Подбор оптимального решения, техническое обоснование при выборе компонента;
- Подбор аналогов;
- Консультации по применению компонента;
- Поставка образцов и прототипов;
- Техническая поддержка проекта;
- Защита от снятия компонента с производства.



Как с нами связаться

Телефон: 8 (812) 309 58 32 (многоканальный)

Факс: 8 (812) 320-02-42

Электронная почта: org@eplast1.ru

Адрес: 198099, г. Санкт-Петербург, ул. Калинина, дом 2, корпус 4, литера А.