

## High Temperature 175°C Dual 100MHz, Rail-to-Rail Input and Output, Ultralow 1.9nV/√Hz Noise, Low Power Op Amp

### FEATURES

- Extreme High Temperature Operation: -40°C to 175°C
- Low Noise Voltage: 1.9nV/√Hz (100kHz)
- Low Supply Current: 3mA/Amp Max
- Gain Bandwidth Product: 100MHz
- Low Distortion: -80dB at 1MHz
- Low Offset Voltage: 500µV Max
- Wide Supply Range: 2.5V to 12.6V
- Inputs and Outputs Swing Rail-to-Rail
- Common Mode Rejection Ratio 90dB Typ
- Low Noise Current: 1.1pA/√Hz
- Output Current: 30mA Min
- 8-Pin SO Package
- Available as Dice

### APPLICATIONS

- Down Hole Drilling and Instrumentation
- Heavy Industrial
- Avionics
- High Temperature Environments
- Low Noise, Low Power Signal Processing
- Active Filters
- Rail-to-Rail Buffer Amplifiers
- Driving A/D Converters
- DSL Receivers
- Battery Powered/Battery Backed Equipment

### DESCRIPTION

The LT<sup>®</sup>6203X is a dual low noise, rail-to-rail input and output unity gain stable op amp that features 1.9nV/√Hz noise voltage and draws only 2.5mA of supply current per amplifier. These amplifiers combine very low noise and supply current with a 100MHz gain bandwidth product, a 25V/µs slew rate, and are optimized for low supply signal conditioning systems.

These amplifiers maintain their performance for supplies from 2.5V to 12.6V and are specified at 3V, 5V and ±5V supplies. Harmonic distortion is less than -80dBc at 1MHz making these amplifiers suitable in low power data acquisition systems.

These devices can be used as plug-in replacements for many op amps to improve input/output range and noise performance.

The LT6203X is a member of a growing series of high temperature qualified products offered by Linear Technology<sup>®</sup>. For a complete selection of high temperature products, please consult our website, [www.linear.com](http://www.linear.com).

The LT6203X comes in an 8-pin SO package with standard dual op amp pinout. The LT6203X is also available as dice.

LT, LT, LTC, LTM, Linear Technology and the Linear logo are registered trademarks of Analog Devices, Inc. All other trademarks are the property of their respective owners.

### TYPICAL APPLICATION

#### Low Noise Differential Amplifier with Gain Adjust and Common Mode Control

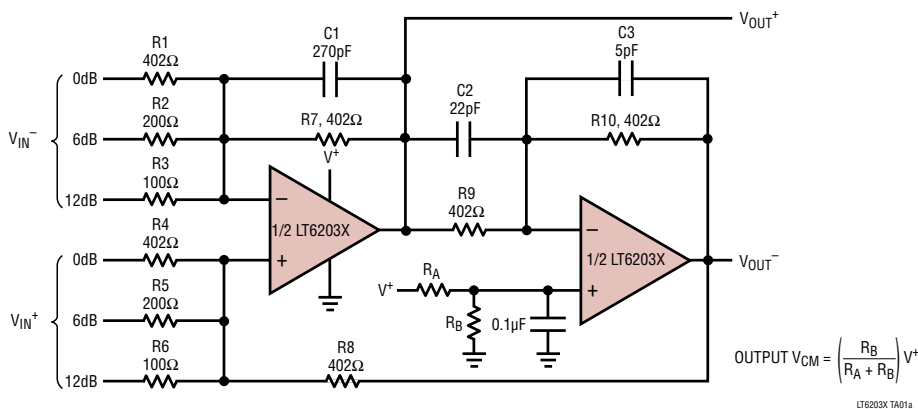

#### Low Noise Differential Amplifier Frequency Response

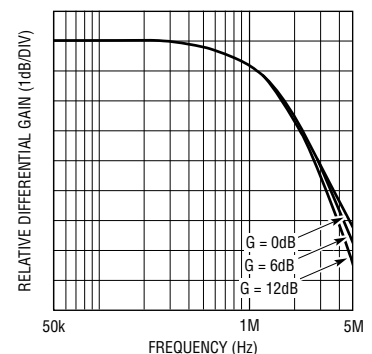

# LT6203X

## ABSOLUTE MAXIMUM RATINGS

(Note 1)

Total Supply Voltage ( $V^+$ to $V^-$ ) .....	12.6V
Input Current (Note 2) .....	$\pm 40\text{mA}$
Output Short-Circuit Duration (Note 3) .....	Thermally Limited
Operating Temperature Range (Note 4) LT6203X .....	$-40^\circ\text{C}$ to $175^\circ\text{C}$
Junction Temperature .....	$200^\circ\text{C}$
Storage Temperature Range .....	$-65^\circ\text{C}$ to $200^\circ\text{C}$
Lead Temperature (Soldering, 10 sec) .....	$300^\circ\text{C}$

## PIN CONFIGURATION

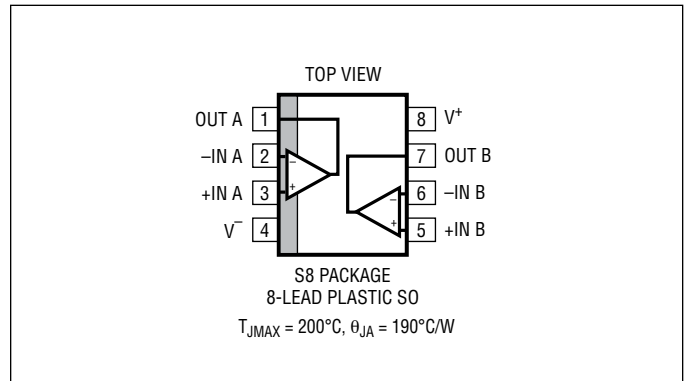

## ORDER INFORMATION

(<http://www.linear.com/product/LT6203X#orderinfo>)

LEAD FREE FINISH	TAPE AND REEL	PART MARKING	PACKAGE DESCRIPTION	SPECIFIED TEMPERATURE RANGE
LT6203XS8#PBF	LT6203XS8#TRPBF	6203X	8-Lead Plastic SO	$-40^\circ\text{C}$ to $175^\circ\text{C}$

\*The temperature grade is identified by a label on the shipping container

For more information on lead free part marking, go to: <http://www.linear.com/leadfree/>

For more information on tape and reel specifications, go to: <http://www.linear.com/tapeandreel/>. Some packages are available in 500 unit reels through designated sales channels with #TRMPBF suffix.

## ELECTRICAL CHARACTERISTICS

$T_A = 25^\circ\text{C}$ ,  $V_S = 5\text{V}, 0\text{V}$ ;  $V_S = 3\text{V}, 0\text{V}$ ;  $V_{CM} = V_{OUT} = \text{half supply}$ ,

unless otherwise noted.

SYMBOL	PARAMETER	CONDITIONS	MIN	TYP	MAX	UNITS
$V_{OS}$	Input Offset Voltage	$V_S = 5\text{V}, 0\text{V}, V_{CM} = \text{Half Supply}$		0.1	0.5	mV
		$V_S = 3\text{V}, 0\text{V}, V_{CM} = \text{Half Supply}$		0.6	1.5	mV
		$V_S = 5\text{V}, 0\text{V}, V_{CM} = V^+ \text{ to } V^-$		0.25	2.0	mV
		$V_S = 3\text{V}, 0\text{V}, V_{CM} = V^+ \text{ to } V^-$		1.0	3.5	mV
	Input Offset Voltage Match (Channel-to-Channel) (Note 5)	$V_{CM} = \text{Half Supply}$		0.15	0.8	mV
		$V_{CM} = V^- \text{ to } V^+$		0.3	1.8	mV
$I_B$	Input Bias Current	$V_{CM} = \text{Half Supply}$	-7.0	-1.3		$\mu\text{A}$
		$V_{CM} = V^+$		1.3	2.5	$\mu\text{A}$
		$V_{CM} = V^-$	-8.8	-3.3		$\mu\text{A}$
$\Delta I_B$	$I_B$ Shift	$V_{CM} = V^- \text{ to } V^+$		4.7	11.3	$\mu\text{A}$
	$I_B$ Match (Channel-to-Channel) (Note 5)			0.1	0.6	$\mu\text{A}$

**ELECTRICAL CHARACTERISTICS**  $T_A = 25^\circ\text{C}$ ,  $V_S = 5\text{V}$ ,  $0\text{V}$ ;  $V_S = 3\text{V}$ ,  $0\text{V}$ ;  $V_{\text{CM}} = V_{\text{OUT}} = \text{half supply}$ , unless otherwise noted.

SYMBOL	PARAMETER	CONDITIONS	MIN	TYP	MAX	UNITS
$I_{\text{OS}}$	Input Offset Current	$V_{\text{CM}} = \text{Half Supply}$		0.12	1	$\mu\text{A}$
		$V_{\text{CM}} = V^+$		0.07	1	$\mu\text{A}$
		$V_{\text{CM}} = V^-$		0.12	1.1	$\mu\text{A}$
	Input Noise Voltage	0.1Hz to 10Hz		800		$\text{nV}_{\text{P-P}}$
$e_n$	Input Noise Voltage Density	$f = 100\text{kHz}$ , $V_S = 5\text{V}$		2		$\text{nV}/\sqrt{\text{Hz}}$
		$f = 10\text{kHz}$ , $V_S = 5\text{V}$		2.9	4.5	$\text{nV}/\sqrt{\text{Hz}}$
$i_n$	Input Noise Current Density, Balanced	$f = 10\text{kHz}$ , $V_S = 5\text{V}$		0.75		$\text{pA}/\sqrt{\text{Hz}}$
	Input Noise Current Density, Unbalanced			1.1		$\text{pA}/\sqrt{\text{Hz}}$
$C_{\text{IN}}$	Input Capacitance	Common Mode		4		$\text{M}\Omega$
		Differential Mode		12		$\text{k}\Omega$
$A_{\text{VOL}}$	Large Signal Gain	$V_S = 5\text{V}$ , $V_O = 0.5\text{V}$ to $4.5\text{V}$ , $R_L = 1\text{k}$ to $V_S/2$	40	70		$\text{V}/\text{mV}$
		$V_S = 5\text{V}$ , $V_O = 1\text{V}$ to $4\text{V}$ , $R_L = 100$ to $V_S/2$	8.0	14		$\text{V}/\text{mV}$
		$V_S = 3\text{V}$ , $V_O = 0.5\text{V}$ to $2.5\text{V}$ , $R_L = 1\text{k}$ to $V_S/2$	17	40		$\text{V}/\text{mV}$
CMRR	Common Mode Rejection Ratio	$V_S = 5\text{V}$ , $V_{\text{CM}} = V^-$ to $V^+$	60	83		$\text{dB}$
		$V_S = 5\text{V}$ , $V_{\text{CM}} = 1.5\text{V}$ to $3.5\text{V}$	80	100		$\text{dB}$
		$V_S = 3\text{V}$ , $V_{\text{CM}} = V^-$ to $V^+$	56	80		$\text{dB}$
	CMRR Match (Channel-to-Channel) (Note 5)	$V_S = 5\text{V}$ , $V_{\text{CM}} = 1.5\text{V}$ to $3.5\text{V}$	85	120		$\text{dB}$
PSRR	Power Supply Rejection Ratio	$V_S = 2.5\text{V}$ to $10\text{V}$ , $V_{\text{CM}} = 0\text{V}$	60	74		$\text{dB}$
	PSRR Match (Channel-to-Channel) (Note 5)	$V_S = 2.5\text{V}$ to $10\text{V}$ , $V_{\text{CM}} = 0\text{V}$	70	100		$\text{dB}$
	Minimum Supply Voltage (Note 6)		2.5			$\text{V}$
$V_{\text{OL}}$	Output Voltage Swing LOW Saturation (Note 7)	No Load		5	50	$\text{mV}$
		$I_{\text{SINK}} = 5\text{mA}$		85	190	$\text{mV}$
		$V_S = 5\text{V}$ , $I_{\text{SINK}} = 20\text{mA}$		240	460	$\text{mV}$
		$V_S = 3\text{V}$ , $I_{\text{SINK}} = 15\text{mA}$		185	350	$\text{mV}$
$V_{\text{OH}}$	Output Voltage Swing HIGH Saturation (Note 7)	No Load		25	75	$\text{mV}$
		$I_{\text{SOURCE}} = 5\text{mA}$		90	210	$\text{mV}$
		$V_S = 5\text{V}$ , $I_{\text{SOURCE}} = 20\text{mA}$		325	600	$\text{mV}$
		$V_S = 3\text{V}$ , $I_{\text{SOURCE}} = 15\text{mA}$		225	410	$\text{mV}$
$I_{\text{SC}}$	Short-Circuit Current	$V_S = 5\text{V}$	$\pm 30$	$\pm 45$		$\text{mA}$
		$V_S = 3\text{V}$	$\pm 25$	$\pm 40$		$\text{mA}$
$I_S$	Supply Current per Amp	$V_S = 5\text{V}$		2.5	3.0	$\text{mA}$
		$V_S = 3\text{V}$		2.3	2.85	$\text{mA}$
GBW	Gain Bandwidth Product	Frequency = 1MHz, $V_S = 5\text{V}$		90		$\text{MHz}$
SR	Slew Rate	$V_S = 5\text{V}$ , $A_V = -1$ , $R_L = 1\text{k}$ , $V_O = 4\text{V}$	17	24		$\text{V}/\mu\text{s}$
FPBW	Full Power Bandwidth (Note 9)	$V_S = 5\text{V}$ , $V_{\text{OUT}} = 3\text{V}_{\text{P-P}}$	1.8	2.5		$\text{MHz}$
$t_S$	Settling Time	0.1%, $V_S = 5\text{V}$ , $V_{\text{STEP}} = 2\text{V}$ , $A_V = -1$ , $R_L = 1\text{k}$		85		$\text{ns}$

## ELECTRICAL CHARACTERISTICS

The ● denotes the specifications which apply over  $-40^{\circ}\text{C} < T_A < 175^{\circ}\text{C}$  temperature range.  $V_S = 5\text{V}, 0\text{V}$ ;  $V_S = 3\text{V}, 0\text{V}$ ;  $V_{\text{CM}} = V_{\text{OUT}} = \text{half supply}$ , unless otherwise noted. (Note 4)

SYMBOL	PARAMETER	CONDITIONS	MIN	TYP	MAX	UNITS	
$V_{\text{OS}}$	Input Offset Voltage	$V_S = 5\text{V}, 0\text{V}, V_{\text{CM}} = \text{Half Supply}$	●	0.2	1.6	mV	
		$V_S = 3\text{V}, 0\text{V}, V_{\text{CM}} = \text{Half Supply}$	●	0.6	2.0	mV	
		$V_S = 5\text{V}, 0\text{V}, V_{\text{CM}} = V^+ \text{ to } V^-$	●	1.0	5.0	mV	
		$V_S = 3\text{V}, 0\text{V}, V_{\text{CM}} = V^+ \text{ to } V^-$	●	1.4	4.5	mV	
$V_{\text{OS TC}}$	Input Offset Voltage Drift (Note 8)	$V_{\text{CM}} = \text{Half Supply}$	●	3.0	9.0	$\mu\text{V}/^{\circ}\text{C}$	
	Input Offset Voltage Match (Channel-to-Channel) (Note 5)	$V_{\text{CM}} = \text{Half Supply}$	●	0.3	1.5	mV	
		$V_{\text{CM}} = V^- \text{ to } V^+$	●	0.7	4.0	mV	
$I_B$	Input Bias Current	$V_{\text{CM}} = \text{Half Supply}$	●	-7.4	-1.3	$\mu\text{A}$	
		$V_{\text{CM}} = V^+$	●		1.3	$\mu\text{A}$	
		$V_{\text{CM}} = V^- + 100\text{mV}$	●	-14.0	-3.3	$\mu\text{A}$	
$\Delta I_B$	$I_B$ Shift	$V_{\text{CM}} = V^- + 100\text{mV} \text{ to } V^+$	●	4.7	16.0	$\mu\text{A}$	
	$I_B$ Match (Channel-to-Channel) (Note 5)		●	0.1	1.5	$\mu\text{A}$	
$I_{\text{OS}}$	Input Offset Current	$V_{\text{CM}} = \text{Half Supply}$	●	0.2	1.1	$\mu\text{A}$	
		$V_{\text{CM}} = V^+$	●	0.2	1.6	$\mu\text{A}$	
		$V_{\text{CM}} = V^- + 100\text{mV}$	●	0.2	1.7	$\mu\text{A}$	
$A_{\text{VOL}}$	Large Signal Gain	$V_S = 5\text{V}, V_O = 0.5\text{V} \text{ to } 4.5\text{V}, R_L = 1\text{k} \text{ to } V_S/2$	●	29	60	V/mV	
		$V_S = 5\text{V}, V_O = 1.5\text{V} \text{ to } 3.5\text{V}, R_L = 100 \text{ to } V_S/2$	●	3.7	10	V/mV	
		$V_S = 3\text{V}, V_O = 0.5\text{V} \text{ to } 2.5\text{V}, R_L = 1\text{k} \text{ to } V_S/2$	●	12	32	V/mV	
CMRR	Common Mode Rejection Ratio	$V_S = 5\text{V}, V_{\text{CM}} = V^- \text{ to } V^+$	●	60	80	dB	
		$V_S = 5\text{V}, V_{\text{CM}} = 1.5\text{V} \text{ to } 3.5\text{V}$	●	75	95	dB	
		$V_S = 3\text{V}, V_{\text{CM}} = V^- \text{ to } V^+$	●	50	75	dB	
	CMRR Match (Channel-to-Channel) (Note 5)	$V_S = 5\text{V}, V_{\text{CM}} = 1.5\text{V} \text{ to } 3.5\text{V}$	●	80	100	dB	
PSRR	Power Supply Rejection Ratio	$V_S = 3\text{V} \text{ to } 10\text{V}, V_{\text{CM}} = 0\text{V}$	●	60	70	dB	
		PSRR Match (Channel-to-Channel) (Note 5)	$V_S = 3\text{V} \text{ to } 10\text{V}, V_{\text{CM}} = 0\text{V}$	●	70	100	dB
		Minimum Supply Voltage (Note 6)		●	3.0		V
$V_{\text{OL}}$	Output Voltage Swing LOW Saturation (Note 7)	No Load	●	6	70	mV	
		$I_{\text{SINK}} = 5\text{mA}$	●	95	220	mV	
		$I_{\text{SINK}} = 15\text{mA}$	●	210	420	mV	
$V_{\text{OH}}$	Output Voltage Swing HIGH Saturation (Note 7)	No Load	●	55	175	mV	
		$I_{\text{SOURCE}} = 5\text{mA}$	●	125	255	mV	
		$V_S = 5\text{V}, I_{\text{SOURCE}} = 15\text{mA}$	●	370	650	mV	
		$V_S = 3\text{V}, I_{\text{SOURCE}} = 15\text{mA}$	●	270	670	mV	
$I_{\text{SC}}$	Short-Circuit Current	$V_S = 5\text{V}$	●	$\pm 15$	$\pm 25$	mA	
		$V_S = 3\text{V}$	●	$\pm 15$	$\pm 23$	mA	
$I_S$	Supply Current per Amp	$V_S = 5\text{V}$	●	3.3	6.0	mA	
		$V_S = 3\text{V}$	●	3.0	5.3	mA	
GBW	Gain Bandwidth Product	Frequency = 1MHz	●	83		MHz	
SR	Slew Rate	$V_S = 5\text{V}, A_V = -1, R_L = 1\text{k}, V_O = 4\text{V}$	●	12	17	V/ $\mu\text{s}$	
FPBW	Full Power Bandwidth (Note 9)	$V_S = 5\text{V}, V_{\text{OUT}} = 3\text{V}_{\text{P-P}}$	●	1.3	1.8	MHz	

**ELECTRICAL CHARACTERISTICS**  $T_A = 25^\circ\text{C}$ ,  $V_S = \pm 5\text{V}$ ;  $V_{CM} = V_{OUT} = 0\text{V}$ , unless otherwise noted.

SYMBOL	PARAMETER	CONDITIONS	MIN	TYP	MAX	UNITS
$V_{OS}$	Input Offset Voltage	$V_{CM} = 0\text{V}$		1.0	2.5	mV
		$V_{CM} = V^+$		2.6	5.5	mV
		$V_{CM} = V^-$		2.3	5.0	mV
	Input Offset Voltage Match (Channel-to-Channel) (Note 5)	$V_{CM} = 0\text{V}$ $V_{CM} = V^- \text{ to } V^+$		0.2 0.4	1.0 2.0	mV mV
$I_B$	Input Bias Current	$V_{CM} = \text{Half Supply}$	-7.0	-1.3		$\mu\text{A}$
		$V_{CM} = V^+$		1.3	3.0	$\mu\text{A}$
		$V_{CM} = V^-$	-9.5	-3.8		$\mu\text{A}$
$\Delta I_B$	$I_B$ Shift	$V_{CM} = V^- \text{ to } V^+$		5.3	12.5	$\mu\text{A}$
	$I_B$ Match (Channel-to-Channel) (Note 5)			0.1	0.6	$\mu\text{A}$
$I_{OS}$	Input Offset Current	$V_{CM} = \text{Half Supply}$		0.15	1	$\mu\text{A}$
		$V_{CM} = V^+$		0.2	1.2	$\mu\text{A}$
		$V_{CM} = V^-$		0.35	1.3	$\mu\text{A}$
	Input Noise Voltage	0.1Hz to 10Hz		800		nV <sub>P-P</sub>
$e_n$	Input Noise Voltage Density	$f = 100\text{kHz}$		1.9		nV/ $\sqrt{\text{Hz}}$
		$f = 10\text{kHz}$		2.8	4.5	nV/ $\sqrt{\text{Hz}}$
$i_n$	Input Noise Current Density, Balanced Input Noise Current Density, Unbalanced	$f = 10\text{kHz}$		0.75		pA/ $\sqrt{\text{Hz}}$
					1.1	
$C_{IN}$	Input Capacitance	Common Mode		4		M $\Omega$
		Differential Mode		12		k $\Omega$
$C_{IN}$	Input Capacitance	Common Mode		1.8		pF
		Differential Mode		1.5		pF
$A_{VOL}$	Large Signal Gain	$V_O = \pm 4.5\text{V}$ , $R_L = 1\text{k}$	75	130		V/mV
		$V_O = \pm 2.5\text{V}$ , $R_L = 100$	11	19		V/mV
CMRR	Common Mode Rejection Ratio	$V_{CM} = V^- \text{ to } V^+$	65	85		dB
		$V_{CM} = -2\text{V to } 2\text{V}$	85	98		dB
	CMRR Match (Channel-to-Channel) (Note 5)	$V_{CM} = -2\text{V to } 2\text{V}$	85	120		dB
PSRR	Power Supply Rejection Ratio	$V_S = \pm 1.25\text{V to } \pm 5\text{V}$	60	74		dB
		$V_S = \pm 1.25\text{V to } \pm 5\text{V}$	70	100		dB
$V_{OL}$	Output Voltage Swing LOW Saturation (Note 7)	No Load		5	50	mV
		$I_{SINK} = 5\text{mA}$		87	190	mV
		$I_{SINK} = 20\text{mA}$		245	460	mV
$V_{OH}$	Output Voltage Swing HIGH Saturation (Note 7)	No Load		40	95	mV
		$I_{SOURCE} = 5\text{mA}$		95	210	mV
		$I_{SOURCE} = 20\text{mA}$		320	600	mV
$I_{SC}$	Short-Circuit Current		$\pm 30$	$\pm 40$		mA
$I_S$	Supply Current per Amp			2.8	3.5	mA
GBW	Gain Bandwidth Product	Frequency = 1MHz	70	100		MHz
SR	Slew Rate	$A_V = -1$ , $R_L = 1\text{k}$ , $V_O = 4\text{V}$	18	25		V/ $\mu\text{s}$
FPBW	Full Power Bandwidth (Note 9)	$V_{OUT} = 3V_{P-P}$	1.9	2.6		MHz
$t_S$	Settling Time	0.1%, $V_{STEP} = 2\text{V}$ , $A_V = -1$ , $R_L = 1\text{k}$		78		ns
dG	Differential Gain (Note 10)	$A_V = 2$ , $R_F = R_G = 499\Omega$ , $R_L = 2\text{k}$		0.05		%
dP	Differential Phase (Note 10)	$A_V = 2$ , $R_F = R_G = 499\Omega$ , $R_L = 2\text{k}$		0.03		DEG

## ELECTRICAL CHARACTERISTICS

The ● denotes the specifications which apply over  $-40^{\circ}\text{C} < T_A < 175^{\circ}\text{C}$  temperature range.  $V_S = \pm 5\text{V}$ ;  $V_{\text{CM}} = V_{\text{OUT}} = 0\text{V}$ , unless otherwise noted. (Note 4)

SYMBOL	PARAMETER	CONDITIONS		MIN	TYP	MAX	UNITS
$V_{\text{OS}}$	Input Offset Voltage	$V_{\text{CM}} = 0\text{V}$	●		1.7	3.7	mV
		$V_{\text{CM}} = V^+$	●		3.8	9.1	mV
		$V_{\text{CM}} = V^-$	●		3.5	7.6	mV
$V_{\text{OS TC}}$	Input Offset Voltage Drift (Note 8)	$V_{\text{CM}} = \text{Half Supply}$	●		7.5	24	$\mu\text{V}/^{\circ}\text{C}$
		Input Offset Voltage Match (Channel-to-Channel) (Note 5)			0.3	1.2	mV
$I_{\text{B}}$	Input Bias Current	$V_{\text{CM}} = \text{Half Supply}$	●	-7.3	-1.4		$\mu\text{A}$
		$V_{\text{CM}} = V^+$	●		1.8	12.0	$\mu\text{A}$
		$V_{\text{CM}} = V^- + 100\text{mV}$	●	-17.0	-4.5		$\mu\text{A}$
$\Delta I_{\text{B}}$	$I_{\text{B}}$ Shift	$V_{\text{CM}} = V^- + 100\text{mV}$ to $V^+$	●		5.4	25	$\mu\text{A}$
	$I_{\text{B}}$ Match (Channel-to-Channel) (Note 5)		●		0.15	3.0	$\mu\text{A}$
$I_{\text{OS}}$	Input Offset Current	$V_{\text{CM}} = \text{Half Supply}$	●		0.15	1.1	$\mu\text{A}$
		$V_{\text{CM}} = V^+$	●		0.3	2.8	$\mu\text{A}$
		$V_{\text{CM}} = V^- + 100\text{mV}$	●		0.5	2.8	$\mu\text{A}$
$A_{\text{VOL}}$	Large Signal Gain	$V_0 = \pm 4.5\text{V}$ , $R_L = 1\text{k}$	●	54	110		V/mV
		$V_0 = \pm 1.5\text{V}$ , $R_L = 100$	●	5.7	13		V/mV
CMRR	Common Mode Rejection Ratio	$V_{\text{CM}} = V^-$ to $V^+$	●	65	84		dB
		$V_{\text{CM}} = -2\text{V}$ to $2\text{V}$	●	79	95		dB
PSRR	Power Supply Rejection Ratio	$V_S = \pm 1.5\text{V}$ to $\pm 5\text{V}$	●	60	70		dB
		PSRR Match (Channel-to-Channel) (Note 5)	●	70	100		dB
$V_{\text{OL}}$	Output Voltage Swing LOW Saturation (Note 7)	No Load	●		7	75	mV
		$I_{\text{SINK}} = 5\text{mA}$	●		98	215	mV
		$I_{\text{SINK}} = 15\text{mA}$	●		260	500	mV
$V_{\text{OH}}$	Output Voltage Swing HIGH Saturation (Note 7)	No Load	●		70	200	mV
		$I_{\text{SOURCE}} = 5\text{mA}$	●		130	270	mV
		$I_{\text{SOURCE}} = 15\text{mA}$	●		360	640	mV
$I_{\text{SC}}$	Short-Circuit Current		●	$\pm 15$	$\pm 25$		mA
$I_{\text{S}}$	Supply Current per Amp		●		3.8	6.3	mA
GBW	Gain Bandwidth Product	Frequency = 1MHz	●		90		MHz
SR	Slew Rate	$A_V = -1$ , $R_L = 1\text{k}$ , $V_0 = 4\text{V}$	●	13	18		V/ $\mu\text{s}$
FPBW	Full Power Bandwidth (Note 9)	$V_{\text{OUT}} = 3V_{\text{P-P}}$	●	1.4	1.9		MHz

**Note 1:** Stresses beyond those listed under Absolute Maximum Ratings may cause permanent damage to the device. Exposure to any Absolute Maximum Rating condition for extended periods may affect device reliability and lifetime.

**Note 2:** Inputs are protected by back-to-back diodes and diodes to each supply. If the inputs are taken beyond the supplies or the differential input voltage exceeds 0.7V, the input current must be limited to less than 40mA.

**Note 3:** A heat sink may be required to keep the junction temperature below the absolute maximum rating when the output is shorted indefinitely.

**Note 4:** The LT6203X is guaranteed to meet specified performance from  $-40^{\circ}\text{C}$  to  $175^{\circ}\text{C}$ .

**Note 5:** Matching parameters are the difference between the two amplifiers of the LT6203X. CMRR and PSRR match are defined as follows: CMRR and PSRR are measured in  $\mu\text{V}/\text{V}$  on the identical amplifiers. The difference is calculated between the matching sides in  $\mu\text{V}/\text{V}$ . The result is converted to dB.

**Note 6:** Minimum supply voltage is guaranteed by power supply rejection ratio test.

**Note 7:** Output voltage swings are measured between the output and power supply rails.

**Note 8:** This parameter is not 100% tested.

**Note 9:** Full-power bandwidth is calculated from the slew rate:  $\text{FPBW} = \text{SR}/2\pi V_{\text{P}}$

**Note 10:** Differential gain and phase are measured using a Tektronix TSG120YC/NTSC signal generator and a Tektronix 1780R Video Measurement Set. The resolution of this equipment is 0.1% and  $0.1^{\circ}$ . Ten identical amplifier stages were cascaded giving an effective resolution of 0.01% and  $0.01^{\circ}$ .

# TYPICAL PERFORMANCE CHARACTERISTICS

**$V_{OS}$  Distribution,  $V_{CM} = V^+/2$**

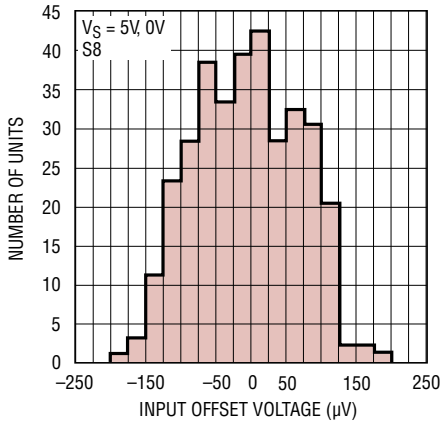

6203X G01

**$V_{OS}$  Distribution,  $V_{CM} = V^+$**

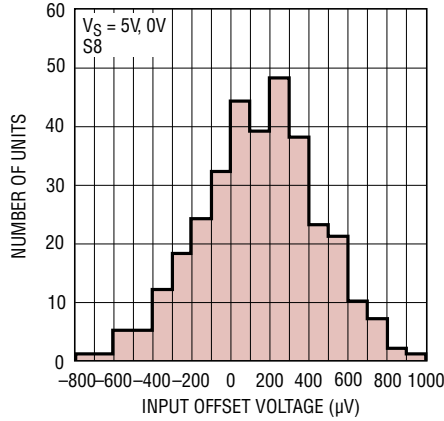

6203X G02

**$V_{OS}$  Distribution,  $V_{CM} = V^-$**

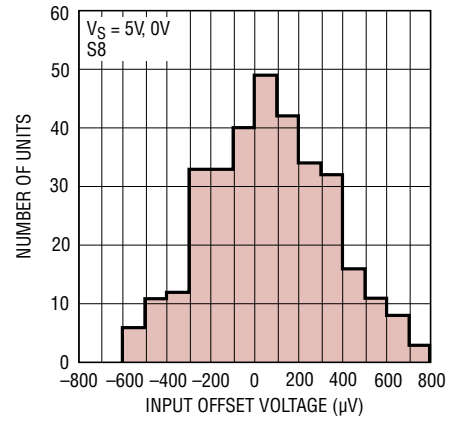

6203X G03

**Supply Current vs Supply Voltage (Both Amplifiers)**

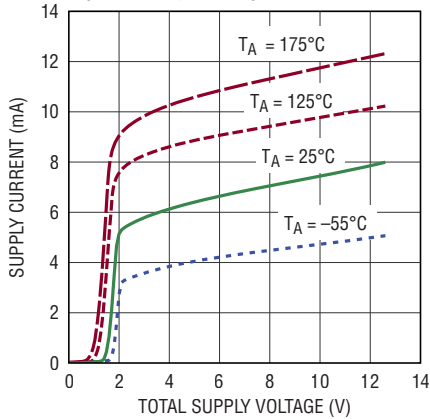

6203X G04

**Offset Voltage vs Input Common Mode Voltage**

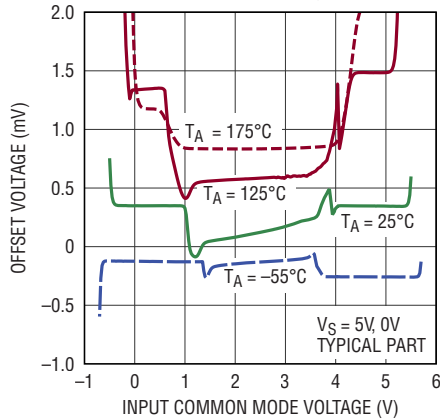

6203X G05

**Input Bias Current vs Common Mode Voltage**

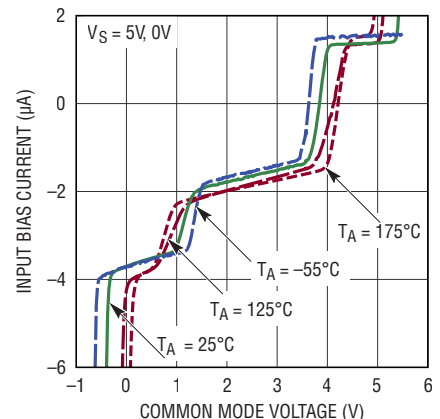

6203X G06

**Input Bias Current vs Temperature**

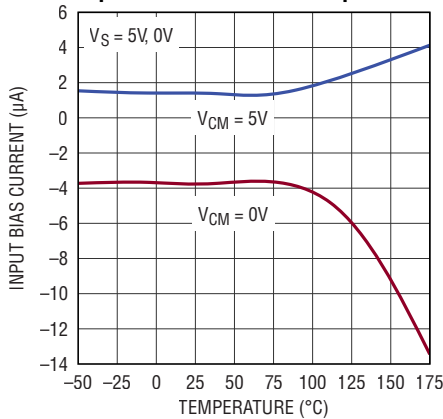

6203X G07

**Output Saturation Voltage vs Load Current (Output Low)**

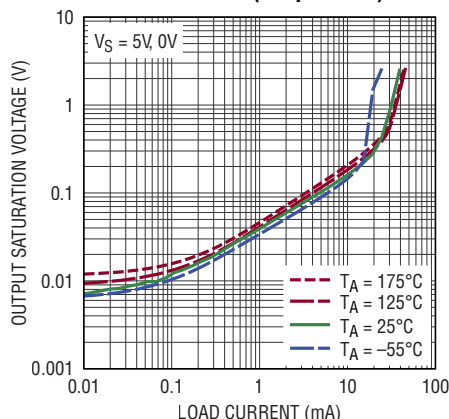

6203X G08

**Output Saturation Voltage vs Load Current (Output High)**

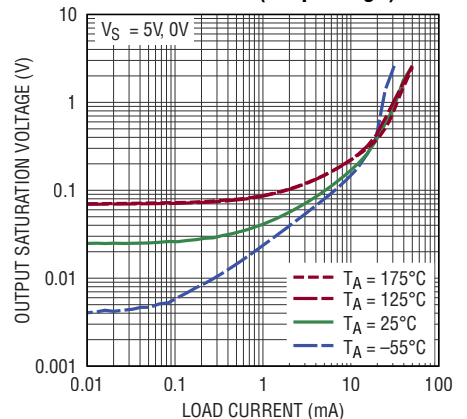

6203X G09

## TYPICAL PERFORMANCE CHARACTERISTICS

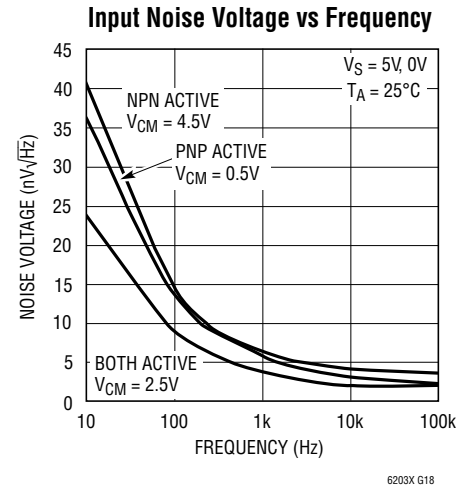
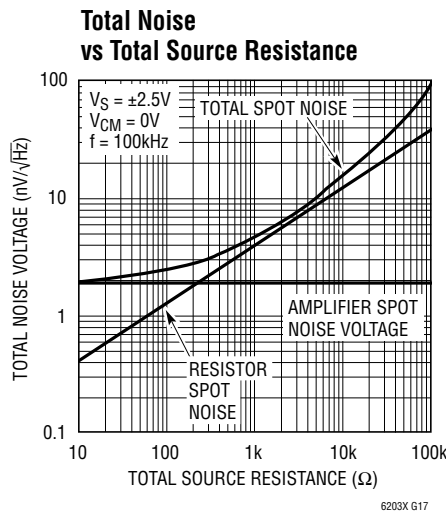
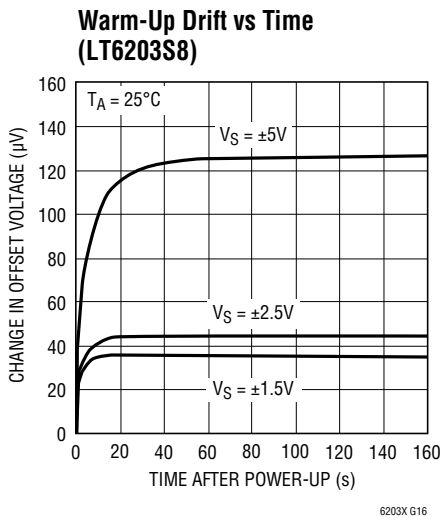
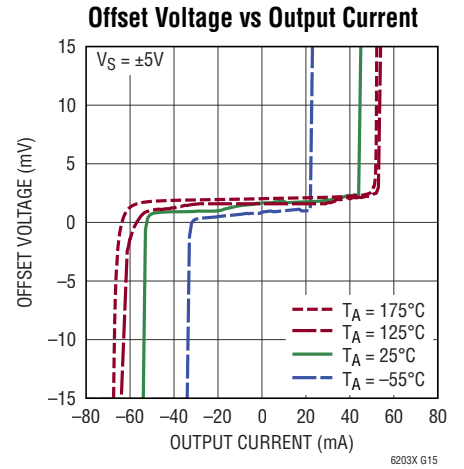
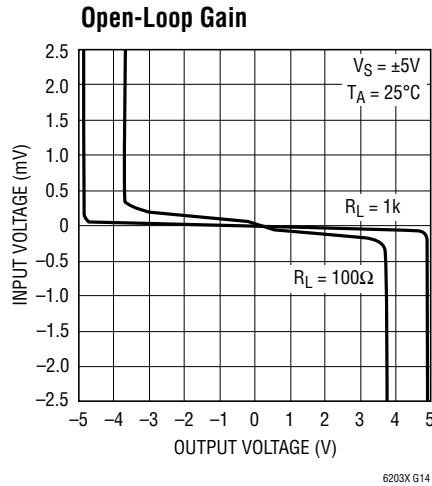
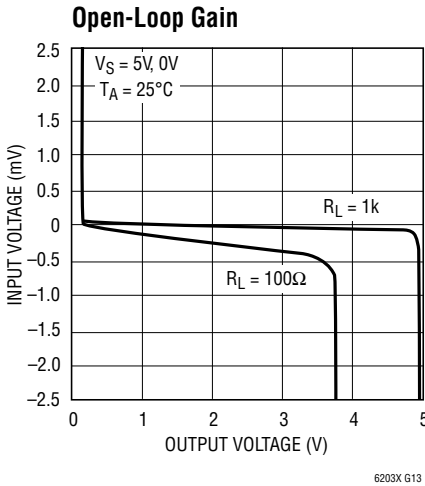
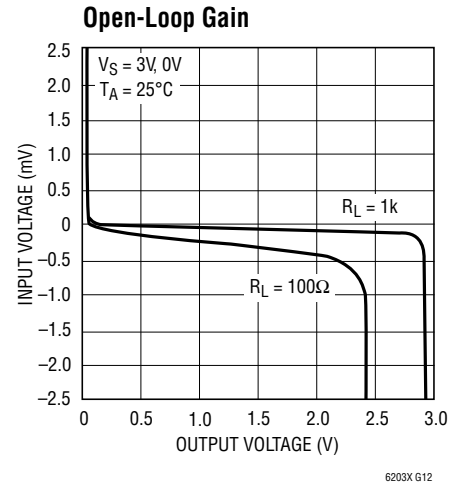
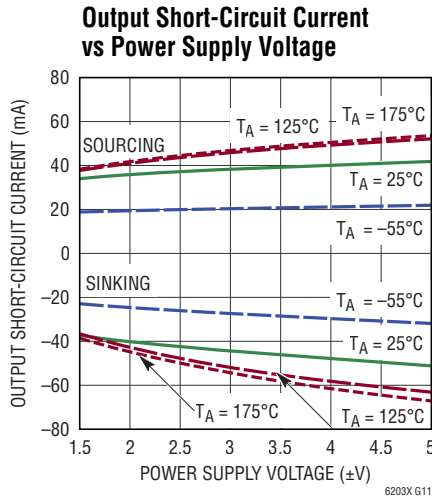
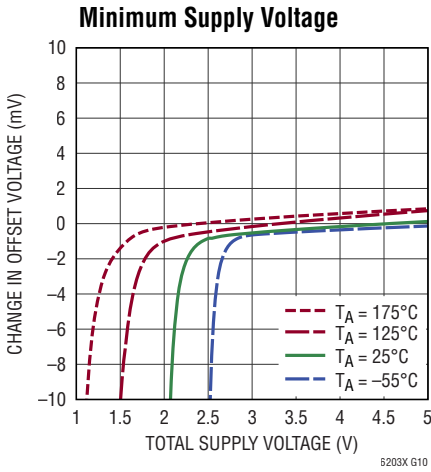



# TYPICAL PERFORMANCE CHARACTERISTICS

**Balanced Noise Current vs Frequency**

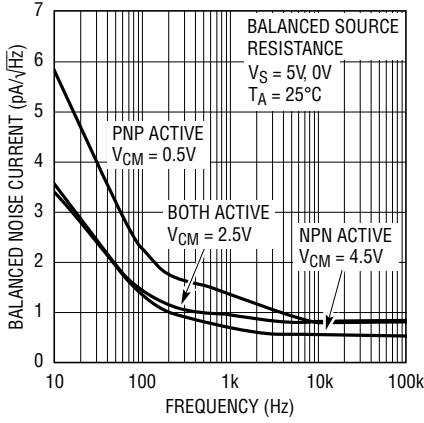

6203X G19

**Unbalanced Noise Current vs Frequency**

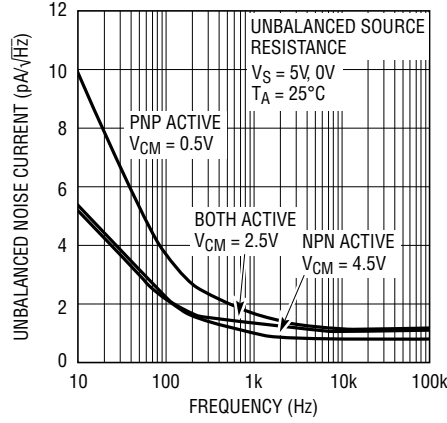

6203X G20

**0.1Hz to 10Hz Output Voltage Noise**

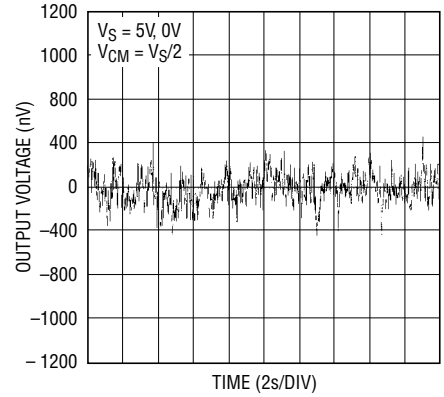

6203X G21

**Gain Bandwidth vs Temperature**

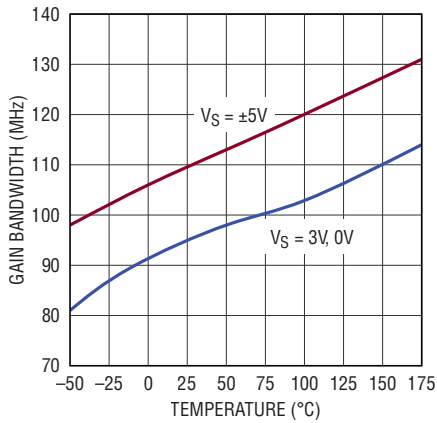

6203X G22

**Phase Margin vs Temperature**

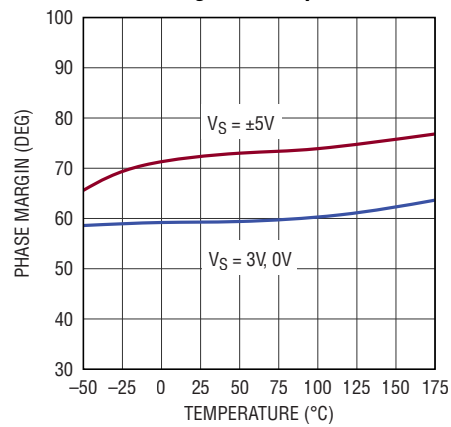

6203X G23

**Open-Loop Gain vs Frequency**

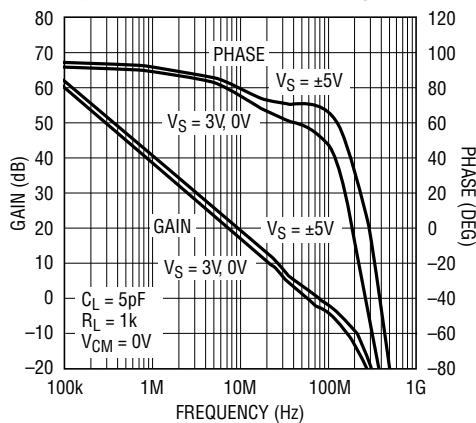

6203X G24

**Open-Loop Gain vs Frequency**

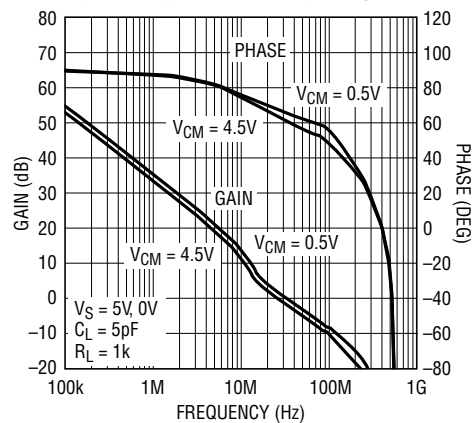

6203X G25

TYPICAL PERFORMANCE CHARACTERISTICS

Gain Bandwidth and Phase Margin vs Supply Voltage

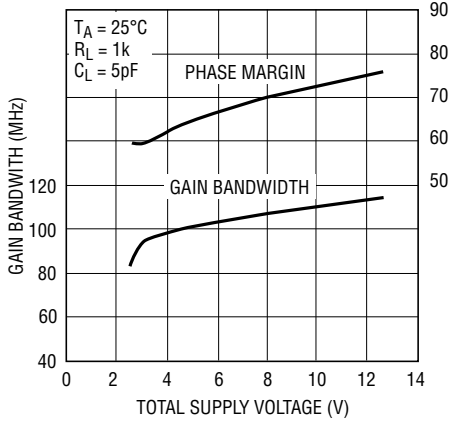

6203X G26

Slew Rate vs Temperature

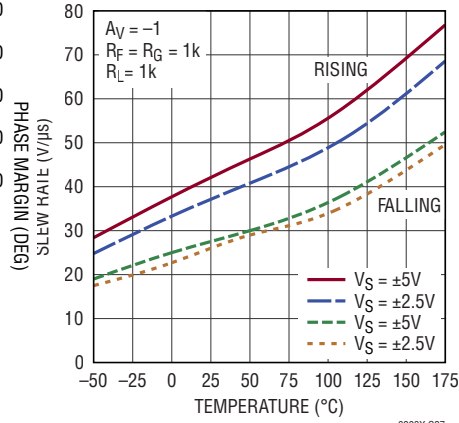

6203X G27

Output Impedance vs Frequency

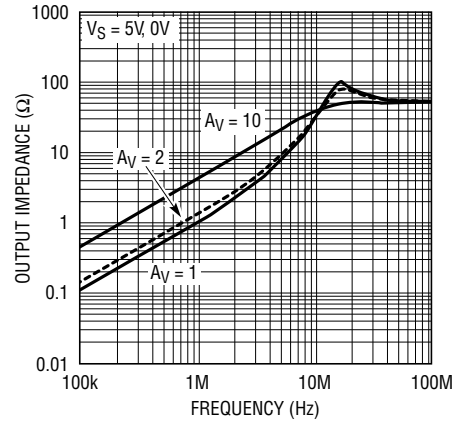

6203X G28

Common Mode Rejection Ratio vs Frequency

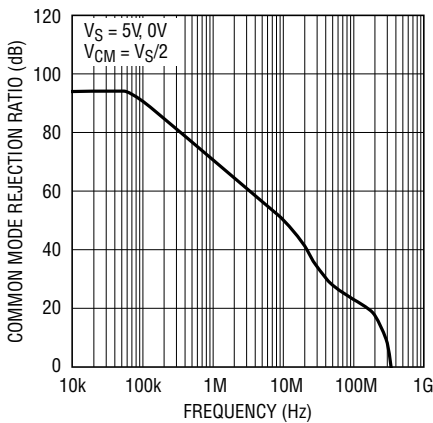

6203X G29

Channel Separation vs Frequency

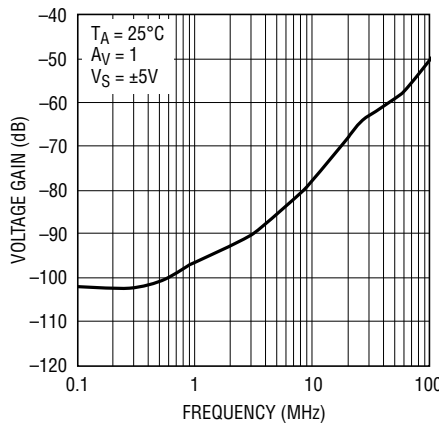

6203X G30

Power Supply Rejection Ratio vs Frequency

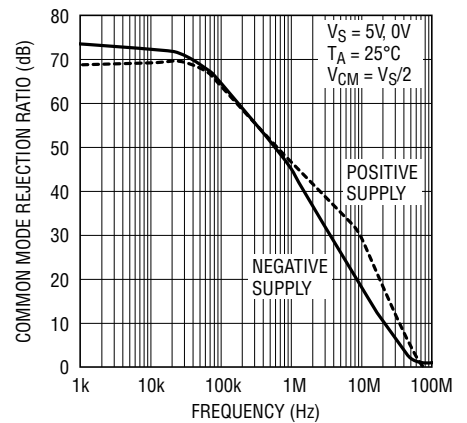

6203X G31

Series Output Resistor vs Capacitive Load

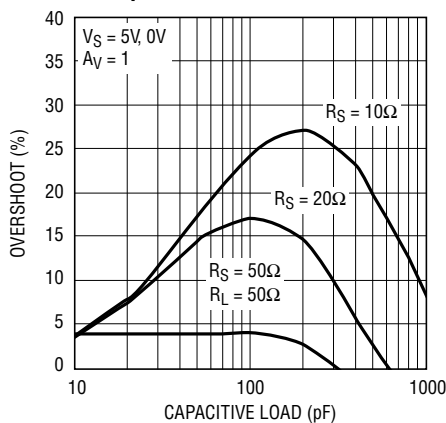

6203X G32

Series Output Resistor vs Capacitive Load

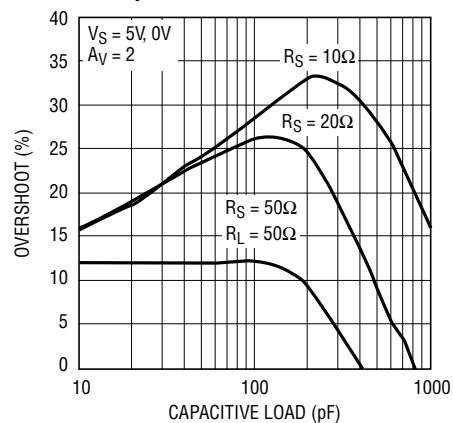

6203X G33

# TYPICAL PERFORMANCE CHARACTERISTICS

**Settling Time vs Output Step (Noninverting)**

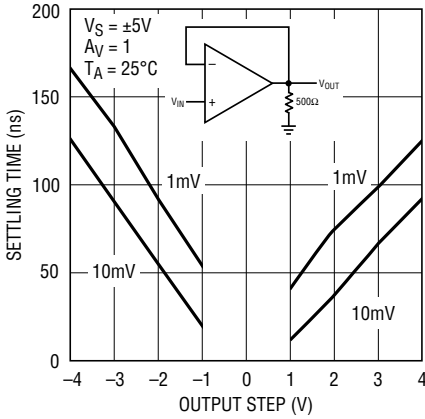

6203X G34

**Settling Time vs Output Step (Inverting)**

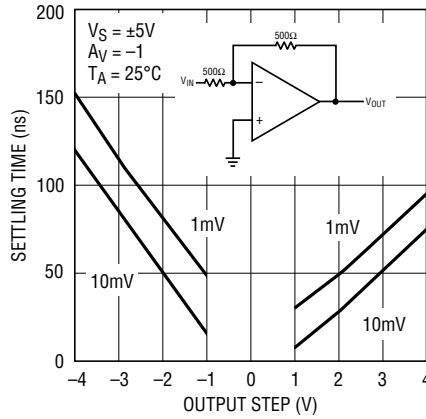

6203X G35

**Maximum Undistorted Output Signal vs Frequency**

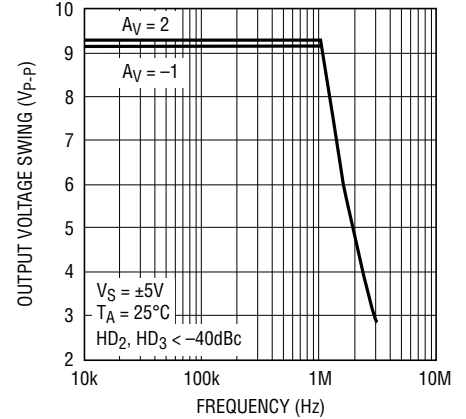

6203X G36

**Distortion vs Frequency**

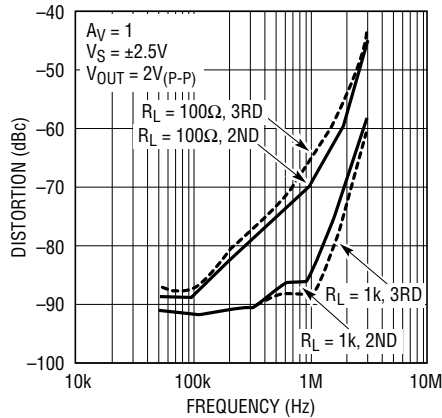

6203X G37

**Distortion vs Frequency**

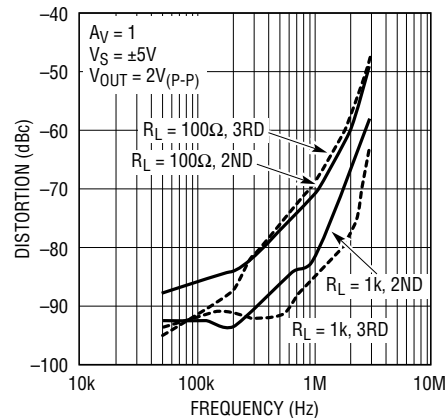

6203X G38

**Distortion vs Frequency**

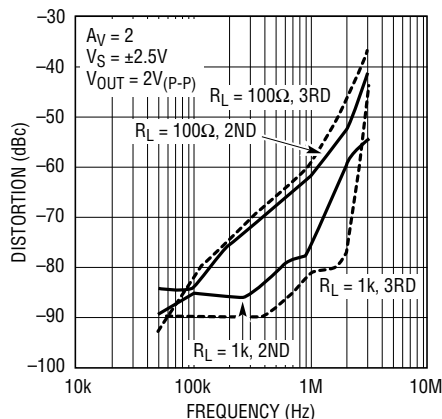

6203X G39

**Distortion vs Frequency**

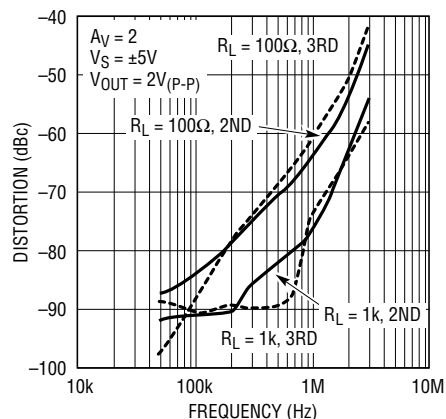

6203X G40

## TYPICAL PERFORMANCE CHARACTERISTICS

**5V Large-Signal Response**

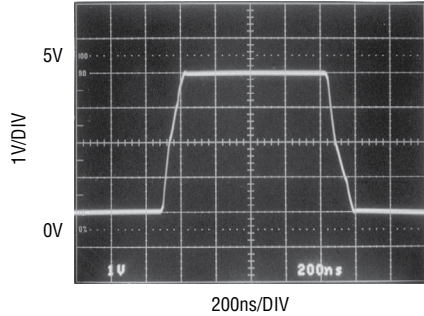

$V_S = 5V, 0V$   
 $A_V = 1$   
 $R_L = 1k$   
 6203X G41

**5V Small-Signal Response**

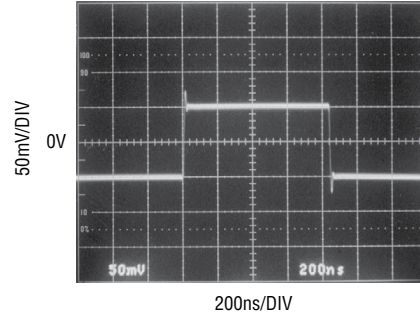

$V_S = 5V, 0V$   
 $A_V = 1$   
 $R_L = 1k$   
 6203X G42

**±5V Large-Signal Response**

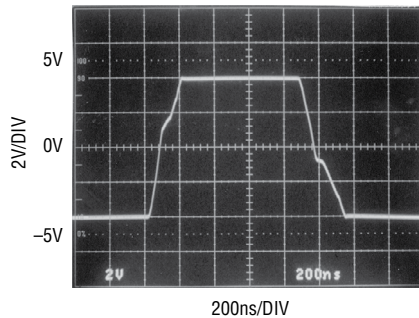

$V_S = \pm 5V$   
 $A_V = 1$   
 $R_L = 1k$   
 6203X G43

**Output-Overdrive Recovery**

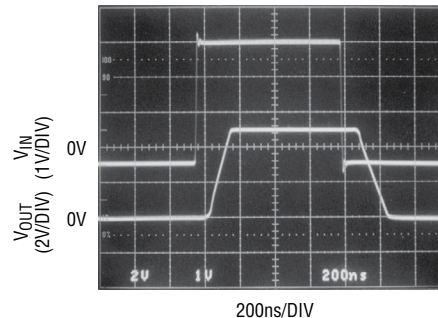

$V_S = 5V, 0V$   
 $A_V = 2$   
 6203X G44

## PIN FUNCTIONS

**OUT A (Pin 1):** Amplifier A Output. The output swings rail-to-rail and can source/sink a minimum of 15mA over temperature.

**-IN A (Pin 2):** Inverting Input of Amplifier A. Valid input range is from  $V^-$  to  $V^+$ .

**+IN A (Pin 3):** Non-Inverting Input of Amplifier A. Valid input range is from  $V^-$  to  $V^+$ .

**$V^-$  (Pin 4):** Negative Supply Voltage.  $V^+$  and  $V^-$  must be chosen so that  $3V \leq (V^+ - V^-) < 12.6V$ .

**+IN B (Pin 5):** Non-Inverting Input of Amplifier B. Valid input range from  $V^-$  to  $V^+$ .

**-IN B (Pin 6):** Inverting Input of Amplifier B. Valid input range from  $V^-$  to  $V^+$ .

**OUT B (Pin 7):** Amplifier B Output. The output swings rail-to-rail and can source/sink a minimum of 15mA over temperature.

**$V^+$  (Pin 8):** Positive Supply Voltage.  $V^+$  and  $V^-$  must be chosen so that  $3V \leq (V^+ - V^-) < 12.6V$ .

## APPLICATIONS INFORMATION

### Amplifier Characteristics

Figure 1 shows a simplified schematic of the LT6203X, which has two input differential amplifiers in parallel that are biased on simultaneously when the common mode voltage is at least 1.5V from either rail. This topology allows the input stage to swing from the positive supply voltage to the negative supply voltage. As the common mode voltage swings beyond  $V_{CC} - 1.5V$ , current source  $I_1$  saturates and current in Q1/Q4 is zero. Feedback is maintained through the Q2/Q3 differential amplifier, but with an input  $g_m$  reduction of 1/2. A similar effect occurs with  $I_2$  when the common mode voltage swings within 1.5V of the negative rail. The effect of the  $g_m$  reduction is a shift in the  $V_{OS}$  as  $I_1$  or  $I_2$  saturate.

Input bias current normally flows out of the + and – inputs. The magnitude of this current increases when the input common mode voltage is within 1.5V of the negative rail, and only Q1/Q4 are active. The polarity of this current reverses when the input common mode voltage is within 1.5V of the positive rail and only Q2/Q3 are active.

The second stage is a folded cascode and current mirror that converts the input stage differential signals to a single ended output. Capacitor C1 reduces the unity cross frequency and improves the frequency stability without degrading the gain bandwidth of the amplifier. The differential drive generator supplies current to the output transistors that swing from rail-to-rail.

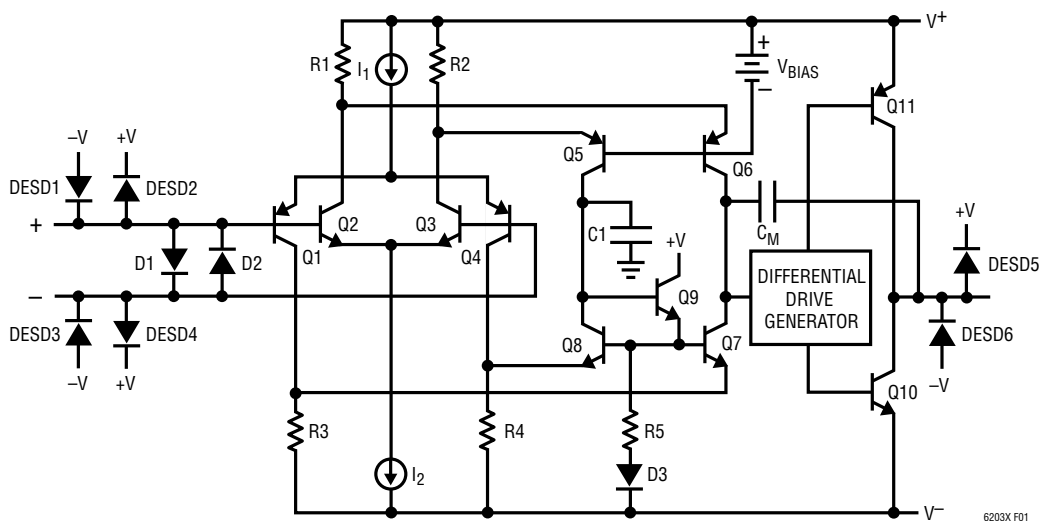

Figure 1. Simplified Schematic

## APPLICATIONS INFORMATION

### Input Protection

There are back-to-back diodes, D1 and D2, across the + and – inputs of these amplifiers to limit the differential input voltage to  $\pm 0.7V$ . The inputs of the LT6203X do not have internal resistors in series with the input transistors. This technique is often used to protect the input devices from over voltage that causes excessive currents to flow. The addition of these resistors would significantly degrade the low noise voltage of these amplifiers. For instance, a  $100\Omega$  resistor in series with each input would generate  $1.8nV/\sqrt{Hz}$  of noise, and the total amplifier noise voltage would rise from  $1.9nV/\sqrt{Hz}$  to  $2.6nV/\sqrt{Hz}$ . Once the input differential voltage exceeds  $\pm 0.7V$ , steady state current conducted through the protection diodes should be limited to  $\pm 40mA$ . This implies  $25\Omega$  of protection resistance per volt of continuous overdrive beyond  $\pm 0.7V$ . The input diodes are rugged enough to handle transient currents due to amplifier slew rate overdrive or momentary clipping without these resistors.

Figure 2 shows the input and output waveforms of the amplifier driven into clipping while connected in a gain of  $A_V = 1$ . When the input signal goes sufficiently beyond the power supply rails, the input transistors will saturate. When saturation occurs, the amplifier loses a stage of phase inversion and the output tries to change states. Diodes D1 and D2 forward bias and hold the output within

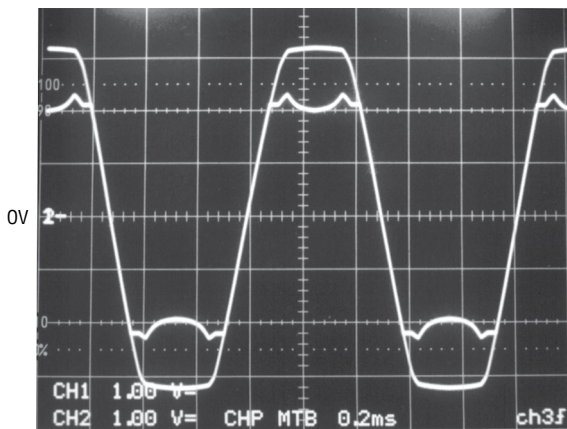

Figure 2.  $V_S = \pm 2.5V$ ,  $A_V = 1$  with Large Overdrive

a diode drop of the input signal. In this photo, the input signal generator is clipping at  $\pm 35mA$ , and the output transistors supply this generator current through the protection diodes.

With the amplifier connected in a gain of  $A_V \geq 2$ , the output can invert with very heavy input overdrive. To avoid this inversion, limit the input overdrive to  $0.5V$  beyond the power supply rails.

### ESD

The LT6203X has reverse-biased ESD protection diodes on all inputs and outputs as shown in Figure 1. If these pins are forced beyond either supply, unlimited current will flow through these diodes. If the current is transient and limited to one hundred milliamps or less, no damage to the device will occur.

### Noise

The noise voltage of the LT6203X is equivalent to that of a  $225\Omega$  resistor, and for the lowest possible noise it is desirable to keep the source and feedback resistance at or below this value, i.e.  $R_S + R_G \parallel R_{FB} \leq 225\Omega$ . With  $R_S + R_G \parallel R_{FB} = 225\Omega$  the total noise of the amplifier is:  $e_n = \sqrt{(1.9nV)^2 + (1.9nV)^2} = 2.7nV$ . Below this resistance value, the amplifier dominates the noise, but in the resistance region between  $225\Omega$  and approximately  $10k\Omega$ , the noise is dominated by the resistor thermal noise. As the total resistance is further increased, beyond  $10k$ , the noise current multiplied by the total resistance eventually dominates the noise.

The product of  $e_n \cdot \sqrt{I_{SUPPLY}}$  is an interesting way to gauge low noise amplifiers. Many low noise amplifiers with low  $e_n$  have high  $I_{SUPPLY}$  current. In applications that require low noise with the lowest possible supply current, this product can prove to be enlightening. The LT6203X has an  $e_n \cdot \sqrt{I_{SUPPLY}}$  product of 3.2 per amplifier, yet it is common to see amplifiers with similar noise specifications have an  $e_n \cdot \sqrt{I_{SUPPLY}}$  product of 4.7 to 13.5.

For a complete discussion of amplifier noise, see the LT1028 data sheet.

# PACKAGE DESCRIPTION

Please refer to <http://www.linear.com/product/LT6203X#packaging> for the most recent package drawings.

## S8 Package 8-Lead Plastic Small Outline (Narrow .150 Inch) (Reference LTC DWG # 05-08-1610 Rev G)

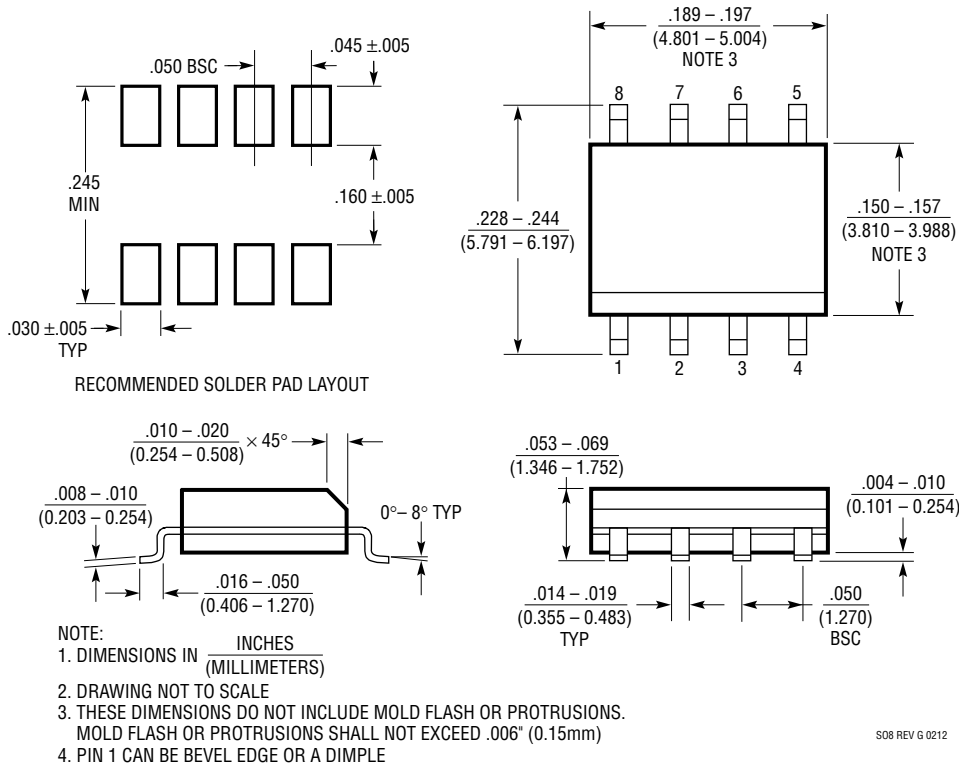

## TYPICAL APPLICATION

### Low Noise Differential Amplifier with Gain Adjust and Common Mode Control

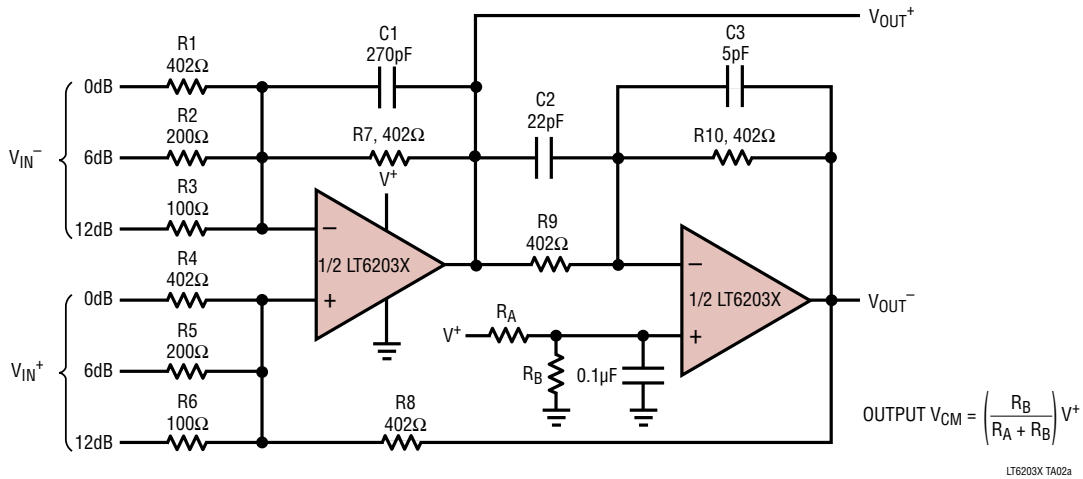

### Low Noise Differential Amplifier Frequency Response

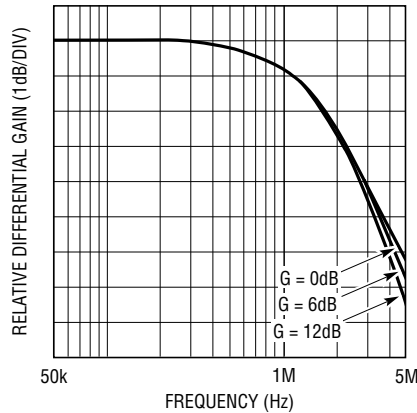

## RELATED PARTS

PART NUMBER	DESCRIPTION	COMMENTS
<a href="#">LT1028</a>	Single, Ultralow Noise 50MHz Op Amp	0.85nV/ $\sqrt{\text{Hz}}$
<a href="#">LT1677</a>	Single, Low Noise Rail-to-Rail Amplifier	3V Operation, 2.5mA, 4.5nV/ $\sqrt{\text{Hz}}$ , 60 $\mu\text{V}$ Max $V_{OS}$
<a href="#">LT1722/LT1723/LT1724</a>	Single/Dual/Quad Low Noise Precision Op Amps	70V/ $\mu\text{s}$ Slew Rate, 400 $\mu\text{V}$ Max $V_{OS}$ , 3.8nV/ $\sqrt{\text{Hz}}$ , 3.7mA
<a href="#">LT1800/LT1801/LT1802</a>	Single/Dual/Quad Low Power 80MHz Rail-to-Rail Op Amps	8.5nV/ $\sqrt{\text{Hz}}$ , 2mA Max Supply
<a href="#">LT1806/LT1807</a>	Single/Dual, Low Noise 325MHz Rail-to-Rail Amplifiers	2.5V Operation, 550 $\mu\text{V}$ Max $V_{OS}$ , 3.5nV/ $\sqrt{\text{Hz}}$
<a href="#">LT6200</a>	Single Ultralow Noise Rail-to-Rail Amplifier	0.95nV/ $\sqrt{\text{Hz}}$ , 165MHz Gain Bandwidth





Компания «ЭлектроПласт» предлагает заключение долгосрочных отношений при поставках импортных электронных компонентов на взаимовыгодных условиях!

Наши преимущества:

- Оперативные поставки широкого спектра электронных компонентов отечественного и импортного производства напрямую от производителей и с крупнейших мировых складов;
- Поставка более 17-ти миллионов наименований электронных компонентов;
- Поставка сложных, дефицитных, либо снятых с производства позиций;
- Оперативные сроки поставки под заказ (от 5 рабочих дней);
- Экспресс доставка в любую точку России;
- Техническая поддержка проекта, помощь в подборе аналогов, поставка прототипов;
- Система менеджмента качества сертифицирована по Международному стандарту ISO 9001;
- Лицензия ФСБ на осуществление работ с использованием сведений, составляющих государственную тайну;
- Поставка специализированных компонентов (Xilinx, Altera, Analog Devices, Intersil, Interpoint, Microsemi, Aeroflex, Peregrine, Syfer, Eurofarad, Texas Instrument, Miteq, Cobham, E2V, MA-COM, Hittite, Mini-Circuits, General Dynamics и др.);

Помимо этого, одним из направлений компании «ЭлектроПласт» является направление «Источники питания». Мы предлагаем Вам помощь Конструкторского отдела:

- Подбор оптимального решения, техническое обоснование при выборе компонента;
- Подбор аналогов;
- Консультации по применению компонента;
- Поставка образцов и прототипов;
- Техническая поддержка проекта;
- Защита от снятия компонента с производства.



#### Как с нами связаться

**Телефон:** 8 (812) 309 58 32 (многоканальный)

**Факс:** 8 (812) 320-02-42

**Электронная почта:** [org@eplast1.ru](mailto:org@eplast1.ru)

**Адрес:** 198099, г. Санкт-Петербург, ул. Калинина, дом 2, корпус 4, литера А.