

Cree® XLamp® XP-E2 LEDs



PRODUCT DESCRIPTION

The XLamp® XP-E2 LED builds on the unprecedented performance of the original XP-E by increasing lumen output up to 20% while providing a single die LED point source for precise optical control. The XP-E2 LED shares the same footprint as the original XP-E, providing a seamless upgrade path to more lumens and/or greater efficiency while shortening the design cycle for existing XP customers.

XLamp XP-E2 LEDs are the ideal choice for lighting applications where high light output and maximum efficacy are required, such as LED retrofit lamps, outdoor, portable, indoor directional, emergency vehicle or architectural.

FEATURES

- Available in white, outdoor white, 80-CRI, 85-CRI, 90-CRI white, royal blue, blue, green, PC amber, amber, red-orange, red, photo red & far red
- ANSI-compatible chromaticity bins
- White binned at 85 °C
- Maximum drive current: 1 A
- Low thermal resistance: as low as 5 °C/W
- Wide viewing angle: 110°-140°
- Unlimited floor life at ≤ 30 °C/85% RH
- Reflow solderable - JEDEC J-STD-020C compatible
- Electrically neutral thermal path
- RoHS and REACH compliant
- UL® recognized component (E349212)



TABLE OF CONTENTS

Characteristics	3
Flux Characteristics - White.....	4
Flux Characteristics - Color	10
Relative Spectral Power Distribution	16
Relative Flux vs. Junction Temperature.....	17
Electrical Characteristics - White	18
Electrical Characteristics - Color.....	18
Relative Flux vs. Current - White.....	19
Relative Flux vs. Current - Color	19
Relative Chromaticity vs. Current and Temperature	20
Typical Spatial Distribution.....	21
Thermal Design.....	22
Performance Groups - Luminous Flux.....	24
Performance Groups - Radiant Flux.....	25
Performance Groups - Chromaticity.....	26
Performance Groups - Dominant Wavelength	29
Performance Groups - Peak Wavelength.....	30
Performance Groups - Forward Voltage.....	30
Cree's Standard Chromaticity Regions Plotted on the 1931 CIE Curve.....	31
Cree's Standard Cool White Kits Plotted on ANSI Standard Chromaticity Regions.....	32
Cree's Standard Warm and Neutral White Kits Plotted on ANSI Standard Chromaticity Regions.....	33
Cree's PC Amber Kit Plotted on the 1931 CIE Curve.....	34
Cree's 2200 K CCT White Kits Plotted on ANSI Standard Chromaticity Regions.....	35
Cree's Standard Chromaticity Kits	36
Bin and Order Code Formats.....	37
Reflow Soldering Characteristics.....	38
Notes	39
Mechanical Dimensions	41
Tape and Reel.....	42
Packaging.....	43

CHARACTERISTICS

Characteristics	Unit	Minimum	Typical	Maximum
Thermal resistance, junction to solder point - white, royal blue, blue	°C/W		9	
Thermal resistance, junction to solder point - green	°C/W		15	
Thermal resistance, junction to solder point - PC amber	°C/W		9	
Thermal resistance, junction to solder point - amber	°C/W		7	
Thermal resistance, junction to solder point - red-orange, red	°C/W		5	
Thermal resistance, junction to solder point - photo red, far red	°C/W		8	
Viewing angle (FWHM) - white	degrees		110	
Viewing angle (FWHM) - royal blue, blue, green	degrees		135	
Viewing angle (FWHM) - PC amber	degrees		110	
Viewing angle (FWHM) - amber, red-orange, red, photo red	degrees		130	
Viewing angle (FWHM) - far red	degrees		140	
Temperature coefficient of voltage - white	mV/°C		-2.3	
Temperature coefficient of voltage - royal blue, blue	mV/°C		-3.3	
Temperature coefficient of voltage - green	mV/°C		-3.8	
Temperature coefficient of voltage - PC amber	mV/°C		-2.5	
Temperature coefficient of voltage - amber, red-orange, red	mV/°C		-1.8	
Temperature coefficient of voltage - photo red	mV/°C		-1.6	
Temperature coefficient of voltage - far red	mV/°C		-1.0	
ESD withstand voltage (HBM per Mil-Std-883D)- white, royal blue, blue, green	V			8000
ESD classification (HBM per Mil-Std-883D) - PC amber, amber, red-orange, red, photo red, far red			Class 2	
DC forward current	mA			1000
Reverse voltage	V			5
Forward voltage (@ 350 mA, 85 °C) - white	V		2.9	3.25
Forward voltage (@ 700 mA, 85 °C) - white	V		3.05	
Forward voltage (@ 1000 mA, 85 °C) - white	V		3.15	
Forward voltage (@ 350 mA, 25 °C) - royal blue, blue	V		3.1	3.5
Forward voltage (@ 1000 mA, 25 °C) - royal blue, blue	V		3.4	
Forward voltage (@ 350 mA, 25 °C) - green	V		3.2	3.8
Forward voltage (@ 1000 mA, 25 °C) - green	V		3.7	
Forward voltage (@ 350 mA, 25 °C) - PC amber	V		3.05	3.5
Forward voltage (@ 1000 mA, 25 °C) - PC amber	V		3.28	
Forward voltage (@ 350 mA, 25 °C) - amber, red-orange, red,	V		2.2	2.6
Forward voltage (@ 1000 mA, 25 °C) - amber, red-orange, red	V		2.65	
Forward voltage (@ 350 mA, 25 °C) - photo red	V		2.05	2.5
Forward voltage (@ 1000 mA, 25 °C) - photo red	V		2.42	
Forward voltage (@ 350 mA, 25 °C) - far red	V		1.85	2.4
Forward voltage (@ 1000 mA, 25 °C) - far red	V		2.24	
LED junction temperature	°C			150

FLUX CHARACTERISTICS - WHITE ($T_j = 85\text{ °C}$)

The following tables provide order codes for XLamp XP-E2 white LEDs. For a complete description of the order code nomenclature, please see the Bin and Order Code Formats section (page 37). For definitions of the chromaticity kits, please see the Cree's Standard Chromaticity Kits section (page 36).

Chromaticity		Minimum Luminous Flux @ 350 mA			Calculated Minimum Luminous Flux (lm)** @ 85 °C		Order Codes
Kit	CCT	Code	Flux (lm) @ 85 °C	Flux (lm) @ 25 °C*	700 mA	1.0 A	70 CRI Typical
51	6200 K	R4	130	151	223	284	XPEBWT-L1-0000-00G51
		R3	122	142	209	266	XPEBWT-L1-0000-00F51
		R2	114	132	195	249	XPEBWT-L1-0000-00E51
		Q5	107	124	183	233	XPEBWT-L1-0000-00D51
		Q4	100	116	171	218	XPEBWT-L1-0000-00C51
53	6000 K	R4	130	151	223	284	XPEBWT-L1-0000-00G53
		R3	122	142	209	266	XPEBWT-L1-0000-00F53
		R2	114	132	195	249	XPEBWT-L1-0000-00E53
		Q5	107	124	183	233	XPEBWT-L1-0000-00D53
		Q4	100	116	171	218	XPEBWT-L1-0000-00C53
50	6200 K	R4	130	151	223	284	XPEBWT-L1-0000-00G50
		R3	122	142	209	266	XPEBWT-L1-0000-00F50
		R2	114	132	195	249	XPEBWT-L1-0000-00E50
		Q5	107	124	183	233	XPEBWT-L1-0000-00D50
		Q4	100	116	171	218	XPEBWT-L1-0000-00C50
E1	6500 K	R4	130	151	223	284	XPEBWT-L1-0000-00GE1
		R3	122	142	209	266	XPEBWT-L1-0000-00FE1
		R2	114	132	195	249	XPEBWT-L1-0000-00EE1
		Q5	107	124	183	233	XPEBWT-L1-0000-00DE1
		Q4	100	116	171	218	XPEBWT-L1-0000-00CE1
E2	5700 K	R4	130	151	223	284	XPEBWT-L1-0000-00GE2
		R3	122	142	209	266	XPEBWT-L1-0000-00FE2
		R2	114	132	195	249	XPEBWT-L1-0000-00EE2
		Q5	107	124	183	233	XPEBWT-L1-0000-00DE2
		Q4	100	116	171	218	XPEBWT-L1-0000-00CE2

Notes:

- Cree maintains a tolerance of $\pm 7\%$ on flux and power measurements, ± 0.005 on chromaticity (CCx, CCy) measurements and ± 2 on CRI measurements. See the Measurements section (page 39).
 - Cree XLamp XP-E2 LED order codes specify only a minimum flux bin and not a maximum. Cree may ship reels in flux bins higher than the minimum specified by the order code without advance notice. Shipments will always adhere to the chromaticity bin restrictions specified by the order code.
- * Flux values @ 25 °C are calculated and for reference only.
- ** Calculated flux values at 700 mA and 1 A are for reference only.

FLUX CHARACTERISTICS - WHITE (T_j = 85 °C) - CONTINUED

Chromaticity		Minimum Luminous Flux @ 350 mA			Calculated Minimum Luminous Flux (lm)** @ 85 °C		Order Codes		
Kit	CCT	Code	Flux (lm) @ 85 °C	Flux (lm) @ 25 °C*	700 mA	1.0 A	70 CRI Typical	75 CRI Typical	80 CRI Minimum
E3	5000 K	R4	130	151	223	284	XPEBWT-01-0000-00GE3		
		R3	122	142	209	266	XPEBWT-01-0000-00FE3	XPEBWT-L1-0000-00FE3	
		R2	114	132	195	249	XPEBWT-01-0000-00EE3	XPEBWT-L1-0000-00EE3	
		Q5	107	124	183	233		XPEBWT-L1-0000-00DE3	
		Q4	100	116	171	218		XPEBWT-L1-0000-00CE3	
F4	4750 K	R4	130	151	223	284	XPEBWT-01-0000-00GF4		
		R3	122	142	209	266	XPEBWT-01-0000-00FF4	XPEBWT-L1-0000-00FF4	
		R2	114	132	195	249	XPEBWT-01-0000-00EF4	XPEBWT-L1-0000-00EF4	
		Q5	107	124	183	233		XPEBWT-L1-0000-00DF4	
		Q4	100	116	171	218		XPEBWT-L1-0000-00CF4	
E4	4500 K	R4	130	151	223	284	XPEBWT-01-0000-00GE4		
		R3	122	142	209	266	XPEBWT-01-0000-00FE4	XPEBWT-L1-0000-00FE4	
		R2	114	132	195	249	XPEBWT-01-0000-00EE4	XPEBWT-L1-0000-00EE4	
		Q5	107	124	183	233		XPEBWT-L1-0000-00DE4	
		Q4	100	116	171	218		XPEBWT-L1-0000-00CE4	
F5	4250 K	R3	122	142	209	266	XPEBWT-01-0000-00FF5		
		R2	114	132	195	249	XPEBWT-01-0000-00EF5	XPEBWT-L1-0000-00EF5	
		Q5	107	124	183	233	XPEBWT-01-0000-00DF5	XPEBWT-L1-0000-00DF5	
		Q4	100	116	171	218		XPEBWT-L1-0000-00CF5	
		Q3	93.9	109	161	205		XPEBWT-L1-0000-00BF5	
E5	4000 K	R3	122	142	209	266	XPEBWT-01-0000-00FE5		
		R2	114	132	195	249	XPEBWT-01-0000-00EE5	XPEBWT-L1-0000-00EE5	XPEBWT-H1-0000-00EE5
		Q5	107	124	183	233	XPEBWT-01-0000-00DE5	XPEBWT-L1-0000-00DE5	XPEBWT-H1-0000-00DE5
		Q4	100	116	171	218		XPEBWT-L1-0000-00CE5	XPEBWT-H1-0000-00CE5
		Q3	93.9	109	161	205		XPEBWT-L1-0000-00BE5	XPEBWT-H1-0000-00BE5
Z5	4000 K	Q5	107	124	183	233		XPEBWT-L1-0000-00DZ5	XPEBWT-H1-0000-00DZ5
		Q4	100	116	171	218		XPEBWT-L1-0000-00CZ5	XPEBWT-H1-0000-00CZ5
		Q3	93.9	109	161	205		XPEBWT-L1-0000-00BZ5	XPEBWT-H1-0000-00BZ5

- Notes:
- Cree maintains a tolerance of ±7% on flux and power measurements, ±0.005 on chromaticity (CCx, CCy) measurements and ±2 on CRI measurements. See the Measurements section (page 39).
 - Cree XLamp XP-E2 LED order codes specify only a minimum flux bin and not a maximum. Cree may ship reels in flux bins higher than the minimum specified by the order code without advance notice. Shipments will always adhere to the chromaticity bin restrictions specified by the order code.
- * Flux values @ 25 °C are calculated and for reference only.
 ** Calculated flux values at 700 mA and 1 A are for reference only.

FLUX CHARACTERISTICS - WHITE ($T_j = 85^\circ\text{C}$) - CONTINUED

Chromaticity		Minimum Luminous Flux @ 350 mA			Calculated Minimum Luminous Flux (lm)** @ 85 °C**		Order Codes					
Kit	CCT	Code	Flux (lm) @ 85 °C	Flux (lm) @ 25 °C*	700 mA	1.0 A	70 CRI Typical	80 CRI Typical	80 CRI Minimum	85 CRI Minimum	90 CRI Minimum	
F6	3750 K	R3	122	142	209	266	XPEBWT-01-0000-00FF6					
		R2	114	132	195	249	XPEBWT-01-0000-00EF6	XPEBWT-L1-0000-00EF6				
		Q5	107	124	183	233	XPEBWT-01-0000-00DF6	XPEBWT-L1-0000-00DF6	XPEBWT-H1-0000-00DF6			
		Q4	100	116	171	218		XPEBWT-L1-0000-00CF6	XPEBWT-H1-0000-00CF6			
		Q3	93.9	109	161	205		XPEBWT-L1-0000-00BF6	XPEBWT-H1-0000-00BF6			
		Q2	87.4	102	150	191		XPEBWT-L1-0000-00AF6	XPEBWT-H1-0000-00AF6			
E6	3500 K	R3	122	142	209	266	XPEBWT-01-0000-00FE6					
		R2	114	132	195	249	XPEBWT-01-0000-00EE6	XPEBWT-L1-0000-00EE6				
		Q5	107	124	183	233	XPEBWT-01-0000-00DE6	XPEBWT-L1-0000-00DE6	XPEBWT-H1-0000-00DE6			
		Q4	100	116	171	218		XPEBWT-L1-0000-00CE6	XPEBWT-H1-0000-00CE6			
		Q3	93.9	109	161	205		XPEBWT-L1-0000-00BE6	XPEBWT-H1-0000-00BE6			
		Q2	87.4	102	150	191		XPEBWT-L1-0000-00AE6	XPEBWT-H1-0000-00AE6			
Z6	3500 K	Q5	107	124	183	233		XPEBWT-L1-0000-00DZ6				
		Q4	100	116	171	218		XPEBWT-L1-0000-00CZ6	XPEBWT-H1-0000-00CZ6			
		Q3	93.9	109	161	205		XPEBWT-L1-0000-00BZ6	XPEBWT-H1-0000-00BZ6			
		Q2	87.4	102	150	191		XPEBWT-L1-0000-00AZ6	XPEBWT-H1-0000-00AZ6			
F7	3250 K	R2	114	132	195	249	XPEBWT-01-0000-00EF7	XPEBWT-L1-0000-00EF7				
		Q5	107	124	183	233	XPEBWT-01-0000-00DF7	XPEBWT-L1-0000-00DF7	XPEBWT-H1-0000-00DF7			
		Q4	100	116	171	218		XPEBWT-L1-0000-00CF7	XPEBWT-H1-0000-00CF7			
		Q3	93.9	109	161	205		XPEBWT-L1-0000-00BF7	XPEBWT-H1-0000-00BF7			
		Q2	87.4	102	150	191		XPEBWT-L1-0000-00AF7	XPEBWT-H1-0000-00AF7			

Notes:

- Cree maintains a tolerance of $\pm 7\%$ on flux and power measurements, ± 0.005 on chromaticity (CCx, CCy) measurements and ± 2 on CRI measurements. See the Measurements section (page 39).
- Cree XLamp XP-E2 LED order codes specify only a minimum flux bin and not a maximum. Cree may ship reels in flux bins higher than the minimum specified by the order code without advance notice. Shipments will always adhere to the chromaticity bin restrictions specified by the order code.
- * Flux values @ 25 °C are calculated and for reference only.
- ** Calculated flux values at 700 mA and 1 A are for reference only.

FLUX CHARACTERISTICS - WHITE ($T_j = 85^\circ\text{C}$) - CONTINUED

Chromaticity		Minimum Luminous Flux @ 350 mA			Calculated Minimum Luminous Flux (lm)** @ 85 °C**		Order Codes				
Kit	CCT	Code	Flux (lm) @ 85 °C	Flux (lm) @ 25 °C*	700 mA	1.0 A	70 CRI Typical	80 CRI Typical	80 CRI Minimum	85 CRI Minimum	90 CRI Minimum
E7	3000 K	R2	114	132	195	249	XPEBWT-01-0000-00EE7	XPEBWT-L1-0000-00EE7			
		Q5	107	124	183	233	XPEBWT-01-0000-00DE7	XPEBWT-L1-0000-00DE7	XPEBWT-H1-0000-00DE7		
		Q4	100	116	171	218		XPEBWT-L1-0000-00CE7	XPEBWT-H1-0000-00CE7		
		Q3	93.9	109	161	205		XPEBWT-L1-0000-00BE7	XPEBWT-H1-0000-00BE7		
		Q2	87.4	102	150	191		XPEBWT-L1-0000-00AE7	XPEBWT-H1-0000-00AE7	XPEBWT-P1-0000-00AE7	XPEBWT-U1-0000-00AE7
		P4	80.6	93.6	138	176				XPEBWT-P1-0000-009E7	XPEBWT-U1-0000-009E7
		P3	73.9	85.8	127	161				XPEBWT-P1-0000-008E7	XPEBWT-U1-0000-008E7
		P2	67.2	78.0	115	147				XPEBWT-P1-0000-007E7	XPEBWT-U1-0000-007E7
Z7	3000 K	Q5	107	124	183	233		XPEBWT-L1-0000-00DZ7			
		Q4	100	116	171	218		XPEBWT-L1-0000-00CZ7	XPEBWT-H1-0000-00CZ7		
		Q3	93.9	109	161	205		XPEBWT-L1-0000-00BZ7	XPEBWT-H1-0000-00BZ7		
		Q2	87.4	102	150	191		XPEBWT-L1-0000-00AZ7	XPEBWT-H1-0000-00AZ7	XPEBWT-P1-0000-00AZ7	
		P4	80.6	93.6	138	176				XPEBWT-P1-0000-009Z7	XPEBWT-U1-0000-009Z7
		P3	73.9	85.8	127	161				XPEBWT-P1-0000-008Z7	XPEBWT-U1-0000-008Z7
		P2	67.2	78.0	115	147				XPEBWT-P1-0000-007Z7	XPEBWT-U1-0000-007Z7

Notes:

- Cree maintains a tolerance of $\pm 7\%$ on flux and power measurements, ± 0.005 on chromaticity (CCx, CCy) measurements and ± 2 on CRI measurements. See the Measurements section (page 39).
 - Cree XLamp XP-E2 LED order codes specify only a minimum flux bin and not a maximum. Cree may ship reels in flux bins higher than the minimum specified by the order code without advance notice. Shipments will always adhere to the chromaticity bin restrictions specified by the order code.
- * Flux values @ 25 °C are calculated and for reference only.
 ** Calculated flux values at 700 mA and 1 A are for reference only.

FLUX CHARACTERISTICS - WHITE ($T_j = 85\text{ }^\circ\text{C}$) - CONTINUED

Chromaticity		Minimum Luminous Flux @ 350 mA			Calculated Minimum Luminous Flux (lm)** @ 85 °C**		Order Codes					
Kit	CCT	Code	Flux (lm) @ 85 °C	Flux (lm) @ 25 °C*	700 mA	1.0 A	70 CRI Typical	80 CRI Typical	80 CRI Minimum	85 CRI Minimum	90 CRI Minimum	
F8	2850 K	Q5	107	124	183	233		XPEBWT-L1-0000-00DF8				
		Q4	100	116	171	218		XPEBWT-L1-0000-00CF8	XPEBWT-H1-0000-00CF8			
		Q3	93.9	109	161	205		XPEBWT-L1-0000-00BF8	XPEBWT-H1-0000-00BF8			
		Q2	87.4	102	150	191		XPEBWT-L1-0000-00AF8	XPEBWT-H1-0000-00AF8	XPEBWT-P1-0000-00AF8		
		P4	80.6	93.6	138	176		XPEBWT-L1-0000-009F8	XPEBWT-H1-0000-009F8	XPEBWT-P1-0000-009F8	XPEBWT-U1-0000-009F8	
		P3	73.9	85.8	127	161					XPEBWT-P1-0000-008F8	XPEBWT-U1-0000-008F8
		P2	67.2	78	115	147					XPEBWT-P1-0000-007F8	XPEBWT-U1-0000-007F8
		N4	62	72	106	135					XPEBWT-P1-0000-006F8	XPEBWT-U1-0000-006F8
E8	2700 K	Q5	107	124	183	233		XPEBWT-L1-0000-00DE8				
		Q4	100	116	171	218		XPEBWT-L1-0000-00CE8	XPEBWT-H1-0000-00CE8			
		Q3	93.9	109	161	205		XPEBWT-L1-0000-00BE8	XPEBWT-H1-0000-00BE8			
		Q2	87.4	102	150	191		XPEBWT-L1-0000-00AE8	XPEBWT-H1-0000-00AE8			
		P4	80.6	93.6	138	176		XPEBWT-L1-0000-009E8	XPEBWT-H1-0000-009E8	XPEBWT-P1-0000-009E8	XPEBWT-U1-0000-009E8	
		P3	73.9	85.8	127	161					XPEBWT-P1-0000-008E8	XPEBWT-U1-0000-008E8
		P2	67.2	78	115	147					XPEBWT-P1-0000-007E8	XPEBWT-U1-0000-007E8
		N4	62	72	106	135					XPEBWT-P1-0000-006E8	XPEBWT-U1-0000-006E8

Notes:

- Cree maintains a tolerance of $\pm 7\%$ on flux and power measurements, ± 0.005 on chromaticity (CCx, CCy) measurements and ± 2 on CRI measurements. See the Measurements section (page 39).
 - Cree XLamp XP-E2 LED order codes specify only a minimum flux bin and not a maximum. Cree may ship reels in flux bins higher than the minimum specified by the order code without advance notice. Shipments will always adhere to the chromaticity bin restrictions specified by the order code.
- * Flux values @ 25 °C are calculated and for reference only.
 ** Calculated flux values at 700 mA and 1 A are for reference only.

FLUX CHARACTERISTICS - WHITE ($T_j = 85\text{ }^\circ\text{C}$) - CONTINUED

Chromaticity		Minimum Luminous Flux @ 350 mA			Calculated Minimum Luminous Flux (lm)** @ 85 °C**		Order Codes					
Kit	CCT	Code	Flux (lm) @ 85 °C	Flux (lm) @ 25 °C*	700 mA	1.0 A	70 CRI Typical	80 CRI Typical	80 CRI Minimum	85 CRI Minimum	90 CRI Minimum	
Z8	2700 K	Q4	100	116	171	218		XPEBWT-L1-0000-00CZ8				
		Q3	93.9	109	161	205		XPEBWT-L1-0000-00BZ8	XPEBWT-H1-0000-00BZ8			
		Q2	87.4	102	150	191		XPEBWT-L1-0000-00AZ8	XPEBWT-H1-0000-00AZ8			
		P4	80.6	93.6	138	176		XPEBWT-L1-0000-009Z8	XPEBWT-H1-0000-009Z8	XPEBWT-P1-0000-009Z8		
		P3	73.9	85.8	127	161					XPEBWT-P1-0000-008Z8	XPEBWT-U1-0000-008Z8
		P2	67.2	78	115	147					XPEBWT-P1-0000-007Z8	XPEBWT-U1-0000-007Z8
		N4	62	72	106	135					XPEBWT-P1-0000-006Z8	XPEBWT-U1-0000-006Z8
EA	2200 K	P3	73.9	85.8	127	161		XPEBWT-L1-0000-008EA	XPEBWT-H1-0000-008EA			
		P2	67.2	78	115	147		XPEBWT-L1-0000-007EA	XPEBWT-H1-0000-007EA			
		N4	62	72	106	135		XPEBWT-L1-0000-006EA	XPEBWT-H1-0000-006EA			
ZA	2200 K	P3	73.9	85.8	127	161		XPEBWT-L1-0000-008ZA	XPEBWT-H1-0000-008ZA			
		P2	67.2	78	115	147		XPEBWT-L1-0000-007ZA	XPEBWT-H1-0000-007ZA			
		N4	62	72	106	135		XPEBWT-L1-0000-006ZA	XPEBWT-H1-0000-006ZA			

Notes:

- Cree maintains a tolerance of $\pm 7\%$ on flux and power measurements, ± 0.005 on chromaticity (CCx, CCy) measurements and ± 2 on CRI measurements. See the Measurements section (page 39).
- Cree XLamp XP-E2 LED order codes specify only a minimum flux bin and not a maximum. Cree may ship reels in flux bins higher than the minimum specified by the order code without advance notice. Shipments will always adhere to the chromaticity bin restrictions specified by the order code.
- * Flux values @ 25 °C are calculated and for reference only.
- ** Calculated flux values at 700 mA and 1 A are for reference only.

FLUX CHARACTERISTICS - COLOR ($T_j = 25\text{ }^\circ\text{C}$)

The following tables provide order codes for XLamp XP-E2 color LEDs. For a complete description of the order-code nomenclature, please see the Bin and Order Code Formats section (page 37).

Color	Minimum Radiant Flux @ 350 mA		Calculated Minimum PPF ($\mu\text{mol/s}$)*	Dominant Wavelength (nm)				Order Codes
	Group	Flux (mW)		Minimum		Maximum		
				Group	DWL (nm)	Group	DWL (nm)	
Royal Blue	30	450	1.71	D3	450	D5	465	XPEBRY-L1-0000-00J01
				D3	450	D4	460	XPEBRY-L1-0000-00J02
				D4	455	D5	465	XPEBRY-L1-0000-00J03
	31	475	1.80	D3	450	D5	465	XPEBRY-L1-0000-00K01
				D3	450	D4	460	XPEBRY-L1-0000-00K02
				D4	455	D5	465	XPEBRY-L1-0000-00K03
	32	500	1.90	D3	450	D5	465	XPEBRY-L1-0000-00L01
				D3	450	D4	460	XPEBRY-L1-0000-00L02
				D4	455	D5	465	XPEBRY-L1-0000-00L03
	33	525	1.99	D3	450	D5	465	XPEBRY-L1-0000-00M01
				D3	450	D4	460	XPEBRY-L1-0000-00M02
				D4	455	D5	465	XPEBRY-L1-0000-00M03
	34	550	2.08	D3	450	D5	465	XPEBRY-L1-0000-00N01
				D3	450	D4	460	XPEBRY-L1-0000-00N02
				D4	455	D5	465	XPEBRY-L1-0000-00N03
	35	575	2.18	D3	450	D5	465	XPEBRY-L1-0000-00P01
				D3	450	D4	460	XPEBRY-L1-0000-00P02
				D4	455	D5	465	XPEBRY-L1-0000-00P03
	36	600	2.27	D3	450	D5	465	XPEBRY-L1-0000-00Q01
				D3	450	D4	460	XPEBRY-L1-0000-00Q02
				D4	455	D5	465	XPEBRY-L1-0000-00Q03
	37	625	2.37	D3	450	D5	465	XPEBRY-L1-0000-00R01
				D3	450	D4	460	XPEBRY-L1-0000-00R02
	38	650	2.46	D3	450	D5	465	XPEBRY-L1-0000-00S01
D3				450	D4	460	XPEBRY-L1-0000-00S02	

Note:

- Cree maintains a tolerance of $\pm 7\%$ on flux and power measurements, ± 0.005 on chromaticity (CC_x , CC_y) measurements, ± 2 on CRI measurements and ± 1 on dominant wavelength measurements. See the Measurements section (page 39).
- Cree XLamp XP-E2 LED order codes specify only a minimum flux bin and not a maximum. Cree may ship reels in flux bins higher than the minimum specified by the order code without advance notice. Shipments will always adhere to the chromaticity bin restrictions specified by the order code.
- * Calculated Photosynthetic Photon Flux (PPF) values are for reference only.

FLUX CHARACTERISTICS - COLOR (T_j = 25 °C) - CONTINUED

Color	Minimum Luminous Flux (lm) @ 350 mA		Dominant Wavelength (nm)				Order Codes
			Minimum		Maximum		
	Group	Flux (lm)	Group	DWL (nm)	Group	DWL (nm)	
Blue	K2	30.6	B3	465	B6	485	XPEBBL-L1-0000-00Y01
			B3	465	B5	480	XPEBBL-L1-0000-00Y02
			B4	470	B5	480	XPEBBL-L1-0000-00Y05
	K3	35.2	B3	465	B6	485	XPEBBL-L1-0000-00Z01
			B3	465	B5	480	XPEBBL-L1-0000-00Z02
			B4	470	B5	480	XPEBBL-L1-0000-00Z05
	M2	39.8	B3	465	B6	485	XPEBBL-L1-0000-00201
			B3	465	B5	480	XPEBBL-L1-0000-00202
			B4	470	B5	480	XPEBBL-L1-0000-00205
	M3	45.7	B3	465	B6	485	XPEBBL-L1-0000-00301
			B3	465	B5	480	XPEBBL-L1-0000-00302
			B4	470	B5	480	XPEBBL-L1-0000-00305

- Note:
- Cree maintains a tolerance of ±7% on flux and power measurements, ±0.005 on chromaticity (CCx, CCy) measurements, ±2 on CRI measurements and ±1 on dominant wavelength measurements. See the Measurements section (page 39).
 - Cree XLamp XP-E2 LED order codes specify only a minimum flux bin and not a maximum. Cree may ship reels in flux bins higher than the minimum specified by the order code without advance notice. Shipments will always adhere to the chromaticity bin restrictions specified by the order code.

FLUX CHARACTERISTICS - COLOR (T_J = 25 °C) - CONTINUED

Color	Minimum Luminous Flux (lm) @ 350 mA		Calculated Minimum PPF (μmol/s)*	Dominant Wavelength (nm)				Order Codes
	Group	Flux (lm)		Minimum		Maximum		
				Group	DWL (nm)	Group	DWL (nm)	
Green	Q2	87.4	0.80	G2	520	G4	535	XPEBGR-L1-0000-00A01
				G2	520	G3	530	XPEBGR-L1-0000-00A02
				G3	525	G4	535	XPEBGR-L1-0000-00A03
	Q3	93.9	0.86	G2	520	G4	535	XPEBGR-L1-0000-00B01
				G2	520	G3	530	XPEBGR-L1-0000-00B02
				G3	525	G4	535	XPEBGR-L1-0000-00B03
	Q4	100	0.91	G2	520	G4	535	XPEBGR-L1-0000-00C01
				G2	520	G3	530	XPEBGR-L1-0000-00C02
				G3	525	G4	535	XPEBGR-L1-0000-00C03
	Q5	107	0.98	G2	520	G4	535	XPEBGR-L1-0000-00D01
				G2	520	G3	530	XPEBGR-L1-0000-00D02
				G3	525	G4	535	XPEBGR-L1-0000-00D03
	R2	114	1.04	G2	520	G4	535	XPEBGR-L1-0000-00E01
				G2	520	G3	530	XPEBGR-L1-0000-00E02
				G3	525	G4	535	XPEBGR-L1-0000-00E03
	R3	122	1.11	G2	520	G4	535	XPEBGR-L1-0000-00F01
				G2	520	G3	530	XPEBGR-L1-0000-00F02
				G3	525	G4	535	XPEBGR-L1-0000-00F03
	R4	130	1.18	G2	520	G4	535	XPEBGR-L1-0000-00G01
				G2	520	G3	530	XPEBGR-L1-0000-00G02
				G3	525	G4	535	XPEBGR-L1-0000-00G03

Color	Color Bin	Minimum Luminous Flux (lm) @ 350 mA		Order Codes
		Group	Flux (lm)	
PC Amber	Y2	Q2	87.4	XPEBPA-L1-0000-00A01
		Q3	93.9	XPEBPA-L1-0000-00B01
		Q4	100	XPEBPA-L1-0000-00C01
		Q5	107	XPEBPA-L1-0000-00D01

- Note:
- Cree maintains a tolerance of ±7% on flux and power measurements, ±0.005 on chromaticity (CC_x, CC_y) measurements, ±2 on CRI measurements and ±1 on dominant wavelength measurements. See the Measurements section (page 39).
 - Cree XLamp XP-E2 LED order codes specify only a minimum flux bin and not a maximum. Cree may ship reels in flux bins higher than the minimum specified by the order code without advance notice. Shipments will always adhere to the chromaticity bin restrictions specified by the order code.
 - * Calculated Photosynthetic Photon Flux (PPF) values are for reference only.

FLUX CHARACTERISTICS - COLOR ($T_j = 25\text{ }^\circ\text{C}$) - CONTINUED

Color	Minimum Luminous Flux (lm) @ 350 mA		Dominant Wavelength (nm)				Order Codes
			Minimum		Maximum		
	Group	Flux (lm)	Group	DWL (nm)	Group	DWL (nm)	
Amber	N4	62.0	A2	585	A3	595	XPEBAM-L1-0000-00601
			A2	585	A2	590	XPEBAM-L1-0000-00602
			A3	590	A3	595	XPEBAM-L1-0000-00603
	P2	67.2	A2	585	A3	595	XPEBAM-L1-0000-00701
			A2	585	A2	590	XPEBAM-L1-0000-00702
			A3	590	A3	595	XPEBAM-L1-0000-00703
	P3	73.9	A2	585	A3	595	XPEBAM-L1-0000-00801
			A2	585	A2	590	XPEBAM-L1-0000-00802
			A3	590	A3	595	XPEBAM-L1-0000-00803
	P4	80.6	A2	585	A3	595	XPEBAM-L1-0000-00901
			A2	585	A2	590	XPEBAM-L1-0000-00902
			A3	590	A3	595	XPEBAM-L1-0000-00903
	Q2	87.4	A2	585	A3	595	XPEBAM-L1-0000-00A01

- Note:
- Cree maintains a tolerance of $\pm 7\%$ on flux and power measurements, ± 0.005 on chromaticity (CCx, CCy) measurements, ± 2 on CRI measurements and ± 1 on dominant wavelength measurements. See the Measurements section (page 39).
 - Cree XLamp XP-E2 LED order codes specify only a minimum flux bin and not a maximum. Cree may ship reels in flux bins higher than the minimum specified by the order code without advance notice. Shipments will always adhere to the chromaticity bin restrictions specified by the order code.

FLUX CHARACTERISTICS - COLOR ($T_j = 25\text{ }^\circ\text{C}$) - CONTINUED

Color	Minimum Luminous Flux (lm) @ 350 mA		Dominant Wavelength (nm)				Order Codes
			Minimum		Maximum		
	Group	Flux (lm)	Group	DWL (nm)	Group	DWL (nm)	
Red-Orange	P2	67.2	O3	610	O4	620	XPEBRO-L1-0000-00701
			O3	610	O3	615	XPEBRO-L1-0000-00702
			O4	615	O4	620	XPEBRO-L1-0000-00703
	P3	73.9	O3	610	O4	620	XPEBRO-L1-0000-00801
			O3	610	O3	615	XPEBRO-L1-0000-00802
			O4	615	O4	620	XPEBRO-L1-0000-00803
	P4	80.6	O3	610	O4	620	XPEBRO-L1-0000-00901
			O3	610	O3	615	XPEBRO-L1-0000-00902
			O4	615	O4	620	XPEBRO-L1-0000-00903
	Q2	87.4	O3	610	O4	620	XPEBRO-L1-0000-00A01
			O3	610	O3	615	XPEBRO-L1-0000-00A02
			O4	615	O4	620	XPEBRO-L1-0000-00A03
	Q3	93.9	O3	610	O4	620	XPEBRO-L1-0000-00B01
			O3	610	O3	615	XPEBRO-L1-0000-00B02
			O3	615	O4	620	XPEBRO-L1-0000-00B03
	Q4	100	O3	610	O4	620	XPEBRO-L1-0000-00C01
			O3	610	O3	615	XPEBRO-L1-0000-00C02
	Q5	107	O3	610	O4	620	XPEBRO-L1-0000-00D01
			O3	610	O3	615	XPEBRO-L1-0000-00D02

Color	Minimum Luminous Flux (lm) @ 350 mA		Calculated Minimum PPF ($\mu\text{mol/s}$)*	Dominant Wavelength (nm)				Order Codes
				Minimum		Maximum		
	Group	Flux (lm)		Group	DWL (nm)	Group	DWL (nm)	
Red	N3	56.8	1.48	R2	620	R3	630	XPEBRD-L1-0000-00501
				R2	620	R2	625	XPEBRD-L1-0000-00502
	N4	62	1.61	R2	620	R3	630	XPEBRD-L1-0000-00601
				R2	620	R2	625	XPEBRD-L1-0000-00602
	P2	67.2	1.75	R2	620	R3	630	XPEBRD-L1-0000-00701
				R2	620	R2	625	XPEBRD-L1-0000-00702
	P3	73.9	1.92	R2	620	R3	630	XPEBRD-L1-0000-00801
				R2	620	R2	625	XPEBRD-L1-0000-00802
	P4	80.6	2.10	R2	620	R3	630	XPEBRD-L1-0000-00901
				R2	620	R2	625	XPEBRD-L1-0000-00902

- Note:
- Cree maintains a tolerance of $\pm 7\%$ on flux and power measurements, ± 0.005 on chromaticity (CC_x , CC_y) measurements, ± 2 on CRI measurements and ± 1 on dominant wavelength measurements. See the Measurements section (page 39).
 - Cree XLamp XP-E2 LED order codes specify only a minimum flux bin and not a maximum. Cree may ship reels in flux bins higher than the minimum specified by the order code without advance notice. Shipments will always adhere to the chromaticity bin restrictions specified by the order code.
 - * Calculated Photosynthetic Photon Flux (PPF) values are for reference only.

FLUX CHARACTERISTICS - COLOR ($T_j = 25\text{ }^\circ\text{C}$) - CONTINUED

Color	Minimum Radiant Flux (mW) @ 350 mA		Calculated Minimum PPF ($\mu\text{mol/s}$)*	Peak Wavelength (nm)				Color Order Codes
				Minimum		Maximum		
	Group	Flux (mW)		Group	PWL (nm)	Group	PWL (nm)	
Photo Red	29	425	2.3	P2	650	P5	670	XPEBPR-L1-0000-00C01
	30	450	2.5	P2	650	P5	670	XPEBPR-L1-0000-00D01

Color	Minimum Radiant Flux (mW) @ 350 mA		Calculated Minimum PPF _{FR} ($\mu\text{mol/s}$)*	Peak Wavelength (nm)				Color Order Codes
				Minimum		Maximum		
	Group	Flux (mW)		Group	PWL (nm)	Group	PWL (nm)	
Far Red	26	350	2.0	F2	720	F5	740	XPEBFR-L1-0000-00901
	27	375	2.1	F2	720	F5	740	XPEBFR-L1-0000-00A01
	28	400	2.2	F2	720	F5	740	XPEBFR-L1-0000-00B01

Note:

- Cree maintains a tolerance of $\pm 7\%$ on flux and power measurements, ± 0.005 on chromaticity (CCx, CCy) measurements and ± 2 on CRI measurements. See the Measurements section (page 39).
- Cree XLamp XP-E2 LED order codes specify only a minimum flux bin and not a maximum. Cree may ship reels in flux bins higher than the minimum specified by the order code without advance notice. Shipments will always adhere to the chromaticity bin restrictions specified by the order code.
- * Calculated Photosynthetic Photon Flux (PPF) and Far-Red Photon Flux (PPF_{FR}) values are for reference only.

RELATIVE SPECTRAL POWER DISTRIBUTION

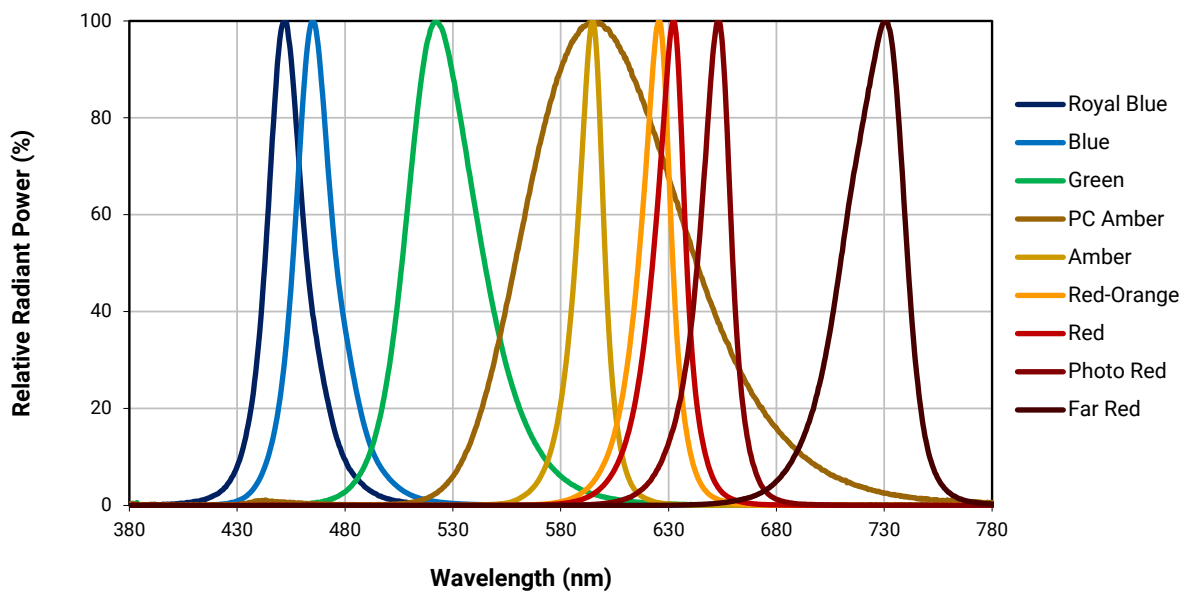
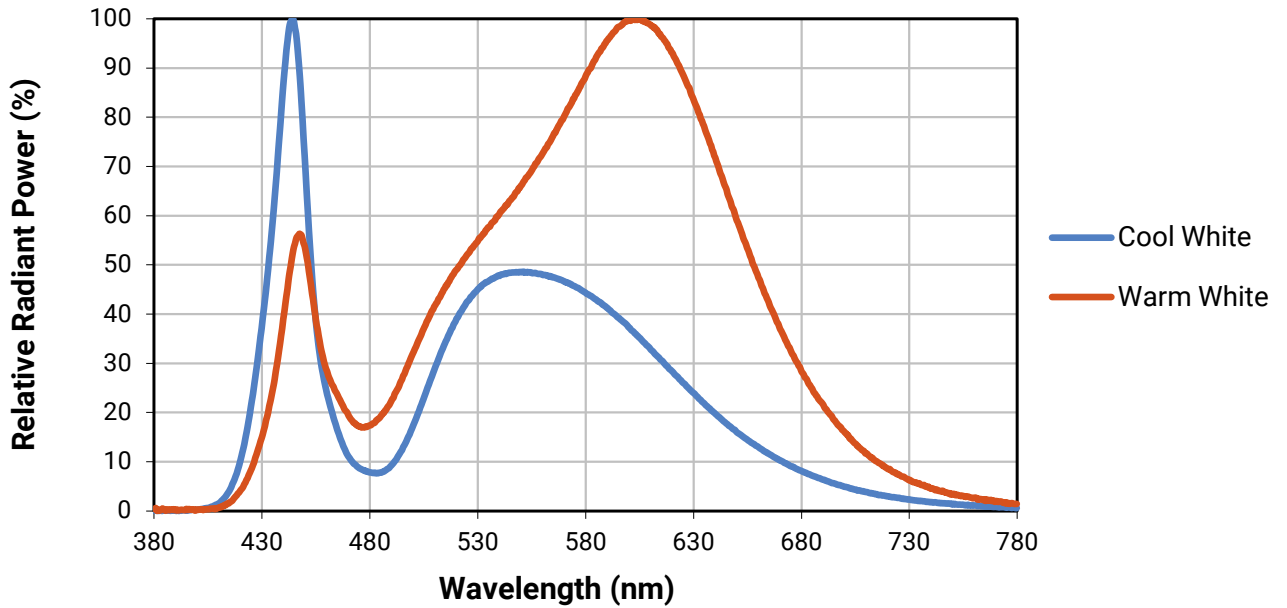

RELATIVE FLUX VS. JUNCTION TEMPERATURE ($I_F = 350$ mA)

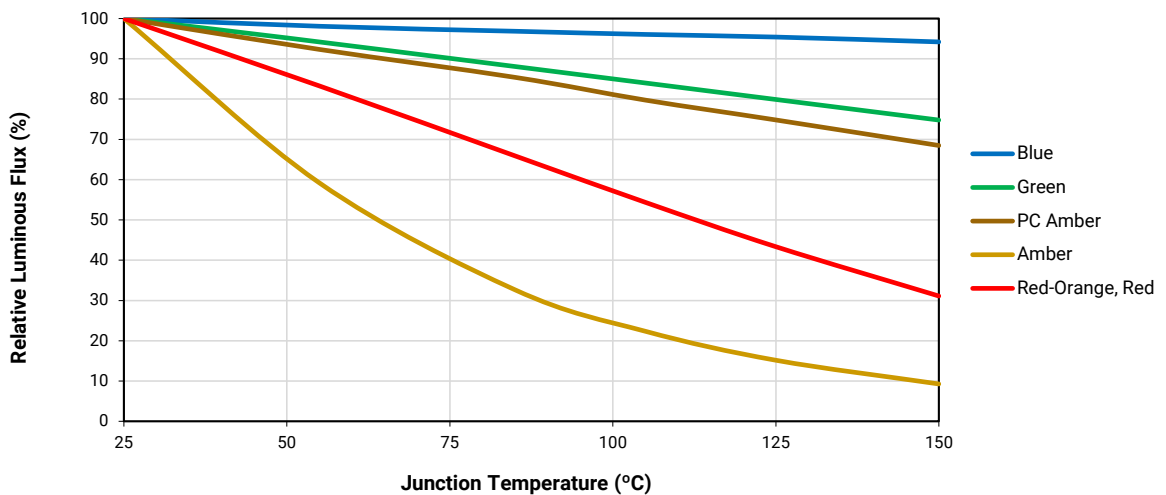
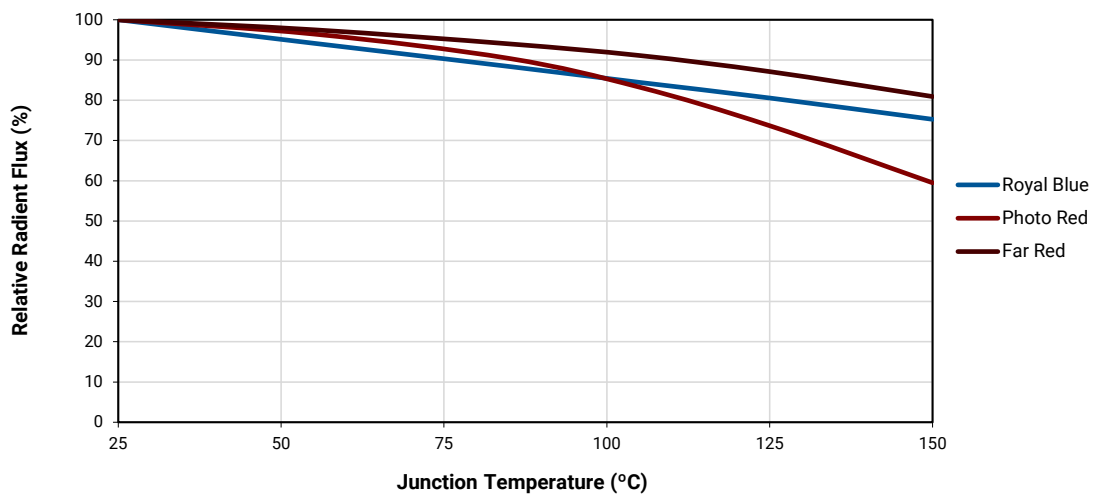
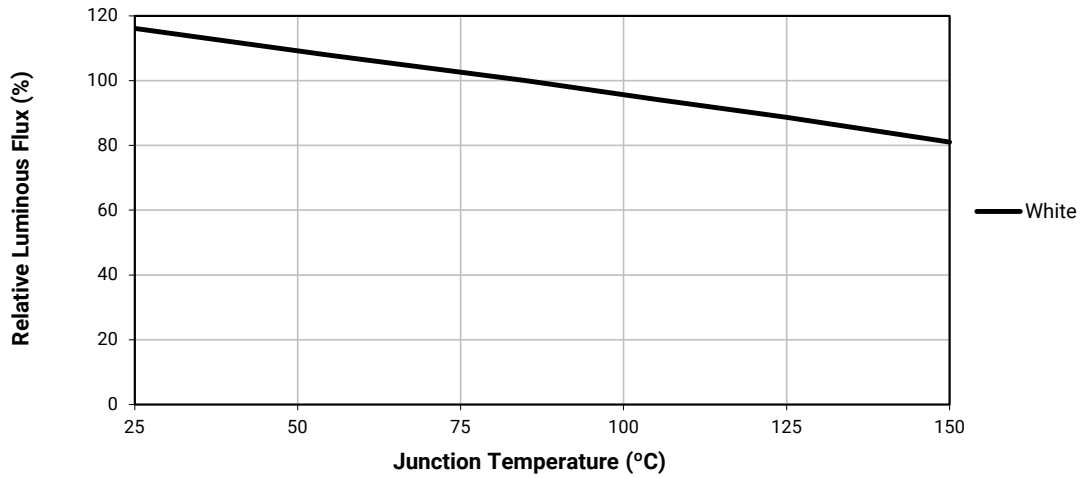

ELECTRICAL CHARACTERISTICS - WHITE ($T_j = 85\text{ }^\circ\text{C}$)

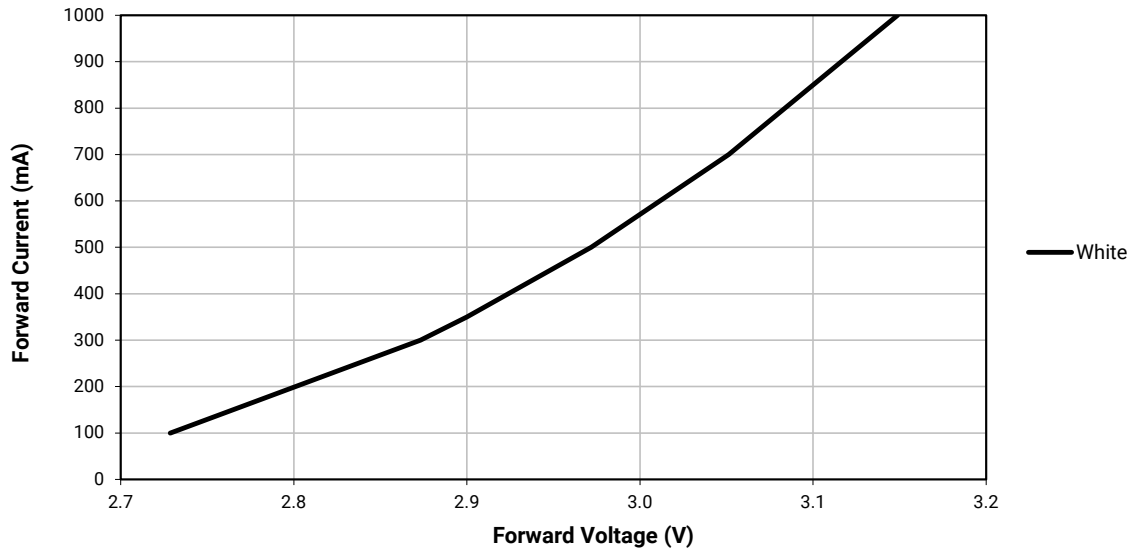

ELECTRICAL CHARACTERISTICS - COLOR ($T_j = 25\text{ }^\circ\text{C}$)

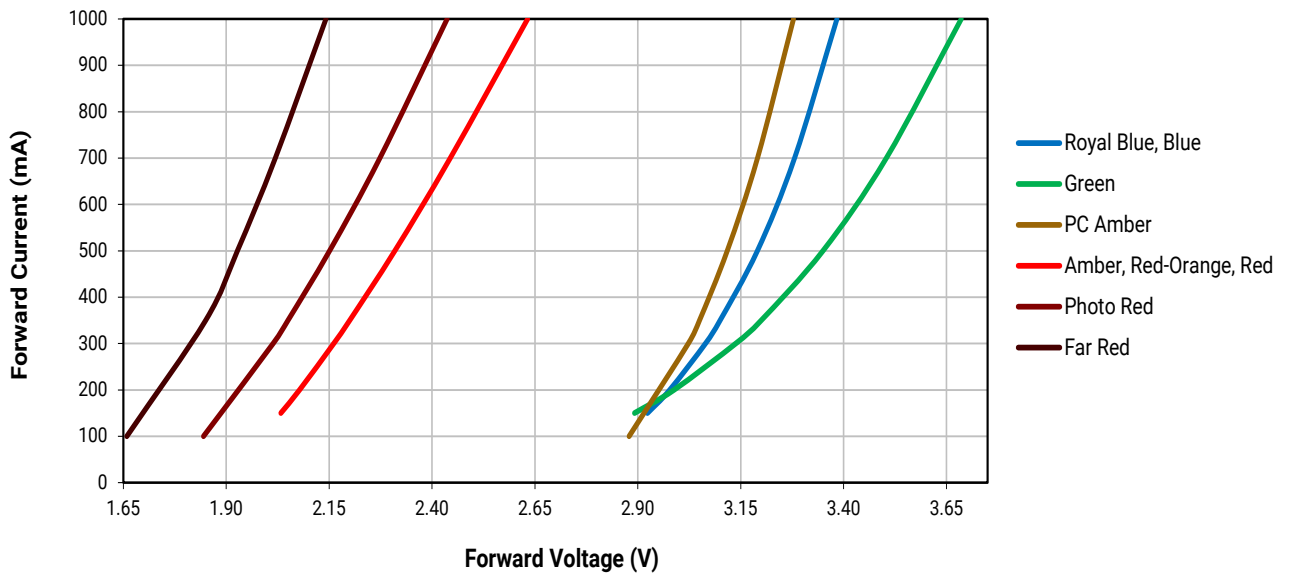

RELATIVE FLUX VS. CURRENT - WHITE ($T_j = 85\text{ }^\circ\text{C}$)

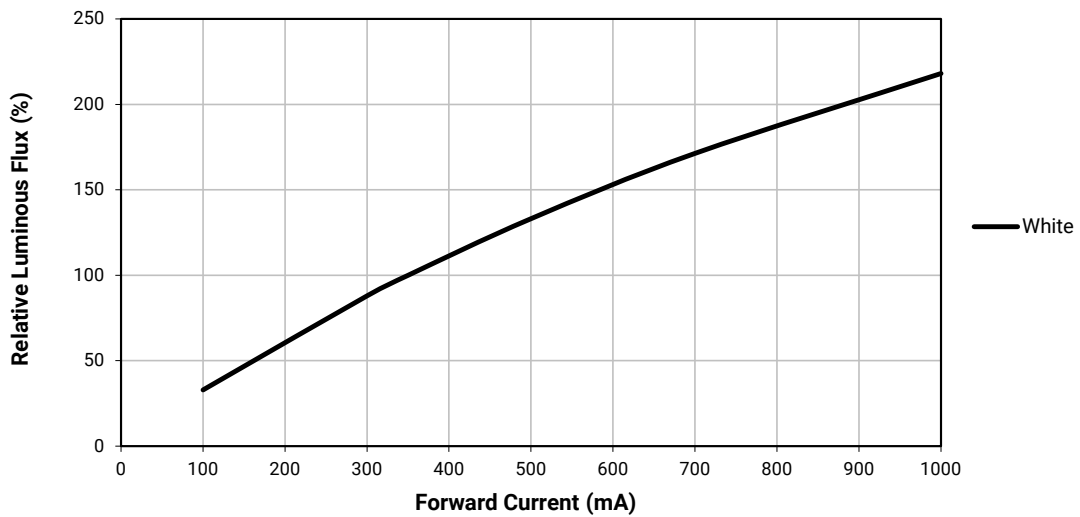

RELATIVE FLUX VS. CURRENT - COLOR ($T_j = 25\text{ }^\circ\text{C}$)

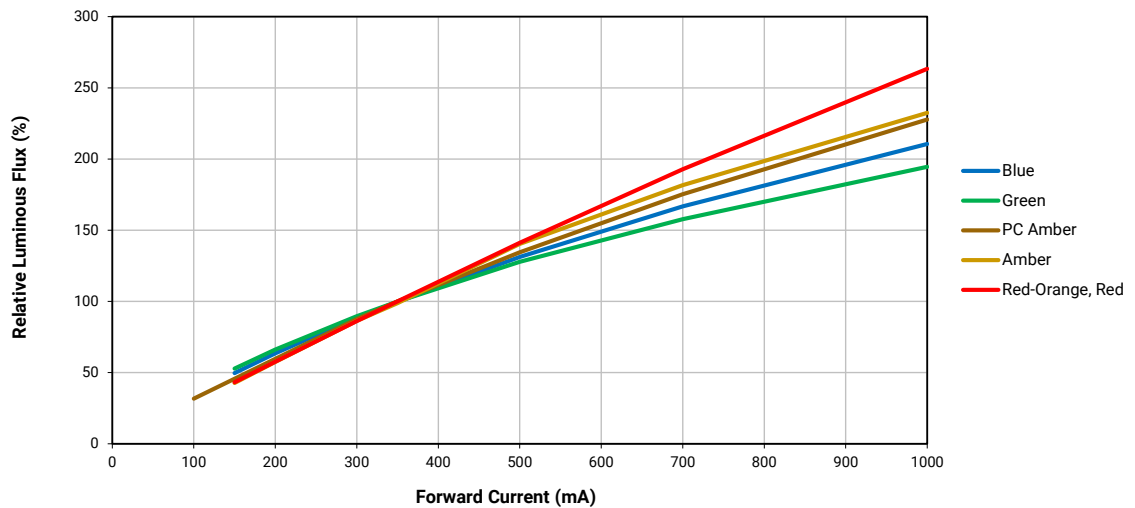
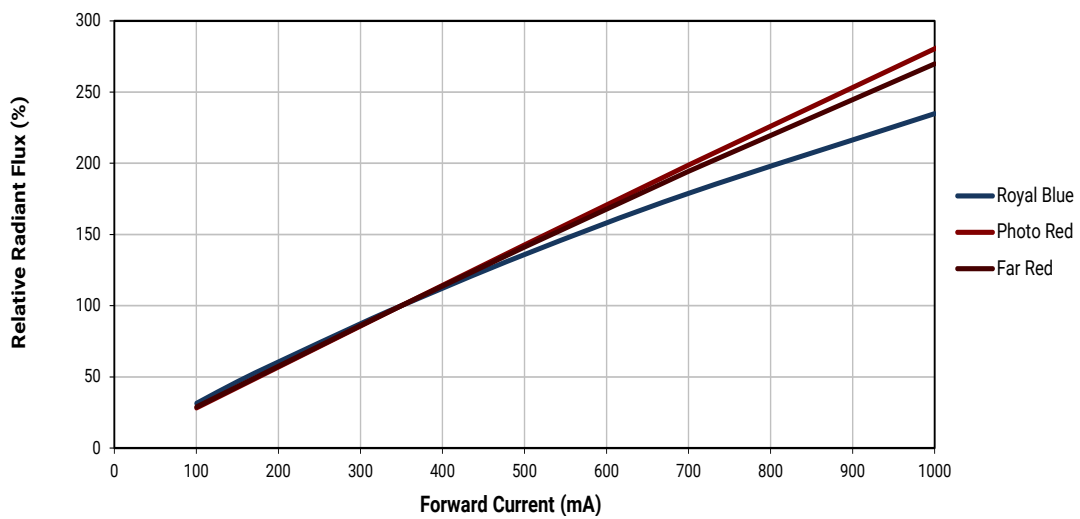

RELATIVE CHROMATICITY VS. CURRENT AND TEMPERATURE - WARM WHITE*

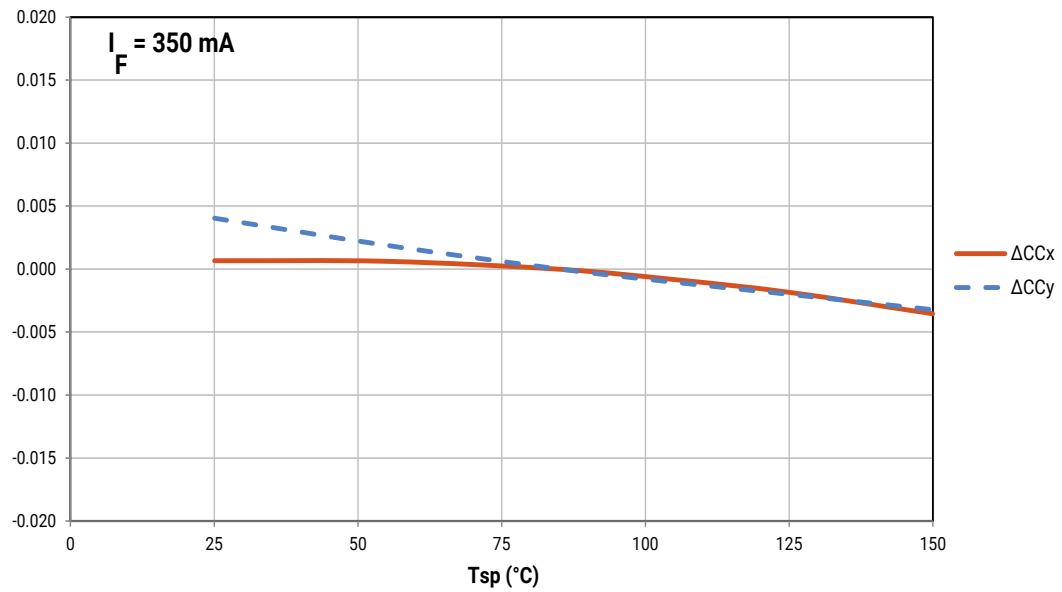
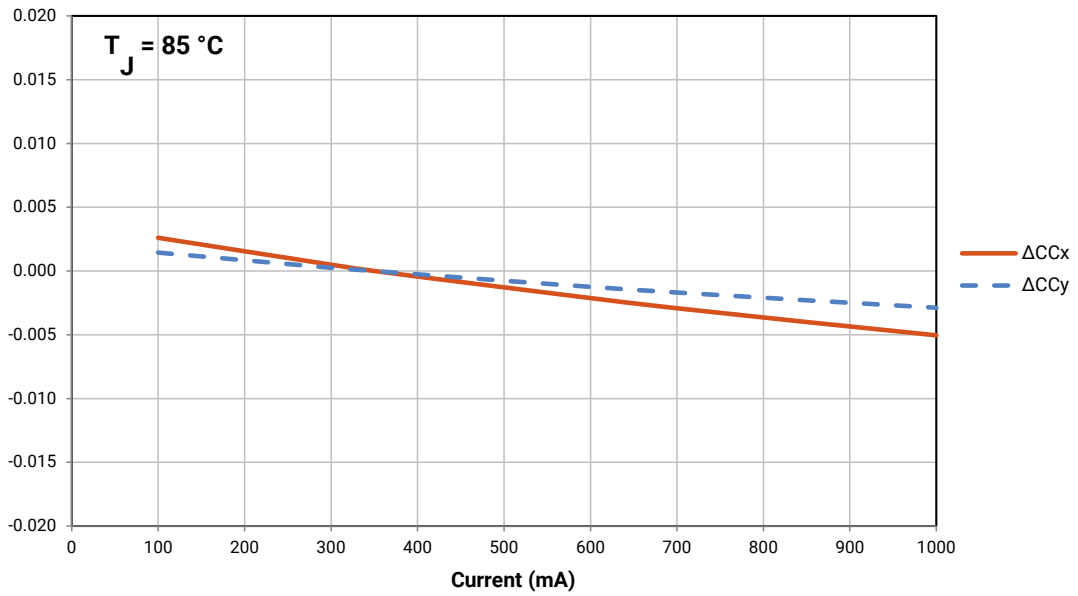

* Warm White XLamp XP-E2 LEDs have a typical CRI of 80.

TYPICAL SPATIAL DISTRIBUTION

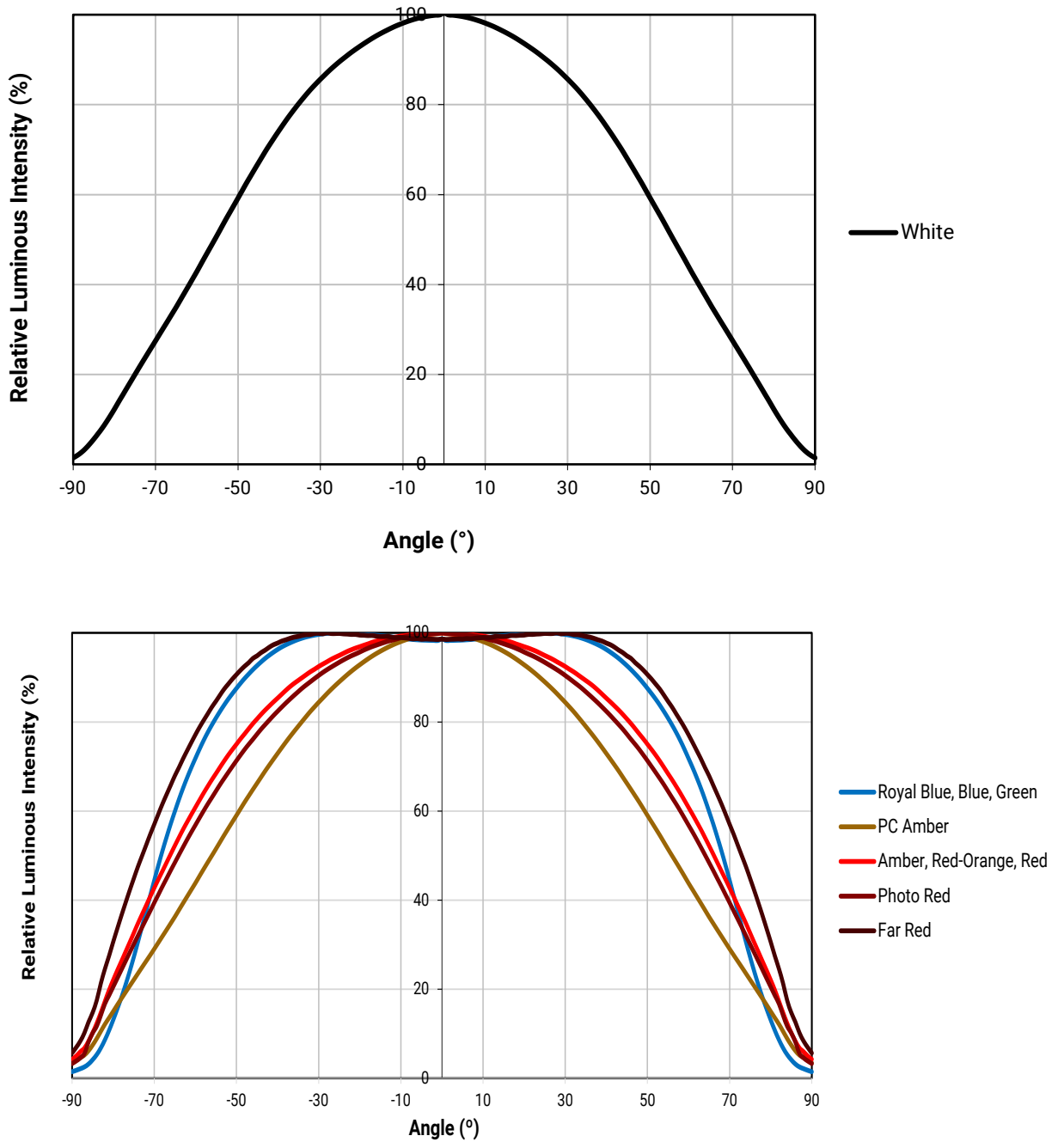

THERMAL DESIGN

The maximum forward current is determined by the thermal resistance between the LED junction and ambient. It is crucial for the end product to be designed in a manner that minimizes the thermal resistance from the solder point to ambient in order to optimize lamp life and optical characteristics.

White

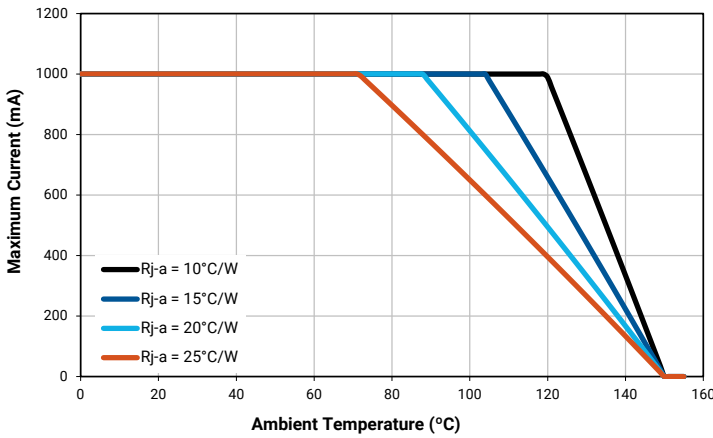

Royal Blue, Blue

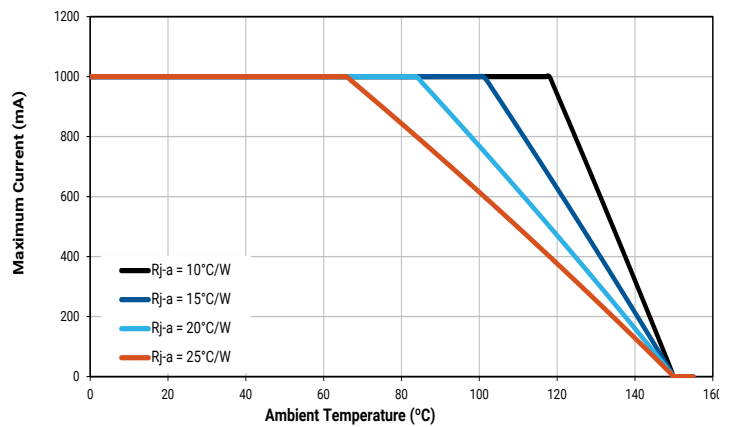

Green

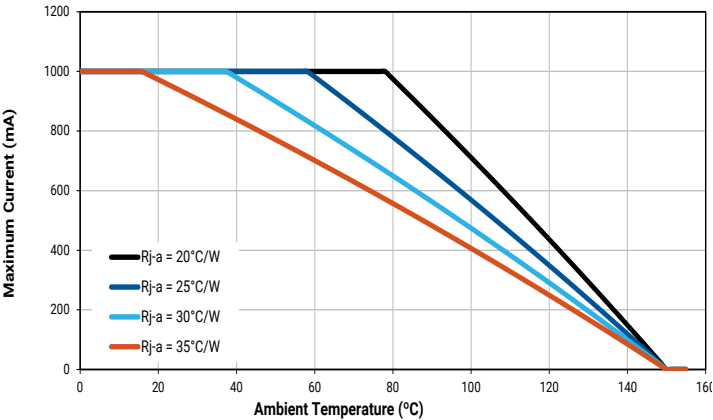

PC Amber

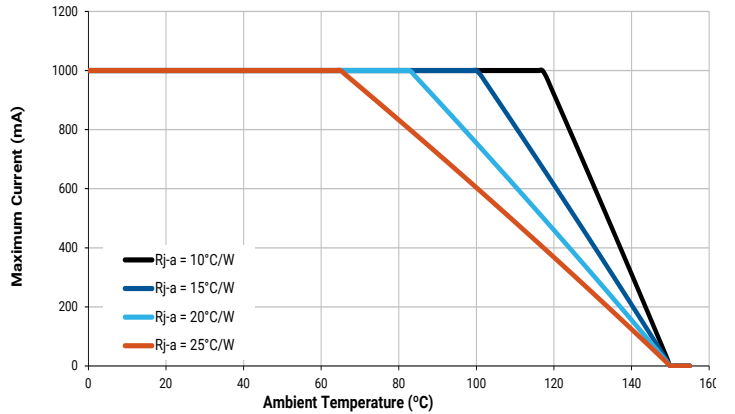

Amber

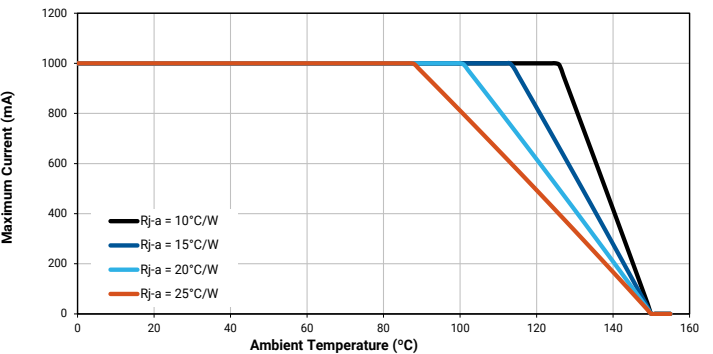

Red-Orange, Red

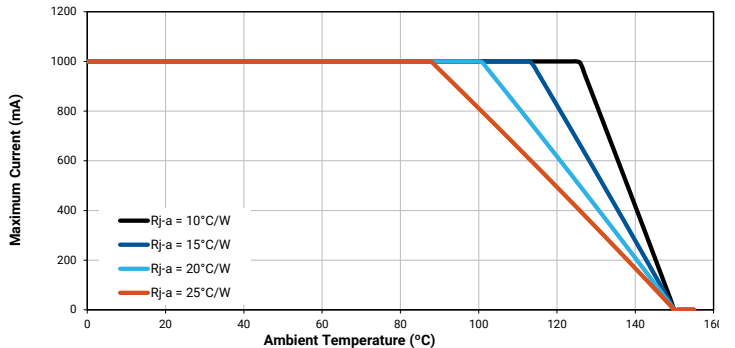

THERMAL DESIGN - CONTINUED

Photo Red

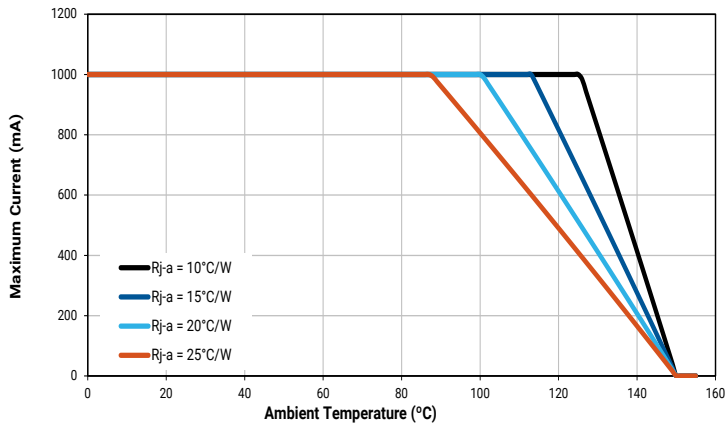

Far Red

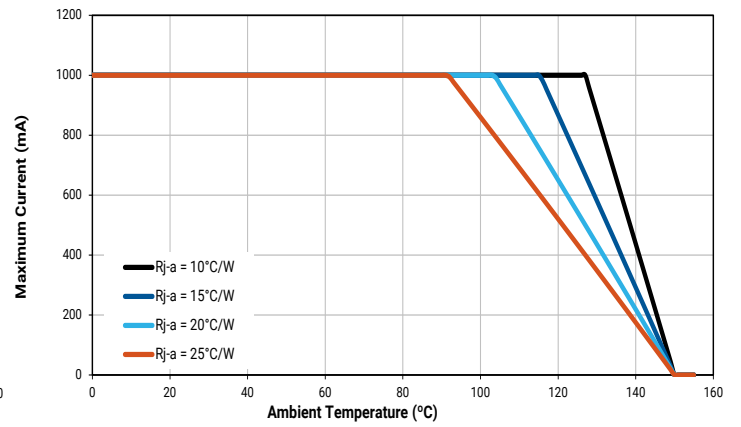

PERFORMANCE GROUPS - LUMINOUS FLUX

XLamp XP-E2 LEDs (except royal blue, photo red and far red) are tested for luminous flux and placed into one of the following luminous-flux groups:

Group Code	Minimum Luminous Flux (lm) @ 350 mA	Maximum Luminous Flux (lm) @ 350 mA
K2	30.6	35.2
K3	35.2	39.8
M2	39.8	45.7
M3	45.7	51.7
N2	51.7	56.8
N3	56.8	62.0
N4	62.0	67.2
P2	67.2	73.9
P3	73.9	80.6
P4	80.6	87.4
Q2	87.4	93.9
Q3	93.9	100
Q4	100	107
Q5	107	114
R2	114	122
R3	122	130
R4	130	139

PERFORMANCE GROUPS - RADIANT FLUX ($T_j = 25\text{ }^\circ\text{C}$)

XLamp XP-E2 royal blue and photo red LEDs are tested for radiant flux and placed into one the following bins:

Group	Minimum Radiant Flux (mW) @ 350 mA	Maximum Radiant Flux (mW) @ 350 mA
29	425	450
30	450	475
31	475	500
32	500	525
33	525	550
34	550	575
35	575	600
36	600	625
37	625	650
38	650	675
39	675	700

XLamp XP-E2 far red LEDs are tested for radiant flux and sorted into one of the following radiant-flux bins:

Group	Minimum Radiant Flux (mW) @ 350 mA	Maximum Radiant Flux (mW) @ 350 mA
26	350	375
27	375	400
28	400	425

PERFORMANCE GROUPS - CHROMATICITY

White XLamp XP-E2 LEDs are tested for chromaticity and placed into one of the regions defined by the bounding coordinates on the following pages.

Region	x	y	Region	x	y	Region	x	y	Region	x	y
0A	0.2950	0.2970	0B	0.2920	0.3060	0C	0.2984	0.3133	0D	0.2984	0.3133
	0.2920	0.3060		0.2895	0.3135		0.2962	0.3220		0.3048	0.3207
	0.2984	0.3133		0.2962	0.3220		0.3028	0.3304		0.3068	0.3113
	0.3009	0.3042		0.2984	0.3133		0.3048	0.3207		0.3009	0.3042
0R	0.2980	0.2880	0S	0.2895	0.3135	0T	0.2962	0.3220	0U	0.3037	0.2937
	0.2950	0.2970		0.2870	0.3210		0.2937	0.3312		0.3009	0.3042
	0.3009	0.3042		0.2937	0.3312		0.3005	0.3415		0.3068	0.3113
	0.3037	0.2937		0.2962	0.3220		0.3028	0.3304		0.3093	0.2993
1A	0.3048	0.3207	1B	0.3028	0.3304	1C	0.3115	0.3391	1D	0.3130	0.3290
	0.3130	0.3290		0.3115	0.3391		0.3205	0.3481		0.3213	0.3373
	0.3144	0.3186		0.3130	0.3290		0.3213	0.3373		0.3221	0.3261
	0.3068	0.3113		0.3048	0.3207		0.3130	0.3290		0.3144	0.3186
1R	0.3068	0.3113	1S	0.3005	0.3415	1T	0.3099	0.3509	1U	0.3144	0.3186
	0.3144	0.3186		0.3099	0.3509		0.3196	0.3602		0.3221	0.3261
	0.3161	0.3059		0.3115	0.3391		0.3205	0.3481		0.3231	0.3120
	0.3093	0.2993		0.3028	0.3304		0.3115	0.3391		0.3161	0.3059
2A	0.3215	0.3350	2B	0.3207	0.3462	2C	0.3290	0.3538	2D	0.3290	0.3417
	0.3290	0.3417		0.3290	0.3538		0.3376	0.3616		0.3371	0.3490
	0.3290	0.3300		0.3290	0.3417		0.3371	0.3490		0.3366	0.3369
	0.3222	0.3243		0.3215	0.3350		0.3290	0.3417		0.3290	0.3300
2R	0.3222	0.3243	2S	0.3196	0.3602	2T	0.3290	0.3690	2U	0.3290	0.3300
	0.3290	0.3300		0.3290	0.3690		0.3381	0.3762		0.3366	0.3369
	0.3290	0.3180		0.3290	0.3538		0.3376	0.3616		0.3361	0.3245
	0.3231	0.3120		0.3207	0.3462		0.3290	0.3538		0.3290	0.3180
3A	0.3371	0.3490	3B	0.3376	0.3616	3C	0.3463	0.3687	3D	0.3451	0.3554
	0.3451	0.3554		0.3463	0.3687		0.3551	0.3760		0.3533	0.3620
	0.3440	0.3427		0.3451	0.3554		0.3533	0.3620		0.3515	0.3487
	0.3366	0.3369		0.3371	0.3490		0.3451	0.3554		0.3440	0.3427
3R	0.3366	0.3369	3S	0.3381	0.3762						
	0.3440	0.3428		0.3480	0.3840						
	0.3429	0.3307		0.3463	0.3687						
	0.3361	0.3245		0.3376	0.3616						
4A	0.3530	0.3597	4B	0.3548	0.3736	4C	0.3641	0.3804	4D	0.3615	0.3659
	0.3615	0.3659		0.3641	0.3804		0.3736	0.3874		0.3702	0.3722
	0.3590	0.3521		0.3615	0.3659		0.3702	0.3722		0.3670	0.3578
	0.3512	0.3465		0.3530	0.3597		0.3615	0.3659		0.3590	0.3521

PERFORMANCE GROUPS - CHROMATICITY (CONTINUED)

Region	x	y	Region	x	y	Region	x	y	Region	x	y
5A1	0.3670	0.3578	5A2	0.3686	0.3649	5A3	0.3744	0.3685	5A4	0.3726	0.3612
	0.3686	0.3649		0.3702	0.3722		0.3763	0.3760		0.3744	0.3685
	0.3744	0.3685		0.3763	0.3760		0.3825	0.3798		0.3804	0.3721
	0.3726	0.3612		0.3744	0.3685		0.3804	0.3721		0.3783	0.3646
5B1	0.3702	0.3722	5B2	0.3719	0.3797	5B3	0.3782	0.3837	5B4	0.3763	0.3760
	0.3719	0.3797		0.3736	0.3874		0.3802	0.3916		0.3782	0.3837
	0.3782	0.3837		0.3802	0.3916		0.3869	0.3958		0.3847	0.3877
	0.3763	0.3760		0.3782	0.3837		0.3847	0.3877		0.3825	0.3798
5C1	0.3825	0.3798	5C2	0.3847	0.3877	5C3	0.3912	0.3917	5C4	0.3887	0.3836
	0.3847	0.3877		0.3869	0.3958		0.3937	0.4001		0.3912	0.3917
	0.3912	0.3917		0.3937	0.4001		0.4006	0.4044		0.3978	0.3958
	0.3887	0.3836		0.3912	0.3917		0.3978	0.3958		0.3950	0.3875
5D1	0.3783	0.3646	5D2	0.3804	0.3721	5D3	0.3863	0.3758	5D4	0.3840	0.3681
	0.3804	0.3721		0.3825	0.3798		0.3887	0.3836		0.3863	0.3758
	0.3863	0.3758		0.3887	0.3836		0.3950	0.3875		0.3924	0.3794
	0.3840	0.3681		0.3863	0.3758		0.3924	0.3794		0.3898	0.3716
6A1	0.3889	0.3690	6A2	0.3915	0.3768	6A3	0.3981	0.3800	6A4	0.3953	0.3720
	0.3915	0.3768		0.3941	0.3848		0.4010	0.3882		0.3981	0.3800
	0.3981	0.3800		0.4010	0.3882		0.4080	0.3916		0.4048	0.3832
	0.3953	0.3720		0.3981	0.3800		0.4048	0.3832		0.4017	0.3751
6B1	0.3941	0.3848	6B2	0.3968	0.3930	6B3	0.4040	0.3966	6B4	0.4010	0.3882
	0.3968	0.3930		0.3996	0.4015		0.4071	0.4052		0.4040	0.3966
	0.4040	0.3966		0.4071	0.4052		0.4146	0.4089		0.4113	0.4001
	0.4010	0.3882		0.4040	0.3966		0.4113	0.4001		0.4080	0.3916
6C1	0.4080	0.3916	6C2	0.4113	0.4001	6C3	0.4186	0.4037	6C4	0.4150	0.3950
	0.4113	0.4001		0.4146	0.4089		0.4222	0.4127		0.4186	0.4037
	0.4186	0.4037		0.4222	0.4127		0.4299	0.4165		0.4259	0.4073
	0.4150	0.3950		0.4186	0.4037		0.4259	0.4073		0.4221	0.3984
6D1	0.4017	0.3751	6D2	0.4048	0.3832	6D3	0.4116	0.3865	6D4	0.4082	0.3782
	0.4048	0.3832		0.4080	0.3916		0.4150	0.3950		0.4116	0.3865
	0.4116	0.3865		0.4150	0.3950		0.4221	0.3984		0.4183	0.3898
	0.4082	0.3782		0.4116	0.3865		0.4183	0.3898		0.4147	0.3814
7A1	0.4147	0.3814	7A2	0.4183	0.3898	7A3	0.4242	0.3919	7A4	0.4203	0.3833
	0.4183	0.3898		0.4221	0.3984		0.4281	0.4006		0.4242	0.3919
	0.4242	0.3919		0.4281	0.4006		0.4342	0.4028		0.4300	0.3939
	0.4203	0.3833		0.4242	0.3919		0.4300	0.3939		0.4259	0.3853
7B1	0.4221	0.3984	7B2	0.4259	0.4073	7B3	0.4322	0.4096	7B4	0.4281	0.4006
	0.4259	0.4073		0.4299	0.4165		0.4364	0.4188		0.4322	0.4096
	0.4322	0.4096		0.4364	0.4188		0.4430	0.4212		0.4385	0.4119
	0.4281	0.4006		0.4322	0.4096		0.4385	0.4119		0.4342	0.4028

PERFORMANCE GROUPS - CHROMATICITY (CONTINUED)

Region	x	y	Region	x	y	Region	x	y	Region	x	y
7C1	0.4342	0.4028	7C2	0.4385	0.4119	7C3	0.4449	0.4141	7C4	0.4403	0.4049
	0.4385	0.4119		0.4430	0.4212		0.4496	0.4236		0.4449	0.4141
	0.4449	0.4141		0.4496	0.4236		0.4562	0.4260		0.4513	0.4164
	0.4403	0.4049		0.4449	0.4141		0.4513	0.4164		0.4465	0.4071
7D1	0.4259	0.3853	7D2	0.4300	0.3939	7D3	0.4359	0.3960	7D4	0.4316	0.3873
	0.4300	0.3939		0.4342	0.4028		0.4403	0.4049		0.4359	0.3960
	0.4359	0.3960		0.4403	0.4049		0.4465	0.4071		0.4418	0.3981
	0.4316	0.3873		0.4359	0.3960		0.4418	0.3981		0.4373	0.3893
8A1	0.4373	0.3893	8A2	0.4418	0.3981	8A3	0.4475	0.3994	8A4	0.4428	0.3906
	0.4418	0.3981		0.4465	0.4071		0.4523	0.4085		0.4475	0.3994
	0.4475	0.3994		0.4523	0.4085		0.4582	0.4099		0.4532	0.4008
	0.4428	0.3906		0.4475	0.3994		0.4532	0.4008		0.4483	0.3919
8B1	0.4465	0.4071	8B2	0.4513	0.4164	8B3	0.4573	0.4178	8B4	0.4523	0.4085
	0.4513	0.4164		0.4562	0.4260		0.4624	0.4274		0.4573	0.4178
	0.4573	0.4178		0.4624	0.4274		0.4687	0.4289		0.4634	0.4193
	0.4523	0.4085		0.4573	0.4178		0.4634	0.4193		0.4582	0.4099
8C1	0.4582	0.4099	8C2	0.4634	0.4193	8C3	0.4695	0.4207	8C4	0.4641	0.4112
	0.4634	0.4193		0.4687	0.4289		0.4750	0.4304		0.4695	0.4207
	0.4695	0.4207		0.4750	0.4304		0.4813	0.4319		0.4756	0.4221
	0.4641	0.4112		0.4695	0.4207		0.4756	0.4221		0.4700	0.4126
8D1	0.4483	0.3919	8D2	0.4532	0.4008	8D3	0.4589	0.4021	8D4	0.4538	0.3931
	0.4532	0.4008		0.4582	0.4099		0.4641	0.4112		0.4589	0.4021
	0.4589	0.4021		0.4641	0.4112		0.4700	0.4126		0.4646	0.4034
	0.4538	0.3931		0.4589	0.4021		0.4646	0.4034		0.4593	0.3944
AA1	0.4822	0.3973	AA2	0.4884	0.4067	AA3	0.4942	0.4066	AA4	0.4879	0.3972
	0.4884	0.4067		0.4946	0.4162		0.5006	0.4160		0.4942	0.4066
	0.4942	0.4066		0.5006	0.4160		0.5066	0.4158		0.5001	0.4064
	0.4879	0.3972		0.4942	0.4066		0.5001	0.4064		0.4936	0.3970
AB1	0.4946	0.4162	AB2	0.5008	0.4256	AB3	0.5069	0.4254	AB4	0.5006	0.4160
	0.5008	0.4256		0.5070	0.4350		0.5133	0.4348		0.5069	0.4254
	0.5069	0.4254		0.5133	0.4348		0.5196	0.4346		0.5131	0.4252
	0.5006	0.4160		0.5069	0.4254		0.5131	0.4252		0.5066	0.4158
AC1	0.5066	0.4158	AC2	0.5131	0.4252	AC3	0.5192	0.4250	AC4	0.5126	0.4156
	0.5131	0.4252		0.5196	0.4346		0.5258	0.4343		0.5192	0.4250
	0.5192	0.4250		0.5258	0.4343		0.5321	0.4341		0.5253	0.4248
	0.5126	0.4156		0.5192	0.4250		0.5253	0.4248		0.5186	0.4154
AD1	0.4936	0.3970	AD2	0.5001	0.4064	AD3	0.5059	0.4062	AD4	0.4993	0.3969
	0.5001	0.4064		0.5066	0.4158		0.5126	0.4156		0.5059	0.4062
	0.5059	0.4062		0.5126	0.4156		0.5186	0.4154		0.5118	0.4061
	0.4993	0.3969		0.5059	0.4062		0.5118	0.4061		0.5050	0.3967

PERFORMANCE GROUPS - CHROMATICITY (CONTINUED)

XLamp XP-E2 PC amber LEDs are placed into the region defined by the following bounding coordinates.

Region	x	y
Y2	0.5469	0.4249
	0.5700	0.4100
	0.5900	0.4100
	0.5610	0.4390

PERFORMANCE GROUPS - DOMINANT WAVELENGTH

Color XLamp XP-E2 LEDs are tested for dominant wavelength (DWL) and sorted into one of the DWL bins defined below.

Color	DWL Group	Minimum DWL (nm) @ 350 mA	Maximum DWL (nm) @ 350 mA
Royal Blue	D3	450	455
	D4	455	460
	D5	460	465
Blue	B3	465	470
	B4	470	475
	B5	475	480
	B6	480	485
Green	G2	520	525
	G3	525	530
	G4	530	535
Amber	A2	585	590
	A3	590	595
Red-Orange	O3	610	615
	O4	615	620
Red	R2	620	625
	R3	625	630

PERFORMANCE GROUPS - PEAK WAVELENGTH

Photo red and far red XLamp XP-E2 LEDs are tested for peak wavelength (PWL) and sorted into one of the PWL bins defined below.

Color	PWL Group	Minimum PWL (nm) @ 350 mA	Maximum PWL (nm) @ 350 mA
Photo Red	P2	650	655
	P3	655	660
	P4	660	665
	P5	665	670
Far Red	F2	720	725
	F3	725	730
	F4	730	735
	F5	735	740

PERFORMANCE GROUPS - FORWARD VOLTAGE

Amber, red-orange, red, photo red and far red XLamp XP-E2 LEDs are tested for forward voltage and sorted into one of the forward voltage bins defined below.

Forward Voltage Group	Minimum Forward Voltage (V) @ 350 mA	Maximum Forward Voltage (V) @ 350 mA
A	1.5	1.75
B	1.75	2.0
C	2.0	2.25
D	2.25	2.5
E	2.5	2.75
F	2.75	3.0
G	3.0	3.25
H	3.25	3.5
J	3.5	3.75

CREE'S STANDARD CHROMATICITY REGIONS PLOTTED ON THE 1931 CIE CURVE

ANSI Cool White

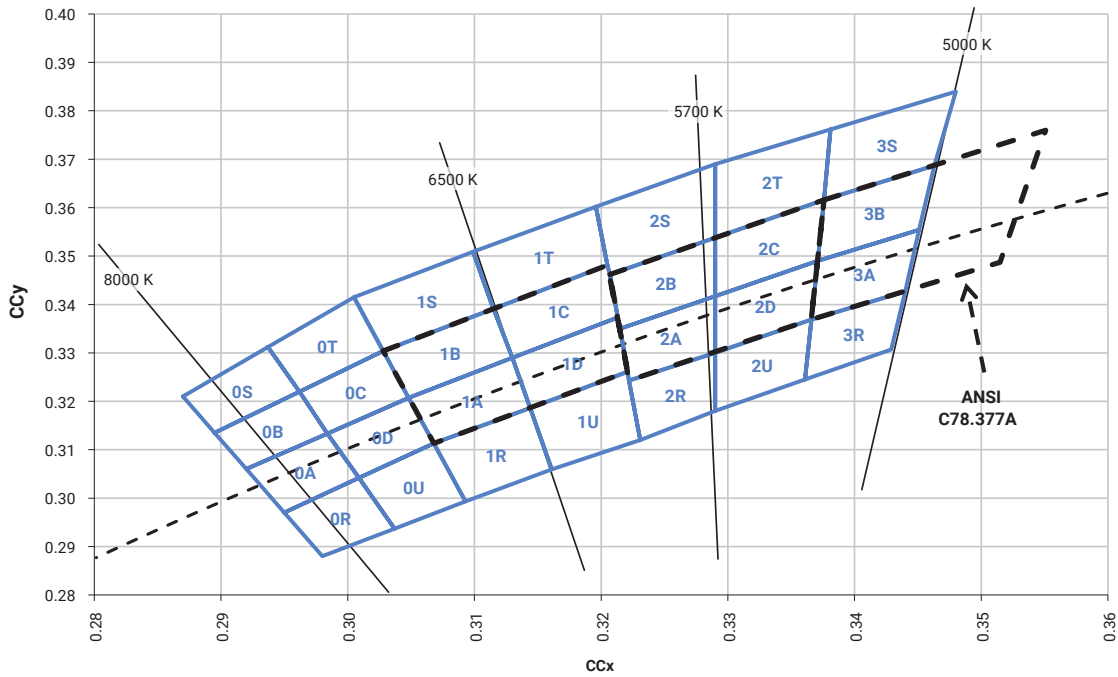

ANSI Neutral White and ANSI Warm White

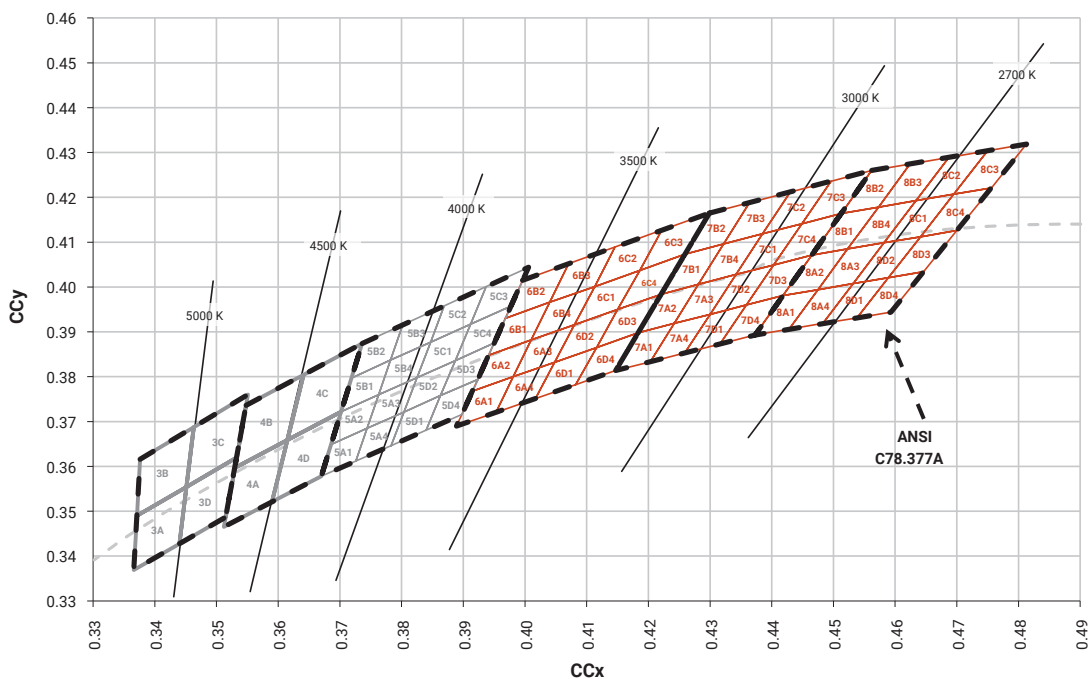

CREE'S STANDARD COOL WHITE KITS PLOTTED ON ANSI STANDARD CHROMATICITY REGIONS

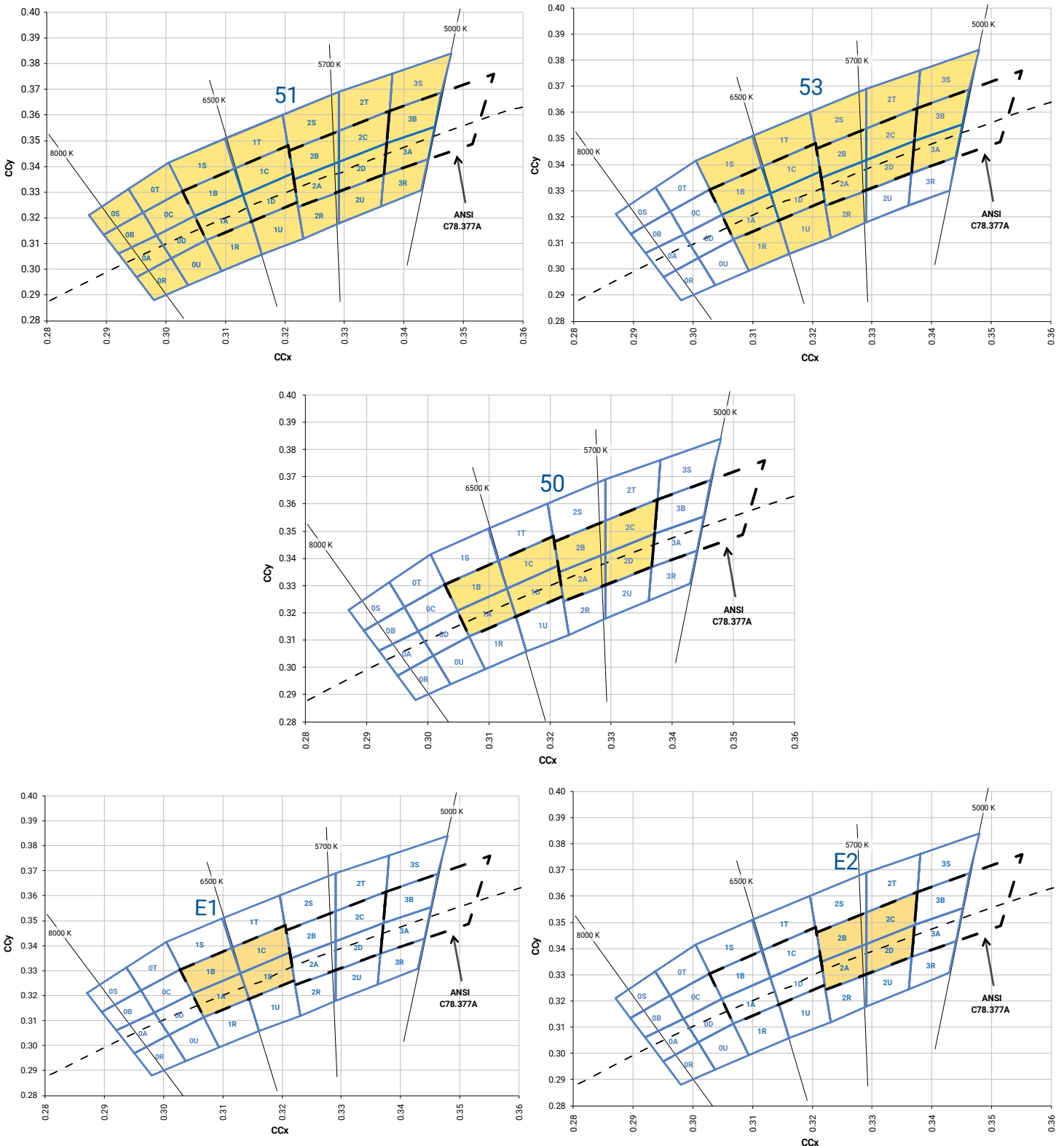

CREE'S STANDARD WARM AND NEUTRAL WHITE KITS PLOTTED ON ANSI STANDARD CHROMATICITY REGIONS

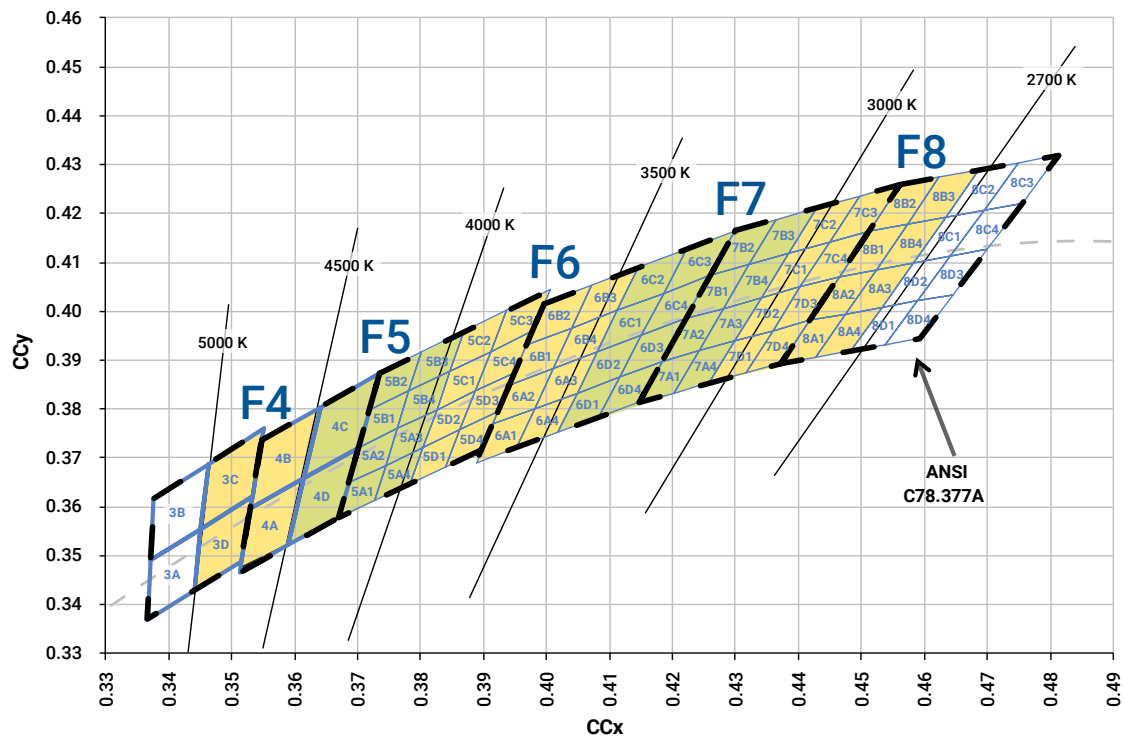
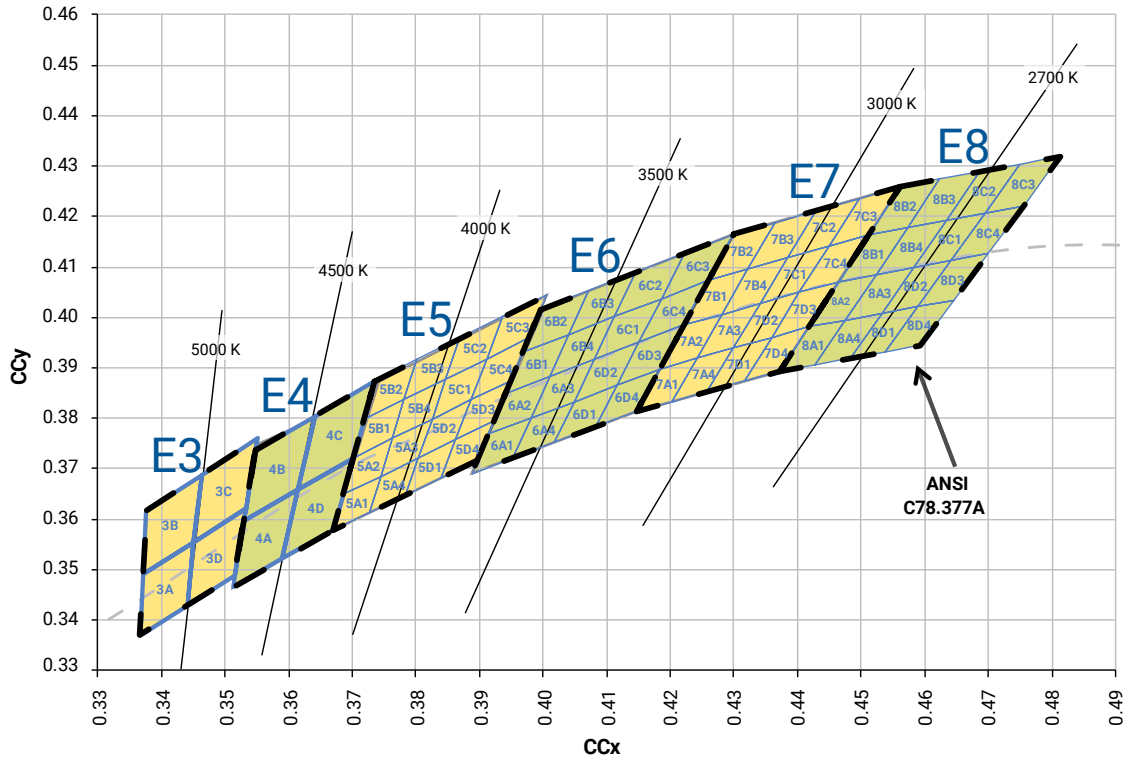

CREE'S STANDARD WARM AND NEUTRAL WHITE KITS PLOTTED ON ANSI STANDARD CHROMATICITY REGIONS - CONTINUED

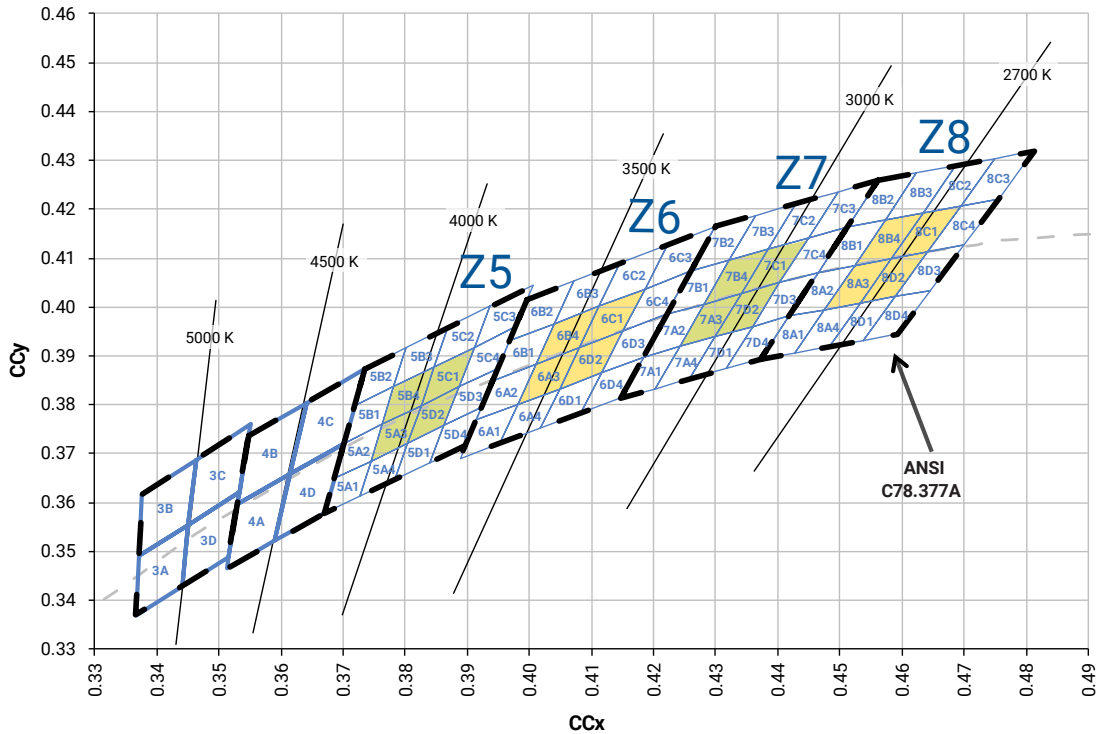

CREE'S PC AMBER KIT PLOTTED ON THE 1931 CIE CURVE

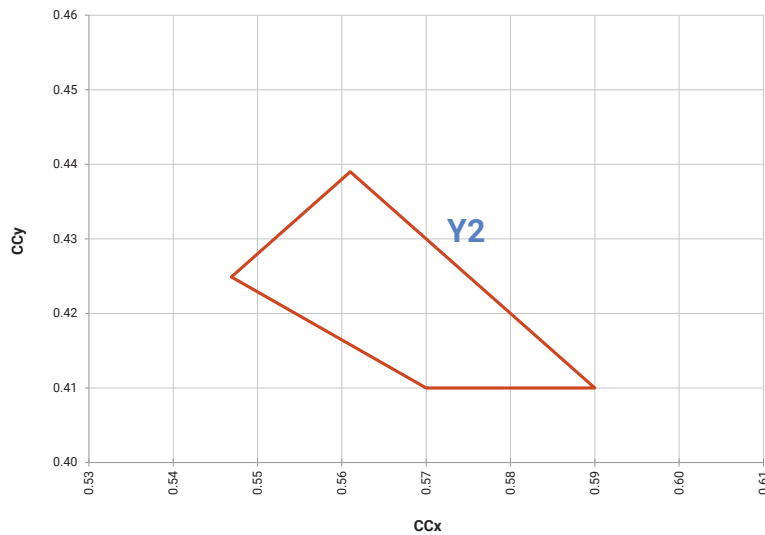

CREE'S 2200 K CCT WHITE KITS PLOTTED ON ANSI STANDARD CHROMATICITY REGIONS

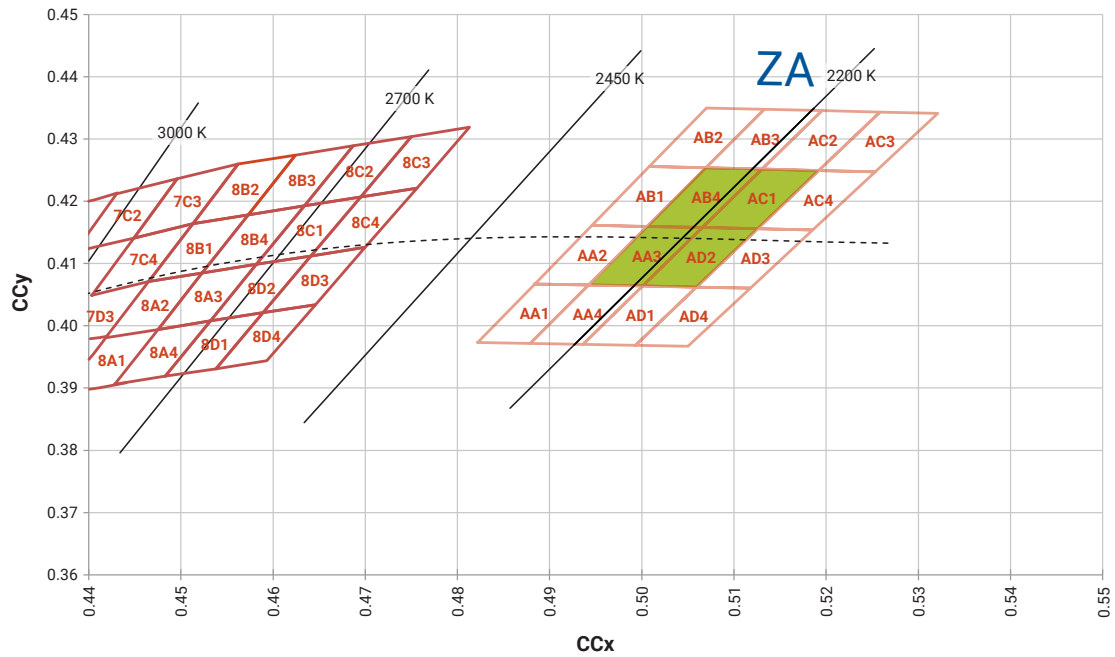
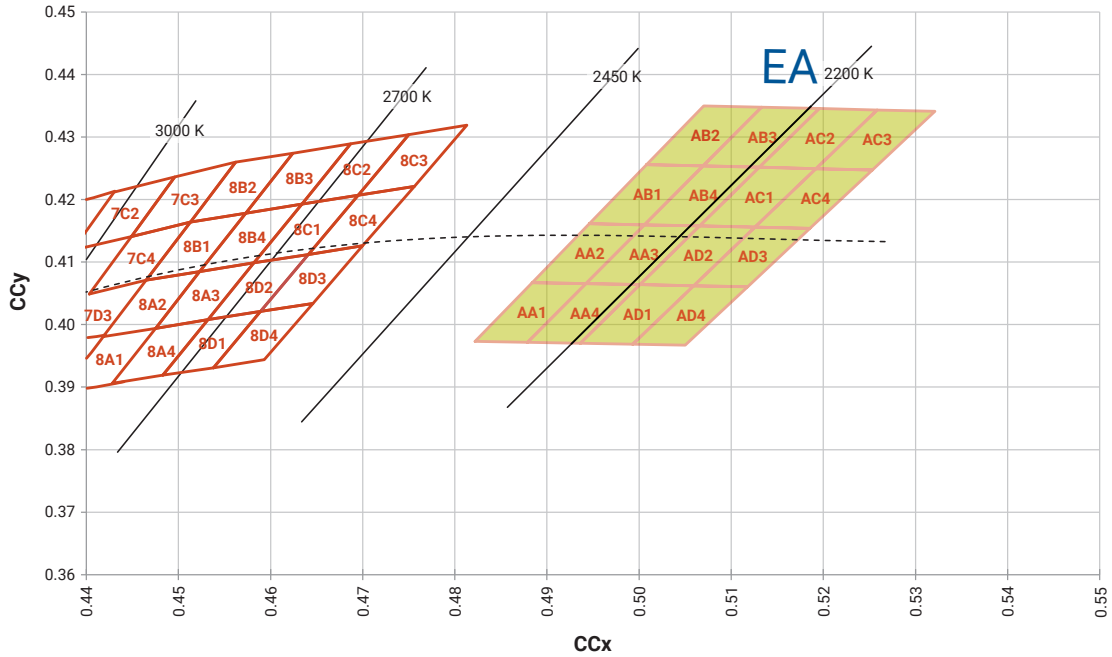

CREE'S STANDARD CHROMATICITY KITS

The following table provides the chromaticity bins associated with chromaticity kits.

Color	CCT	Kit	Chromaticity Bins
Cool White	6200 K	51	0A, 0B, 0C, 0D, 0R, 0S, 0T, 0U, 1A, 1B, 1C, 1D, 1R, 1S, 1T, 1U, 2A, 2B, 2C, 2D, 2R, 2S, 2T, 2U, 3A, 3B, 3R, 3S
	6000 K	53	1A, 1B, 1C, 1D, 1R, 1S, 1T, 1U, 2A, 2B, 2C, 2D, 2R, 2S, 2T, 3A, 3B, 3S
	6200 K	50	1A, 1B, 1C, 1D, 2A, 2B, 2C, 2D
	6500 K	E1	1A, 1B, 1C, 1D
	5700 K	E2	2A, 2B, 2C, 2D
Neutral White	5000 K	E3	3A, 3B, 3C, 3D
	4750 K	F4	3C, 3D, 4A, 4B
	4500 K	E4	4A, 4B, 4C, 4D
	4250 K	F5	4C, 4D, 5A1, 5A2, 5A3, 5A4, 5B1, 5B2, 5B3, 5B4
	4000 K	E5	5A1, 5A2, 5A3, 5A4, 5B1, 5B2, 5B3, 5B4, 5C1, 5C2, 5C3, 5C4, 5D1, 5D2, 5D3, 5D4
	4000 K	Z5	5A3, 5B4, 5C1, 5D2
Warm White	3750 K	F6	5C1, 5C2, 5C3, 5C4, 5D1, 5D2, 5D3, 5D4, 6A1, 6A2, 6A3, 6A4, 6B1, 6B2, 6B3, 6B4
	3500 K	E6	6A1, 6A2, 6A3, 6A4, 6B1, 6B2, 6B3, 6B4, 6C1, 6C2, 6C3, 6C4, 6D1, 6D2, 6D3, 6D4
	3500 K	Z6	6A3, 6B4, 6C1, 6D2
	3250 K	F7	6C1, 6C2, 6C3, 6C4, 6D1, 6D2, 6D3, 6D4, 7A1, 7A2, 7A3, 7A4, 7B1, 7B2, 7B3, 7B4
	3000 K	E7	7A1, 7A2, 7A3, 7A4, 7B1, 7B2, 7B3, 7B4, 7C1, 7C2, 7C3, 7C4, 7D1, 7D2, 7D3, 7D4
	3000 K	Z7	7A3, 7B4, 7C1, 7D2
	2850 K	F8	7C1, 7C2, 7C3, 7C4, 7D1, 7D2, 7D3, 7D4, 8A1, 8A2, 8A3, 8A4, 8B1, 8B2, 8B3, 8B4
	2700 K	E8	8A1, 8A2, 8A3, 8A4, 8B1, 8B2, 8B3, 8B4, 8C1, 8C2, 8C3, 8C4, 8D1, 8D2, 8D3, 8D4
	2700 K	Z8	8A3, 8B4, 8C1, 8D2
	2200 K	EA	AA1, AA2, AA3, AA4, AB1, AB2, AB3, AB4, AC1, AC2, AC3, AC4, AD1, AD2, AD3, AD4
	2200 K	ZA	AA3, AB4, AC1, AD2

BIN AND ORDER CODE FORMATS

XP-E2 bin codes and order codes are configured in the following manner:

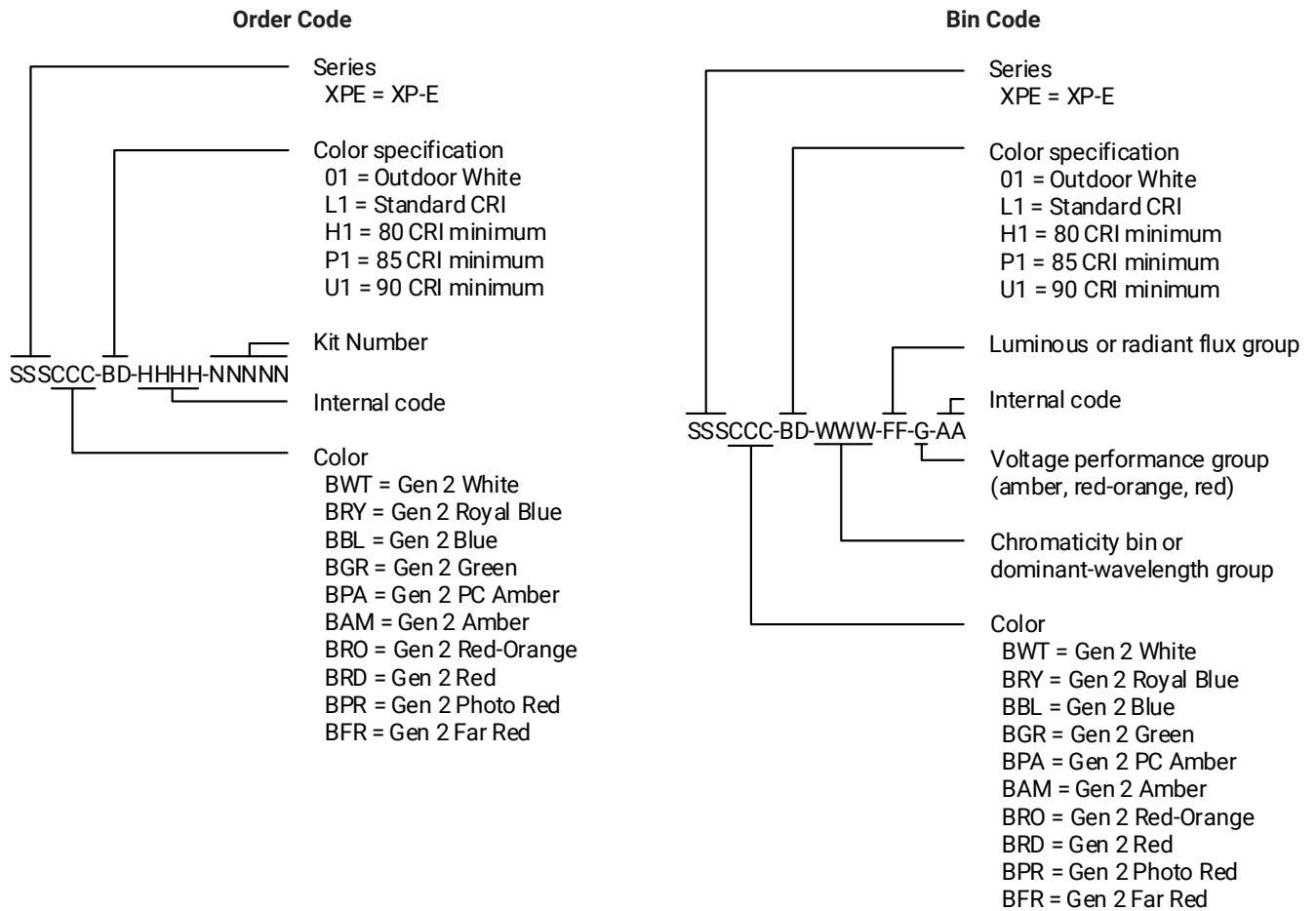

REFLOW SOLDERING CHARACTERISTICS

In testing, Cree has found XLamp XP-E2 LEDs to be compatible with JEDEC J-STD-020C, using the parameters listed below. As a general guideline, Cree recommends that users follow the recommended soldering profile provided by the manufacturer of the solder paste used, and therefore it is the lamp or luminaire manufacturer’s responsibility to determine applicable soldering requirements.

Note that this general guideline may not apply to all PCB designs and configurations of reflow soldering equipment.

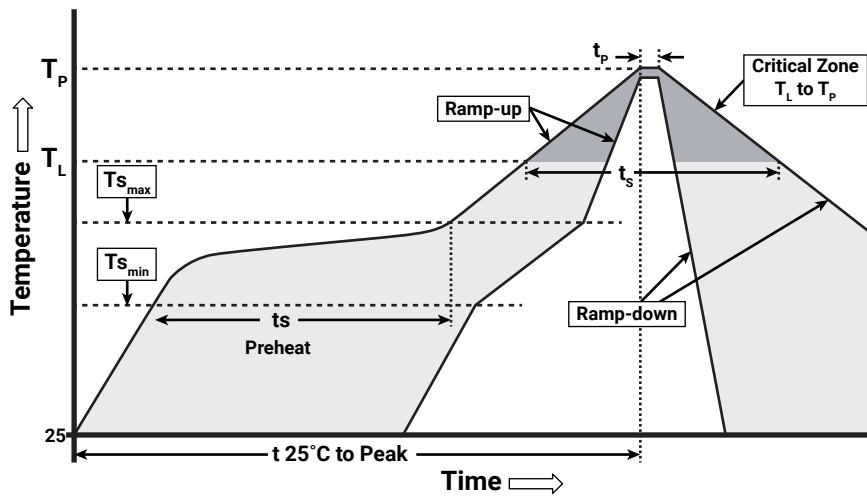

IPC/JEDEC J-STD-020C

Profile Feature	Lead-Free Solder
Average Ramp-Up Rate ($T_{s_{max}}$ to T_P)	1.2 °C/second
Preheat: Temperature Min ($T_{s_{min}}$)	120 °C
Preheat: Temperature Max ($T_{s_{max}}$)	170 °C
Preheat: Time ($t_{s_{min}}$ to $t_{s_{max}}$)	65-150 seconds
Time Maintained Above: Temperature (T_L)	217 °C
Time Maintained Above: Time (t_s)	45-90 seconds
Peak/Classification Temperature (T_P)	235 - 245 °C
Time Within 5 °C of Actual Peak Temperature (t_p)	20-40 seconds
Ramp-Down Rate	1 - 6 °C/second
Time 25 °C to Peak Temperature	4 minutes max.

Note: All temperatures refer to topside of the package, measured on the package body surface.

NOTES

Measurements

The luminous flux, radiant power, chromaticity, forward voltage and CRI measurements in this document are binning specifications only and solely represent product measurements as of the date of shipment. These measurements will change over time based on a number of factors that are not within Cree's control and are not intended or provided as operational specifications for the products. Calculated values are provided for informational purposes only and are not intended or provided as specifications.

Pre-Release Qualification Testing

Please read the [LED Reliability Overview](#) for details of the qualification process Cree applies to ensure long-term reliability for XLamp LEDs and details of Cree's pre-release qualification testing for XLamp LEDs.

Lumen Maintenance

Cree now uses standardized IES LM-80-08 and TM-21-11 methods for collecting long-term data and extrapolating LED lumen maintenance. For information on the specific LM-80 data sets available for this LED, refer to the public [LM-80 results document](#).

Please read the [Long-Term Lumen Maintenance application note](#) for more details on Cree's lumen maintenance testing and forecasting. Please read the [Thermal Management application note](#) for details on how thermal design, ambient temperature, and drive current affect the LED junction temperature.

Moisture Sensitivity

Cree recommends keeping XLamp LEDs in the provided, resealable moisture-barrier packaging (MBP) until immediately prior to soldering. Unopened MBPs that contain XLamp LEDs do not need special storage for moisture sensitivity.

Once the MBP is opened, XLamp XP-E2 LEDs may be stored as MSL 1 per JEDEC J-STD-033, meaning they have unlimited floor life in conditions of ≤ 30 °C/85% relative humidity (RH). Regardless of the storage condition, Cree recommends sealing any unsoldered LEDs in the original MBP.

RoHS Compliance

The levels of RoHS restricted materials in this product are below the maximum concentration values (also referred to as the threshold limits) permitted for such substances, or are used in an exempted application, in accordance with EU Directive 2011/65/EC (RoHS2), as implemented January 2, 2013. RoHS Declarations for this product can be obtained from your Cree representative or from the [Product Ecology](#) section of the Cree website.

REACH Compliance

REACH substances of very high concern (SVHCs) information is available for this product. Since the European Chemical Agency (ECHA) has published notice of their intent to frequently revise the SVHC listing for the foreseeable future, please contact a Cree representative to insure you get the most up-to-date REACH SVHC Declaration. REACH banned substance information (REACH Article 67) is also available upon request.

NOTES - CONTINUED

UL® Recognized Component

This product meets the requirements to be considered a UL Recognized Component with Level 4 enclosure consideration. The LED package or a portion thereof has been investigated as a fire and electrical enclosure per ANSI/UL 8750.

Vision Advisory

WARNING: Do not look at an exposed lamp in operation. Eye injury can result. For more information about LEDs and eye safety, please refer to the [LED Eye Safety application note](#).

MECHANICAL DIMENSIONS

Thermal vias, if present, are not shown on these drawings.

All measurements are ± 0.13 mm unless otherwise indicated.

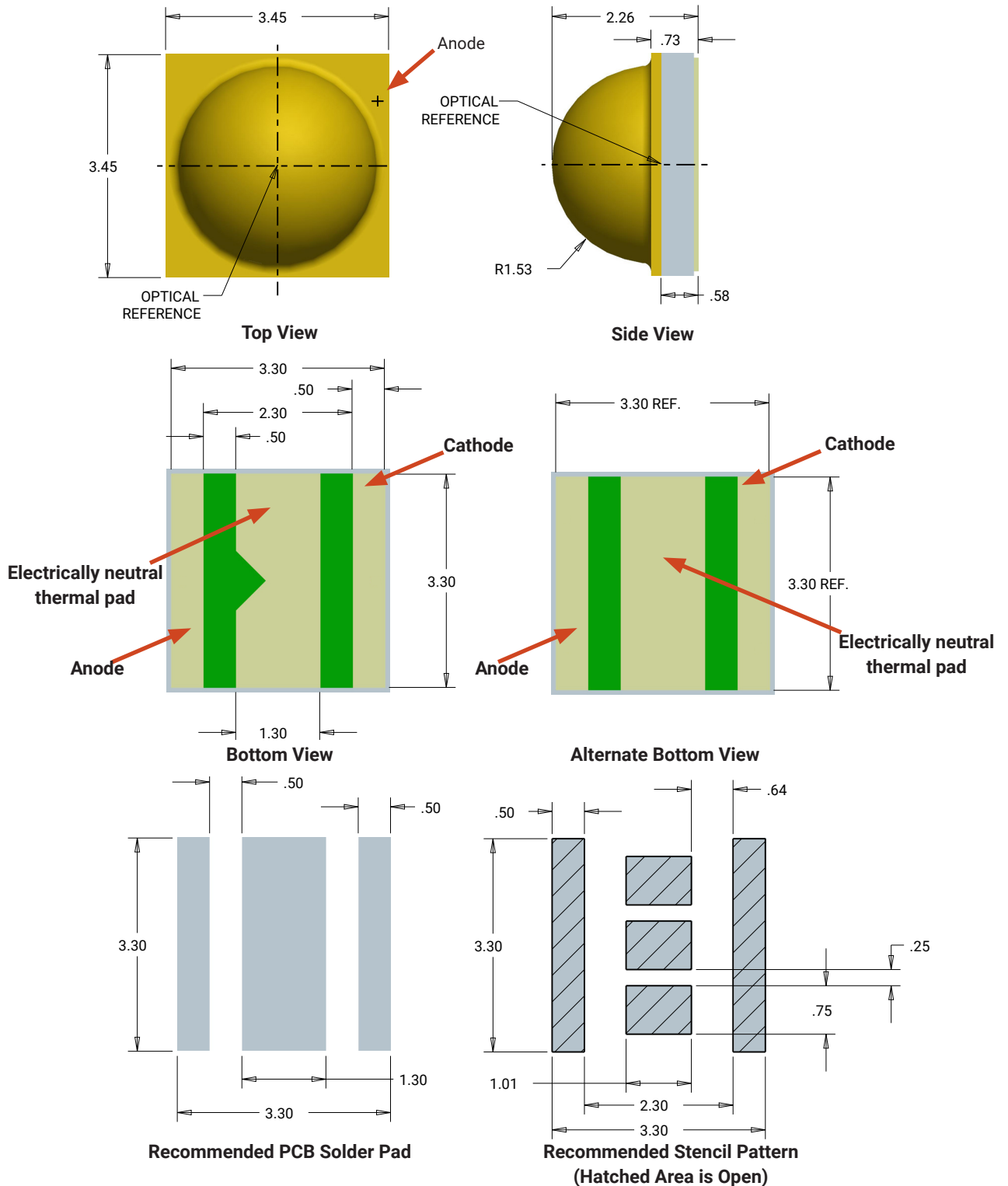

TAPE AND REEL

All Cree carrier tapes conform to EIA-481D, Automated Component Handling Systems Standard.

All dimensions in mm.

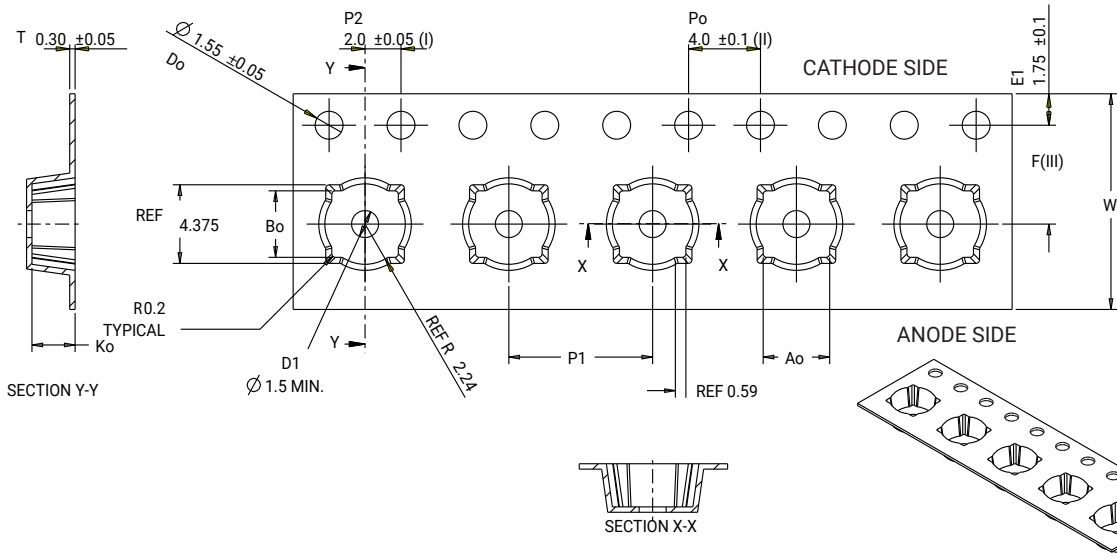

Ao	3.70	+/- 0.1
Bo	3.70	+/- 0.1
Ko	2.40	+0.0/-0.1
F	5.50	+/- 0.05
P 1	8.00	+/- 0.1
W	12.00	+0.3/-0.1

- (I) Measured from centerline of sprocket hole to centerline of pocket.
- (II) Cumulative tolerance of 10 sprocket holes is ± 0.20.
- (III) Measured from centerline of sprocket hole to centerline of pocket.
- (IV) Other material available.

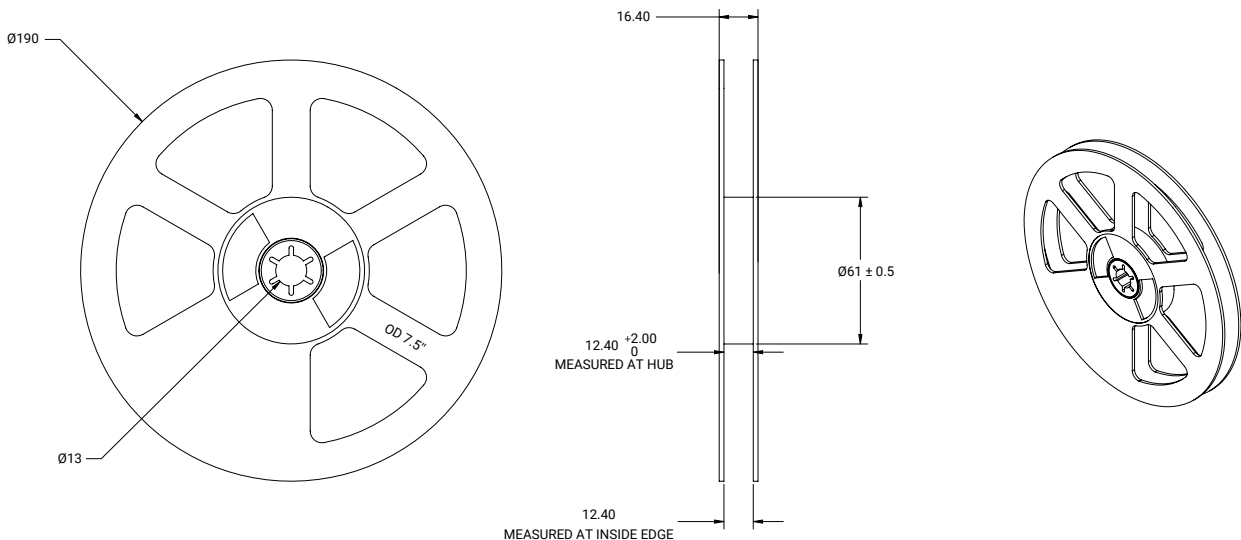
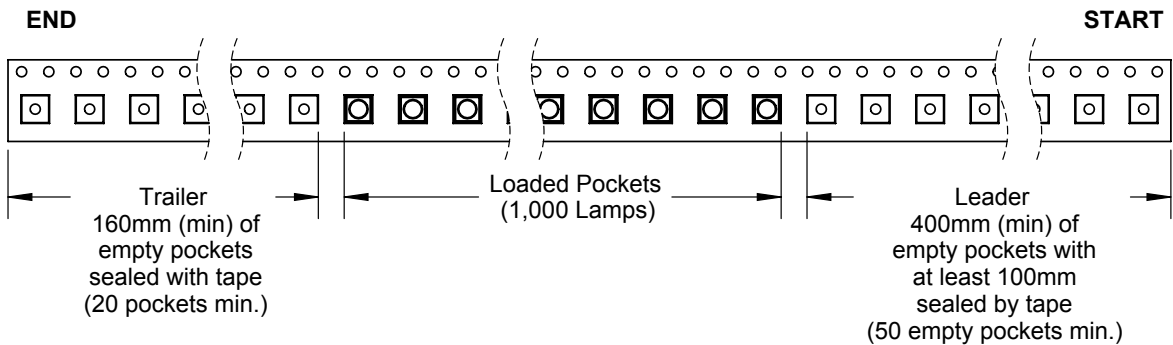

PACKAGING

Unpackaged Reel

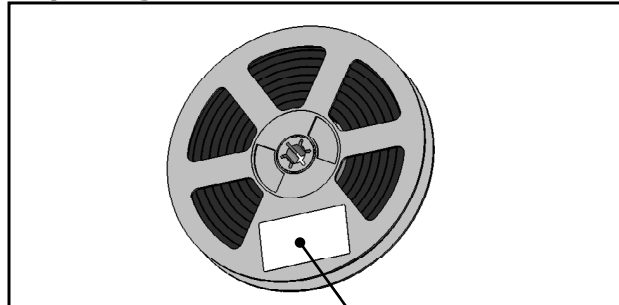

Label with Cree Bin Code,
Quantity, Reel ID

Packaged Reel

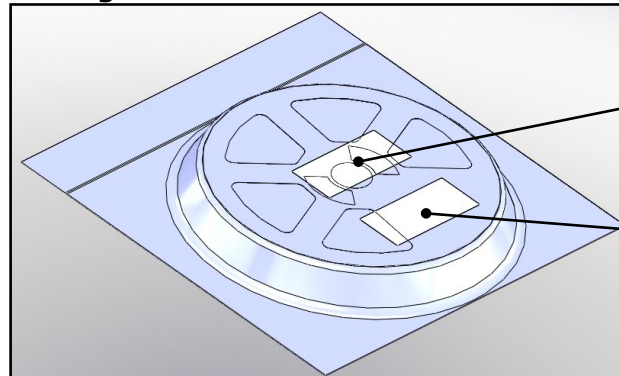

Label with Cree Order Code,
Quantity, Reel ID, PO #

Label with Cree Bin Code,
Quantity, Reel ID

Boxed Reel

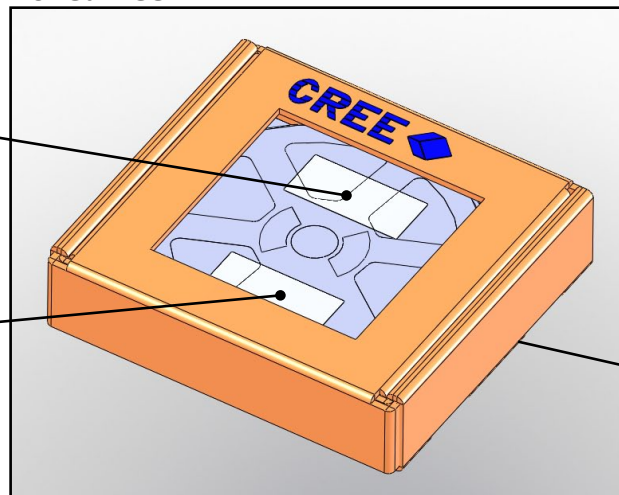

Label with Cree Order Code,
Quantity, Reel ID, PO #

Label with Cree Bin Code,
Quantity, Reel ID

Patent Label
(on bottom of box)



Компания «ЭлектроПласт» предлагает заключение долгосрочных отношений при поставках импортных электронных компонентов на взаимовыгодных условиях!

Наши преимущества:

- Оперативные поставки широкого спектра электронных компонентов отечественного и импортного производства напрямую от производителей и с крупнейших мировых складов;
- Поставка более 17-ти миллионов наименований электронных компонентов;
- Поставка сложных, дефицитных, либо снятых с производства позиций;
- Оперативные сроки поставки под заказ (от 5 рабочих дней);
- Экспресс доставка в любую точку России;
- Техническая поддержка проекта, помощь в подборе аналогов, поставка прототипов;
- Система менеджмента качества сертифицирована по Международному стандарту ISO 9001;
- Лицензия ФСБ на осуществление работ с использованием сведений, составляющих государственную тайну;
- Поставка специализированных компонентов (Xilinx, Altera, Analog Devices, Intersil, Interpoint, Microsemi, Aeroflex, Peregrine, Syfer, Eurofarad, Texas Instrument, Miteq, Cobham, E2V, MA-COM, Hittite, Mini-Circuits, General Dynamics и др.);

Помимо этого, одним из направлений компании «ЭлектроПласт» является направление «Источники питания». Мы предлагаем Вам помощь Конструкторского отдела:

- Подбор оптимального решения, техническое обоснование при выборе компонента;
- Подбор аналогов;
- Консультации по применению компонента;
- Поставка образцов и прототипов;
- Техническая поддержка проекта;
- Защита от снятия компонента с производства.



Как с нами связаться

Телефон: 8 (812) 309 58 32 (многоканальный)

Факс: 8 (812) 320-02-42

Электронная почта: org@eplast1.ru

Адрес: 198099, г. Санкт-Петербург, ул. Калинина, дом 2, корпус 4, литера А.