

**ADG819/ADG820****FEATURES**

Low On Resistance 0.8  $\Omega$  Max at 125°C  
0.25  $\Omega$  Max On Resistance Flatness  
1.8 V to 5.5 V Single Supply  
200 mA Current Carrying Capability  
Automotive Temperature Range: -40°C to +125°C  
Rail-to-Rail Operation  
6-Lead SOT-23 Package, 8-Lead  $\mu$ SOIC Package, and  
6-Bump MicroCSP (Micro Chip Scale Package) ADG819  
Fast Switching Times  
Typical Power Consumption (<0.01  $\mu$ W)  
TTL-/CMOS-Compatible Inputs  
Pin Compatible with the ADG719 (ADG819)

**APPLICATIONS**

Power Routing  
Battery-Powered Systems  
Communication Systems  
Data Acquisition Systems  
Cellular Phones  
Modems  
PCMCIA Cards  
Hard Drives  
Relay Replacement

**GENERAL DESCRIPTION**

The ADG819 and the ADG820 are monolithic, CMOS, SPDT (single-pole, double-throw) switches. These switches are designed on a submicron process that provides low power dissipation yet gives high switching speed, low On resistance, and low leakage currents.

Low power consumption and an operating supply range of 1.8 V to 5.5 V make the ADG819 and ADG820 ideal for battery-powered, portable instruments.

Each switch of the ADG819 and the ADG820 conducts equally well in both directions when on. The ADG819 exhibits break-before-make switching action, thus preventing momentary shorting when switching channels. The ADG820 exhibits make-before-break action.

The ADG819 and the ADG820 are available in a 6-lead SOT-23 package and an 8-lead  $\mu$ SOIC package. The ADG819 is also available in a 2  $\times$  3 bump 1.14 mm  $\times$  2.18 mm MicroCSP package. This chip occupies only a 1.14 mm  $\times$  2.18 mm area, making it the ideal candidate for space-constrained applications.

REV. 0

Information furnished by Analog Devices is believed to be accurate and reliable. However, no responsibility is assumed by Analog Devices for its use, nor for any infringements of patents or other rights of third parties that may result from its use. No license is granted by implication or otherwise under any patent or patent rights of Analog Devices.

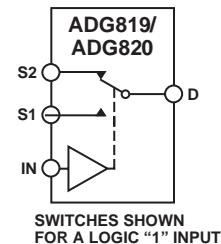
**FUNCTIONAL BLOCK DIAGRAM****PRODUCT HIGHLIGHTS**

1. Very low ON resistance, 0.5  $\Omega$  typical
2. 1.8 V to 5.5 V single-supply operation
3. High current carrying capability
4. Tiny 6-lead SOT-23 package, 8-lead  $\mu$ SOIC package, and 2  $\times$  3 bump 1.14 mm  $\times$  2.18 mm MicroCSP package (ADG819 only)

# ADG819/ADG820—SPECIFICATIONS<sup>1</sup> ( $V_{DD} = 5\text{ V} \pm 10\%$ , $GND = 0\text{ V}$ )

Parameter	25°C	-40°C to +85°C	-40°C to +125°C <sup>2</sup>	Unit	Test Conditions/Comments
<b>ANALOG SWITCH</b>					
Analog Signal Range			0 V to $V_{DD}$	V	
ON Resistance ( $R_{ON}$ )	0.5			$\Omega$ typ	$V_S = 0\text{ V}$ to $V_{DD}$ , $I_S = 100\text{ mA}$ ; Test Circuit 1
	0.6	0.7	0.8	$\Omega$ max	
ON Resistance Match Between Channels ( $\Delta R_{ON}$ )	0.06			$\Omega$ typ	$V_S = 0\text{ V}$ to $V_{DD}$ , $I_S = 100\text{ mA}$
	0.08	0.1	0.12	$\Omega$ max	
ON Resistance Flatness ( $R_{FLAT(ON)}$ )	0.1			$\Omega$ typ	$V_S = 0\text{ V}$ to $V_{DD}$ , $I_S = 100\text{ mA}$
	0.17	0.2	0.25	$\Omega$ max	
<b>LEAKAGE CURRENTS</b>					
Source OFF Leakage $I_S$ (OFF)	$\pm 0.01$			nA typ	$V_{DD} = 5.5\text{ V}$ $V_S = 4.5\text{ V}/1\text{ V}$ , $V_D = 1\text{ V}/4.5\text{ V}$ ; Test Circuit 2
	$\pm 0.25$	$\pm 3$	$\pm 10$	nA max	
Channel ON Leakage $I_D$ , $I_S$ (ON)	$\pm 0.01$			nA typ	$V_S = V_D = 1\text{ V}$ , or $V_S = V_D = 4.5\text{ V}$ ; Test Circuit 3
	$\pm 0.25$	$\pm 3$	$\pm 25$	nA max	
<b>DIGITAL INPUTS</b>					
Input High Voltage, $V_{INH}$			2.0	V min	
Input Low Voltage, $V_{INL}$			0.8	V max	
Input Current $I_{INL}$ or $I_{INH}$	0.005		$\pm 0.1$	$\mu\text{A}$ typ $\mu\text{A}$ max	$V_{IN} = V_{INL}$ or $V_{INH}$
$C_{IN}$ , Digital Input Capacitance	5			pF typ	
<b>DYNAMIC CHARACTERISTICS<sup>3</sup></b>					
<b>ADG819</b>					
$t_{ON}$	35			ns typ	$R_L = 50\ \Omega$ , $C_L = 35\text{ pF}$ , $V_S = 3\text{ V}$ ; Test Circuit 4
	45	50	55	ns max	
$t_{OFF}$	10			ns typ	$R_L = 50\ \Omega$ , $C_L = 35\text{ pF}$ , $V_S = 3\text{ V}$ ; Test Circuit 4
	16	18	21	ns max	
Break-Before-Make Time Delay, $t_{BBM}$	5		1	ns typ ns min	$R_L = 50\ \Omega$ , $C_L = 35\text{ pF}$ , $V_{S1} = V_{S2} = 3\text{ V}$ ; Test Circuit 5
<b>ADG820</b>					
$t_{ON}$	10			ns typ	$R_L = 50\ \Omega$ , $C_L = 35\text{ pF}$ , $V_S = 3\text{ V}$ ; Test Circuit 4
	18	20	22	ns max	
$t_{OFF}$	26			ns typ	$R_L = 50\ \Omega$ , $C_L = 35\text{ pF}$ , $V_S = 3\text{ V}$ ; Test Circuit 4
	40	45	50	ns max	
Make-Before-Break Time Delay, $t_{MBB}$	15		1	ns typ ns min	$R_L = 50\ \Omega$ , $C_L = 35\text{ pF}$ , $V_S = 0\text{ V}$ ; Test Circuit 6
Charge Injection	20			pC typ	$V_S = 2.5\text{ V}$ , $R_S = 0\ \Omega$ , $C_L = 1\text{ nF}$ ; Test Circuit 7
Off Isolation	-71			dB typ	$R_L = 50\ \Omega$ , $C_L = 5\text{ pF}$ , $f = 100\text{ kHz}$ ; Test Circuit 8
Channel-to-Channel Crosstalk	-72			dB typ	$R_L = 50\ \Omega$ , $C_L = 5\text{ pF}$ , $f = 100\text{ kHz}$ ; Test Circuit 10
Bandwidth -3 dB	17			MHz typ	$R_L = 50\ \Omega$ , $C_L = 5\text{ pF}$ ; Test Circuit 9
$C_S$ (OFF)	80			pF typ	$f = 1\text{ MHz}$
$C_D$ , $C_S$ (ON)	300			pF typ	$f = 1\text{ MHz}$
<b>POWER REQUIREMENTS</b>					
$I_{DD}$	0.001			$\mu\text{A}$ typ	$V_{DD} = 5.5\text{ V}$ Digital Inputs = 0 V or 5.5 V
		1.0	2.0	$\mu\text{A}$ max	

## NOTES

<sup>1</sup>Temperature range is as follows: -40°C to +125°C.

<sup>2</sup>ON resistance parameters tested with  $I_S = 10\text{ mA}$ .

<sup>3</sup>Guaranteed by design, not subject to production test.

Specifications subject to change without notice.

# SPECIFICATIONS<sup>1</sup> ( $V_{DD} = 2.7\text{ V to }3.6\text{ V, GND} = 0\text{ V.}$ )

Parameter	25°C	-40°C to +85°C	-40°C to +125°C <sup>2</sup>	Unit	Test Conditions/Comments
<b>ANALOG SWITCH</b>					
Analog Signal Range			0 V to $V_{DD}$	V	
ON Resistance ( $R_{ON}$ )	0.7			$\Omega$ typ $\Omega$ max	$V_S = 0\text{ V to }V_{DD}$ , $I_S = 100\text{ mA}$ ; Test Circuit 1
ON Resistance Match Between Channels ( $\Delta R_{ON}$ )	0.06	1.5	1.6	$\Omega$ typ $\Omega$ max	$V_S = 0\text{ V to }V_{DD}$ , $I_S = 100\text{ mA}$
ON Resistance Flatness ( $R_{FLAT(ON)}$ )	0.25	0.13	0.13	$\Omega$ typ	$V_S = 0\text{ V to }V_{DD}$ , $I_S = 100\text{ mA}$
<b>LEAKAGE CURRENTS</b>					
Source OFF Leakage $I_S$ (OFF)	$\pm 0.01$ $\pm 0.25$	$\pm 3$	$\pm 10$	nA typ nA max	$V_{DD} = 3.6\text{ V}$ $V_S = 3.3\text{ V}/1\text{ V}$ , $V_D = 1\text{ V}/3.3\text{ V}$ ; Test Circuit 2
Channel ON Leakage $I_D$ , $I_S$ (ON)	$\pm 0.01$ $\pm 0.25$	$\pm 3$	$\pm 25$	nA typ nA max	$V_S = V_D = 1\text{ V}$ , or $V_S = V_D = 3.3\text{ V}$ ; Test Circuit 3
<b>DIGITAL INPUTS</b>					
Input High Voltage, $V_{INH}$			2.0	V min	
Input Low Voltage, $V_{INL}$			0.8	V max	
Input Current $I_{INL}$ or $I_{INH}$	0.005		$\pm 0.1$	$\mu\text{A}$ typ $\mu\text{A}$ max	$V_{IN} = V_{INL}$ or $V_{INH}$
$C_{IN}$ , Digital Input Capacitance	5			pF typ	
<b>DYNAMIC CHARACTERISTICS<sup>3</sup></b>					
<b>ADG819</b>					
$t_{ON}$	40			ns typ	$R_L = 50\ \Omega$ , $C_L = 35\text{ pF}$ , $V_S = 1.5\text{ V}$ ; Test Circuit 4
	60	65	70	ns max	
$t_{OFF}$	10			ns typ	$R_L = 50\ \Omega$ , $C_L = 35\text{ pF}$ , $V_S = 1.5\text{ V}$ ; Test Circuit
	16	18	21	ns max	
Break-Before-Make Time Delay, $t_{BBM}$	40			ns typ	$R_L = 50\ \Omega$ , $C_L = 35\text{ pF}$ , $V_{S1} = V_{S2} = 1.5\text{ V}$ ; Test Circuit 5
			1	ns min	
<b>ADG820</b>					
$t_{ON}$	20			ns typ	$R_L = 50\ \Omega$ , $C_L = 35\text{ pF}$ , $V_S = 1.5\text{ V}$ ; Test Circuit 4
	35	40	45	ns max	
$t_{OFF}$	30			ns typ	$R_L = 50\ \Omega$ , $C_L = 35\text{ pF}$ , $V_S = 1.5\text{ V}$ ; Test Circuit 4
	45	50	55	ns max	
Make-Before-Break Time Delay, $t_{MKB}$	10			ns typ	$R_L = 50\ \Omega$ , $C_L = 35\text{ pF}$ , $V_S = 1.5\text{ V}$ ; Test Circuit 6
			1	ns min	
Charge Injection	10			pC typ	$V_S = 1.5\text{ V}$ , $R_S = 0\ \Omega$ , $C_L = 1\text{ nF}$ ; Test Circuit 7
Off Isolation	-71			dB typ	$R_L = 50\ \Omega$ , $C_L = 5\text{ pF}$ , $f = 100\text{ kHz}$ ; Test Circuit 8
Channel-to-Channel Crosstalk	-72			dB typ	$R_L = 50\ \Omega$ , $C_L = 5\text{ pF}$ , $f = 100\text{ kHz}$ ; Test Circuit 10
Bandwidth -3 dB	17			MHz typ	$R_L = 50\ \Omega$ , $C_L = 5\text{ pF}$ ; Test Circuit 9
$C_S$ (OFF)	80			pF typ	$f = 1\text{ MHz}$
$C_D$ , $C_S$ (ON)	300			pF typ	$f = 1\text{ MHz}$
<b>POWER REQUIREMENTS</b>					
$I_{DD}$	0.001			$\mu\text{A}$ typ $\mu\text{A}$ max	$V_{DD} = 3.6\text{ V}$ Digital Inputs = 0 V or 3.6 V
		1.0	2.0		

## NOTES

<sup>1</sup>Temperature range is as follows: -40°C to +125°C.<sup>2</sup>ON resistance parameters tested with  $I_S = 10\text{ mA}$ .<sup>3</sup>Guaranteed by design, not subject to production test.

Specifications subject to change without notice.

# ADG819/ADG820

## ABSOLUTE MAXIMUM RATINGS<sup>1</sup>

(T<sub>A</sub> = 25°C, unless otherwise noted.)

V <sub>DD</sub> to GND	-0.3 V to +7 V
Analog Inputs <sup>2</sup>	-0.3 V to V <sub>DD</sub> + 0.3 V or 30 mA, Whichever Occurs First
Digital Inputs <sup>2</sup>	-0.3 V to V <sub>DD</sub> + 0.3 V or 30 mA, Whichever Occurs First
Peak Current, S or D	400 mA (Pulsed at 1 ms, 10% Duty Cycle Max)
Continuous Current, S or D	200 mA
Operating Temperature Range	
Industrial	-40°C to +85°C
Automotive	-40°C to +125°C
Storage Temperature Range	-65°C to +150°C
Junction Temperature	150°C
μSOIC Package	
θ <sub>JA</sub> Thermal Impedance	206°C/W
θ <sub>JC</sub> Thermal Impedance	44°C/W
SOT-23 Package (4-Layer Board)	
θ <sub>JA</sub> Thermal Impedance	119°C/W

## MicroCSP Package

θ <sub>JA</sub> Thermal Impedance	TBD
Lead Temperature, Soldering (10 sec)	300°C
IR Reflow, Peak Temperature (<20 sec)	235°C

## NOTES

<sup>1</sup>Stresses above those listed under Absolute Maximum Ratings may cause permanent damage to the device. This is a stress rating only; functional operation of the device at these or any other conditions above those listed in the operational sections of this specification is not implied. Exposure to absolute maximum rating conditions for extended periods may affect device reliability. Only one absolute maximum rating may be applied at any one time.

<sup>2</sup>Overvoltages at IN, S, or D will be clamped by internal diodes. Current should be limited to the maximum ratings given.

**Table I. Truth Table for the ADG819/ADG820**

IN	Switch S1	Switch S2
0	ON	OFF
1	OFF	ON

## PIN CONFIGURATIONS

### 6-Lead SOT-23 (RJ-6)

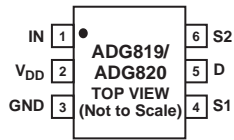

### 8-Lead μSOIC (RM-8)

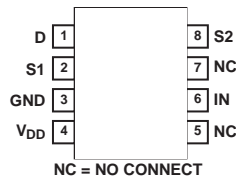

### 2 × 3 MicroCSP

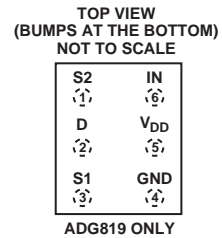

## ORDERING GUIDE

Model Option	Temperature Range	Brand <sup>1</sup>	Package Description	Package
ADG819BRM	-40°C to +125°C	SNB	μSOIC (MicroSmall Outline IC)	RM-8
ADG819BRT	-40°C to +125°C	SNB	SOT-23 (Plastic Surface-Mount)	RJ-6 <sup>2</sup>
ADG819BCB	-40°C to +85°C	SNB	MicroCSP (Micro Chip Scale Package)	CB-6 <sup>2</sup>
ADG820BRM	-40°C to +125°C	SPB	μSOIC (MicroSmall Outline IC)	RM-8
ADG820BRT	-40°C to +125°C	SPB	SOT-23 (Plastic Surface-Mount)	RJ-6 <sup>2</sup>

## NOTES

<sup>1</sup>Branding on these packages is limited to three characters due to space constraints.

<sup>2</sup>Contact factory for availability.

## TERMINOLOGY

$V_{DD}$	Most Positive Power Supply Potential
GND	Ground (0 V) Reference
$I_{DD}$	Positive Supply Current
S	Source Terminal. May be an input or output.
D	Drain Terminal. May be an input or output.
IN	Logic Control Input
$R_{ON}$	Ohmic Resistance between D and S
$\Delta R_{ON}$	ON Resistance Match between Any Two Channels, i.e., $R_{ON\ max} - R_{ON\ min}$
$R_{FLAT(ON)}$	Flatness is defined as the difference between the maximum and minimum value of ON resistance as measured over the specified analog signal range.
$I_S$ (OFF)	Source Leakage Current with the Switch OFF
$I_D, I_S$ (ON)	Channel Leakage Current with the Switch ON
$V_D$ ( $V_S$ )	Analog Voltage on Terminals D, S
$V_{INL}$	Maximum Input Voltage for Logic "0"
$V_{INH}$	Minimum Input Voltage for Logic "1"
$I_{INL}$ ( $I_{INH}$ )	Input Current of the Digital Input
$C_S$ (OFF)	OFF Switch Source Capacitance
$C_D, C_S$ (ON)	ON Switch Capacitance
$t_{ON}$	Delay between applying the digital control input and the output switching ON.
$t_{OFF}$	Delay between applying the digital control input and the output switching OFF.
$t_{BBM}$	OFF time or ON time measured between the 90% points of both switches when switching from one address state to another.
$t_{MBB}$	ON time measured between the 80% points of both switches when switching from one address state to another.
Charge Injection	A measure of the glitch impulse transferred from the digital input to the analog output during switching.
Crosstalk	A measure of unwanted signal coupled through from one channel to another as a result of parasitic capacitance.
OFF Isolation	A measure of unwanted signal coupling through an OFF switch.
Bandwidth	Frequency at which the output is attenuated by -3 dB.
ON Response	Frequency Response of the ON Switch
Insertion Loss	Loss due to the ON Resistance of the Switch

**CAUTION**

ESD (electrostatic discharge) sensitive device. Electrostatic charges as high as 4000 V readily accumulate on the human body and test equipment and can discharge without detection. Although the ADG819/ADG820 features proprietary ESD protection circuitry, permanent damage may occur on devices subjected to high energy electrostatic discharges. Therefore, proper ESD precautions are recommended to avoid performance degradation or loss of functionality.



# ADG819/ADG820 – Typical Performance Characteristics

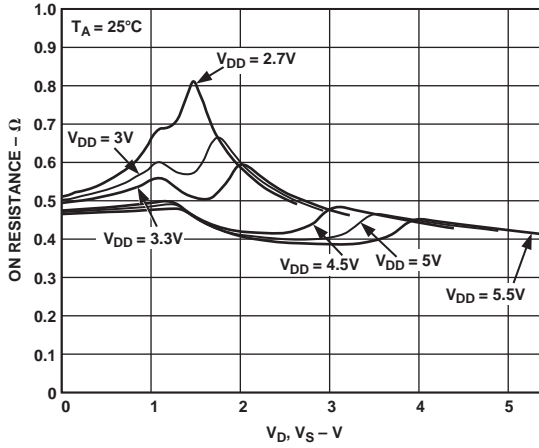

TPC 1. ON Resistance vs.  $V_D$  ( $V_S$ )

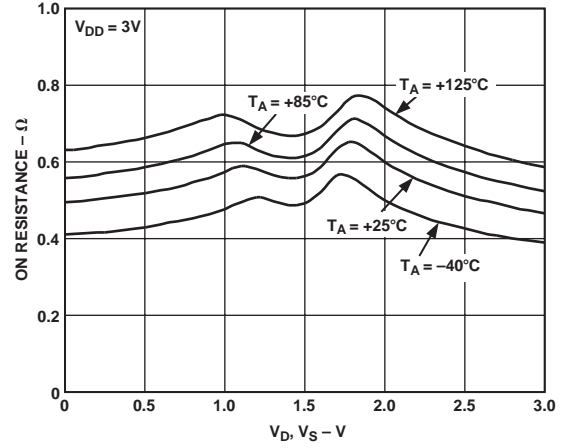

TPC 4. ON Resistance vs.  $V_D$  ( $V_S$ ) for Different Temperatures

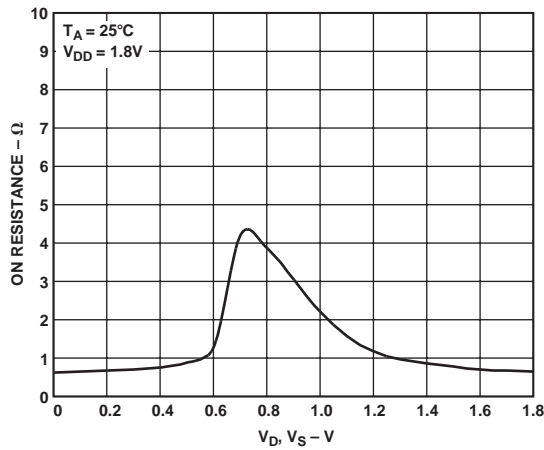

TPC 2. ON Resistance vs.  $V_D$  ( $V_S$ )

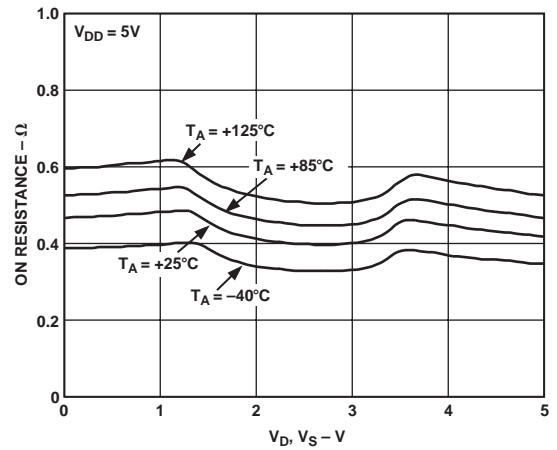

TPC 5. ON Resistance vs.  $V_D$  ( $V_S$ ) for Different Temperatures

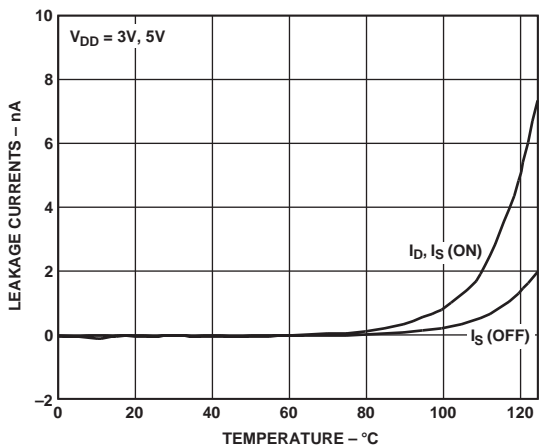

TPC 3. Leakage Currents vs. Temperatures

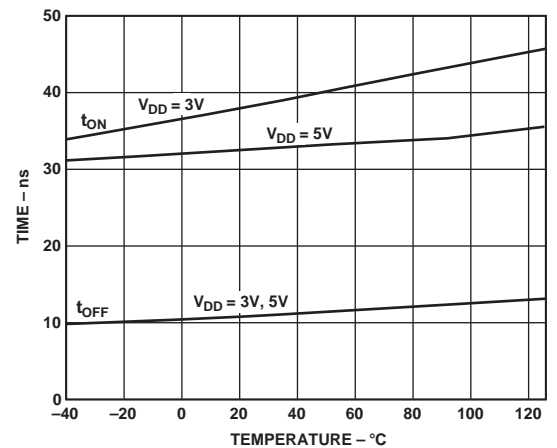

TPC 6.  $t_{ON}/t_{OFF}$  Times vs. Temperature (ADG819)

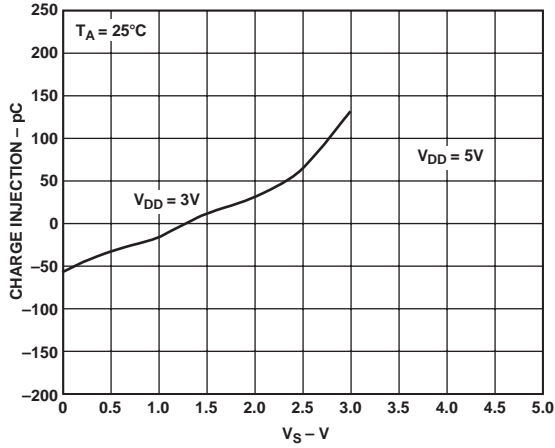

TPC 7. Charge Injection vs. Source Voltage

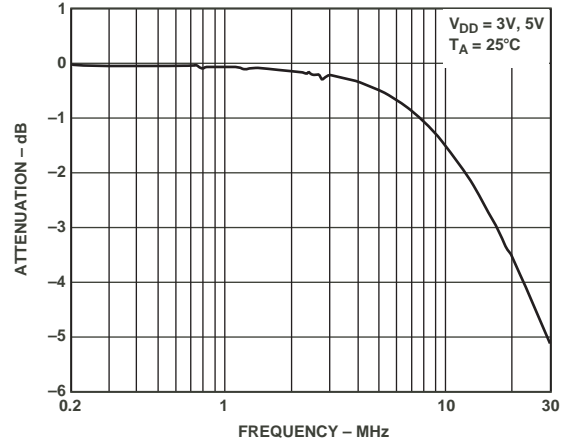

TPC 10. ON Response vs. Frequency

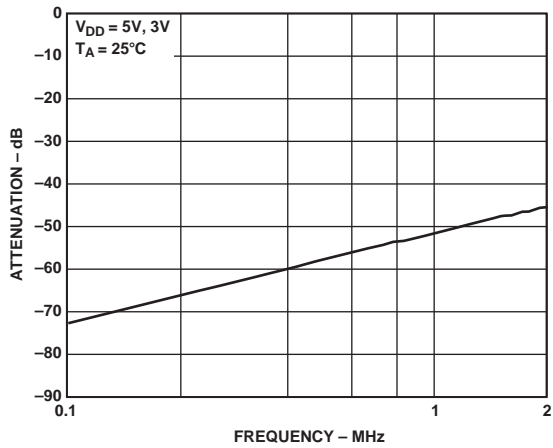

TPC 8. OFF Isolation vs. Frequency

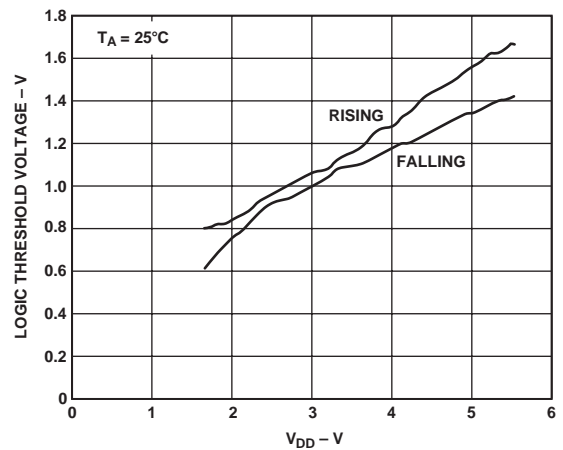

TPC 11. Logic Threshold vs. Supply Voltage

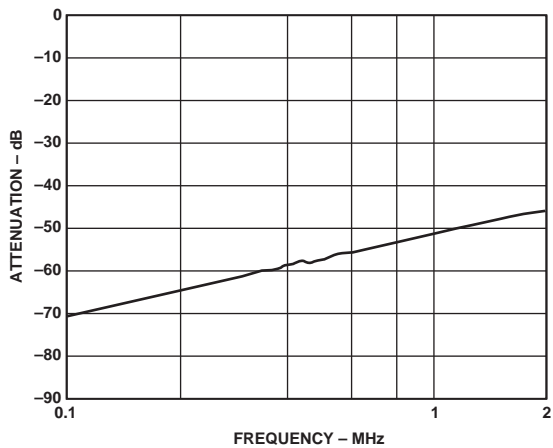

TPC 9. Crosstalk vs. Frequency

# ADG819/ADG820

## Test Circuits

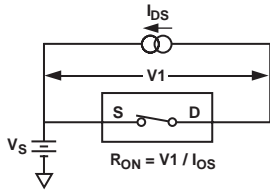

Test Circuit 1. ON Resistance

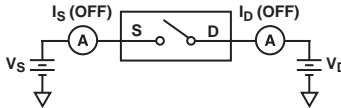

Test Circuit 2. OFF Leakage

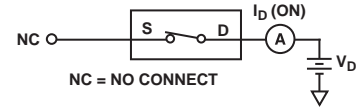

Test Circuit 3. ON Leakage

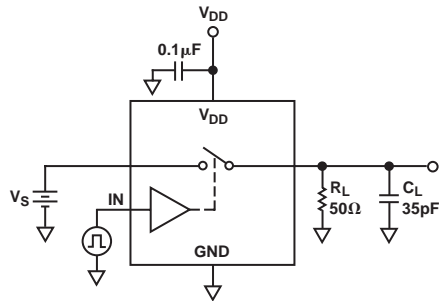

Test Circuit 4. Switching Times

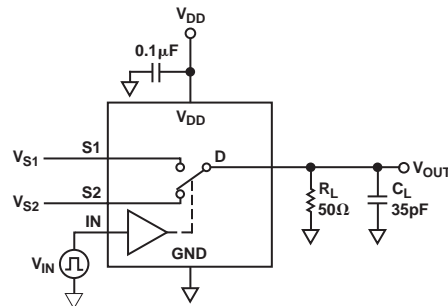

Test Circuit 5. Break-Before-Make Time Delay,  $t_{BBM}$  (ADG819 Only)

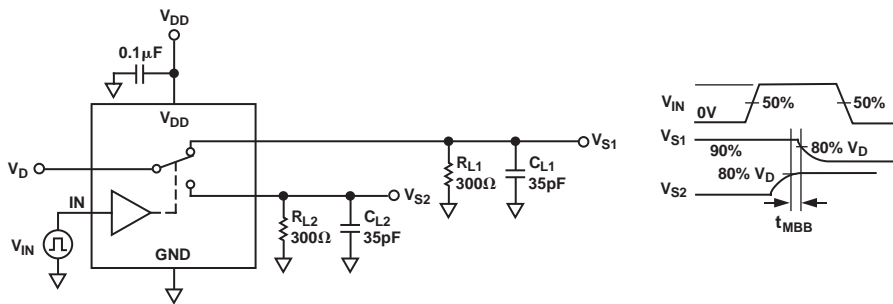

Test Circuit 6. Make-Before-Break Time Delay,  $t_{MBB}$  (ADG820 Only)





## OUTLINE DIMENSIONS

### 6-Lead Plastic Surface-Mount Package (RJ-6)

Dimensions shown in inches and (mm)

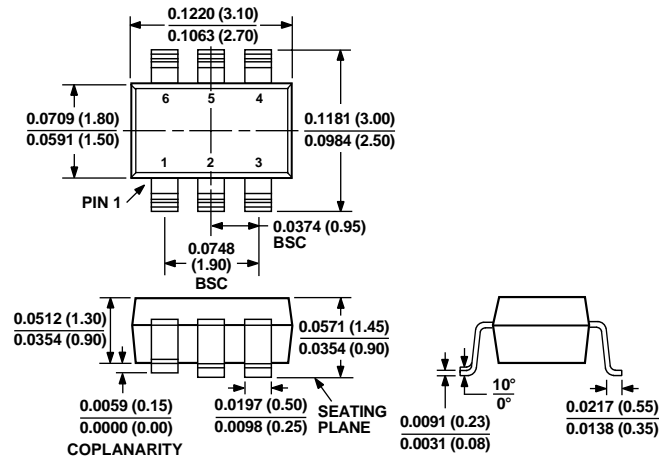

### 8-Lead $\mu$ SOIC Package (RM-8)

Dimensions shown in inches and (mm)

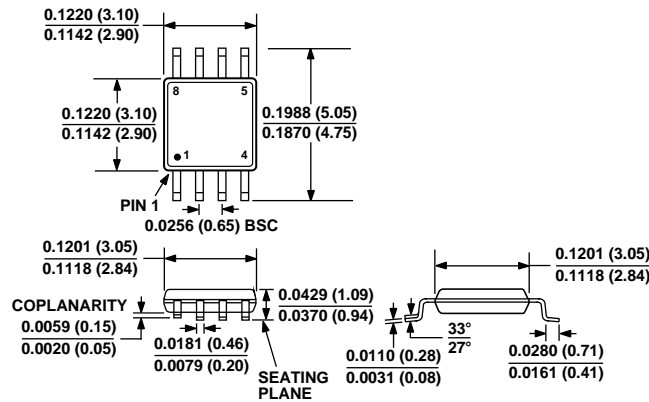

### 2 × 3 Array for MicroCSP (CB-6)

Dimensions shown in millimeters and (inches)

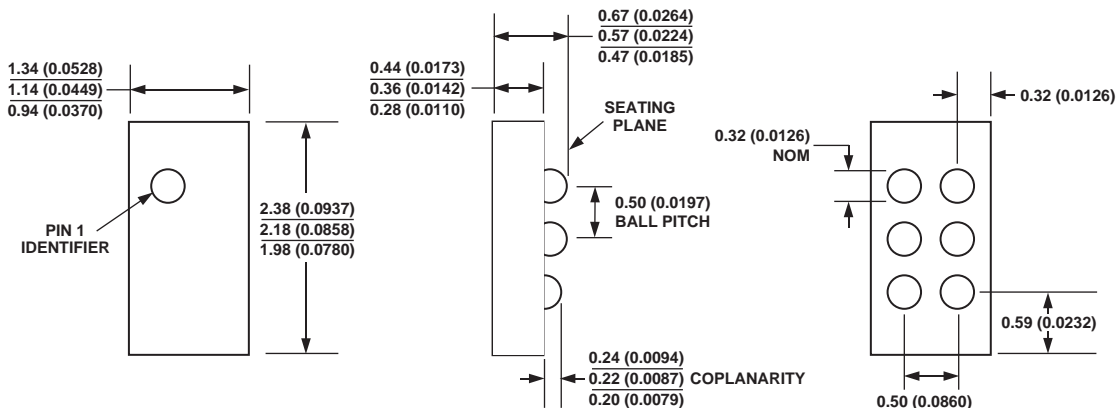

CONTROLLING DIMENSIONS ARE IN MILLIMETERS; INCH DIMENSIONS (IN PARENTHESES) ARE ROUNDED-OFF MILLIMETER EQUIVALENTS FOR REFERENCE ONLY AND ARE NOT APPROPRIATE FOR USE IN DESIGN







Компания «ЭлектроПласт» предлагает заключение долгосрочных отношений при поставках импортных электронных компонентов на взаимовыгодных условиях!

Наши преимущества:

- Оперативные поставки широкого спектра электронных компонентов отечественного и импортного производства напрямую от производителей и с крупнейших мировых складов;
- Поставка более 17-ти миллионов наименований электронных компонентов;
- Поставка сложных, дефицитных, либо снятых с производства позиций;
- Оперативные сроки поставки под заказ (от 5 рабочих дней);
- Экспресс доставка в любую точку России;
- Техническая поддержка проекта, помощь в подборе аналогов, поставка прототипов;
- Система менеджмента качества сертифицирована по Международному стандарту ISO 9001;
- Лицензия ФСБ на осуществление работ с использованием сведений, составляющих государственную тайну;
- Поставка специализированных компонентов (Xilinx, Altera, Analog Devices, Intersil, Interpoint, Microsemi, Aeroflex, Peregrine, Syfer, Eurofarad, Texas Instrument, Miteq, Cobham, E2V, MA-COM, Hittite, Mini-Circuits, General Dynamics и др.);

Помимо этого, одним из направлений компании «ЭлектроПласт» является направление «Источники питания». Мы предлагаем Вам помощь Конструкторского отдела:

- Подбор оптимального решения, техническое обоснование при выборе компонента;
- Подбор аналогов;
- Консультации по применению компонента;
- Поставка образцов и прототипов;
- Техническая поддержка проекта;
- Защита от снятия компонента с производства.



#### Как с нами связаться

**Телефон:** 8 (812) 309 58 32 (многоканальный)

**Факс:** 8 (812) 320-02-42

**Электронная почта:** [org@eplast1.ru](mailto:org@eplast1.ru)

**Адрес:** 198099, г. Санкт-Петербург, ул. Калинина, дом 2, корпус 4, литера А.