

GaN Bias Controller/Sequencer Module Dual Supply: -8 to -3 V, +12 to +55 V

Rev. V2

Features

- Robust GaN Protection at Any Power Up/Power Down Sequence
- Fixed Gate Bias Voltage with Pulsed Drain Bias Voltage. Add-On Module Allows for Gate Pulsing
- Open Drain Output Current of ≤ 200 mA for External MOSFET Switch Drive
- Internal Thermistor or External Temperature Sensor Voltage for Gate Bias Sum
- 30 dB Typical EMI/RFI Rejection at All I/O Ports
- 6.60 x 22.48 mm² Package with 1 mm Pitch SMT Leads
- Target ≤ 500 ns Total Switch Transition Time
- Gate Bias Output Current ≤ 50 mA for Heavy RF Compression
- RoHS* Compliant and 260°C Reflow Compatible



Description

The MABC-001000-DP000L is a bias controller that provides proper gate voltage and pulsed drain voltage biasing for a device under test (DUT). Applicable DUT's would be depletion-mode GaN (Gallium Nitride) or GaAs (Gallium Arsenide) power amplifiers or HEMT devices.

The module also provides bias sequencing so that pulsed drain voltage cannot be applied to a DUT unless the negative gate bias voltage is present.

The applications section of this datasheet will show how the module can be implemented for the following two applications:

- Application Option 1: Fixed negative gate biasing with pulsed drain biasing.
- Application Option 2: Pulsed negative gate biasing with pulsed drain biasing.

Both of these applications will recommend the external circuitry and p-Channel Power MOSFET.

The MABC-001000-DP000L module can also be installed onto an MABC-001000-PB1PPR evaluation board for evaluation, test, and characterization purposes.

Functional Schematic

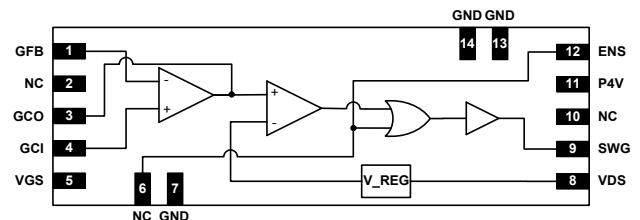

Pin Configuration¹

| Pin No. | Label | Function |
|---------|-------|---------------------------------------|
| 1 | GFB | Gate Voltage (-) Feedback |
| 2 | NC | No Connect |
| 3 | GCO | Gate Voltage (-) Control Output |
| 4 | GCI | Gate Voltage (-) Control Input |
| 5 | VGS | Gate (-) Supply Voltage |
| 6 | NC | No Connect |
| 7 | GND | Ground |
| 8 | VDS | Drain (+) Supply Voltage |
| 9 | SWG | Driver Output to MOS Switch Gate |
| 10 | NC | No Connect |
| 11 | P4V | Auxiliary +4.3 V _{DC} Output |
| 12 | ENS | MOS Switch Enable TTL |
| 13 | GND | Ground |
| 14 | GND | Ground |

1. Unused package pins must be left open and not connected to ground.

Ordering Information²

| Part Number | Packaging |
|--------------------|---|
| MABC-001000-DP000L | Tray |
| MABC-001000-DP00TL | Tape & Reel |
| MABC-001000-PB1PPR | Gate and Drain Pulsing Evaluation Board |

2. Reference Application Note M513 for reel size information.

* Restrictions on Hazardous Substances, European Union Directive 2002/95/EC.

GaN Bias Controller/Sequencer Module Dual Supply: -8 to -3 V, +12 to +55 V

Rev. V2

Electrical Characteristics: $T_A = 25^\circ\text{C}$

| Symbol | Parameter | Conditions | Min | Typ | Max | Unit |
|-----------|---|---|-----|--------------|-----|----------|
| V_{DS} | Supply Voltage, Positive | | 10 | 50 | 70 | V |
| I_{DS} | Supply Current, Positive | | - | 14 | - | mA |
| V_{GS} | Supply Voltage, Negative | | -8 | -6 | 0 | V |
| I_{GS} | Supply Current, Negative | | - | -3 | - | mA |
| V_{ENL} | ENS Input Voltage, Low | | 0 | 0 | 0.3 | V |
| V_{ENH} | ENS Input Voltage, High | | 2 | 3.3 | 4.3 | V |
| I_{ENS} | ENS Input Current | | - | 40 | - | uA |
| V_{GTH} | Input, Gate Feedback Threshold to V_{GS} | | - | 2.7 | - | V |
| V_{DTH} | Input, Drain Feedback Threshold | | - | 65% V_{DS} | - | V |
| V_{GC} | Output Voltage, Pulsed/Fixed Gate | | -8 | -3.5 | 0 | V |
| V_{GCR} | Output Voltage, Pulsed/Fixed Gate Ripple (Peak-to-peak) | | - | 50 | - | mV |
| I_{GC} | Output Gate Current, Peak | | - | 50 | - | mA |
| R_{OFF} | Output Drive, Open Drain, OFF State | $V_{DS} = 50\text{ V}$ Temp. = $+85^\circ\text{C}$ | - | 4M | - | Ω |
| R_{ON} | Output Drive, Open Drain, ON State | | - | 1.2 | - | Ω |
| I_{ON} | Output Drive, Current, ON State | | - | 100 | 200 | mA |

Absolute Maximum Ratings

| Parameter | Min. | Max. |
|---------------------------------|--------|---------|
| Supply (+) Voltage, V_{DS} | 0 V | +60 V |
| Supply (-) Voltage, V_{GS} | -10 V | 0 V |
| Logic Voltage, ENS, GSE | -0.3 V | +4.5 |
| Analog (-) Voltage, GCI, GFB | -10 V | 0 V |
| Switch Driver Voltage, SWG | 0 V | +75 V |
| Switch Driver Sink Current, SWG | - | -200 mA |
| Lead Soldering Temp (10 s) | - | +260°C |
| Operating Temperature | -40°C | +85°C |
| Storage Temperature | -65°C | +150°C |

Recommended Operating Conditions

| Parameter | Typical |
|---------------------------------|------------------|
| Supply (+) Voltage, V_{DS} | +12 V to +55 V |
| Supply (-) Voltage, V_{GS} | -8 V to -2 V |
| Logic Voltage, ENS | 0 V to +4.3 V |
| Analog (-) Voltage, GCI, GFB | -8 V to -2 V |
| Switch Driver Sink Current, SWG | -1 mA to -200 mA |
| Operating Temperature | -40°C to +85°C |

Timing Characteristics: $T_A = 25^\circ\text{C}$

| Symbol | Parameter | Conditions | Min | Typ | Max | Unit |
|-------------|---|--|-----|-----|-----|---------------|
| t_{D1} | Open Drain ON Propagation Delay ³ | $R_{PULL-UP} = 700 \Omega$ $V_{DS} = 50 \text{ V}$ $I_R = 71 \text{ mA avg.}$ Switch Disconnected | - | 100 | - | ns |
| t_{D3} | Open Drain OFF Propagation Delay ³ | | - | 70 | - | ns |
| t_{RISE1} | Open Drain Rise Time ⁴ | | - | 115 | - | ns |
| t_{FALL1} | Open Drain Fall Time ⁴ | | - | 60 | - | ns |
| t_{D1} | MOS Switch ON Propagation Delay ^{3,5} | $V_{DS} = 50 \text{ V}$ $MOS C_{ISS} = 2780 \text{ pF}$ $R_{DS,ON} = 60 \text{ m}\Omega$ | - | 300 | - | ns |
| t_{D3} | MOS Switch OFF Propagation Delay ^{3,5} | | - | 1.8 | - | μs |
| t_{RISE1} | MOS Switch Rise Time ^{4,5} | | - | 400 | - | ns |
| t_{FALL1} | MOS Switch Fall Time ^{4,5} | | - | 80 | - | μs |
| t_{D2} | Gate Bias ON Propagation Delay ^{3,5} | | - | 100 | - | ns |
| t_{D4} | Gate Bias OFF Propagation Delay ^{3,5} | | - | 200 | - | ns |
| t_{RISE2} | Gate Bias Rise Time ^{4,5} | | - | 500 | - | ns |
| t_{FALL2} | Gate Bias Fall Time ^{4,5} | | - | 400 | - | ns |

3. Propagation delay is measured from 90% of the TTL signal to 10% of the signal of interest.
4. Rise and fall times are measured between 10% and 90% of the steady state signal.
5. Parameter was measured with MABC-001000-PB1PPR sample board. MAGX-L21214-650L00 was used as the DUT.

Timing Diagrams

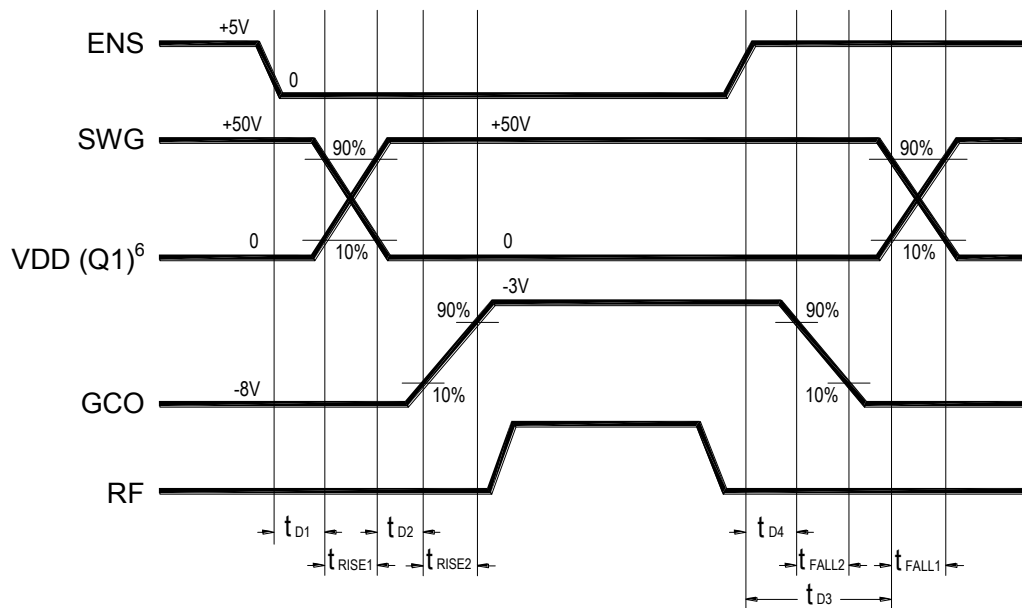

6. Q1 refers to an external p-Channel HEXFET that pulses the drain of the DUT. See Applications Section for more information.

Applications Section

Functional Description

The MABC-001000-DP000L GaN Bias Controller/ Sequencer Module circuitry provides proper sequencing and generation of the gate voltage and pulsed drain voltage for a device under test (DUT). Reference the Product View and Pin Configuration table on page 1. The basic functions of the circuits within the module are described as follows:

- Overhead Voltages for the Circuits within the MABC-001000-DP000L Module
 - Pin 8 (VDS) is the Drain (+) Supply Voltage that provides the input voltage to a low drop-out linear regulator (VREG). This supplies the positive voltage for the circuits within the module. It also provides the Auxiliary +4.3 V Output to Pin 11 (P4V).
 - Pin 5 (VGS) is the Gate (-) Supply Voltage that is also used to supply the negative voltage for the circuits within the module.
- Negative Gate Voltage for the Device Under Test (DUT)
 - A voltage follower op-amp circuit provides a low impedance output to Pin 3 (GCO) Gate Voltage (-) Control Output. Pin 3 (GCO) output is applied to the gate terminal of a DUT as shown in Figure 1 on page 5.
 - The reference voltage for the voltage follower is provided by the Pin 4 (GCI) Gate Voltage (-) Analog Input. This input reference voltage is developed by an external potentiometer/ resistive divider circuit as shown in Figure 1 on page 6. It is recommended to use the -8 V to -3 V voltage that is also applied to Pin 5 (VGS).
 - Reference: The external potentiometer is adjusted to set the gate voltage Pin 3 (GCO) to the DUT. Alternative voltage inputs such as a temperature compensation circuit or a Digital-to-Analog (DAC) converter could also be supplied to Pin 4 (GCI).
- Pin 9 (SWG) MOS Switch Driver Output
 - An N-Channel MOSFET develops the pulsed signal (SWG) to drive the resistive divider network for the gate of an external p-Channel HEXFET as shown in Figure 1 on page 5. The input signal for the internal MOSFET is provided by the output from the sequencing circuits.
- Sequencing Circuits
 - A voltage comparator circuit senses if the negative gate voltage is present as an input on Pin 1 (GFB) - Gate Voltage (-) Feedback.
 - A logic circuit provides the switched input enable signal for the N-Channel MOSFET. The following 3 signals must be at correct levels to generate the enable logic signal:
 - Pin 12 (ENS) MOS Switch Enable TTL
 - Negative gate voltage (GFB) is present
 - The internal positive voltage output is present from V_REG

Applications Section

Application Option 2: Pulsed Negative Gate Biasing with Pulsed Drain Biasing

A block diagram showing a typical application of the MABC-001000-PB1PPR sample board is shown in Figure 2 below. Figures 3 and 4 show layouts of the MABC-001000-PB1PPR sample board with/without the MABC-001000-DP000L module installed.

The additional external circuitry on the MABC-001000-PB1PPR sample board provides the added capability of pulsed gate biasing. A full schematic, layout, and bill of materials are available upon request.

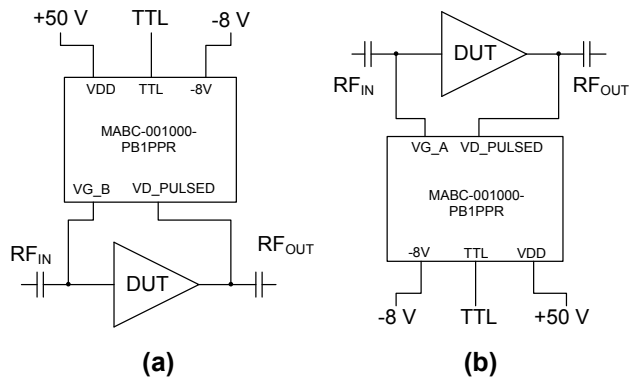

Figure 2. Pulsed Gate/Pulsed Drain Biasing:
 (a) North Biasing; (b) South Biasing

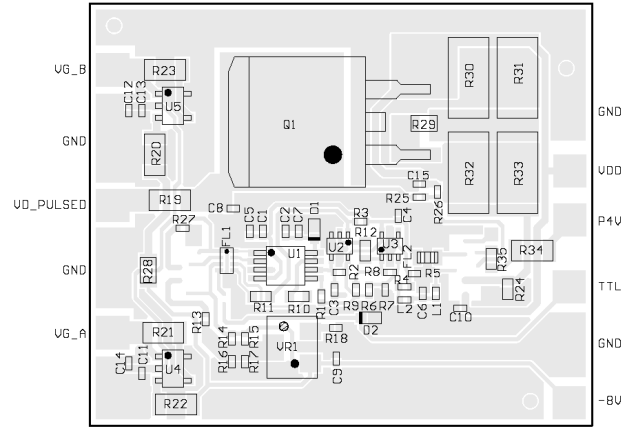

Figure 3. Populated MABC-001000-PB1PPR Evaluation Board

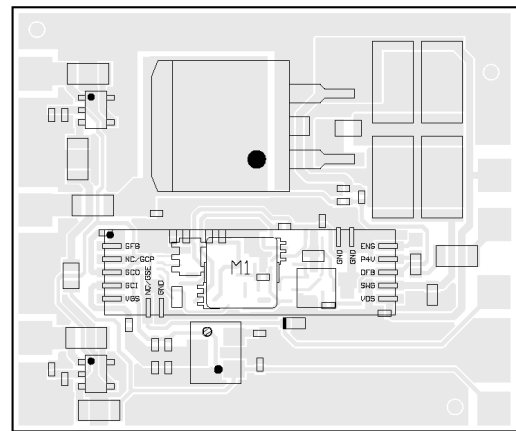
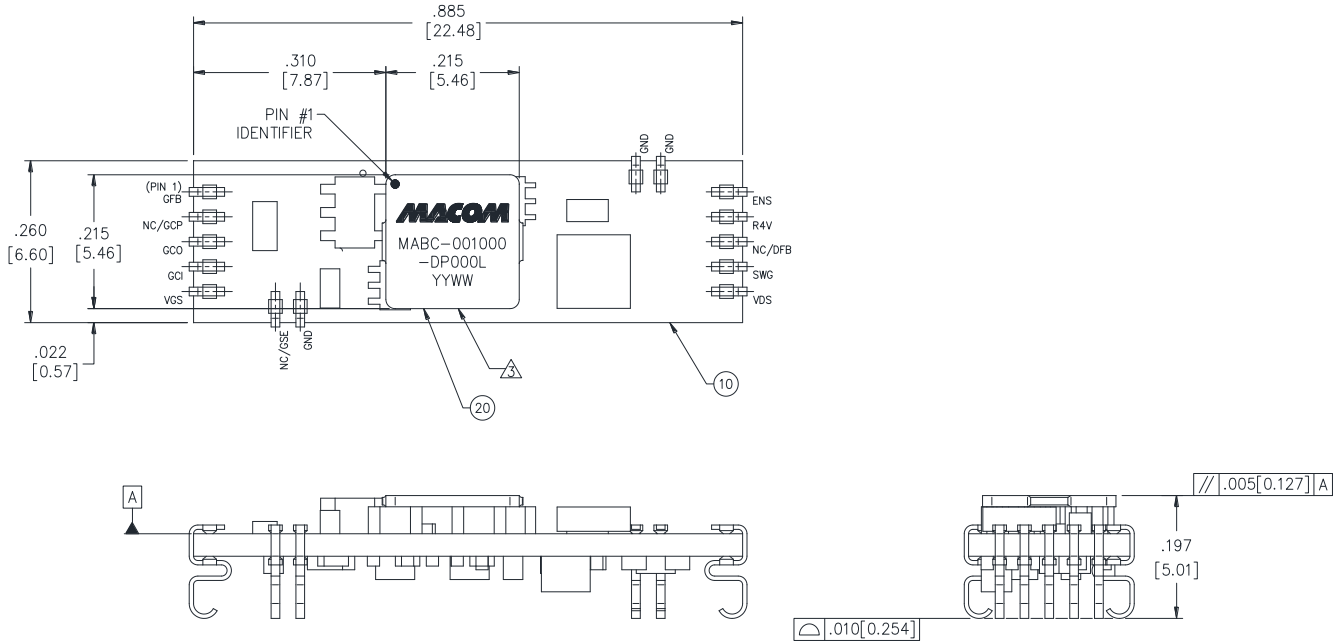
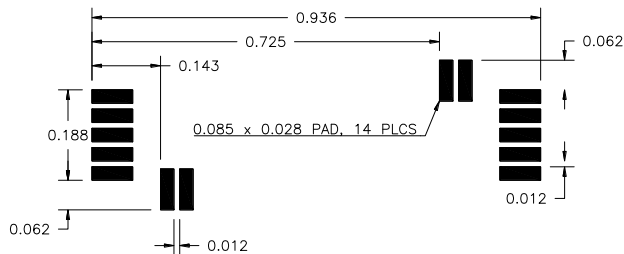

Figure 4. MABC-001000-PB1PPR with MABC-001000-DP000L Mounted

Physical Dimensions^{6,7,8}



Recommended Landing Pattern⁶



7. All dimensions are in inches.
8. Reference Application Note M538 for lead-free solder reflow recommendations.
9. Plating is 100% Sn over BeCu.

Handling Procedures

Please observe the following precautions to avoid damage:

Static Sensitivity

This module is sensitive to electrostatic discharge (ESD) and can be damaged by static electricity. Proper ESD control techniques should be used when handling these HBM class 1B devices.

M/A-COM Technology Solutions Inc. All rights reserved.

Information in this document is provided in connection with M/A-COM Technology Solutions Inc ("MACOM") products. These materials are provided by MACOM as a service to its customers and may be used for informational purposes only. Except as provided in MACOM's Terms and Conditions of Sale for such products or in any separate agreement related to this document, MACOM assumes no liability whatsoever. MACOM assumes no responsibility for errors or omissions in these materials. MACOM may make changes to specifications and product descriptions at any time, without notice. MACOM makes no commitment to update the information and shall have no responsibility whatsoever for conflicts or incompatibilities arising from future changes to its specifications and product descriptions. No license, express or implied, by estoppel or otherwise, to any intellectual property rights is granted by this document.

THESE MATERIALS ARE PROVIDED "AS IS" WITHOUT WARRANTY OF ANY KIND, EITHER EXPRESS OR IMPLIED, RELATING TO SALE AND/OR USE OF MACOM PRODUCTS INCLUDING LIABILITY OR WARRANTIES RELATING TO FITNESS FOR A PARTICULAR PURPOSE, CONSEQUENTIAL OR INCIDENTAL DAMAGES, MERCHANTABILITY, OR INFRINGEMENT OF ANY PATENT, COPYRIGHT OR OTHER INTELLECTUAL PROPERTY RIGHT. MACOM FURTHER DOES NOT WARRANT THE ACCURACY OR COMPLETENESS OF THE INFORMATION, TEXT, GRAPHICS OR OTHER ITEMS CONTAINED WITHIN THESE MATERIALS. MACOM SHALL NOT BE LIABLE FOR ANY SPECIAL, INDIRECT, INCIDENTAL, OR CONSEQUENTIAL DAMAGES, INCLUDING WITHOUT LIMITATION, LOST REVENUES OR LOST PROFITS, WHICH MAY RESULT FROM THE USE OF THESE MATERIALS.

MACOM products are not intended for use in medical, lifesaving or life sustaining applications. MACOM customers using or selling MACOM products for use in such applications do so at their own risk and agree to fully indemnify MACOM for any damages resulting from such improper use or sale.



Компания «ЭлектроПласт» предлагает заключение долгосрочных отношений при поставках импортных электронных компонентов на взаимовыгодных условиях!

Наши преимущества:

- Оперативные поставки широкого спектра электронных компонентов отечественного и импортного производства напрямую от производителей и с крупнейших мировых складов;
- Поставка более 17-ти миллионов наименований электронных компонентов;
- Поставка сложных, дефицитных, либо снятых с производства позиций;
- Оперативные сроки поставки под заказ (от 5 рабочих дней);
- Экспресс доставка в любую точку России;
- Техническая поддержка проекта, помощь в подборе аналогов, поставка прототипов;
- Система менеджмента качества сертифицирована по Международному стандарту ISO 9001;
- Лицензия ФСБ на осуществление работ с использованием сведений, составляющих государственную тайну;
- Поставка специализированных компонентов (Xilinx, Altera, Analog Devices, Intersil, Interpoint, Microsemi, Aeroflex, Peregrine, Syfer, Eurofarad, Texas Instrument, Miteq, Cobham, E2V, MA-COM, Hittite, Mini-Circuits, General Dynamics и др.);

Помимо этого, одним из направлений компании «ЭлектроПласт» является направление «Источники питания». Мы предлагаем Вам помощь Конструкторского отдела:

- Подбор оптимального решения, техническое обоснование при выборе компонента;
- Подбор аналогов;
- Консультации по применению компонента;
- Поставка образцов и прототипов;
- Техническая поддержка проекта;
- Защита от снятия компонента с производства.



Как с нами связаться

Телефон: 8 (812) 309 58 32 (многоканальный)

Факс: 8 (812) 320-02-42

Электронная почта: org@eplast1.ru

Адрес: 198099, г. Санкт-Петербург, ул. Калинина, дом 2, корпус 4, литера А.