



FEATURES

- UL 60950 Recognized
- RoHS compliant
- Efficiency to 89% (Typ.)
- Power density to 0.85W/cm³
- Wide temperature performance at full 1 Watt load, -40°C to 85°C
- UL 94V-0 package material
- No heatsink required
- Industry standard pinout
- 3kVDC isolation (1 minute)
- 5V, 12V, 15V, 24V, & 48V inputs
- 5V, 9V, 12V, & 15V output
- Fully encapsulated with toroidal magnetics
- No external components required
- No electrolytic or tantalum capacitors

PRODUCT OVERVIEW

The MEV series is the new high performance version of our 1W NMV series. The MEV series is more efficient and offers improved regulation performance from 1.8% for applications where a wide output voltage variation can not be tolerated. They are ideally suited for providing local supplies on control system boards with the added benefit of 3kVDC galvanic isolation to reduce switching noise. The MEV series is currently available in an industry SIP 7 or DIP 14 package.

SELECTION GUIDE - SINGLE OUTPUT¹

| Order Code | Nominal Input Voltage | Output Voltage | Output Current | Input Current at Rated Load | Load Regulation (Typ) | Load Regulation (Max) | Ripple & Noise (Typ) ² | Ripple & Noise (Max) ² | Efficiency (Min) | Efficiency (Typ) | Isolation Capacitance | MTTF ³ | Package Style |
|-------------|-----------------------|----------------|----------------|-----------------------------|-----------------------|-----------------------|-----------------------------------|-----------------------------------|------------------|------------------|-----------------------|-------------------|---------------|
| | V | V | mA | | % | % | mVp-p | mVp-p | % | % | pF | kHrs | |
| MEV1S0505SC | 5 | 5 | 200 | 233 | 5.4 | 6.2 | 20 | 30 | 81 | 84 | 38 | 7684 | SIP |
| MEV1S0509SC | 5 | 9 | 111 | 227 | 4.2 | 5.5 | 12 | 20 | 83.5 | 86.5 | 42 | 7698 | SIP |
| MEV1S0512SC | 5 | 12 | 84 | 226 | 4.6 | 5.5 | 10 | 20 | 84 | 87 | 40 | 7175 | SIP |
| MEV1S0515SC | 5 | 15 | 67 | 225 | 4.5 | 5 | 8 | 15 | 85 | 87.5 | 39 | 6496 | SIP |
| MEV1S1205SC | 12 | 5 | 200 | 98 | 4.5 | 5 | 12 | 15 | 80 | 84 | 28 | 7569 | SIP |
| MEV1S1209SC | 12 | 9 | 111 | 96 | 3 | 3.3 | 8 | 15 | 83 | 86 | 50 | 7317 | SIP |
| MEV1S1212SC | 12 | 12 | 84 | 94 | 3 | 3.6 | 7 | 15 | 85.5 | 88 | 70 | 6647 | SIP |
| MEV1S1215SC | 12 | 15 | 67 | 94 | 2.5 | 2.9 | 7 | 15 | 83.5 | 88 | 59 | 6279 | SIP |
| MEV1S1505SC | 15 | 5 | 200 | 79 | 4 | 5 | 10 | 20 | 80 | 83.5 | 32 | 7167 | SIP |
| MEV1S1509SC | 15 | 9 | 111 | 77 | 2.5 | 3.5 | 8 | 20 | 82.5 | 86.5 | 52 | 6906 | SIP |
| MEV1S1512SC | 15 | 12 | 84 | 76 | 2.3 | 3.5 | 6 | 15 | 83.5 | 87.5 | 63 | 6523 | SIP |
| MEV1S1515SC | 15 | 15 | 67 | 76 | 2.5 | 3.5 | 6 | 15 | 85 | 89 | 87 | 5916 | SIP |
| MEV1S2405SC | 24 | 5 | 200 | 50 | 3.3 | 5 | 12 | 20 | 79 | 84 | 38 | 7391 | SIP |
| MEV1S2409SC | 24 | 9 | 111 | 48 | 2.2 | 3.5 | 8 | 20 | 81 | 86.5 | 56 | 6490 | SIP |
| MEV1S2412SC | 24 | 12 | 84 | 48 | 2 | 3.5 | 7 | 15 | 82 | 87.5 | 72 | 6772 | SIP |
| MEV1S2415SC | 24 | 15 | 67 | 48 | 1.8 | 3 | 7 | 15 | 82 | 87.5 | 83 | 5957 | SIP |
| MEV1S4805SC | 48 | 5 | 200 | 26 | 3.3 | 5 | 19 | 35 | 75.5 | 79.5 | 34 | 7354 | SIP |
| MEV1S4809SC | 48 | 9 | 111 | 25 | 2.4 | 3.5 | 13 | 25 | 78.5 | 82 | 54 | 7120 | SIP |
| MEV1S4812SC | 48 | 12 | 84 | 26 | 2 | 3 | 10 | 20 | 78 | 82 | 63 | 7088 | SIP |
| MEV1S4815SC | 48 | 15 | 67 | 26 | 1.9 | 3 | 9 | 20 | 79 | 82.5 | 74 | 7238 | SIP |
| MEV1S0505DC | 5 | 5 | 200 | 234 | 5.4 | 6.5 | 15 | 30 | 81 | 84 | 39 | 6884 | DIP |
| MEV1S0509DC | 5 | 9 | 111 | 228 | 4.2 | 5.5 | 9 | 20 | 83 | 86.5 | 40 | 6732 | DIP |
| MEV1S0512DC | 5 | 12 | 84 | 228 | 5.0 | 5.7 | 8 | 15 | 84 | 87 | 39 | 6153 | DIP |
| MEV1S0515DC | 5 | 15 | 67 | 226 | 4.4 | 5.5 | 8 | 15 | 84 | 87.5 | 38 | 5419 | DIP |
| MEV1S1205DC | 12 | 5 | 200 | 98 | 4.6 | 5.5 | 11 | 20 | 80 | 84 | 34 | 6644 | DIP |
| MEV1S1209DC | 12 | 9 | 111 | 96 | 3 | 3.5 | 8 | 15 | 82 | 86 | 50 | 6434 | DIP |
| MEV1S1212DC | 12 | 12 | 84 | 93 | 3.1 | 3.7 | 7 | 15 | 84 | 88 | 52 | 5653 | DIP |
| MEV1S1215DC | 12 | 15 | 67 | 94 | 2.5 | 3.3 | 6 | 15 | 83 | 88 | 60 | 5267 | DIP |
| MEV1S1505DC | 15 | 5 | 200 | 79 | 4 | 5.2 | 11 | 25 | 79 | 83.5 | 32 | 6332 | DIP |
| MEV1S1509DC | 15 | 9 | 111 | 77 | 2.6 | 3.3 | 7 | 20 | 81 | 86.5 | 52 | 6114 | DIP |
| MEV1S1512DC | 15 | 12 | 84 | 76 | 2.3 | 3 | 6 | 15 | 83 | 87.5 | 63 | 5767 | DIP |
| MEV1S1515DC | 15 | 15 | 67 | 75 | 2.5 | 3.2 | 6 | 15 | 84 | 89 | 87 | 5002 | DIP |
| MEV1S2405DC | 24 | 5 | 200 | 50 | 3.4 | 4.5 | 16 | 30 | 79 | 84 | 38 | 6488 | DIP |
| MEV1S2409DC | 24 | 9 | 111 | 48 | 2.3 | 3.3 | 9 | 20 | 82 | 86.5 | 55 | 5693 | DIP |
| MEV1S2412DC | 24 | 12 | 84 | 48 | 2 | 3 | 7 | 15 | 83 | 87.5 | 73 | 5736 | DIP |
| MEV1S2415DC | 24 | 15 | 67 | 48 | 1.8 | 3 | 6 | 15 | 83 | 87.5 | 84 | 4915 | DIP |

1. For dual output variants, see page 2.
2. See Ripple & Noise characterisation method.
3. Calculated using MIL-HDBK-217F FN2 with nominal input voltage at full load.

All specifications typical at T_A=25°C, nominal input voltage and rated output current unless otherwise specified.



SELECTION GUIDE - DUAL OUTPUT¹

| Order Code | Nominal Input Voltage | Output Voltage | Output Current | Input Current at Rated Load | Load Regulation (Typ) | Load Regulation (Max) | Ripple & Noise (Typ) ² | | Efficiency (Min) | Efficiency (Typ) | Isolation Capacitance | MTTF ³ | Package Style |
|-------------|-----------------------|----------------|----------------|-----------------------------|-----------------------|-----------------------|-----------------------------------|----|------------------|------------------|-----------------------|-------------------|---------------|
| | V | V | mA | | % | % | mVp-p | | % | % | pF | kHrs | |
| MEV1D0505SC | 5 | ±5 | ±100 | 233 | 5.1 | 6.5 | 14 | 35 | 82 | 85 | 42 | TBA | SIP |
| MEV1D0509SC | 5 | ±9 | ±56 | 228 | 4.1 | 5.2 | 11 | 30 | 84 | 87 | 42 | TBA | SIP |
| MEV1D0512SC | 5 | ±12 | ±42 | 228 | 4.2 | 5.4 | 9 | 25 | 85 | 87.5 | 38 | TBA | SIP |
| MEV1D0515SC | 5 | ±15 | ±33 | 225 | 4.0 | 5.2 | 9 | 25 | 85 | 88 | 38 | TBA | SIP |
| MEV1D1205SC | 12 | ±5 | ±100 | 98 | 3.8 | 4.5 | 13 | 35 | 81 | 85 | 33 | TBA | SIP |
| MEV1D1209SC | 12 | ±9 | ±56 | 95 | 2.7 | 3.5 | 10 | 25 | 83 | 87 | 53 | TBA | SIP |
| MEV1D1212SC | 12 | ±12 | ±42 | 93 | 2.7 | 3.4 | 8 | 20 | 85 | 89.5 | 64 | TBA | SIP |
| MEV1D1215SC | 12 | ±15 | ±33 | 94 | 2.2 | 3 | 7 | 20 | 85 | 88.5 | 74 | TBA | SIP |
| MEV1D1505SC | 15 | ±5 | ±100 | 78 | 3.3 | 4.0 | 14 | 35 | 81 | 84.5 | 33 | TBA | SIP |
| MEV1D1509SC | 15 | ±9 | ±56 | 76 | 2.2 | 2.9 | 10 | 30 | 83 | 87 | 47 | TBA | SIP |
| MEV1D1512SC | 15 | ±12 | ±42 | 76 | 2.1 | 3.0 | 8 | 25 | 84 | 88 | 67 | TBA | SIP |
| MEV1D1515SC | 15 | ±15 | ±33 | 75 | 2.3 | 3.0 | 7 | 20 | 87 | 90.5 | 112 | TBA | SIP |
| MEV1D2405SC | 24 | ±5 | ±100 | 49 | 2.9 | 4.0 | 13 | 35 | 81 | 84 | 36 | TBA | SIP |
| MEV1D2409SC | 24 | ±9 | ±56 | 47 | 1.9 | 2.7 | 12 | 35 | 83 | 86 | 52 | TBA | SIP |
| MEV1D2412SC | 24 | ±12 | ±42 | 47 | 1.8 | 2.7 | 10 | 30 | 85 | 88 | 78 | TBA | SIP |
| MEV1D2415SC | 24 | ±15 | ±33 | 47 | 1.5 | 2.4 | 9 | 25 | 84 | 88 | 81 | TBA | SIP |
| MEV1D4805SC | 48 | ±5 | ±100 | 26 | 2.6 | 3.3 | 21 | 50 | 77 | 80 | 32 | TBA | SIP |
| MEV1D4809SC | 48 | ±9 | ±56 | 25 | 1.6 | 2.4 | 14 | 40 | 80 | 83 | 54 | TBA | SIP |
| MEV1D4812SC | 48 | ±12 | ±42 | 25 | 1.4 | 2.2 | 13 | 35 | 81 | 84 | 79 | TBA | SIP |
| MEV1D4815SC | 48 | ±15 | ±33 | 25 | 1.3 | 2.2 | 12 | 30 | 82 | 85 | 79 | TBA | SIP |
| MEV1D0505DC | 5 | ±5 | ±100 | 233 | 5.1 | 6.5 | 14 | 35 | 82 | 85 | 42 | TBA | DIP |
| MEV1D0509DC | 5 | ±9 | ±56 | 228 | 4.1 | 5.2 | 11 | 30 | 84 | 87 | 42 | TBA | DIP |
| MEV1D0512DC | 5 | ±12 | ±42 | 228 | 4.2 | 5.4 | 9 | 25 | 85 | 87.5 | 38 | TBA | DIP |
| MEV1D0515DC | 5 | ±15 | ±33 | 225 | 4.0 | 5.2 | 9 | 25 | 85 | 88 | 38 | TBA | DIP |
| MEV1D1205DC | 12 | ±5 | ±100 | 98 | 3.8 | 4.5 | 13 | 35 | 81 | 85 | 33 | TBA | DIP |
| MEV1D1209DC | 12 | ±9 | ±56 | 95 | 2.7 | 3.5 | 10 | 25 | 83 | 87 | 53 | TBA | DIP |
| MEV1D1212DC | 12 | ±12 | ±42 | 93 | 2.7 | 3.4 | 8 | 20 | 85 | 89.5 | 64 | TBA | DIP |
| MEV1D1215DC | 12 | ±15 | ±33 | 94 | 2.2 | 3 | 7 | 20 | 85 | 88.5 | 74 | TBA | DIP |
| MEV1D1505DC | 15 | ±5 | ±100 | 78 | 3.3 | 4 | 14 | 35 | 81 | 84.5 | 33 | TBA | DIP |
| MEV1D1509DC | 15 | ±9 | ±56 | 76 | 2.2 | 2.9 | 10 | 30 | 83 | 87 | 47 | TBA | DIP |
| MEV1D1512DC | 15 | ±12 | ±42 | 76 | 2.1 | 3.0 | 8 | 25 | 84 | 88 | 67 | TBA | DIP |
| MEV1D1515DC | 15 | ±15 | ±33 | 75 | 2.3 | 3.0 | 7 | 20 | 87 | 90.5 | 112 | TBA | DIP |
| MEV1D2405DC | 24 | ±5 | ±100 | 49 | 2.9 | 4 | 13 | 35 | 81 | 84 | 36 | TBA | DIP |
| MEV1D2409DC | 24 | ±9 | ±56 | 47 | 1.9 | 2.7 | 12 | 35 | 83 | 86 | 52 | TBA | DIP |
| MEV1D2412DC | 24 | ±12 | ±42 | 47 | 1.8 | 2.7 | 10 | 30 | 85 | 88 | 78 | TBA | DIP |
| MEV1D2415DC | 24 | ±15 | ±33 | 47 | 1.5 | 2.4 | 9 | 25 | 85 | 87.5 | 81 | TBA | DIP |

1. For single output variants, see page 1.
2. See Ripple & Noise characterisation method.
3. Calculated using MIL-HDBK-217F FN2 with nominal input voltage at full load.

All specifications typical at T_a=25°C, nominal input voltage and rated output current unless otherwise specified.

| INPUT CHARACTERISTICS | | | | | |
|--------------------------|---------------------------------------|------|------|------|--------|
| Parameter | Conditions | Min. | Typ. | Max. | Units |
| Voltage range | Continuous operation, 5V input types | 4.5 | 5 | 5.5 | V |
| | Continuous operation, 12V input types | 10.8 | 12 | 13.2 | |
| | Continuous operation, 15V input types | 13.5 | 15 | 16.5 | |
| | Continuous operation, 24V input types | 21.6 | 24 | 26.4 | |
| | Continuous operation, 48V input types | 43.2 | 48 | 52.8 | |
| Reflected ripple current | 5V input types | | 11 | 20 | mA p-p |
| | 12V input types | | 5 | 15 | |
| | 15V input types | | 3.5 | 10 | |
| | 24V input types | | 4.7 | 15 | |
| | 48V input types | | 22 | 50 | |

| OUTPUT CHARACTERISTICS | | | | | |
|----------------------------|---|------|------|------|-------|
| Parameter | Conditions | Min. | Typ. | Max. | Units |
| Rated Power | T _A =-40°C to 85°C | | | 1 | W |
| Voltage Set Point Accuracy | See tolerance envelope | | | | |
| Line regulation | High V _{IN} to low V _{IN} | | 1.05 | 1.1 | %/% |

| ISOLATION CHARACTERISTICS | | | | | |
|---------------------------|---------------------------|------|------|------|-------|
| Parameter | Conditions | Min. | Typ. | Max. | Units |
| Isolation test voltage | Flash tested for 1 minute | 3000 | | | VDC |
| Resistance | Viso= 1000VDC | 10 | | | GΩ |

| GENERAL CHARACTERISTICS | | | | | |
|---|--|------|------|------|-------|
| Parameter | Conditions | Min. | Typ. | Max. | Units |
| Switching frequency - single output types | 5V input types | | 60 | | kHz |
| | 12V input types & MEV1Sx1515xC | | 75 | | |
| | 24V input types & MEV1Sx1505SxC, MEV1Sx1509SxC, MEV1Sx1512SxC | | 85 | | |
| | 48V input types | | 65 | | |
| Switching frequency - dual output types | MEV1D4812xC, MEV1D4815xC | | 55 | | |
| | MEV1D05xxC, MEV1D1212xC, MEV1D1515xC, MEV1D4805xC, MEV1D4809xC | | 60 | | |
| | MEV1D1205xC, MEV1D2412xC | | 75 | | |
| | MEV1D1209xC, MEV1D1215xC, MEV1D1505xC, MEV1D1512xC, MEV1D2405xC, MEV1D2415xC | | 80 | | |
| | MEV1D1509xC, MEV1D2409xC | | 90 | | |

| TEMPERATURE CHARACTERISTICS | | | | | |
|--------------------------------|-----------------------|------|------|------|-------|
| Parameter | Conditions | Min. | Typ. | Max. | Units |
| Specification | All output types | -40 | | 85 | °C |
| Storage | | -50 | | 125 | |
| Case Temperature above ambient | 24V & 48V input types | | | 20 | |
| | All other types | | | 15 | |
| Cooling | Free air convection | | | | |

| ABSOLUTE MAXIMUM RATINGS | |
|---|-------|
| Lead temperature 1.5mm from case for 10 seconds | 300°C |
| Input voltage V _{IN} , MEV05 types | 7V |
| Input voltage V _{IN} , MEV12 types | 15V |
| Input voltage V _{IN} , MEV15 types | 18V |
| Input voltage V _{IN} , MEV24 types | 28V |
| Input voltage V _{IN} , MEV48 types | 54V |

TEMPERATURE DERATING GRAPH

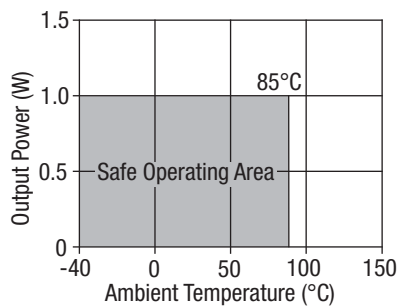

TOLERANCE ENVELOPE

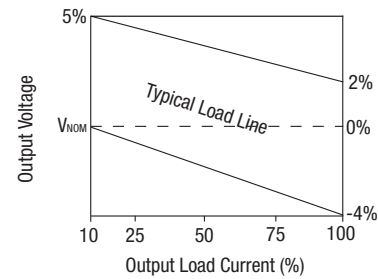

The voltage tolerance envelope shows typical load regulation characteristics for this product series. The tolerance envelope is the maximum output voltage variation due to changes in output loading.

TECHNICAL NOTES

ISOLATION VOLTAGE

'Hi Pot Test', 'Flash Tested', 'Withstand Voltage', 'Proof Voltage', 'Dielectric Withstand Voltage' & 'Isolation Test Voltage' are all terms that relate to the same thing, a test voltage, applied for a specified time, across a component designed to provide electrical isolation, to verify the integrity of that isolation.

Murata Power Solutions MEV1 series of DC/DC converters are all 100% production tested at their stated isolation voltage. This is 3kVDC for 1 minute.

A question commonly asked is, "What is the continuous voltage that can be applied across the part in normal operation?"

The MEV1 has been recognized by Underwriters Laboratory for functional insulation, both input and output should normally be maintained within SELV limits i.e. less than 42.4V peak, or 60VDC. The isolation test voltage represents a measure of immunity to transient voltages and the part should never be used as an element of a safety isolation system. The part could be expected to function correctly with several hundred volts offset applied continuously across the isolation barrier; but then the circuitry on both sides of the barrier must be regarded as operating at an unsafe voltage and further isolation/insulation systems must form a barrier between these circuits and any user-accessible circuitry according to safety standard requirements.

REPEATED HIGH-VOLTAGE ISOLATION TESTING

It is well known that repeated high-voltage isolation testing of a barrier component can actually degrade isolation capability, to a lesser or greater degree depending on materials, construction and environment. The MEV1 series has toroidal isolation transformers, with no additional insulation between primary and secondary windings of enameled wire. While parts can be expected to withstand several times the stated test voltage, the isolation capability does depend on the wire insulation. Any material, including this enamel (typically polyurethane) is susceptible to eventual chemical degradation when subject to very high applied voltages thus implying that the number of tests should be strictly limited. We therefore strongly advise against repeated high voltage isolation testing, but if it is absolutely required, that the voltage be reduced by 20% from specified test voltage.

This consideration equally applies to agency recognized parts rated for better than functional isolation where the wire enamel insulation is always supplemented by a further insulation system of physical spacing or barriers.

SAFETY APPROVAL

The MEV1 series has been recognized by Underwriters Laboratory (UL) to UL 60950 for functional insulation in a maximum still air ambient temperature of 85°C and/or case temperature limit (case temperature measured on the face opposite the pins) as follows:

- MEV1SxxxSC: 130°C
- MEV1SxxxDC: 130°C
- MEV1DxxxSC: 94°C
- MEV1DxxxDC: 96°C

The MEV1 Series of converters are not internally fused so to meet the requirements of UL 60950 an anti-surge input line fuse should always be used with ratings as defined below.

- MEV1x05xxxC: 1A
- MEV1x12xxxC: 0.375A
- MEV1x15xxxC: 0.375A
- MEV1x24xxxC: 0.2A
- MEV1x48xxxC: 0.1A

All fuses should be UL recognized and rated to at least the maximum allowable DC input voltage.

File number E179522 applies.

RoHS COMPLIANT INFORMATION



This series is compatible with RoHS soldering systems with a peak wave solder temperature of 300°C for 10 seconds. The pin termination finish on the SIP package type is Tin Plate, Hot Dipped over Matte Tin with Nickel Preplate. The DIP types are Matte Tin over Nickel Preplate. Both types in this series are backward compatible with Sn/Pb soldering systems. For further information, please visit www.murata-ps.com/rohs

APPLICATION NOTES

Minimum load

The minimum load to meet datasheet specification is 10% of the full rated load across the specified input voltage range. Lower than 10% minimum loading will result in an increase in output voltage, which may rise to typically double the specified output voltage if the output load falls to less than 5%.

Capacitive loading and start up

Typical start up times for this series, with a typical input voltage rise time of 2.2µs and output capacitance of 10µF, are shown in the table below. The product series will start into a capacitance of 47µF with an increased start time, however, the maximum recommended output capacitance is 10µF.

| | Start-up time µs | | Start-up time µs |
|-------------|---------------------|-------------|---------------------|
| MEV1x0505xC | 585 | MEV1x1512xC | 3045 |
| MEV1x0509xC | 1550 | MEV1x1515xC | 4445 |
| MEV1x0512xC | 2700 | MEV1x2405xC | 440 |
| MEV1x0515xC | 4320 | MEV1x2409xC | 4355 |
| MEV1x1205xC | 605 | MEV1x2412xC | 1855 |
| MEV1x1209xC | 1750 | MEV1x2415xC | 2930 |
| MEV1x1212xC | 3000 | MEV1x4805SC | 580 |
| MEV1x1215xC | 4800 | MEV1x4809SC | 1320 |
| MEV1x1505xC | 660 | MEV1x4812SC | 2075 |
| MEV1x1509xC | 1720 | MEV1x4815SC | 3235 |

Typical Start-Up Wave Form

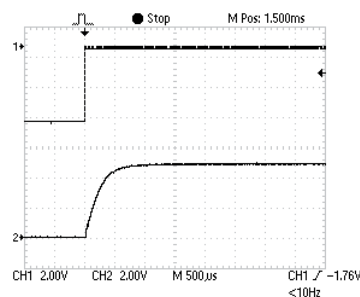

Ripple & Noise Characterisation Method

Ripple and noise measurements are performed with the following test configuration.

| | |
|-------|--|
| C1 | 1µF X7R multilayer ceramic capacitor, voltage rating to be a minimum of 3 times the output voltage of the DC/DC converter |
| C2 | 10µF tantalum capacitor, voltage rating to be a minimum of 1.5 times the output voltage of the DC/DC converter with an ESR of less than 100mΩ at 100 kHz |
| C3 | 100nF multilayer ceramic capacitor, general purpose |
| R1 | 450Ω resistor, carbon film, ±1% tolerance |
| R2 | 50Ω BNC termination |
| T1 | 3T of the coax cable through a ferrite toroid |
| RLOAD | Resistive load to the maximum power rating of the DC/DC converter. Connections should be made via twisted wires |

Measured values are multiplied by 10 to obtain the specified values.

Differential Mode Noise Test Schematic

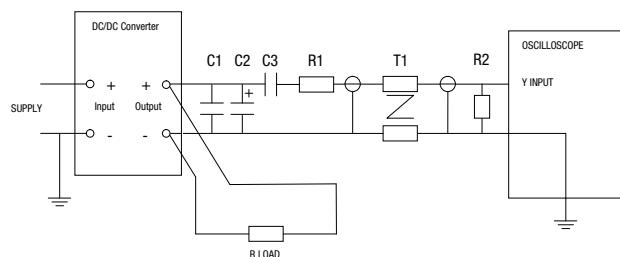

APPLICATION NOTES (continued)

Output Ripple Reduction

By using the values of inductance and capacitance stated, the output ripple at the rated load is lowered to 5mV p-p max.

Component selection

Capacitor: It is required that the ESR (Equivalent Series Resistance) should be as low as possible, ceramic types are recommended. The voltage rating should be at least twice (except for 15V output), the rated output voltage of the DC/DC converter.

Inductor: The rated current of the inductor should not be less than that of the output of the DC/DC converter. At the rated current, the DC resistance of the inductor should be such that the voltage drop across the inductor is <2% of the rated voltage of the DC/DC converter. The SRF (Self Resonant Frequency) should be >20MHz.

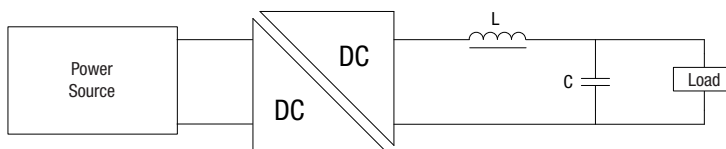

| | Inductor | | | Capacitor |
|-------------|------------|--------|--------------|------------|
| | L, μ H | SMD | Through Hole | C, μ F |
| MEV1x0505xC | 10 | 82103C | 11R103C | 4.7 |
| MEV1x0509xC | 22 | 82223C | 11R223C | 2.2 |
| MEV1x0512xC | 47 | 82473C | 11R473C | 1 |
| MEV1x0515xC | 47 | 82473C | 11R473C | 1 |
| MEV1x1205xC | 10 | 82103C | 11R103C | 4.7 |
| MEV1x1209xC | 22 | 82223C | 11R223C | 2.2 |
| MEV1x1212xC | 47 | 82473C | 11R473C | 1 |
| MEV1x1215xC | 47 | 82473C | 11R473C | 1 |
| MEV1x1505xC | 10 | 82103C | 11R103C | 4.7 |
| MEV1x1509xC | 22 | 82223C | 11R223C | 2.2 |
| MEV1x1512xC | 47 | 82473C | 11R473C | 1 |
| MEV1x1515xC | 47 | 82473C | 11R473C | 1 |
| MEV1x2405xC | 10 | 82103C | 11R103C | 4.7 |
| MEV1x2409xC | 22 | 82223C | 11R223C | 2.2 |
| MEV1x2412xC | 47 | 82473C | 11R473C | 1 |
| MEV1x2415xC | 47 | 82473C | 11R473C | 1 |
| MEV1x4805SC | 10 | 82103C | 11R103C | 4.7 |
| MEV1x4809SC | 22 | 82223C | 11R223C | 2.2 |
| MEV1x4812SC | 47 | 82473C | 11R473C | 1 |
| MEV1x4815SC | 47 | 82473C | 11R473C | 1 |

EFFICIENCY VS LOAD

MEV1x05xxSC

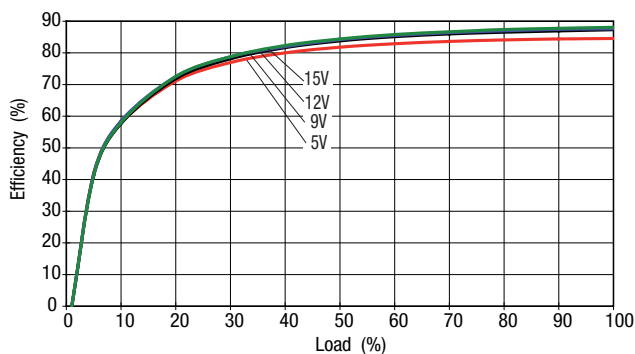

MEV1x12xxSC

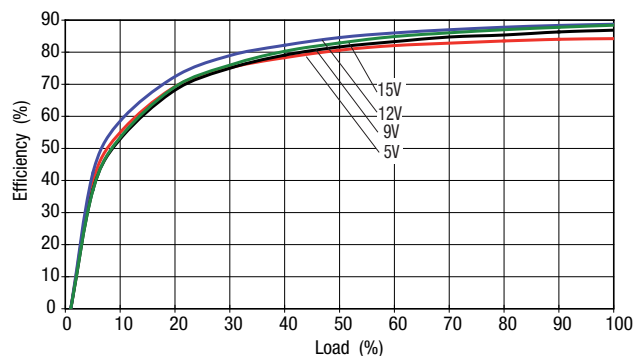

MEV1x15xxSC

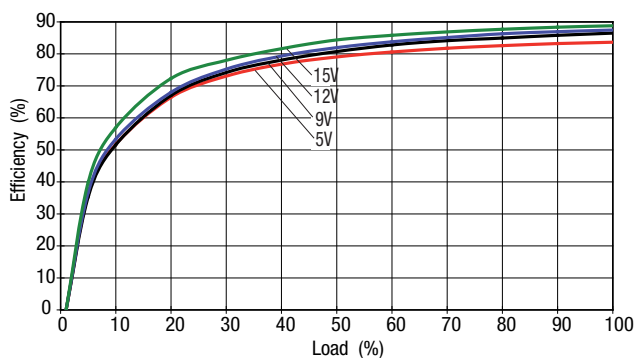

MEV1x24xxSC

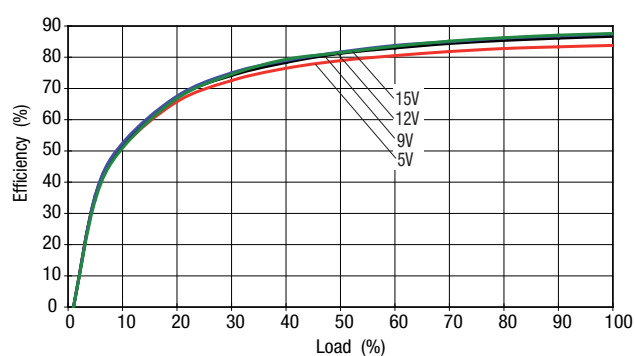

MEV1x48xxSC

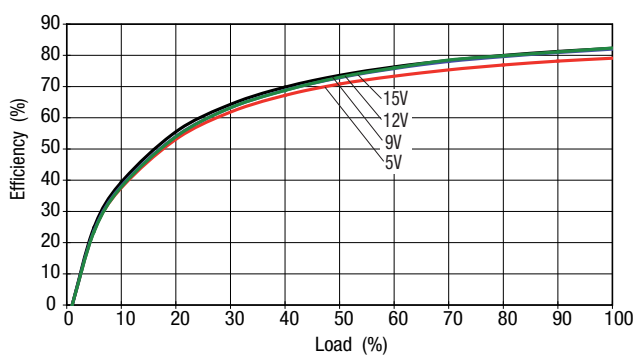

EFFICIENCY VS LOAD

MEV1x05xxDC

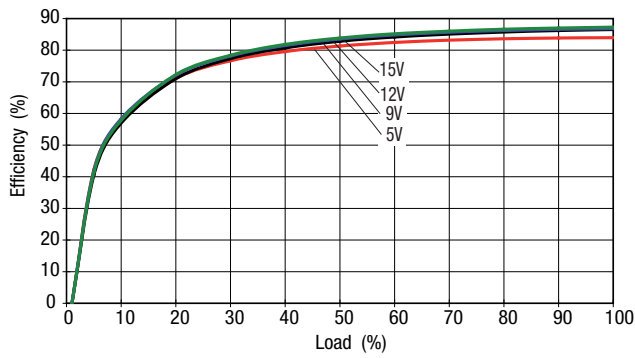

MEV1x12xxDC

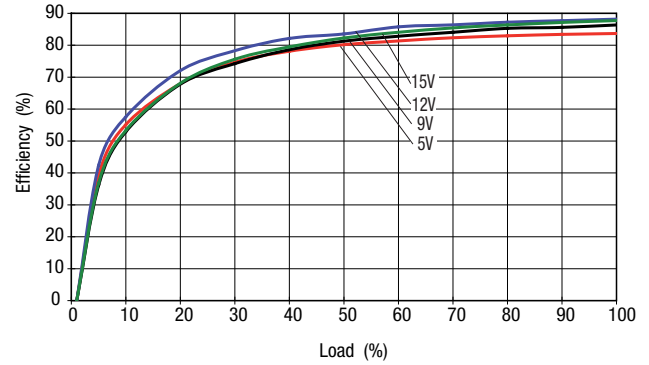

MEV1x15xxDC

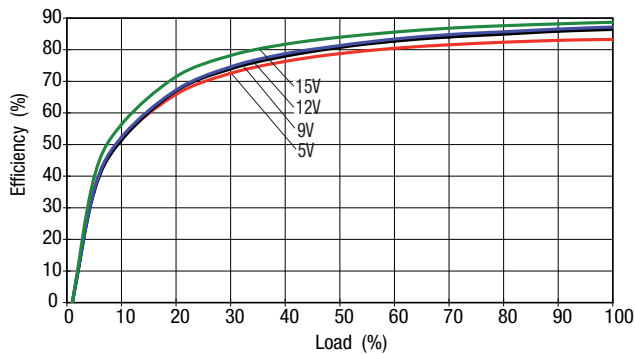

MEV1x24xxDC

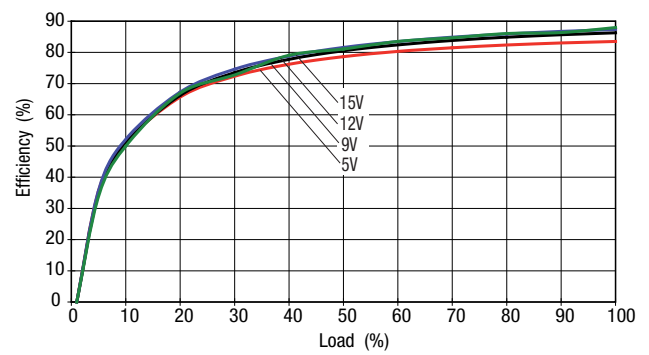

PACKAGE SPECIFICATIONS

MECHANICAL DIMENSIONS

DIP package



SIP package

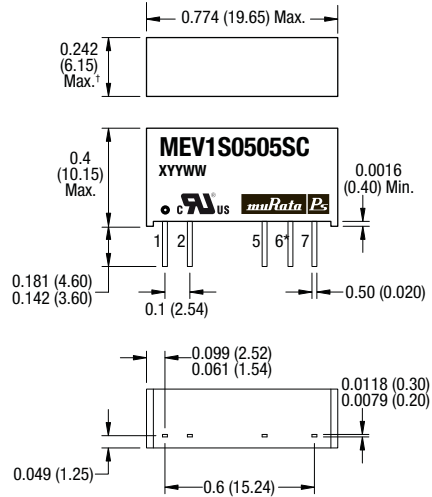

Weight:
2.6g (DIP)
2.8g (SIP - 48V variants)
2.5g (all other SIP)

* Pin not fitted on single output variants.

[†] 48V input variants 0.301 (7.65)

All dimensions in inches ± 0.01 (mm ± 0.25 mm). All pins on a 0.1 (2.54) pitch and within ± 0.01 (0.25) of true position.

PIN CONNECTIONS

Single output variants

| 14 Pin DIP | |
|------------|----------|
| Pin | Function |
| 1 | -VIN |
| 7 | NC |
| 8 | +VOUT |
| 10 | -VOUT |
| 14 | +VIN |

| 7 Pin SIP | |
|-----------|----------|
| Pin | Function |
| 1 | +VIN |
| 2 | -VIN |
| 5 | -VOUT |
| 7 | +VOUT |

Dual output variants

| 14 Pin DIP | |
|------------|----------|
| Pin | Function |
| 1 | -VIN |
| 7 | NC |
| 8 | +VOUT |
| 9 | OV |
| 10 | -VOUT |
| 14 | +VIN |

| 7 Pin SIP | |
|-----------|----------|
| Pin | Function |
| 1 | +VIN |
| 2 | -VIN |
| 5 | -VOUT |
| 6 | OV |
| 7 | +VOUT |

PACKAGE SPECIFICATIONS (continued)

RECOMMENDED FOOTPRINT DETAILS

14 Pin DIP Package



7 Pin SIP Package



* Hole not required for single output variants.

TUBE OUTLINE DIMENSIONS

14 Pin DIP Tube

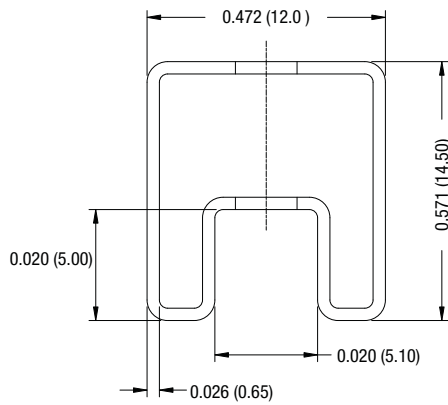

7 Pin SIP Tube



Unless otherwise stated all dimensions in inches (mm) ± 0.5 mm.
 Tube length (14 Pin DIP) : 20.47 (520mm ± 2 mm).
 Tube length (7 Pin SIP) : 20.47 (520mm ± 2 mm).

Tube Quantity : 25

Murata Power Solutions, Inc.
 11 Cabot Boulevard, Mansfield, MA 02048-1151 U.S.A.
 ISO 9001 and 14001 REGISTERED



**This product is subject to the following operating requirements and the Life and Safety Critical Application Sales Policy:
 Refer to: <http://www.murata-ps.com/requirements/>**

Murata Power Solutions, Inc. makes no representation that the use of its products in the circuits described herein, or the use of other technical information contained herein, will not infringe upon existing or future patent rights. The descriptions contained herein do not imply the granting of licenses to make, use, or sell equipment constructed in accordance therewith. Specifications are subject to change without notice.
 © 2012 Murata Power Solutions, Inc.



Компания «ЭлектроПласт» предлагает заключение долгосрочных отношений при поставках импортных электронных компонентов на взаимовыгодных условиях!

Наши преимущества:

- Оперативные поставки широкого спектра электронных компонентов отечественного и импортного производства напрямую от производителей и с крупнейших мировых складов;
- Поставка более 17-ти миллионов наименований электронных компонентов;
- Поставка сложных, дефицитных, либо снятых с производства позиций;
- Оперативные сроки поставки под заказ (от 5 рабочих дней);
- Экспресс доставка в любую точку России;
- Техническая поддержка проекта, помощь в подборе аналогов, поставка прототипов;
- Система менеджмента качества сертифицирована по Международному стандарту ISO 9001;
- Лицензия ФСБ на осуществление работ с использованием сведений, составляющих государственную тайну;
- Поставка специализированных компонентов (Xilinx, Altera, Analog Devices, Intersil, Interpoint, Microsemi, Aeroflex, Peregrine, Syfer, Eurofarad, Texas Instrument, Miteq, Cobham, E2V, MA-COM, Hittite, Mini-Circuits, General Dynamics и др.);

Помимо этого, одним из направлений компании «ЭлектроПласт» является направление «Источники питания». Мы предлагаем Вам помощь Конструкторского отдела:

- Подбор оптимального решения, техническое обоснование при выборе компонента;
- Подбор аналогов;
- Консультации по применению компонента;
- Поставка образцов и прототипов;
- Техническая поддержка проекта;
- Защита от снятия компонента с производства.



Как с нами связаться

Телефон: 8 (812) 309 58 32 (многоканальный)

Факс: 8 (812) 320-02-42

Электронная почта: org@eplast1.ru

Адрес: 198099, г. Санкт-Петербург, ул. Калинина, дом 2, корпус 4, литера А.