

## Fast Recovery Diodes (Stud Version), 6 A, 12 A



DO-203AA (DO-4)

### FEATURES

- Short reverse recovery time
- Low stored charge
- Wide current range
- Excellent surge capabilities
- Standard JEDEC® types
- Stud cathode and stud anode versions
- Fully characterized reverse recovery conditions
- Material categorization: for definitions of compliance please see [www.vishay.com/doc?99912](http://www.vishay.com/doc?99912)

**RoHS**  
COMPLIANT

### TYPICAL APPLICATIONS

- DC power supplies
- Inverters
- Converters
- Choppers
- Ultrasonic systems
- Freewheeling diodes

### PRODUCT SUMMARY

$I_{F(AV)}$	6 A, 12 A
Package	DO-203AA (DO-4)
Circuit configuration	Single diode

### MAJOR RATINGS AND CHARACTERISTICS

SYMBOL	TEST CONDITIONS	1N3879(R) TO 1N3883(R)	1N3889(R) TO 1N3893(R)	UNITS
$I_{F(AV)}$		6 <sup>(1)</sup>	12 <sup>(1)</sup>	A
	$T_C$ maximum	100	100	°C
$I_{F(RMS)}$		9.5	19	A
$I_{FSM}$	50 Hz	72	145	A
	60 Hz	75 <sup>(1)</sup>	150 <sup>(1)</sup>	
$I^2t$	50 Hz	26	103	A <sup>2</sup> s
	60 Hz	23	94	
$I^2\sqrt{t}$		363	856	$I^2\sqrt{s}$
$V_{RRM}$	Range	50 to 400 <sup>(1)</sup>	50 to 400 <sup>(1)</sup>	V
$t_{rr}$		See Recovery Characteristics table	See Recovery Characteristics table	ns
$T_J$	Range	-65 to +150	-65 to +150	°C

#### Note

<sup>(1)</sup> JEDEC® registered values



**ELECTRICAL SPECIFICATIONS**

VOLTAGE RATINGS						
TYPE NUMBER	VOLTAGE CODE	V <sub>RRM</sub> , MAXIMUM REPETITIVE PEAK AND OFF-STATE VOLTAGE V	V <sub>RSM</sub> , MAXIMUM NON-REPETITIVE PEAK VOLTAGE V	I <sub>RRM</sub> MAXIMUM AT T <sub>J</sub> = 25 °C µA	I <sub>RRM</sub> MAXIMUM AT T <sub>J</sub> = 100 °C mA	I <sub>RRM</sub> MAXIMUM AT T <sub>J</sub> = 150 °C mA
1N3879(R)	-	50	75	15 <sup>(1)</sup>	1.0 <sup>(1)</sup>	3.0 <sup>(1)</sup>
1N3880(R)		100	150			
1N3881(R)		200	250			
1N3882(R)		300	350			
1N3883(R)		400	450			
1N3889(R)	-	50	75	25 <sup>(1)</sup>	3.0 <sup>(1)</sup>	5.0 <sup>(1)</sup>
1N3890(R)		100	150			
1N3891(R)		200	250			
1N3892(R)		300	350			
1N3893(R)		400	450			

**Note**

(1) JEDEC® registered values

FORWARD CONDUCTION							
PARAMETER	SYMBOL	TEST CONDITIONS			1N3879(R) TO 1N3883(R)	1N3889(R) TO 1N3893(R)	UNITS
Maximum average forward current at case temperature	I <sub>F(AV)</sub>	180° conduction, half sine wave DC			6 <sup>(1)</sup>	12 <sup>(1)</sup>	A
					100	100	°C
Maximum RMS current	I <sub>F(RMS)</sub>				9.5	19	A
Maximum peak, one-cycle non-repetitive forward current	I <sub>FSM</sub>	t = 10 ms	No voltage reapplied	Sinusoidal half wave, initial T <sub>J</sub> = 150 °C	85	170	
		t = 8.3 ms			90	180	
		t = 10 ms	100 % V <sub>RRM</sub> reapplied		72	145	
		t = 8.3 ms			75 <sup>(1)</sup>	150 <sup>(1)</sup>	
Maximum I <sup>2</sup> t for fusing	I <sup>2</sup> t	t = 10 ms	No voltage reapplied		36	145	A <sup>2</sup> s
		t = 8.3 ms			33	130	
		t = 10 ms	100 % V <sub>RRM</sub> reapplied		26	103	
		t = 8.3 ms			23	94	
Maximum I <sup>2</sup> √t for fusing	I <sup>2</sup> √t	t = 0.1 ms to 10 ms, no voltage reapplied			363	1452	A <sup>2</sup> √s
Maximum forward voltage drop	V <sub>FM</sub>	T <sub>J</sub> = 25 °C; I <sub>F</sub> = Rated I <sub>F(AV)</sub> (DC)			1.4 <sup>(1)</sup>	1.4 <sup>(1)</sup>	V
		T <sub>C</sub> = 100 °C; I <sub>FM</sub> = π × rated I <sub>F(AV)</sub>			1.5 <sup>(1)</sup>	1.5 <sup>(1)</sup>	

**Note**

(1) JEDEC® registered values



RECOVERY CHARACTERISTICS					
PARAMETER	SYMBOL	TEST CONDITIONS	1N3879(R) TO 1N3883(R)	1N3889(R) TO 1N3893(R)	UNITS
Maximum reverse recovery time	$t_{rr}$	$T_J = 25\text{ }^\circ\text{C}$ , $I_F = 1\text{ A}$ to $V_R = 30\text{ V}$ , $di_F/dt = 100\text{ A}/\mu\text{s}$	150	150	ns
		$T_J = 25\text{ }^\circ\text{C}$ , $di_F/dt = 25\text{ A}/\mu\text{s}$ , $I_{FM} = \pi \times \text{rated } I_{F(AV)}$	300 <sup>(1)</sup>	300 <sup>(1)</sup>	
Maximum peak recovery current	$I_{RM(REC)}$	$I_{FM} = \pi \times \text{rated } I_{F(AV)}$	4 <sup>(1)</sup>	5 <sup>(1)</sup>	-
Maximum reverse recovery charge	$Q_{rr}$	$T_J = 25\text{ }^\circ\text{C}$ , $I_F = 1\text{ A}$ to $V_R = 30\text{ V}$ , $di_F/dt = 100\text{ A}/\mu\text{s}$	400	350	nC
		$T_J = 25\text{ }^\circ\text{C}$ , $di_F/dt = 25\text{ A}/\mu\text{s}$ , $I_{FM} = \pi \times \text{rated } I_{F(AV)}$	400	400	

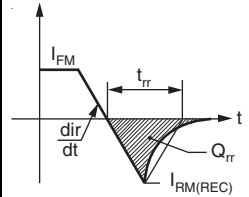

**Note**

<sup>(1)</sup> JEDEC® registered values

THERMAL AND MECHANICAL SPECIFICATIONS					
PARAMETER	SYMBOL	TEST CONDITIONS	1N3879(R) TO 1N3883(R)	1N3889(R) TO 1N3893(R)	UNITS
Maximum junction operating temperature range	$T_J$		-65 to +150		°C
Maximum storage temperature range	$T_{Stg}$		-65 to +175		
Maximum thermal resistance, junction to case	$R_{thJC}$	DC operation	2.5	2.0	°C/W
Maximum thermal resistance, case to heatsink	$R_{thCS}$	Mounting surface, smooth, flat and greased	0.5		
Allowable mounting torque		Not lubricated threads	1.5 +0 - 10 % (13)		N · m (lbf · in)
		Lubricated threads	1.2 +0 - 10 % (10)		
Approximate weight			7		g
			0.25		oz.
Case style		JEDEC®	DO-203AA (DO-4)		

$\Delta R_{thJC}$ CONDUCTION						
CONDUCTION ANGLE	1N3879(R) TO 1N3883(R)	1N3889(R) TO 1N3893(R)	1N3879(R) TO 1N3883(R)	1N3889(R) TO 1N3893(R)	TEST CONDITIONS	UNITS
	SINUSOIDAL CONDUCTION		RECTANGULAR CONDUCTION			
180°	0.58	0.46	0.33	0.26	$T_J = 150\text{ }^\circ\text{C}$	K/W
120°	0.60	0.48	0.58	0.46		
60°	1.28	1.02	1.28	1.02		
30°	2.20	1.76	2.20	1.76		

**Note**

• The table above shows the increment of thermal resistance  $R_{thJC}$  when devices operate at different conduction angles than DC

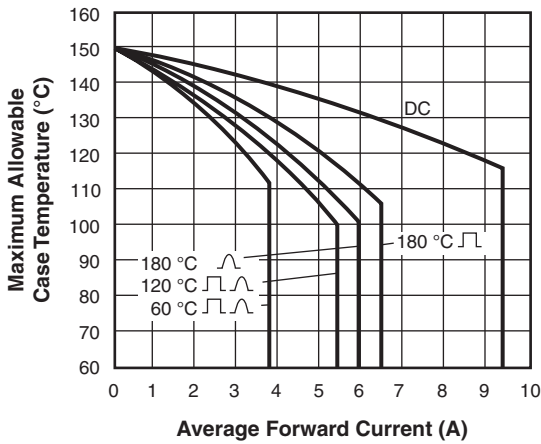

Fig. 1 - Average Forward Current vs. Maximum Allowable Case Temperature, 1N3879 Series

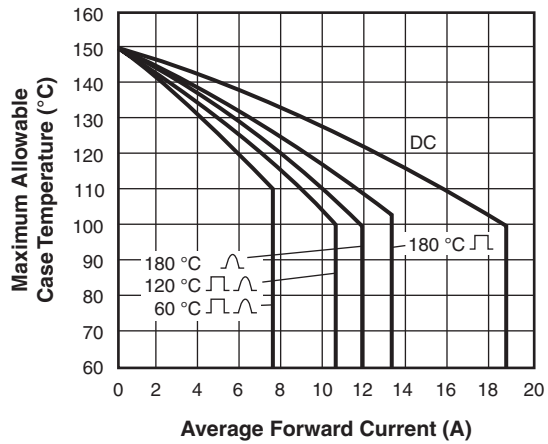
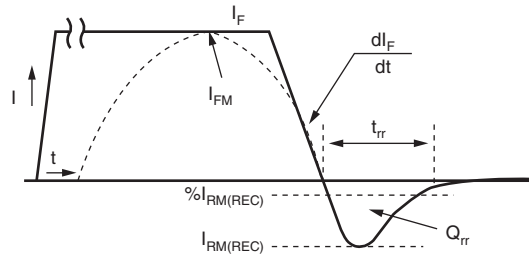

Fig. 2 - Average Forward Current vs. Maximum Allowable Case Temperature, 1N3889 Series



$I_F, I_{FM}$  - Peak forward current prior to commutation  
 $-di_F/dt$  - Rate of fall of forward current  
 $I_{RM(REC)}$  - Peak reverse recovery current  
 $t_{rr}$  - Reverse recovery time  
 $Q_{rr}$  - Reverse recovered charge

Fig. 3 - Reverse Recovery Time Test Waveform

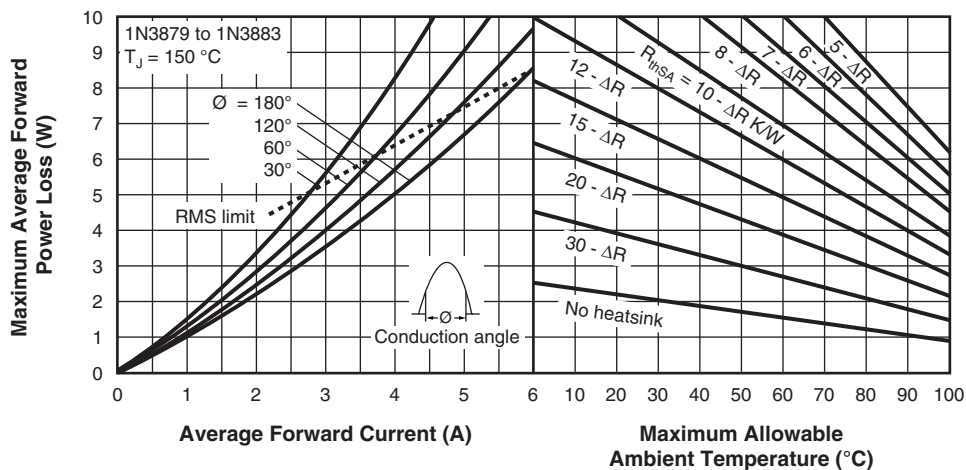
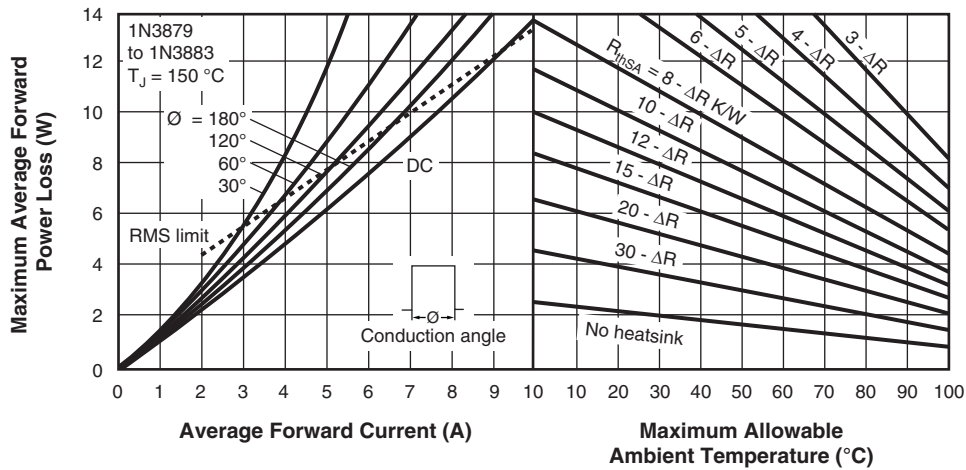
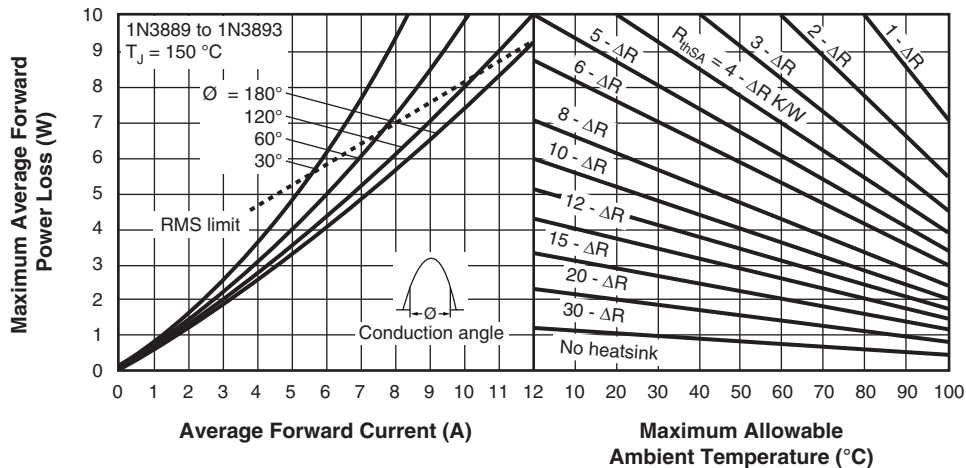

Fig. 4 - Current Rating Nomogram (Sinusoidal Waveforms), 1N3879 Series



Conduction angle - $\phi$	$\Delta R$ - KW
DC	0
180°	0.33
120°	0.58
60°	1.28
30°	2.20

Fig. 5 - Current Rating Nomogram (Rectangular Waveforms), 1N3879 Series



Conduction angle - $\phi$	$\Delta R$ - KW
180°	0.46
120°	0.48
60°	1.02
30°	1.76

Fig. 6 - Current Rating Nomogram (Sinusoidal Waveforms), 1N3889 Series

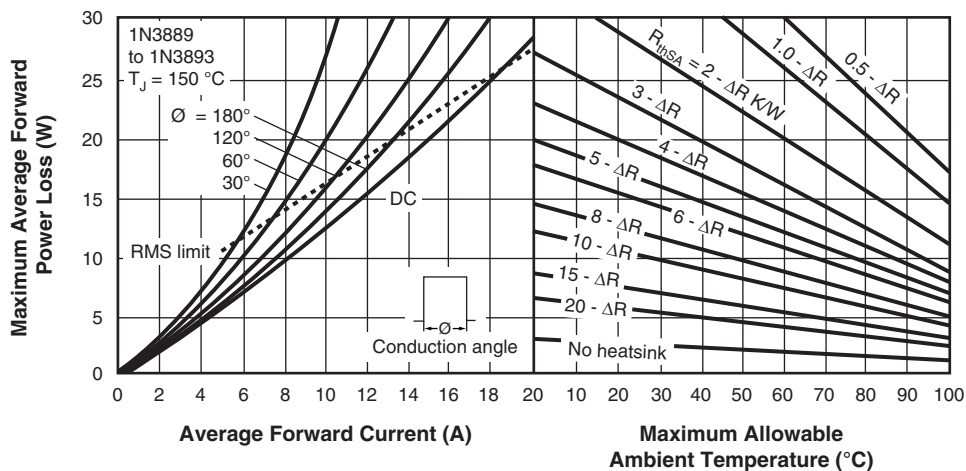

Conduction angle - $\phi$	$\Delta R$ - KW
DC	0
180°	0.26
120°	0.46
60°	1.02
30°	1.76

Fig. 7 - Current Rating Nomogram (Rectangular Waveforms), 1N3889 Series

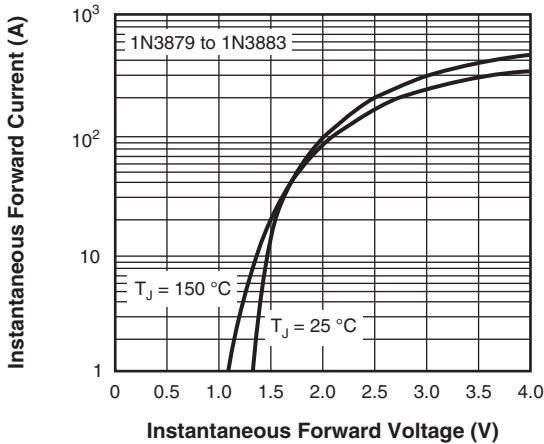

Fig. 8 - Maximum Forward Voltage vs. Forward Current, 1N3879 Series

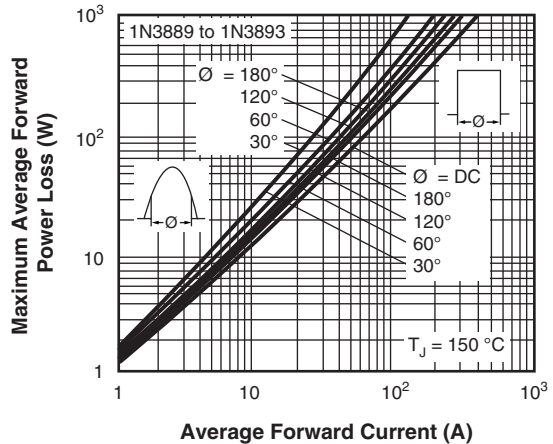

Fig. 11 - Maximum High Level Forward Power Loss vs. Average Forward Current, 1N3889 Series

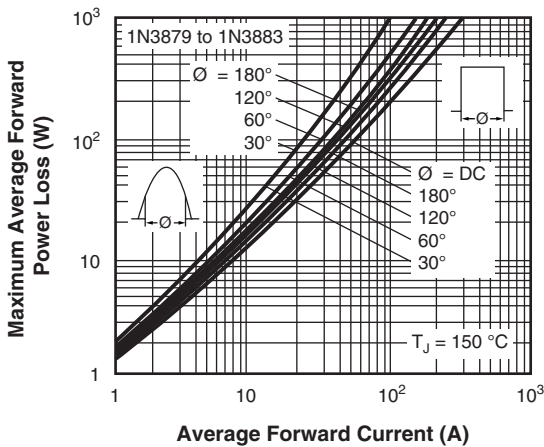

Fig. 9 - Maximum High Level Forward Power Loss vs. Average Forward Current, 1N3879 Series

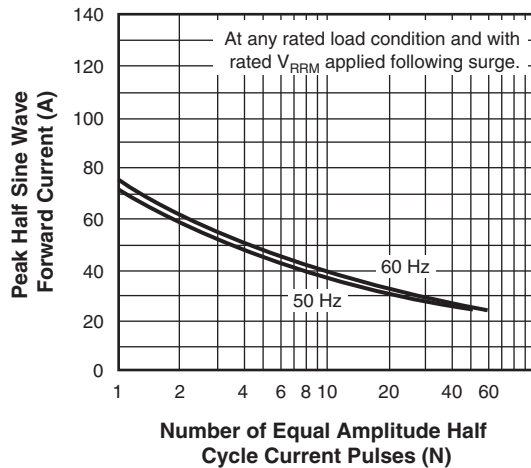

Fig. 12 - Maximum Non-Repetitive Surge Current vs. Number of Current Pulses, 1N3879 Series

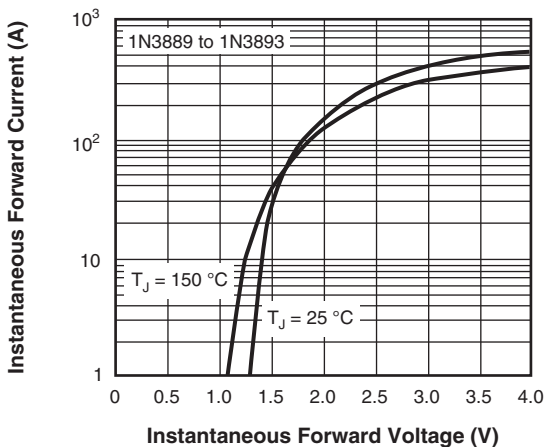

Fig. 10 - Maximum Forward Voltage vs. Forward Current, 1N3889 Series

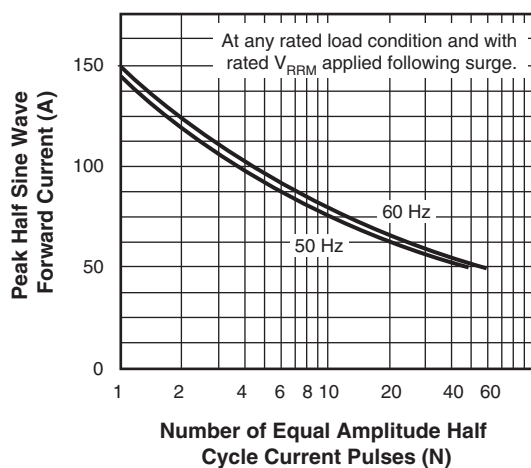

Fig. 13 - Maximum Non-Repetitive Surge Current vs. Number of Current Pulses, 1N3889 Series

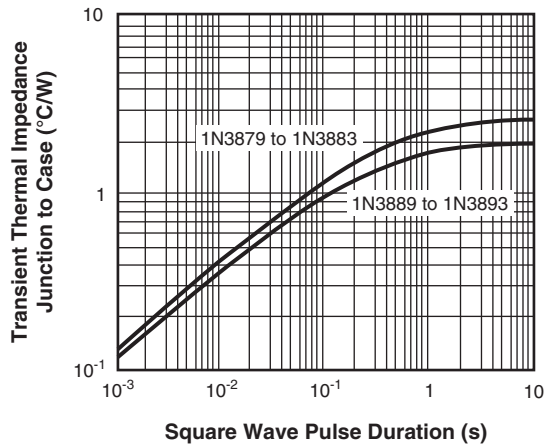
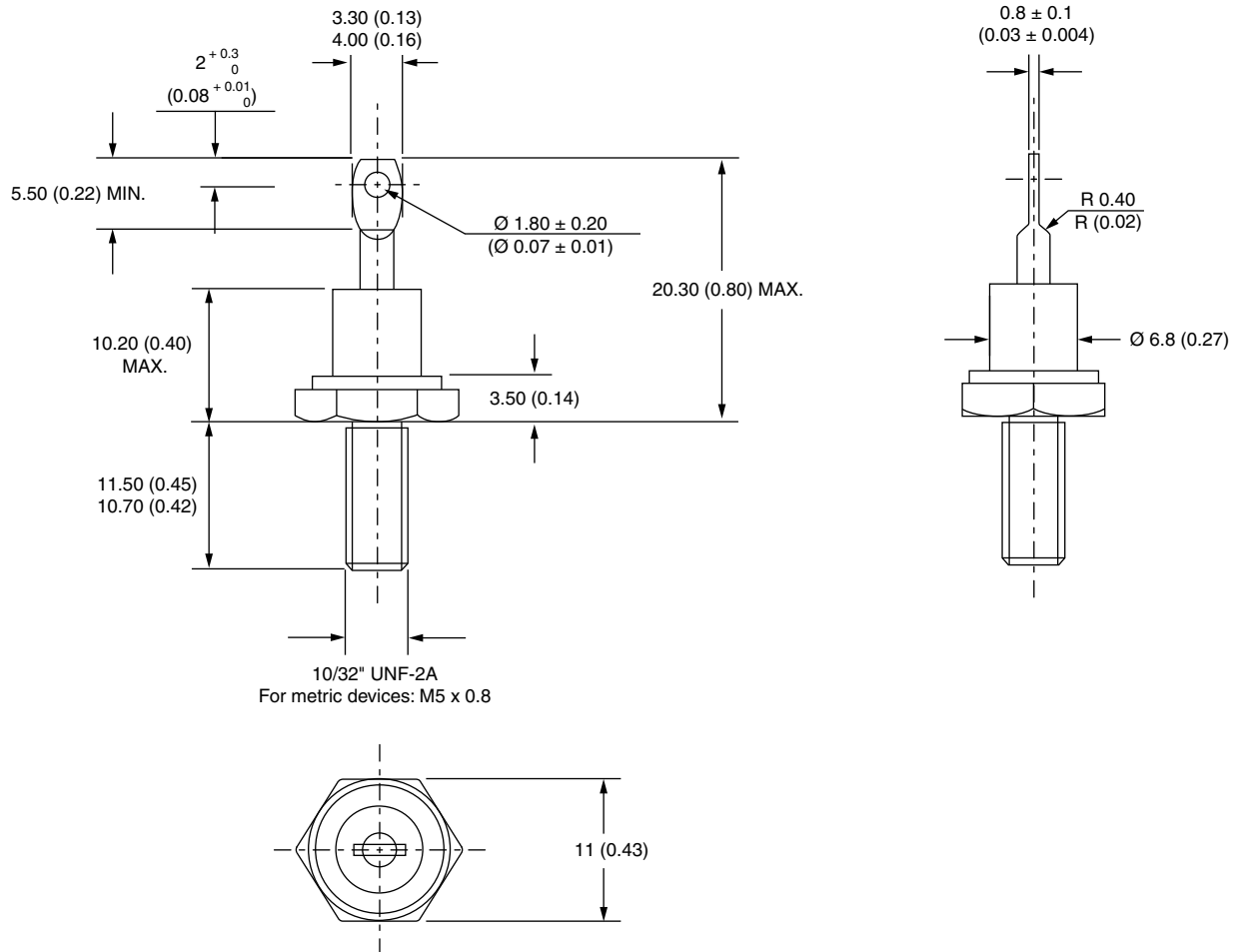

Fig. 14 - Maximum Transient Thermal Impedance, Junction to Case vs. Pulse Duration, All Series

LINKS TO RELATED DOCUMENTS	
Dimensions	<a href="http://www.vishay.com/doc?95311">www.vishay.com/doc?95311</a>

## DO-203AA (DO-4)

**DIMENSIONS** in millimeters (inches)







## Disclaimer

ALL PRODUCT, PRODUCT SPECIFICATIONS AND DATA ARE SUBJECT TO CHANGE WITHOUT NOTICE TO IMPROVE RELIABILITY, FUNCTION OR DESIGN OR OTHERWISE.

Vishay Intertechnology, Inc., its affiliates, agents, and employees, and all persons acting on its or their behalf (collectively, "Vishay"), disclaim any and all liability for any errors, inaccuracies or incompleteness contained in any datasheet or in any other disclosure relating to any product.

Vishay makes no warranty, representation or guarantee regarding the suitability of the products for any particular purpose or the continuing production of any product. To the maximum extent permitted by applicable law, Vishay disclaims (i) any and all liability arising out of the application or use of any product, (ii) any and all liability, including without limitation special, consequential or incidental damages, and (iii) any and all implied warranties, including warranties of fitness for particular purpose, non-infringement and merchantability.

Statements regarding the suitability of products for certain types of applications are based on Vishay's knowledge of typical requirements that are often placed on Vishay products in generic applications. Such statements are not binding statements about the suitability of products for a particular application. It is the customer's responsibility to validate that a particular product with the properties described in the product specification is suitable for use in a particular application. Parameters provided in datasheets and/or specifications may vary in different applications and performance may vary over time. All operating parameters, including typical parameters, must be validated for each customer application by the customer's technical experts. Product specifications do not expand or otherwise modify Vishay's terms and conditions of purchase, including but not limited to the warranty expressed therein.

Except as expressly indicated in writing, Vishay products are not designed for use in medical, life-saving, or life-sustaining applications or for any other application in which the failure of the Vishay product could result in personal injury or death. Customers using or selling Vishay products not expressly indicated for use in such applications do so at their own risk. Please contact authorized Vishay personnel to obtain written terms and conditions regarding products designed for such applications.

No license, express or implied, by estoppel or otherwise, to any intellectual property rights is granted by this document or by any conduct of Vishay. Product names and markings noted herein may be trademarks of their respective owners.

## Material Category Policy

**Vishay Intertechnology, Inc. hereby certifies that all its products that are identified as RoHS-Compliant fulfill the definitions and restrictions defined under Directive 2011/65/EU of The European Parliament and of the Council of June 8, 2011 on the restriction of the use of certain hazardous substances in electrical and electronic equipment (EEE) - recast, unless otherwise specified as non-compliant.**

**Please note that some Vishay documentation may still make reference to RoHS Directive 2002/95/EC. We confirm that all the products identified as being compliant to Directive 2002/95/EC conform to Directive 2011/65/EU.**

**Vishay Intertechnology, Inc. hereby certifies that all its products that are identified as Halogen-Free follow Halogen-Free requirements as per JEDEC JS709A standards. Please note that some Vishay documentation may still make reference to the IEC 61249-2-21 definition. We confirm that all the products identified as being compliant to IEC 61249-2-21 conform to JEDEC JS709A standards.**



Компания «ЭлектроПласт» предлагает заключение долгосрочных отношений при поставках импортных электронных компонентов на взаимовыгодных условиях!

Наши преимущества:

- Оперативные поставки широкого спектра электронных компонентов отечественного и импортного производства напрямую от производителей и с крупнейших мировых складов;
- Поставка более 17-ти миллионов наименований электронных компонентов;
- Поставка сложных, дефицитных, либо снятых с производства позиций;
- Оперативные сроки поставки под заказ (от 5 рабочих дней);
- Экспресс доставка в любую точку России;
- Техническая поддержка проекта, помощь в подборе аналогов, поставка прототипов;
- Система менеджмента качества сертифицирована по Международному стандарту ISO 9001;
- Лицензия ФСБ на осуществление работ с использованием сведений, составляющих государственную тайну;
- Поставка специализированных компонентов (Xilinx, Altera, Analog Devices, Intersil, Interpoint, Microsemi, Aeroflex, Peregrine, Syfer, Eurofarad, Texas Instrument, Miteq, Cobham, E2V, MA-COM, Hittite, Mini-Circuits, General Dynamics и др.);

Помимо этого, одним из направлений компании «ЭлектроПласт» является направление «Источники питания». Мы предлагаем Вам помощь Конструкторского отдела:

- Подбор оптимального решения, техническое обоснование при выборе компонента;
- Подбор аналогов;
- Консультации по применению компонента;
- Поставка образцов и прототипов;
- Техническая поддержка проекта;
- Защита от снятия компонента с производства.



#### Как с нами связаться

**Телефон:** 8 (812) 309 58 32 (многоканальный)

**Факс:** 8 (812) 320-02-42

**Электронная почта:** [org@eplast1.ru](mailto:org@eplast1.ru)

**Адрес:** 198099, г. Санкт-Петербург, ул. Калинина, дом 2, корпус 4, литера А.