

LOC	DIST	REVISIONS					
		P	LTN	DESCRIPTION	DATE	DWN	APVD
GP	00	G		REV PER ECO-15-000526	19JAN2015	LAW	CZ

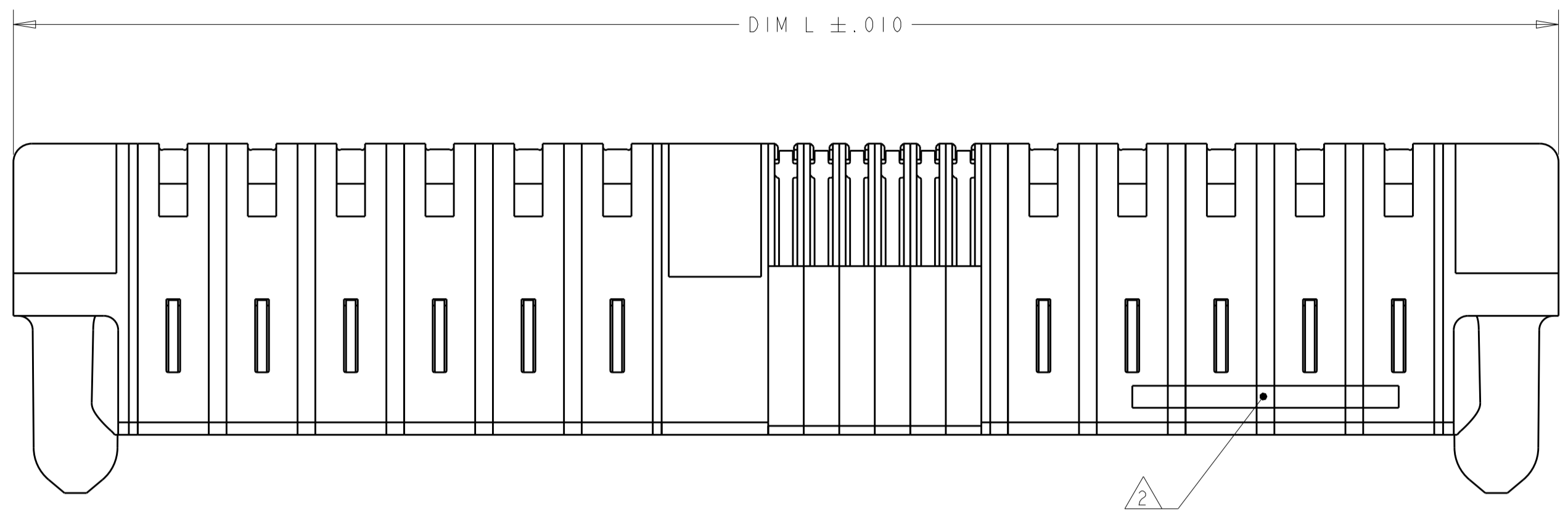

- 1 OPTIONAL CENTER MODULE, WITH $\varnothing .150$ THRU HOLE OR HOLD DOWN FEATURE.
- 2 "AMP", PART NUMBER, AND DATE CODE TO BE MARKED IN AREA SHOWN.
- 3 MATERIAL: HOUSING - GLASS FILLED HIGH TEMP THERMO PLASTIC, BLACK, UL94 V-0
SIGNAL CONTACT - HIGH CONDUCTIVITY COPPER ALLOY
POWER CONTACT - HIGH CONDUCTIVITY COPPER ALLOY
- 4 CONTACT PLATING: NOBLE PLATING ON CONTACT FUNCTIONAL AREA OF POWER AND SIGNAL CONTACTS
- 5 MECHANICAL CONNECTOR KEEP OUT ZONE.
- 6 DATUM AND BASIC DIMENSIONS ESTABLISHED BY CUSTOMER.
- 7 PCB- ALL HOLE DIAMETERS ARE FINISHED DIMENSIONS.
- 8 PCB- $\varnothing .0453 \pm .0010$ DRILLED HOLES PLATED WITH $.0003$ MIN Sn OVER $.001-.003$ CU PLATING TO ACHIEVE A $\varnothing .040 \pm .003$ HOLE.

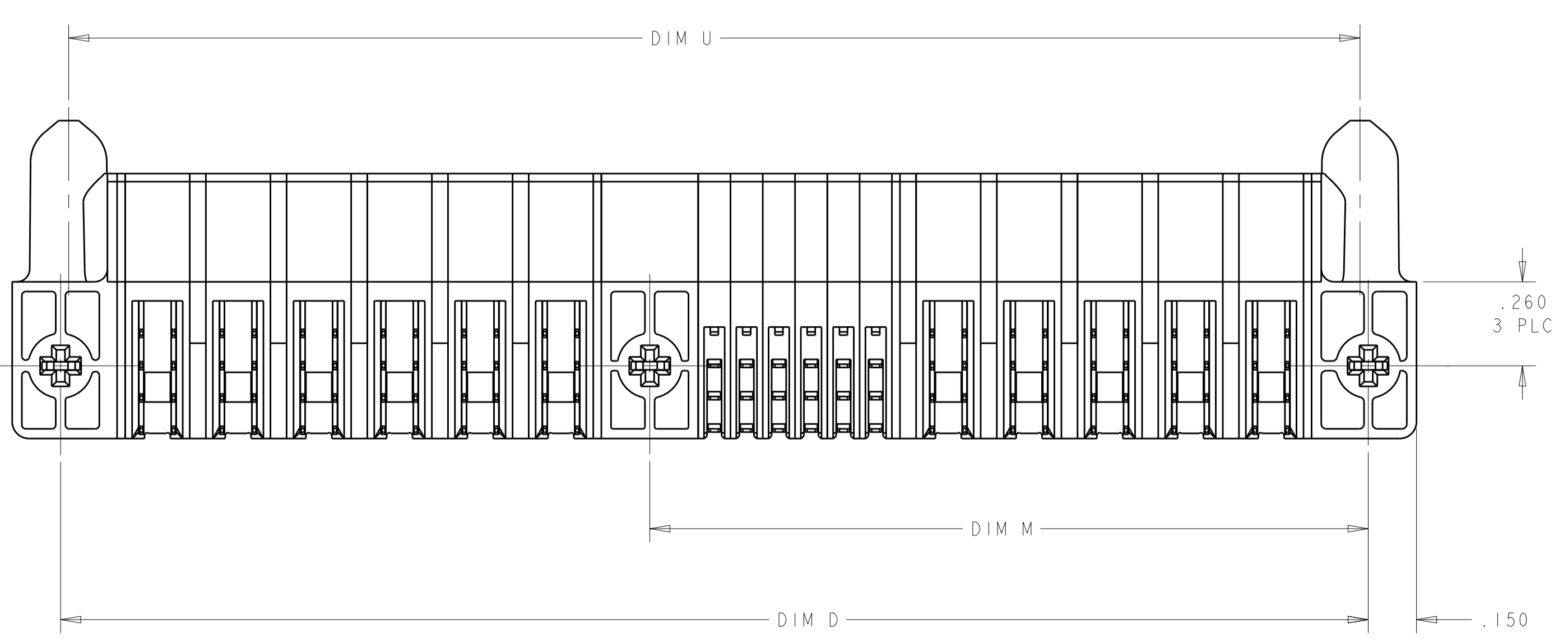
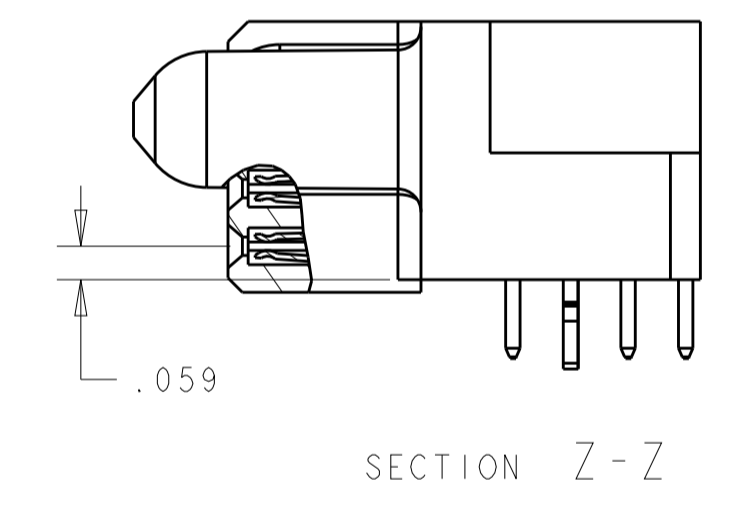
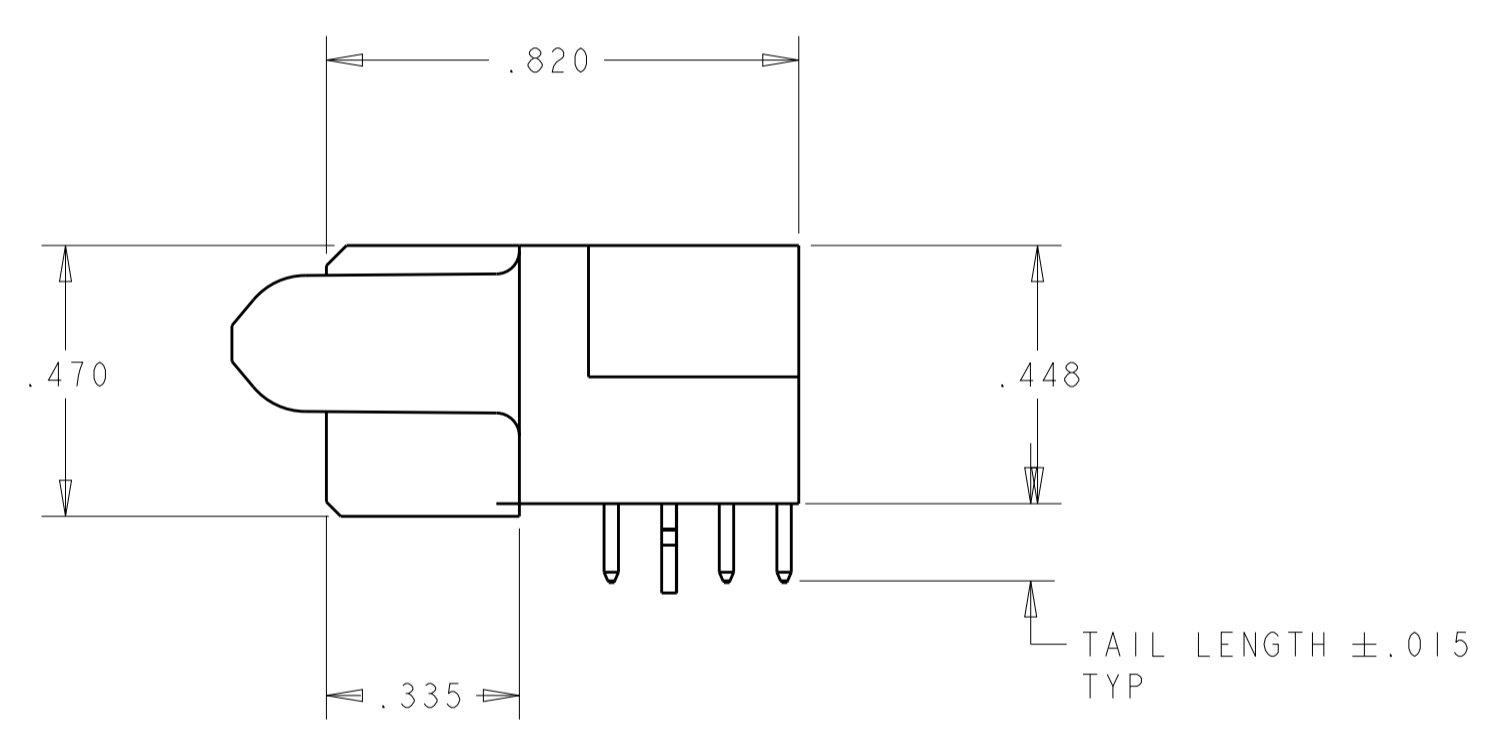
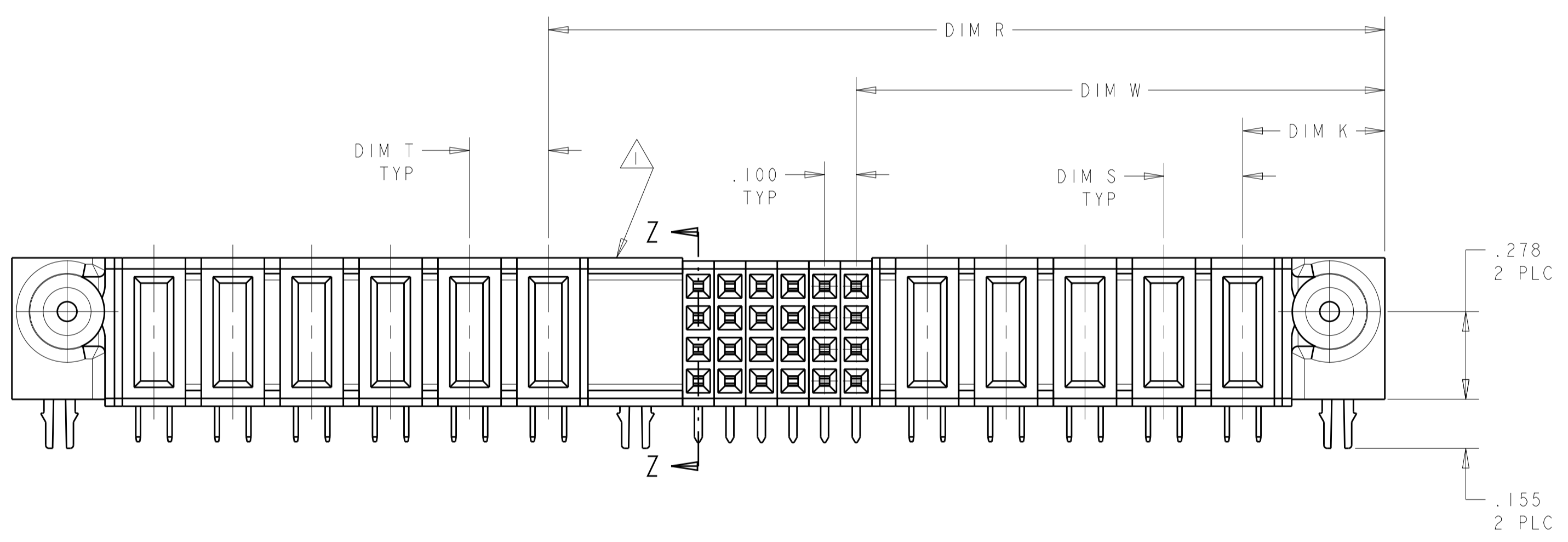

THIS DRAWING IS A CONTROLLED DOCUMENT.		OWN R. GRZYBOWSKI	Z1FEB05	STE TE Connectivity											
DIMENSIONS: INCHES		CHK M. PERCHERKE	Z1FEB05												
TOLERANCES UNLESS OTHERWISE SPECIFIED:		APVD M. PERCHERKE	Z1FEB05												
<table border="0"> <tr><td>0 PLC</td><td>±</td></tr> <tr><td>1 PLC</td><td>±.01</td></tr> <tr><td>2 PLC</td><td>±.01</td></tr> <tr><td>3 PLC</td><td>±.005</td></tr> <tr><td>4 PLC</td><td>±.002</td></tr> <tr><td>ANGLES</td><td>±.2°</td></tr> </table>		0 PLC	±		1 PLC	±.01	2 PLC	±.01	3 PLC	±.005	4 PLC	±.002	ANGLES	±.2°	PRODUCT SPEC
0 PLC	±														
1 PLC	±.01														
2 PLC	±.01														
3 PLC	±.005														
4 PLC	±.002														
ANGLES	±.2°														
MATERIAL	FINISH	APPLICATION SPEC	RESTRICTED TO												
		108-1973	SIZE CAGE CODE DRAWING NO												
		114-13038	A100779C=6450160												
		WEIGHT	SCALE 3:1 SHEET 1 OF 16 REV G1												
		Customer Drawing													

THIS DRAWING IS UNPUBLISHED. RELEASED FOR PUBLICATION 20
COPYRIGHT 20 BY - ALL RIGHTS RESERVED.

LOC	DIST	REVISIONS					
		P	LTN	DESCRIPTION	DATE	DWN	APVD
GP	00	-	-	SEE SHEET 1	-	-	-

.700	-	-	-	.375	.750	-	1.050	-	16S	4-6450160-9
2.700	-	.200	2.600	1.425	2.750	-	3.050	.450	5P + 44S + 1P	4-6450160-8
4.000	-	-	-	.375	4.050	-	4.350	-	148S	4-6450160-6
2.000	.250	.250	1.650	.925	2.050	-	2.350	.450	2P + 24S + 2P	4-6450160-5
2.800	-	-	-	0.375	2.850	-	3.150	-	100S	4-6450160-4
1.100	-	-	1.000	.625	1.150	-	1.450	.450	1P + 12S + 1P	4-6450160-1
2.400	.250	.250	1.550	.875	2.450	-	2.750	.450	2P + 24S + 4P	4-6450160-0
4.700	.250	.250	2.850	2.375	4.750	-	5.050	.450	8P + 16S + 8P	3-6450160-9
5.400	.300	.300	2.875	2.175	5.450	-	5.750	.475	6P + 24S + 9P	3-6450160-8
2.900	.250	.250	2.050	1.375	2.950	-	3.250	.450	4P + 24S + 4P	3-6450160-7
3.900	.250	.250	2.550	1.875	3.950	-	4.250	.450	6P + 24S + 6P	3-6450160-6
3.800	.250	.250	3.450	.875	3.850	-	4.150	.450	2P + 100S + 2P	3-6450160-4
3.700	.300	.200	2.700	2.025	3.750	-	4.050	.450	8P+24S+4ACP	3-6450160-3
2.800	.300	.250	2.075	1.375	2.850	-	3.150	.450	4P + 24S + 3ACP	3-6450160-2
1.700	.250	.250	1.350	.875	1.750	-	2.050	.450	2P + 16S + 2P	3-6450160-1
4.375	.300	.250	3.375	2.375	4.450	2.950	4.725	.450	8P+24S+1M+4ACP	3-6450160-0
4.100	.250	.300	2.250	1.575	4.150	-	4.450	.475	4ACP + 24S + 8P	2-6450160-9
2.000	.250	.300	1.650	1.325	2.050	-	2.350	.475	3ACP + 8S + 2P	2-6450160-7
2.600	.200	.200	1.900	1.225	2.650	-	2.950	.450	4HDP + 24S + 4HDP	2-6450160-6
2.000	.250	.250	1.650	.925	2.050	-	2.350	.450	2P + 24S + 2P	2-6450160-5
4.000	.250	.250	2.650	1.675	4.050	2.225	4.350	.450	5P + 24S + 1M + 6P	2-6450160-0
3.300	.250	.250	2.450	1.875	3.350	-	3.650	.450	6P + 20S + 4P	1-6450160-9
4.675	.300	.250	3.950	3.375	4.725	-	5.025	.450	12P + 20S + 3ACP	1-6450160-8
3.250	.250	.250	2.900	1.125	3.300	-	3.600	.450	3P + 68S + 2P	1-6450160-3
.900	-	-	-	.375	.950	-	1.250	-	0P + 24S + 0P	1-6450160-2
1.900	-	-	.975	.625	1.950	-	2.250	.450	1P + 12S + 5P	1-6450160-1
1.900	.250	.250	1.550	.875	1.950	-	2.250	.450	2P + 24S + 2P	1-6450160-0
3.300	.250	.250	2.450	1.875	3.350	-	3.650	.450	6P + 20S + 4P	6450160-9
2.400	.250	.250	1.800	1.125	2.450	-	2.750	.450	3P + 24S + 3P	6450160-8
3.050	.250	.300	1.950	1.275	3.100	-	3.400	.475	3ACP + 24S + 5P	6450160-7
7.400	.250	.250	5.050	2.875	7.450	-	7.750	.450	10P + 84S + 10P	6450160-6
4.000	.250	.250	2.650	1.675	4.050	2.225	4.350	.450	5P + 24S + 1M + 6P	6450160-5
4.000	.250	.250	2.650	1.675	4.050	2.225	4.350	.450	5P + 24S + 1M + 6P	6450160-4
1.575	-	-	1.425	.700	1.625	-	1.925	.475	1P + 24S + 1P	6450160-3
1.575	-	-	1.425	.700	1.625	-	1.925	.475	1P + 24S + 1P	6450160-2
5.100	.250	.250	3.250	2.375	5.150	-	5.450	.450	8P + 32S + 8P	6450160-1
U	T	S	R	W	D	M	L	K	DESCRIPTION	PART NUMBER

(E6) PART IS IN SHEET 15

THIS DRAWING IS A CONTROLLED DOCUMENT.

DIMENSIONS: INCHES	TOLERANCES UNLESS OTHERWISE SPECIFIED: 0 PLC ±. 1 PLC ±.01 3 PLC ±.005 4 PLC ±.002 ANGLES ±.02	DWN R. GRZYBOWSKI CHK M. PERCHERKE APVD M. PERCHERKE	ZIFB05 ZIFB05 ZIFB05	NAME RIGHT ANGLE RECEPTACLE ASSEMBLY WITH GUIDES MULTI-BEAM XL
MATERIAL	FINISH	PRODUCT SPEC 108-1973	APPLICATION SPEC 114-13038	RESTRICTED TO
Customer Drawing		SIZE A100779	DRAWING NO C=6450160	SCALE 3:1

TE Connectivity

Customer Drawing

SCALE 3:1 SHEET 2 OF 16 REV G

LOC	DIST	REV	DATE	BY	APPV
GP	00				

PART NUMBER	ROWS	POWER							SIGNAL							POWER													
		P16	P15	P14	P13	P12	P11	P10	P9	8	7	6	5	4	3	2	1	P8	P7	P6	P5	P4	P3	P2	P1				
6450160-1	D C B A	RA	RA	RA	RA	RA	RA	RA	H	H	H	H	H	H	H	H	RA	RA	RA	RA	RA	RA	RA	RA					
		9' + 36S + 8P																											

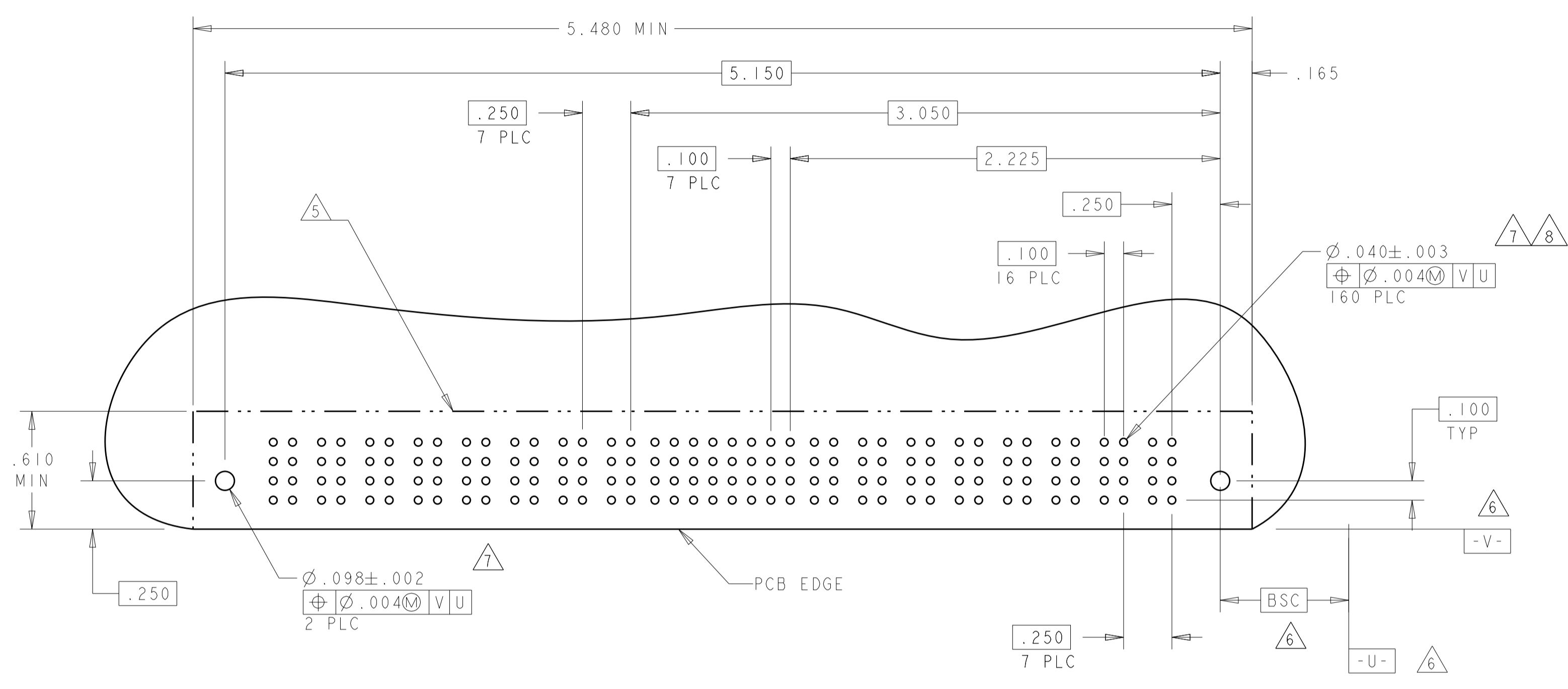

PART NUMBER	ROWS	POWER					SIGNAL					POWER								
		P11	P10	P9	P8	P7	M1	6	5	4	3	2	1	P5	P4	P3	P2	P1		
6450160-4	D C B A	RB	RB	RB	RB	RB	L	L	L	L	L	L	L	L	L	RB	RB	RB	RB	RB
		5P + 24S + 1M + 6P																		

PART NUMBER	ROWS	POWER					SIGNAL					POWER							
		P11	P10	P9	P8	P7	M1	6	5	4	3	2	1	P5	P4	P3	P2	P1	
6450160-5	D C B A	RA	RA	RA	RA	RA	H	H	H	H	H	H	H	H	RA	RA	RA	RA	RA
		5P + 24S + 1M + 6P																	

PART NUMBER	ROWS	POWER					SIGNAL					POWER										
		P2	6	5	4	3	2	1	P1													
6450160-2	D C B A	RB	K	K	K	K	K	K	J	J	J	J	J	J	J	RB						
		1P + 24S + 1P																				

PART NUMBER	ROWS	POWER					SIGNAL					POWER										
		P2	6	5	4	3	2	1	P1													
6450160-3	D C B A	RA	H	H	H	H	H	H	G	G	G	G	G	G	G	RA						
		1P + 24S + 1P																				

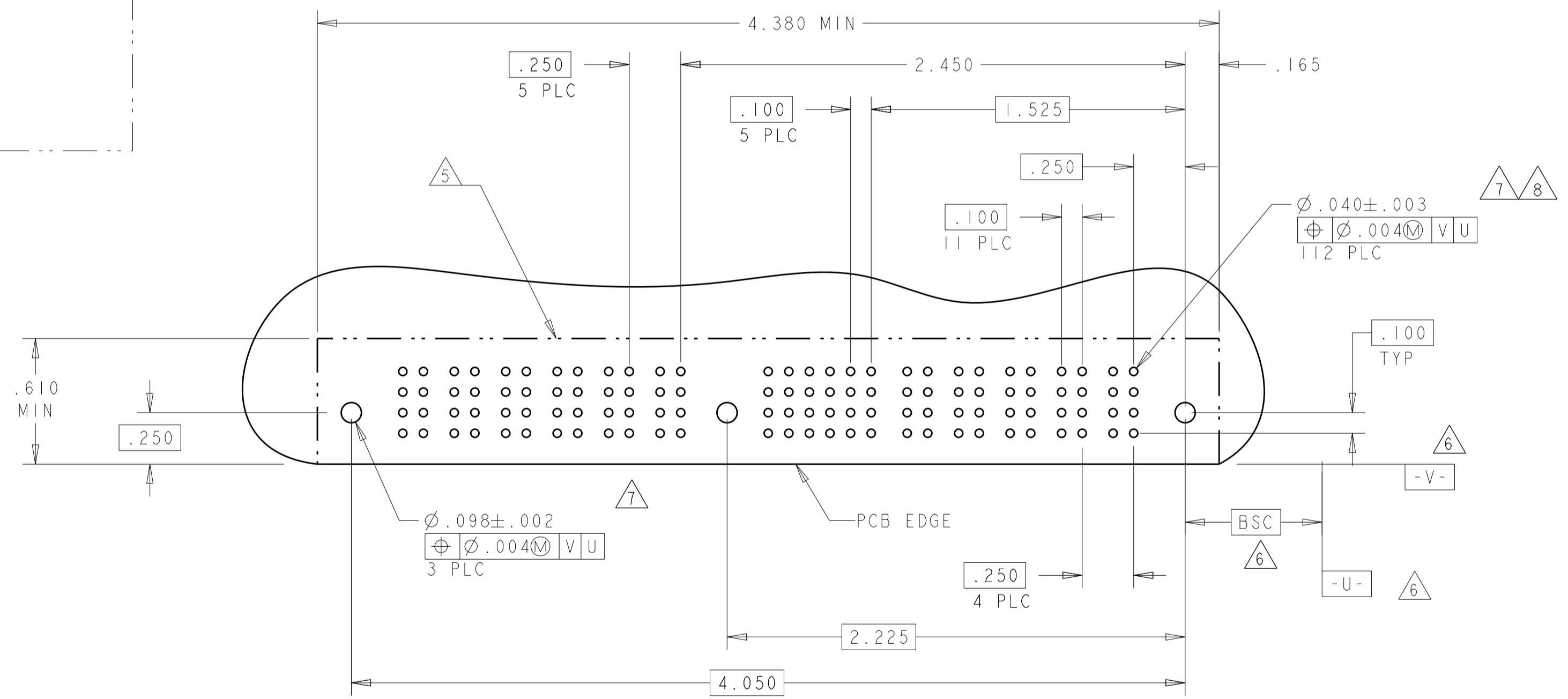
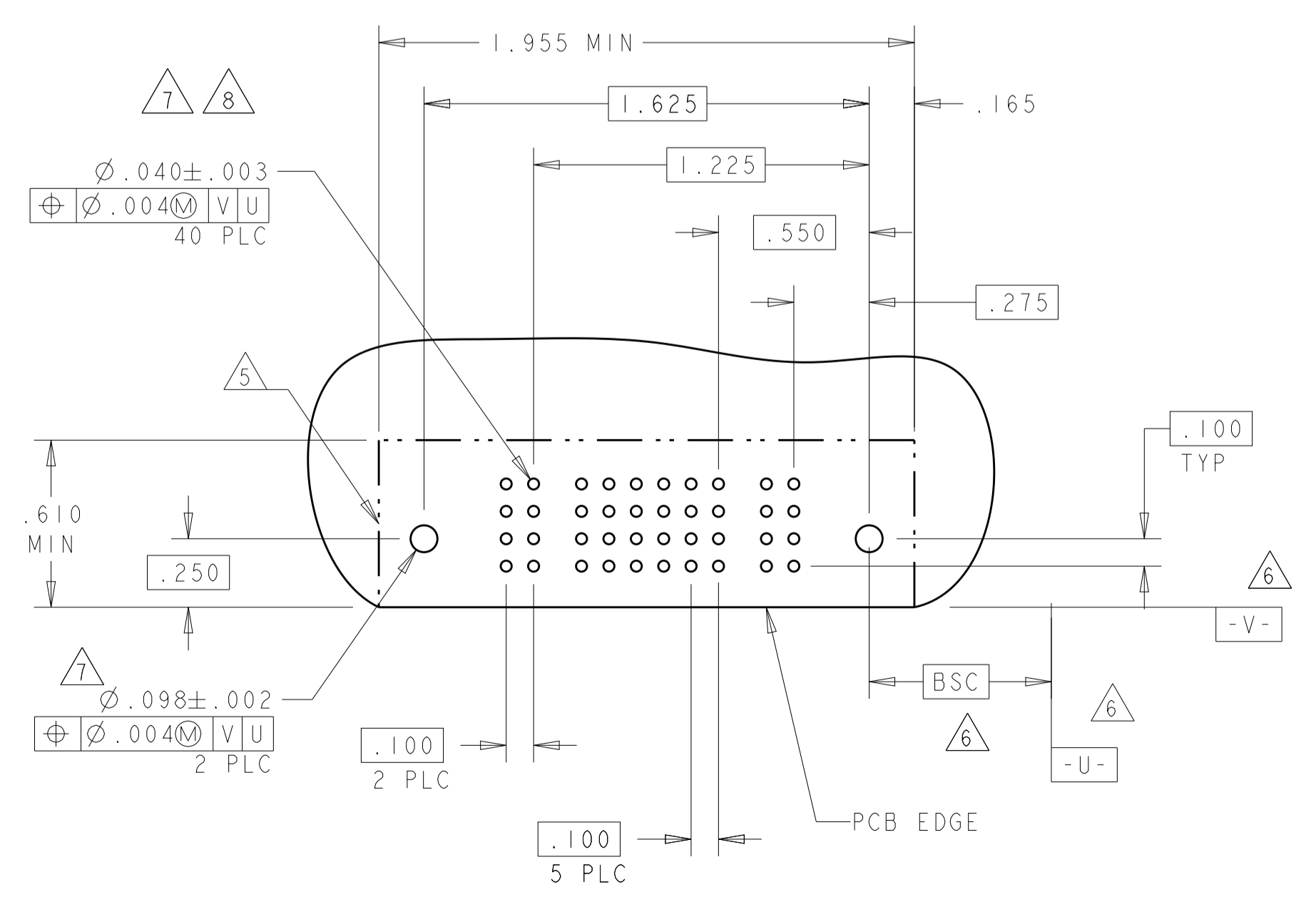

CODE	TAIL LENGTH	DESCRIPTION
RN	.090	STD
RM	.135	STD
RA	.135	MFBL
RB	.090	MFBL

POWER CONTACT

CODE	TAIL LENGTH	ROW
L	.090	D
K	.090	C
J	.090	B
I	.090	A
H	.135	D
G	.135	C
F	.135	B
E	.135	A

SIGNAL CONTACT

THIS DRAWING IS A CONTROLLED DOCUMENT.

OWN: R. GRZYBOWSKI 21FEB05
 CHK: M. PERCHERKE 21FEB05
 APV: M. PERCHERKE 21FEB05

PRODUCT SPEC: 108-1973
 APPLICATION SPEC: 114-13038
 WEIGHT: -
 Customer Drawing

STE TE Connectivity

NAME: RIGHT ANGLE RECEPTACLE ASSEMBLY WITH GUIDES MULTI-BEAM XL

SIZE: A100779 C=6450160
 SHEET 3 OF 16

SCALE: 4:1

PART NUMBER	ROWS	POWER		SIGNAL				POWER		
		P4	P3	6	5	4	3	2	1	P2
I-6450160-0	D C B A	RA	RA	H	H	H	H	H	RA	RA
				G	G	G	G	G		
				F	F	F	F	F		
2P + 24S + 2P										

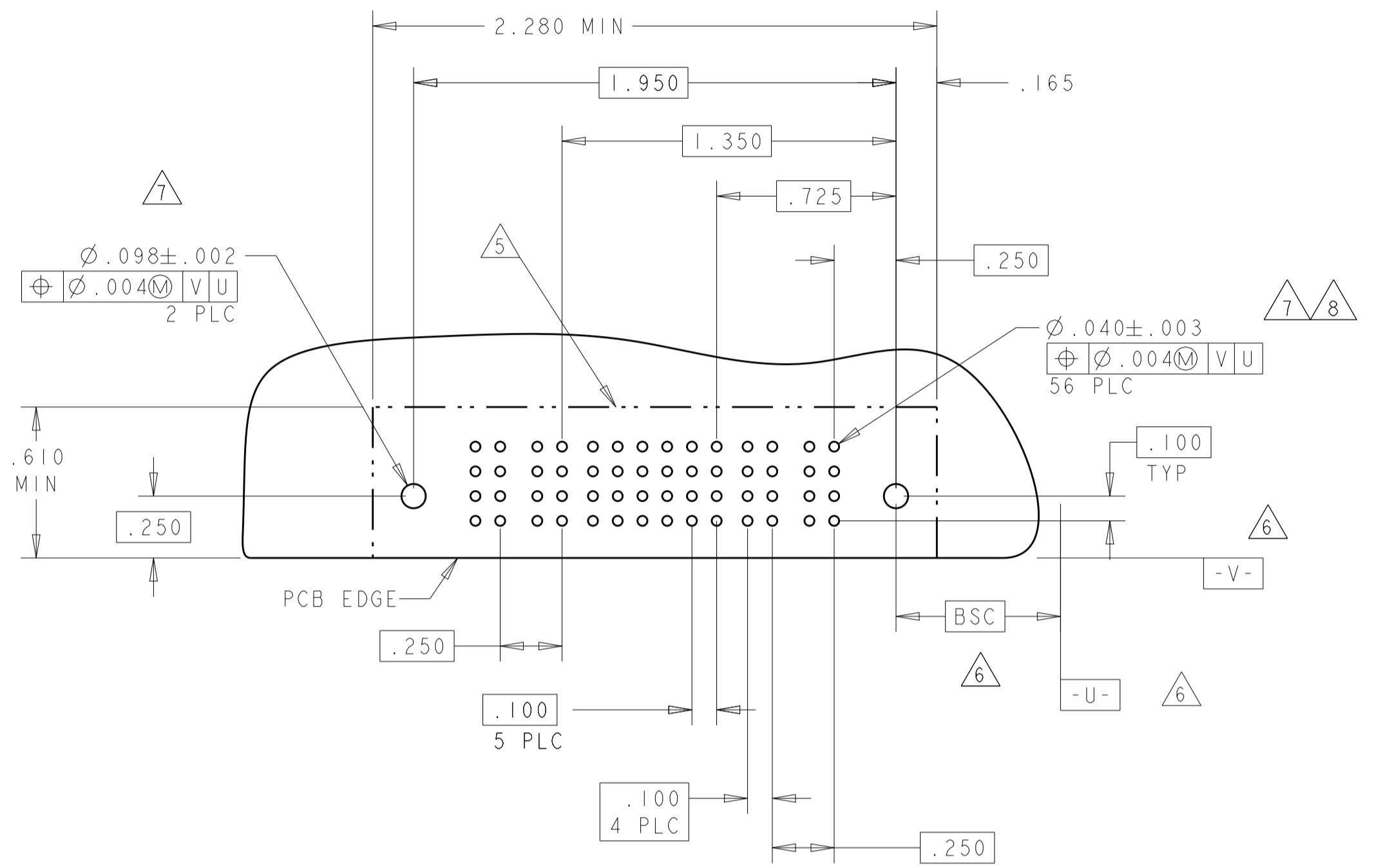

PART NUMBER	ROWS	SIGNAL					
		6	5	4	3	2	1
I-6450160-2	D C B A	L	L	L	L	L	L
		K	K	K	K	K	K
		J	J	J	J	J	J
0P + 24S + 0P							

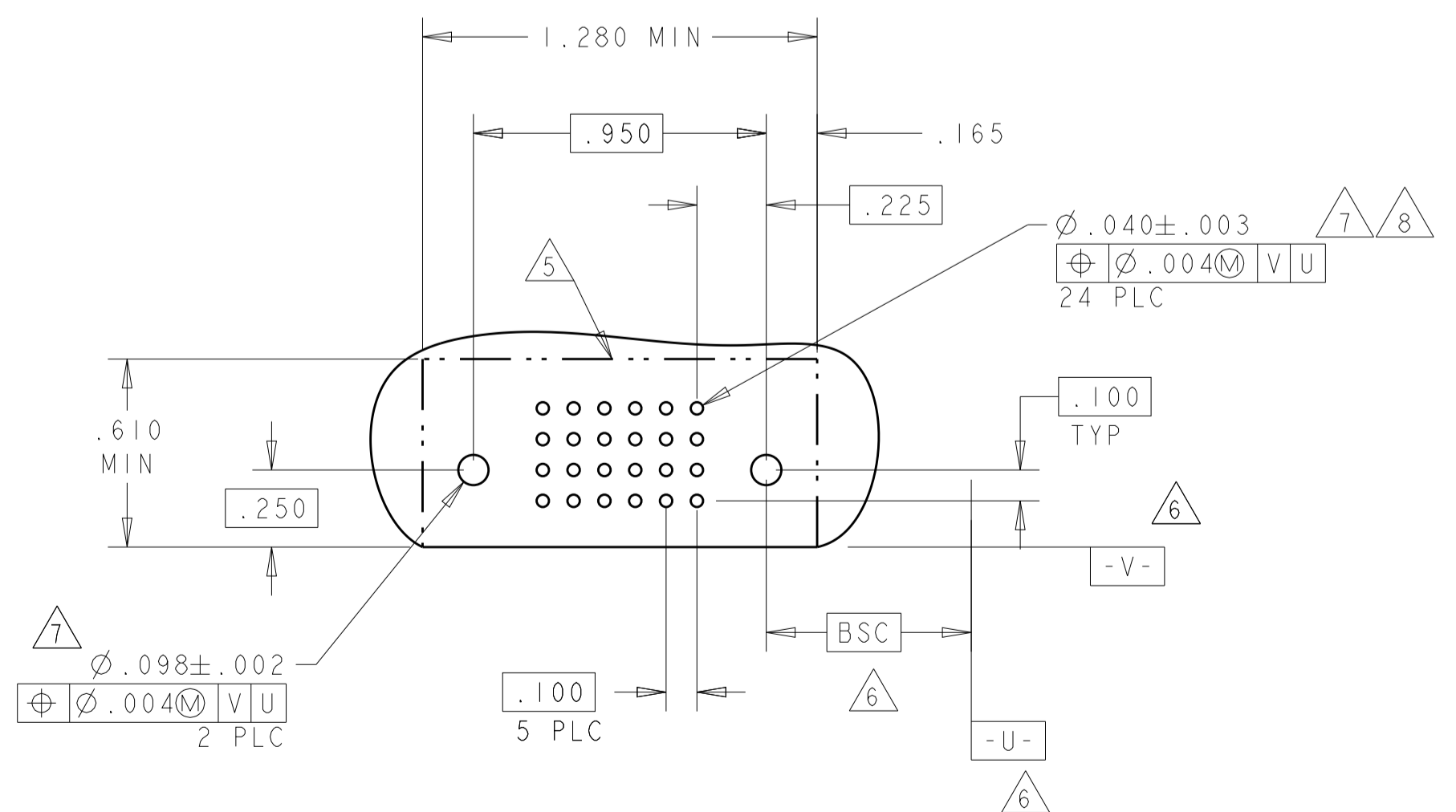

PART NUMBER	ROWS	POWER				SIGNAL POWER			
		P6	P5	P4	P3	2	1	P2	P1
I-6450160-1	D C B A	RA	RA	RA	RA	H	H	H	RA
						G	G	G	
						F	F	F	
1P + 12S + 5P									

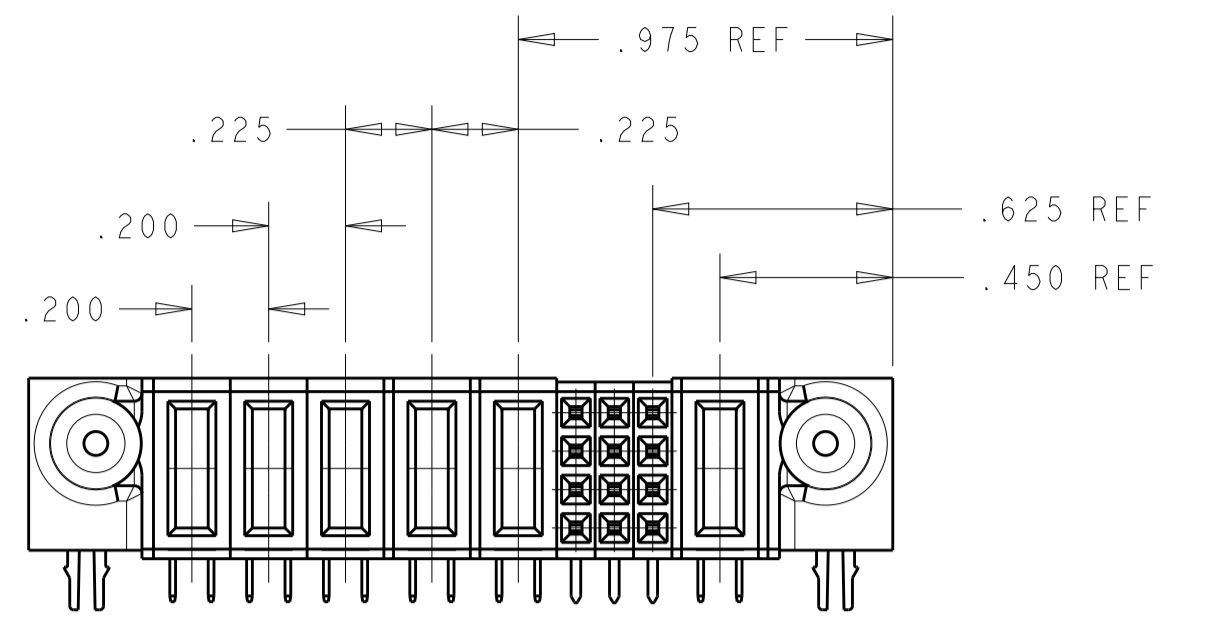
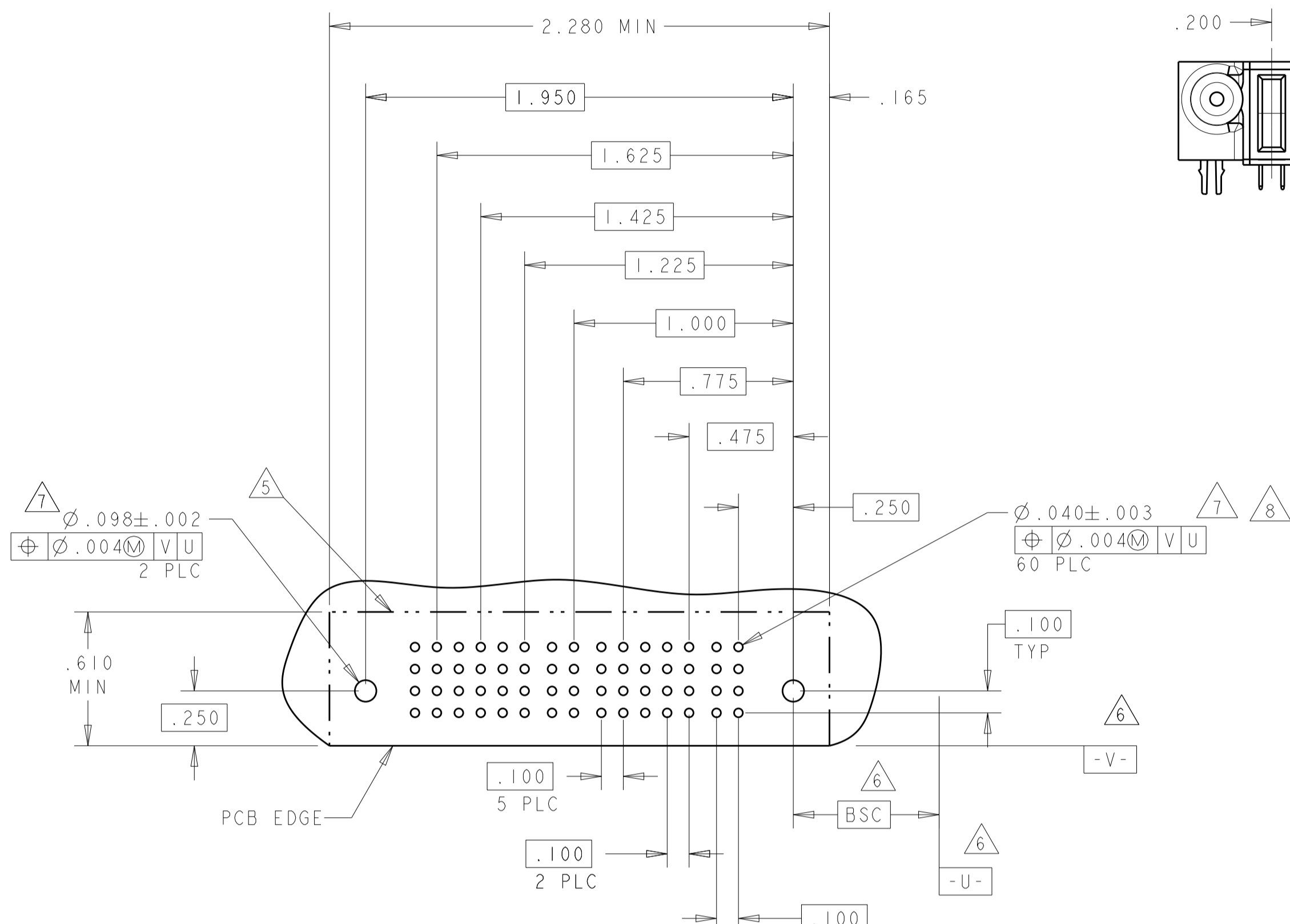

PART NUMBER	ROWS	POWER			SIGNAL				POWER						
		P10	P9	P8	7	5	4	3	2	1	P6	P5	P4	P3	P2
I-6450160-9	D C B A	RA	RA	RA	H	H	H	H	H	RA	RA	RA	RA	RA	RA
					G	G	G	G	G						
					F	F	F	F	F						
6P + 20S + 4P															

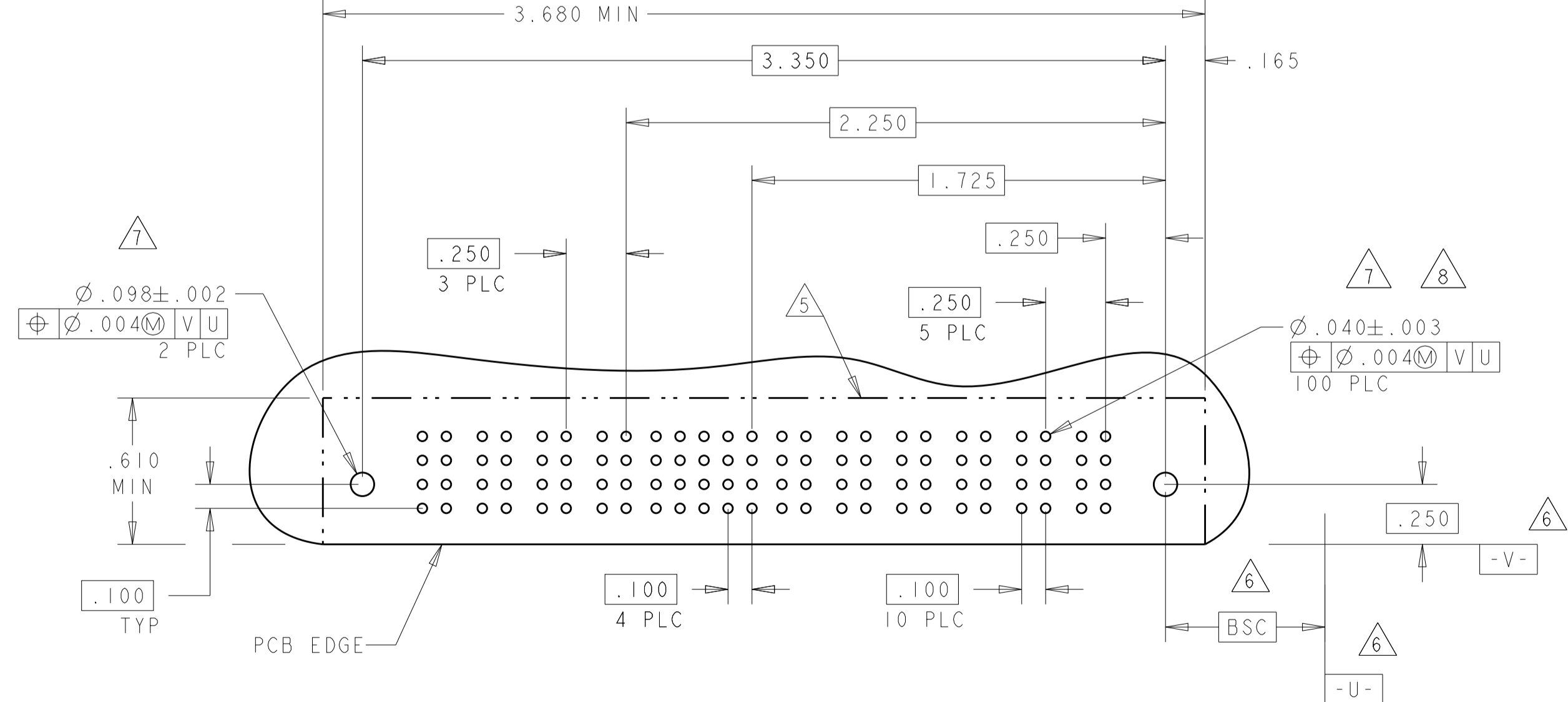

THIS DRAWING IS A CONTROLLED DOCUMENT. OWN: R. GRZYBOWSKI, ZIFEB05
 CHK: M. PERCHERKE, ZIFEB05
 APVD: M. PERCHERKE, ZIFEB05

STE TE Connectivity

NAME: RIGHT ANGLE RECEPTACLE ASSEMBLY WITH GUIDES MULTI-BEAM XL

PRODUCT SPEC: 108-1973
 APPLICATION SPEC: 114-13038
 WEIGHT: -
 MATERIAL: *** FINISH: ***

Customer Drawing

SCALE: 4:1 SHEET 5 OF 16 REV: G1

LOC	DIST	REVISIONS			
P	LTN	DESCRIPTION	DATE	OWN	APVD
GP	00	SEE SHEET 1			

PART NUMBER	ROWS	POWER					SIGNAL					POWER						
		P11	P10	P9	P8	P7	P6	M1	6	5	4	3	2	1	P5	P4	P3	P2
2-6450160-0	D C B A	RA	RA	RA	RA	RA	RA	H	H	H	H	H	H	RA	RA	RA	RA	RA
		RA	RA	RA	RA	RA	RA	G	G	G	G	G	G	RA	RA	RA	RA	RA
		RA	RA	RA	RA	RA	RA	F	F	F	F	F	F	RA	RA	RA	RA	RA
		RA	RA	RA	RA	RA	RA	E	E	E	E	E	E	RA	RA	RA	RA	RA

5P + 24S + 1M + 6P

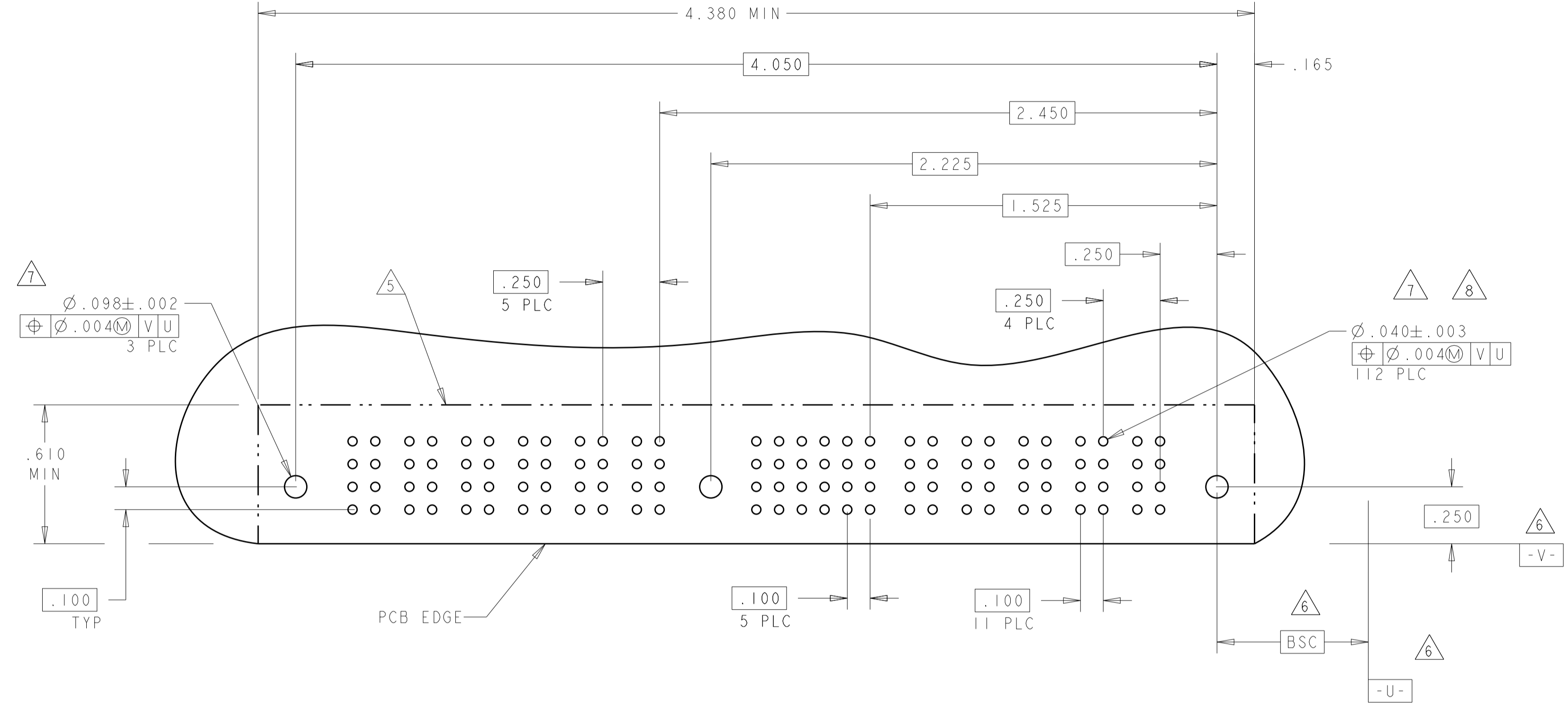

PART NUMBER	ROWS	POWER		SIGNAL					POWER		
		P4	P3	6	5	4	3	2	1	P2	P1
2-6450160-5	D C B A	RN	RN	L	L	L	L	L	L	RN	RN
		RN	RN	J	J	J	J	J	J	RN	RN
		RN	RN	T	T	T	T	T	T	RN	RN

2P + 24S + 2P

PART NUMBER	ROWS	POWER		SIGNAL					POWER		
		P4	P3	6	5	4	3	2	1	P2	P1
4-6450160-5	D C B A	RM	RM	H	H	H	H	H	H	RM	RM
		RM	RM	G	G	G	G	G	G	RM	RM
		RM	RM	F	F	F	F	F	F	RM	RM
		RM	RM	E	E	E	E	E	E	RM	RM

2P + 24S + 2P

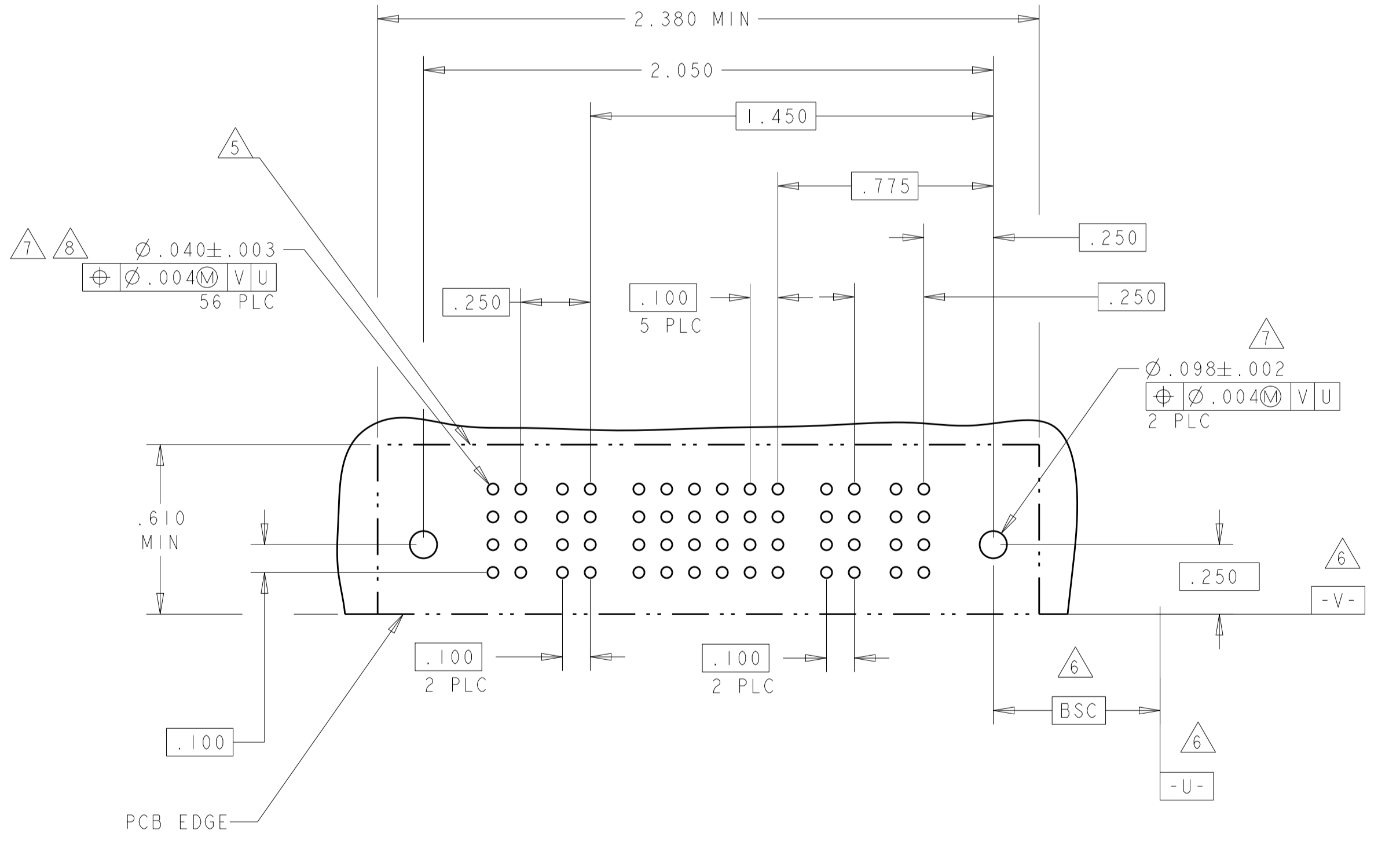

PART NUMBER	ROWS	POWER			SIGNAL					POWER			
		P8	P7	P6	P5	6	5	4	3	2	1	P4	P3
2-6450160-6	D C B A	RM	RM	RM	H	H	H	H	H	H	RM	RM	RM
		RM	RM	RM	G	G	G	G	G	G	RM	RM	RM
		RM	RM	RM	F	F	F	F	F	F	RM	RM	RM
		RM	RM	RM	E	E	E	E	E	E	RM	RM	RM

4HDP + 24S + 4HDP

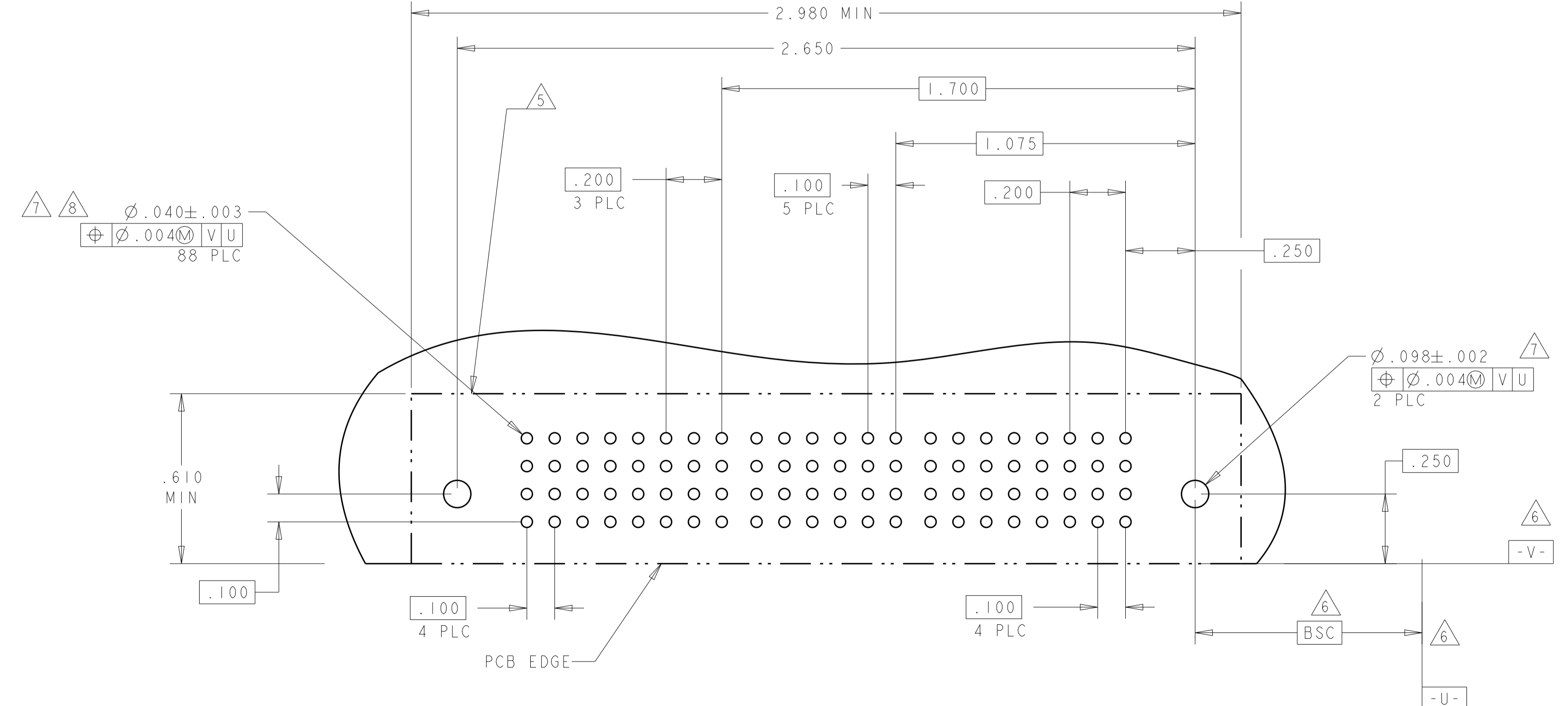

2-6450160-5 AND 4-6450160-5 PCB LAYOUT

THIS DRAWING IS A CONTROLLED DOCUMENT.		OWN: R. GRZYBOWSKI	ZIFEB05	 TE Connectivity
DIMENSIONS: INCHES		CHK: M. PERCHERKE	ZIFEB05	
TOLERANCES UNLESS OTHERWISE SPECIFIED:		APVD: M. PERCHERKE	ZIFEB05	NAME: RIGHT ANGLE RECEPTACLE ASSEMBLY WITH GUIDES MULTI-BEAM XL
0 PLC ±.01		PRODUCT SPEC		SIZE: CAGE CODE DRAWING NO
1 PLC ±.01		APPLICATION SPEC		RESTRICTED TO
2 PLC ±.01		108-1973		A100779
3 PLC ±.005		114-13038		C=6450160
4 PLC ±.002		WEIGHT		SCALE: 4:1
ANGLES ±.002		Customer Drawing		SHEET 6 OF 16

PART NUMBER	ROWS	POWER								SIGNAL						POWER			
		P12	P11	P10	P9	P8	P7	P6	P5	6	5	4	3	2	1	P4	P3	P2	P1
2-6450160-9	D C B A	RM	RM	RM	RM	RM	RM	RM	RM	H	H	H	H	H	H	RM	RM	RM	RM
4ACP + 24S + 8P										G	G	G	G	G	G				
										F	F	F	F	F	F				
										E	E	E	E	E	E				

PART NUMBER	ROWS	POWER			SIGNAL				POWER		
		P4	P3	P2	4	3	2	1	P2	P1	P1
3-6450160-1	D C B A	RM	RM	RM	H	H	H	H	RM	RM	RM
					G	G	G	G			
					F	F	F	F			
					E	E	E	E			

2P + 16S + 2P

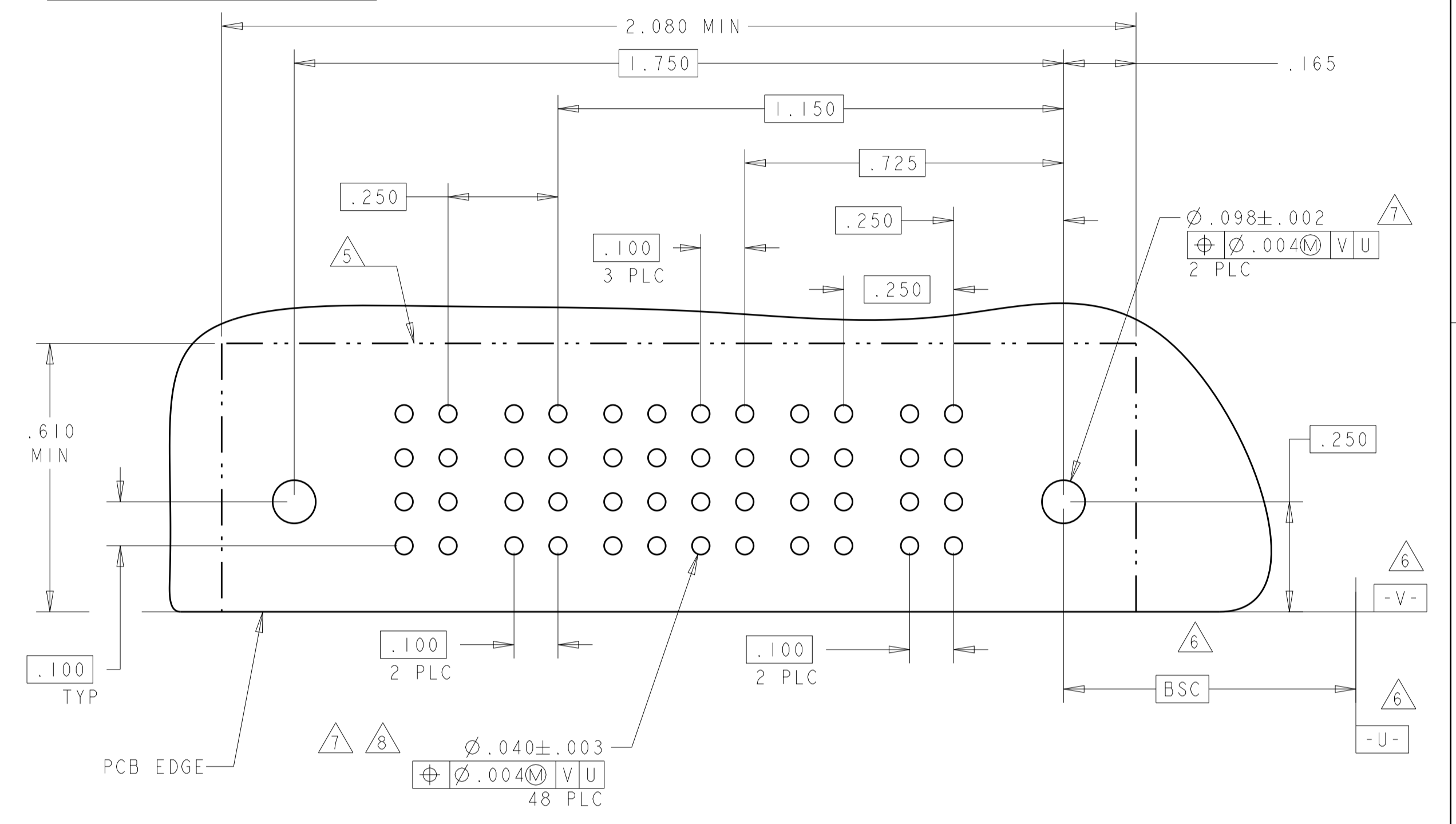
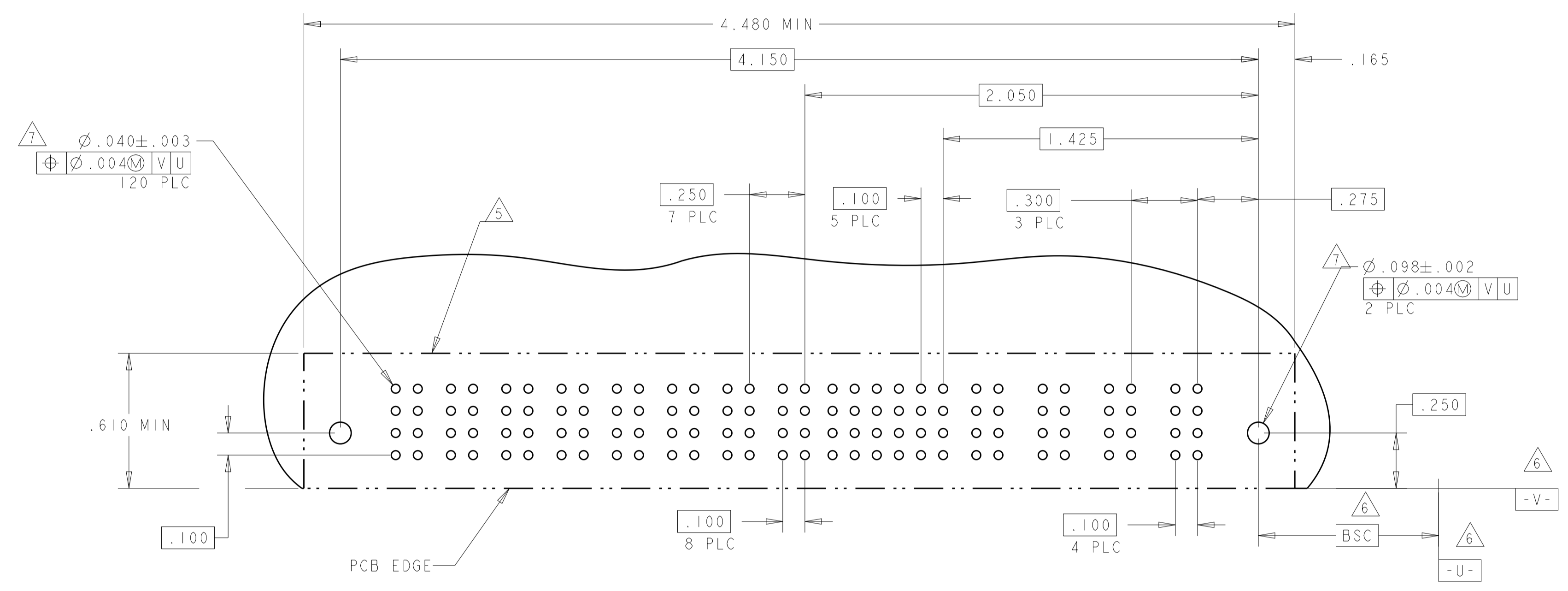

PART NUMBER	ROWS	POWER				SIGNAL						POWER							
		P12	P11	P10	P9	6	5	4	3	2	1	P8	P7	P6	P5	P4	P3	P2	P1
3-6450160-0	D C B A	RM	RM	RM	RM	H	H	H	H	H	H	RM	RM	RM	RM	RM	RM	RM	RM
						G	G	G	G	G	G								
						F	F	F	F	F	F								
						E	E	E	E	E	E								

8P + 24S + 1M + 4ACP

PART NUMBER	HOUSING P/N	ROWS	POWER			SIGNAL						POWER			
			P7	P6	P5	6	5	4	3	2	1	P4	P3	P2	P1
3-6450160-2	3-1450190-2	D C B A	RM	RM	RM	H	H	H	H	H	H	RM	RM	RM	RM
						G	G	G	G	G	G				
						F	F	F	F	F	F				
						E	E	E	E	E	E				

4P + 24S + 3ACP

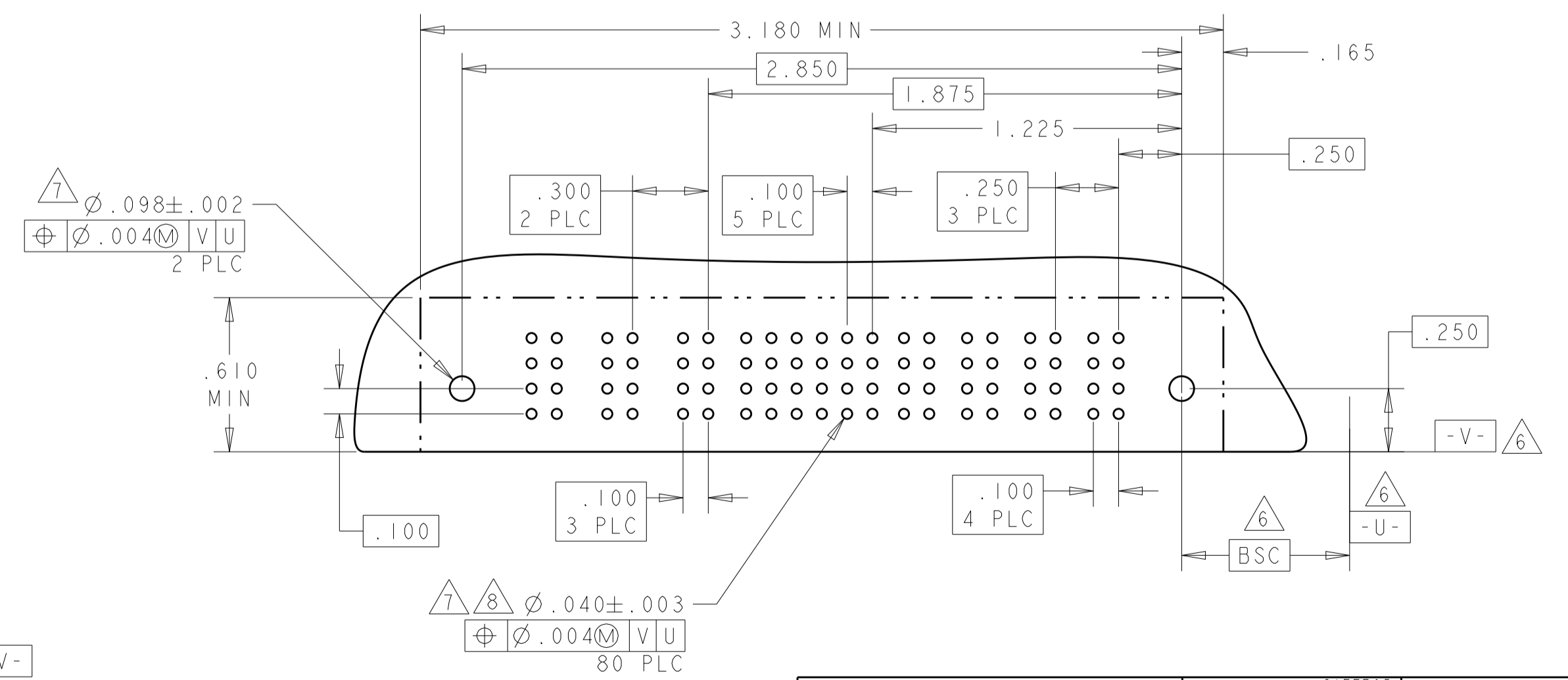
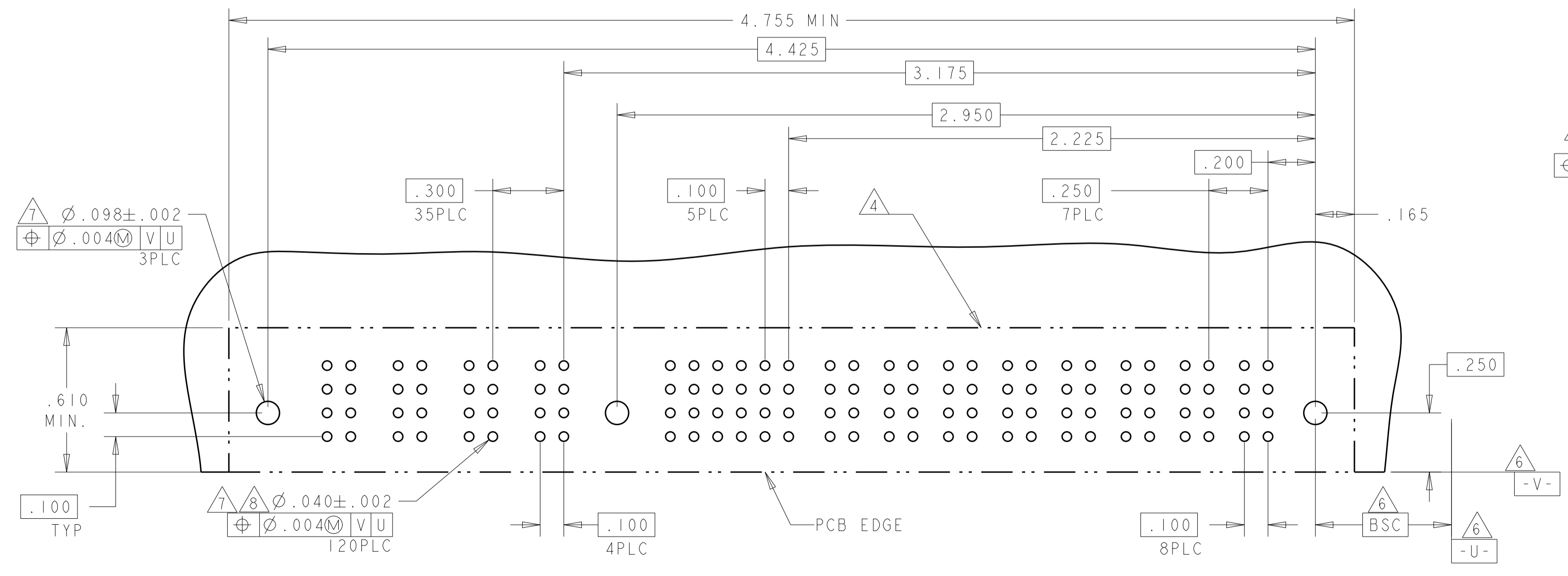

THIS DRAWING IS A CONTROLLED DOCUMENT.

OWN: R. GRZYBOWSKI	ZIFEB05	 TE Connectivity
CHK: M. PERCHERKE	ZIFEB05	
APPV: M. PERCHERKE	ZIFEB05	
NAME: RIGHT ANGLE RECEPTACLE ASSEMBLY WITH GUIDES MULTI-BEAM XL		
DIMENSIONS: INCHES	TOLERANCES UNLESS OTHERWISE SPECIFIED:	SIZE: A100779
0 PLC ±.01	1 PLC ±.01	CAGE CODE: 6450160
2 PLC ±.01	3 PLC ±.01	SCALE: 3:1
4 PLC ±.005	5 PLC ±.005	SHEET 7 OF 16
6 PLC ±.002	ANGLES ±.002	REV: G1
MATERIAL:	FINISH:	Customer Drawing

LOC	DIST	REVISIONS			
P	LTN	DESCRIPTION	DATE	DWN	APVD
GP	00	SEE SHEET 1			

PART NUMBER	ROWS	POWER				SIGNAL								POWER							
		P12	P11	P10	P9	6	5	4	3	2	1	P8	P7	P6	P5	P4	P3	P2	P1		
3-6450160-3	D C B A	RM	RM	RM	RM	H	H	H	H	H	H	RM	RM	RM	RM	RM	RM	RM	RM		
		RM	RM	RM	RM	G	G	G	G	G	G	RM	RM	RM	RM	RM	RM	RM	RM		
		RM	RM	RM	RM	F	F	F	F	F	F	RM	RM	RM	RM	RM	RM	RM	RM		
		RM	RM	RM	RM	E	E	E	E	E	E	RM	RM	RM	RM	RM	RM	RM	RM		
8P + 24S + 4ACP																					

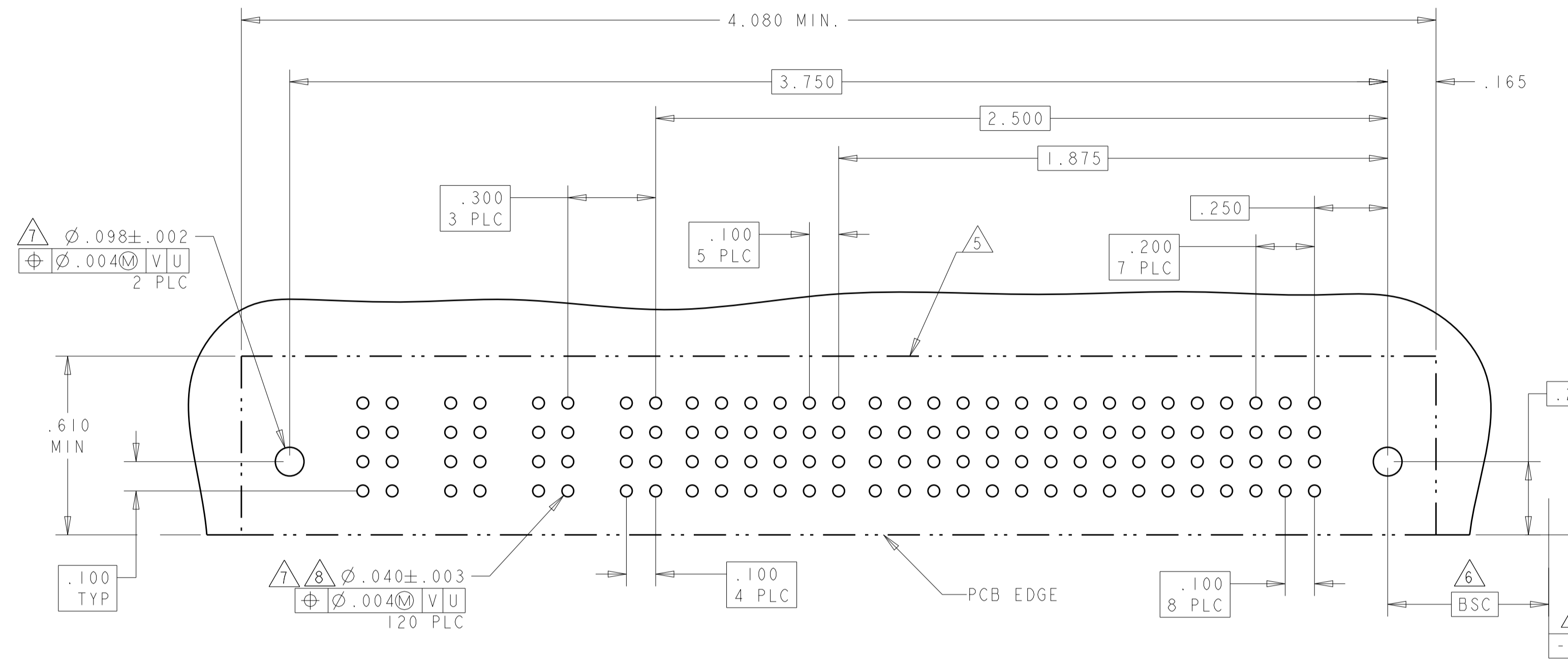

PART NUMBER	ROWS	POWER		SIGNAL																				POWER							
		P4	P3	25	24	23	22	21	20	19	18	17	16	15	14	13	12	11	10	9	8	7	6	5	4	3	2	1	P2	P1	
3-6450160-4	D C B A	RM	RM	H	H	H	H	H	H	H	H	H	H	H	H	H	H	H	H	H	H	H	H	H	H	H	H	H	H	RM	RM
		RM	RM	G	G	G	G	G	G	G	G	G	G	G	G	G	G	G	G	G	G	G	G	G	G	G	G	G	G	RM	RM
		RM	RM	F	F	F	F	F	F	F	F	F	F	F	F	F	F	F	F	F	F	F	F	F	F	F	F	F	F	RM	RM
		RM	RM	E	E	E	E	E	E	E	E	E	E	E	E	E	E	E	E	E	E	E	E	E	E	E	E	E	E	RM	RM
2P + 100S + 2P																															

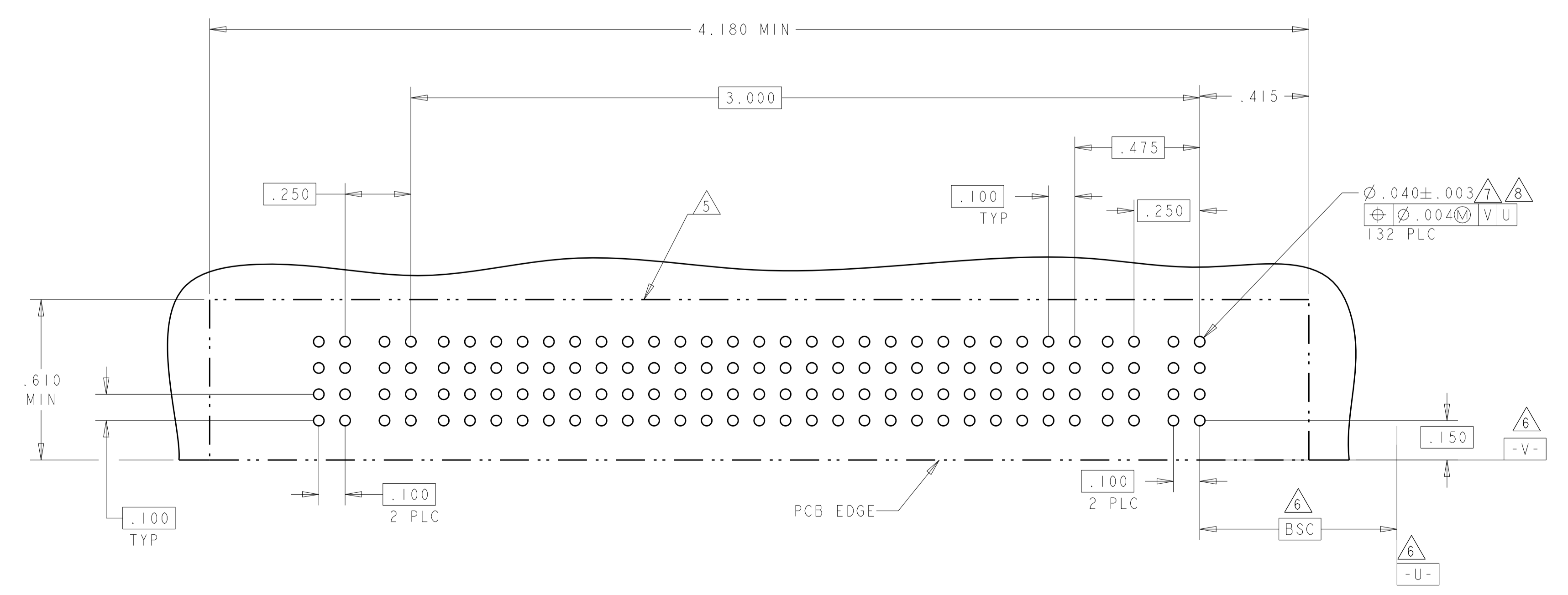

THIS DRAWING IS A CONTROLLED DOCUMENT.		DWN: R. GRZYBOWSKI 21FEB05	 TE Connectivity
DIMENSIONS: INCHES		CHK: M. PERCHERKE 21FEB05	
TOLERANCES UNLESS OTHERWISE SPECIFIED:		APVD: M. PERCHERKE 21FEB05	NAME: RIGHT ANGLE RECEPTACLE ASSEMBLY WITH GUIDES MULTI-BEAM XL
0 PLC ±. 1 PLC ±.01 2 PLC ±.01 3 PLC ±.005 4 PLC ±.002 ANGLES ±.2°		PRODUCT SPEC: 108-1973	SIZE: A100779
MATERIAL: FINISH:		APPLICATION SPEC: 114-13038	CAGE CODE: C=6450160
		WEIGHT:	RESTRICTED TO: -
		Customer Drawing	SCALE: 3:1 SHEET 8 OF 16 REV: G1

LOC	DIST	REV	DATE	BY	APPV
GP	00				

REVISIONS		DATE	BY	APPV
1	SEE SHEET 1			

PART NUMBER	ROWS	POWER					SIGNAL					POWER						
		P12	P11	P10	P9	P8	6	5	4	3	2	1	P6	P5	P4	P3	P2	P1
3-6450160-6	D C B A	RM	RM	RM	RM	RM	H	H	H	H	H	H	RM	RM	RM	RM	RM	RM
		HD					E	E	E	E	E	E						HD
		6P + 24S + 6P																

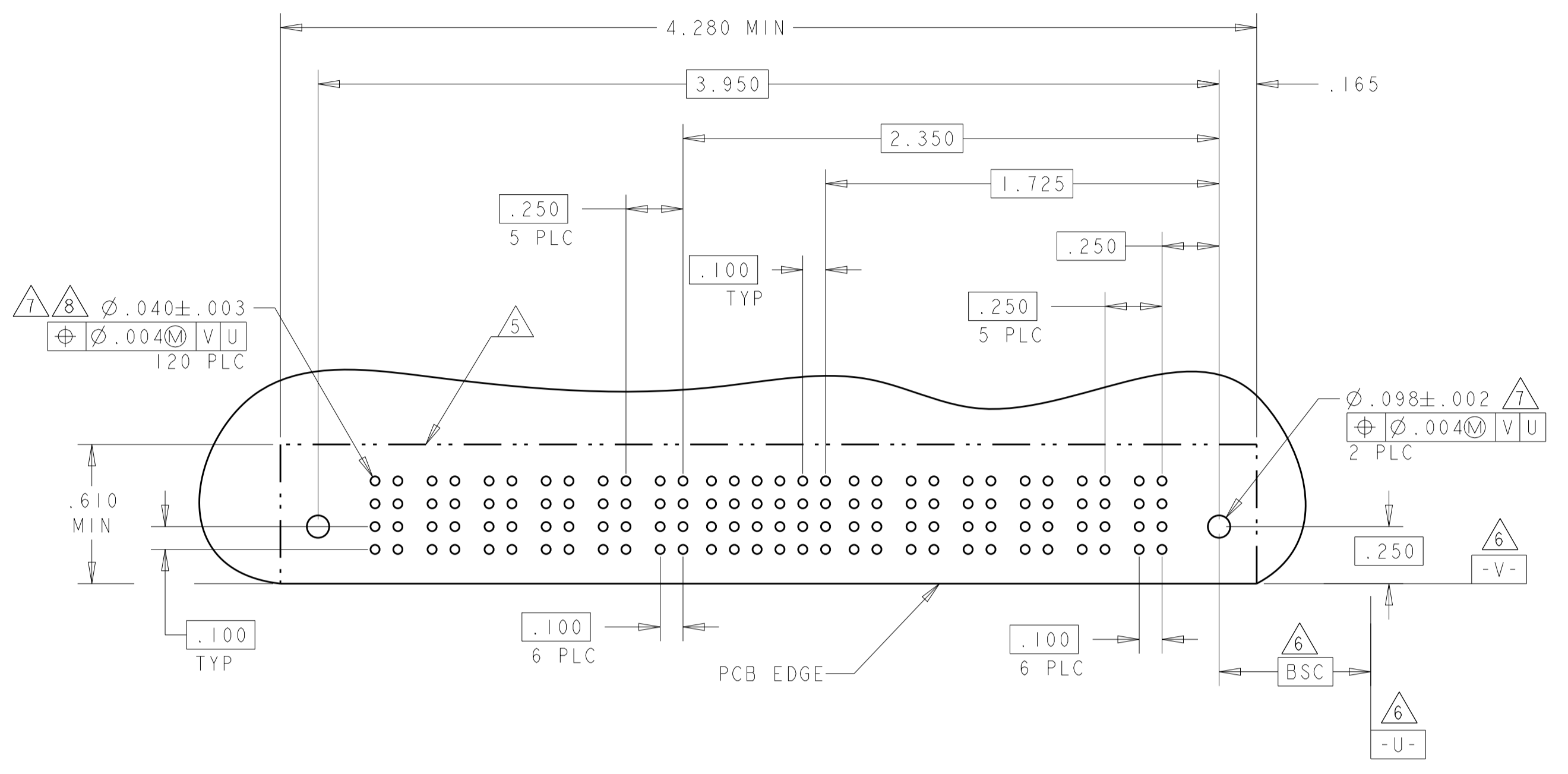

PART NUMBER	ROWS	POWER				SIGNAL					POWER				
		P8	P7	P6	P5	6	5	4	3	2	1	P4	P3	P2	P1
3-6450160-7	D C B A	RM	RM	RM	RM	H	H	H	H	H	H	RM	RM	RM	RM
		HD				F	F	F	F	F	F				HD
		4P + 24S + 4P													

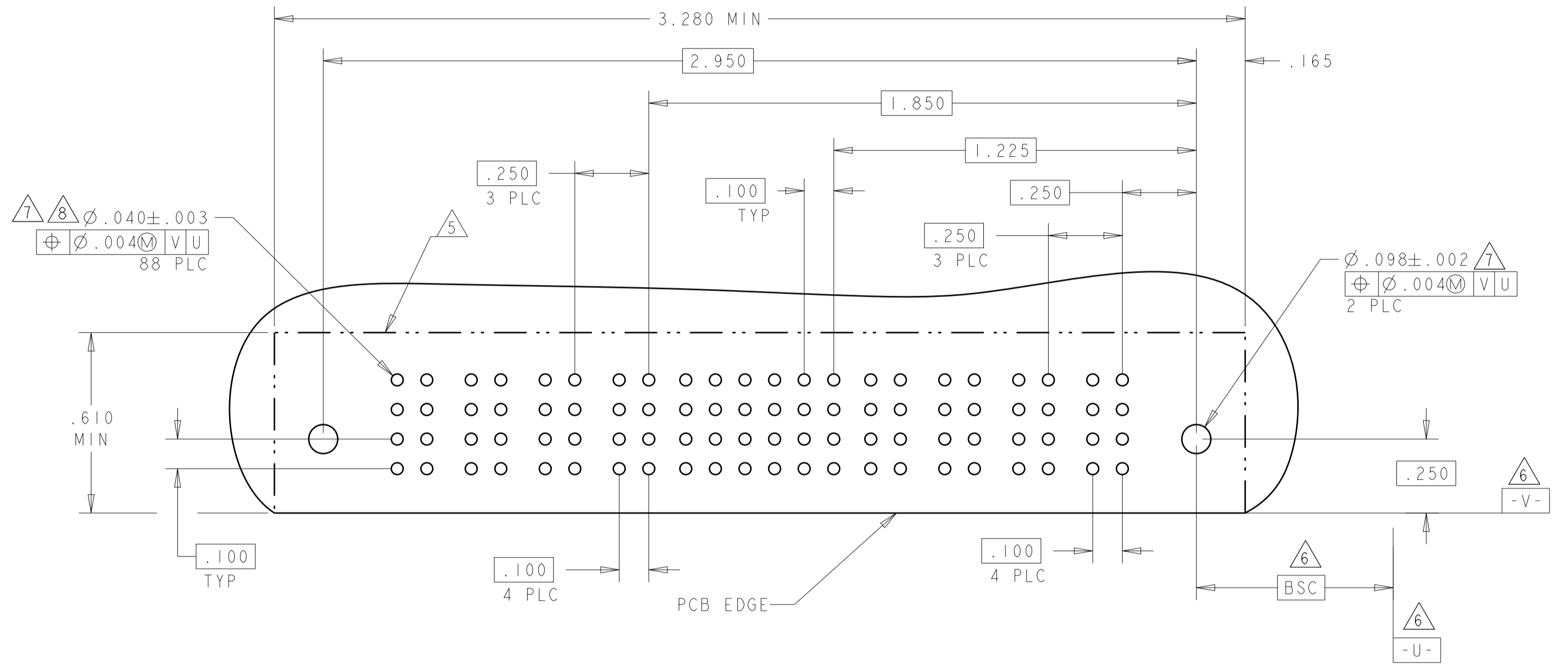

THIS DRAWING IS A CONTROLLED DOCUMENT.

DIMENSIONS:	TOLERANCES UNLESS OTHERWISE SPECIFIED:	OWN: R. GRZYBOWSKI 21FEB05	CHK: M. PERCHERKE 21FEB05	APV: M. PERCHERKE 21FEB05	NAME: RIGHT ANGLE RECEPTACLE ASSEMBLY WITH GUIDES MULTI-BEAM XL
INCHES	0 PLC ±.01 1 PLC ±.01 2 PLC ±.01 3 PLC ±.01 4 PLC ±.005 ANGLES ±.002	PRODUCT SPEC: 108-1973	APPLICATION SPEC: 114-13038	WEIGHT: -	SIZE: A100779
MATERIAL:	FINISH: #2	RESTRICTED TO: -	SCALE: 3:1	SHEET: 9	OF: 16

Customer Drawing

LOC	DIST	REVISIONS			
P	LTN	DESCRIPTION	DATE	DMN	APVD
-	-	SEE SHEET 1	-	-	-

PART NUMBER	ROWS	AC POWER			SIGNAL					POWER													
		P15	P14	P13	5	4	3	2	1	P12	P11	P10	P9	P8	P7	P6	P5	P4	P3	P2	P1		
1-6450160-8	D C B A	RA	RA	RA	H	H	H	H	H	RA	RA	RA	RA	RA	RA	RA	RA	RA	RA	RA	RA	RA	RA
					G	G	G	G	G														
					F	F	F	F	F														
12P + 20S + 3ACP		E E E E E																					

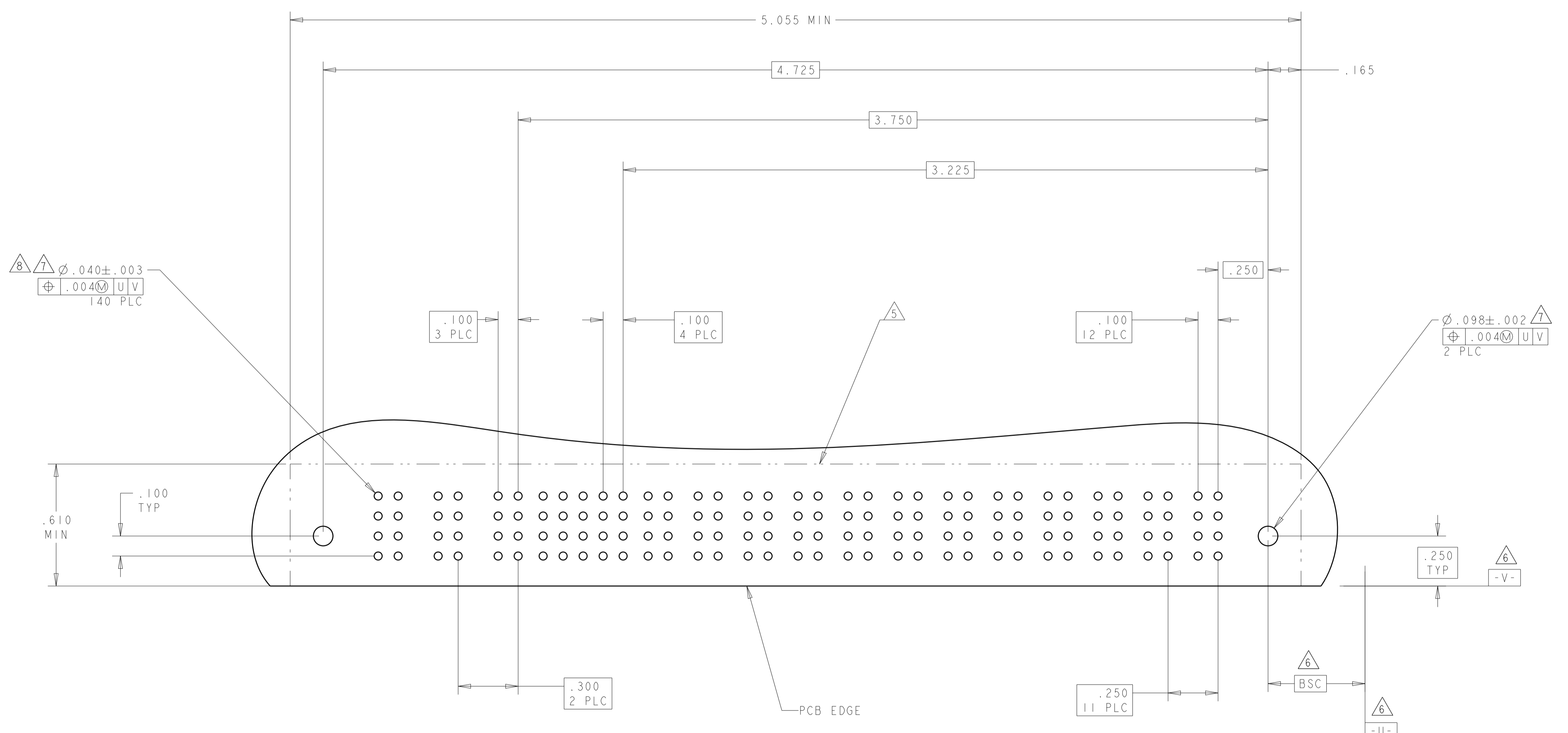

THIS DRAWING IS A CONTROLLED DOCUMENT.		DMN: R. GRZYBOWSKI 21FEB05	TE Connectivity														
DIMENSIONS: INCHES		CHK: M. PERCHERKE 21FEB05															
TOLERANCES UNLESS OTHERWISE SPECIFIED:		APVD: M. PERCHERKE 21FEB05	NAME: RIGHT ANGLE RECEPTACLE ASSEMBLY WITH GUIDES MULTI-BEAM XL														
<table border="1"> <tr> <td>0 PLC</td> <td>±</td> </tr> <tr> <td>1 PLC</td> <td>±.01</td> </tr> <tr> <td>2 PLC</td> <td>±.01</td> </tr> <tr> <td>3 PLC</td> <td>±.005</td> </tr> <tr> <td>4 PLC</td> <td>±.002</td> </tr> <tr> <td>ANGLES</td> <td>±.2°</td> </tr> <tr> <td>FINISH</td> <td></td> </tr> </table>		0 PLC	±	1 PLC	±.01	2 PLC	±.01	3 PLC	±.005	4 PLC	±.002	ANGLES	±.2°	FINISH		PRODUCT SPEC: 108-1973	SIZE: A1
0 PLC	±																
1 PLC	±.01																
2 PLC	±.01																
3 PLC	±.005																
4 PLC	±.002																
ANGLES	±.2°																
FINISH																	
MATERIAL:		APPLICATION SPEC: 114-13038	CAGE CODE: C=6450160														
WEIGHT:		RESTRICTED TO:	SCALE: 3:1 SHEET 10 OF 16 REV: G1														
Customer Drawing																	

LOC		DIST		REVISIONS				
P	LTN	DESCRIPTION	DATE	DMN	APVD			
-	-	SEE SHEET 1	-	-	-			

PART NUMBER	ROWS	POWER								SIGNAL					POWER					HD							
		P15	P14	P13	P12	P11	P10	P9	P8	P7	P6	P5	P4	P3	P2	P1	P6	P5	P4		P3	P2	P1				
3-6450160-8	D C B A										H	H		H	H												
		RM	RM	RM			RM	RM	RM		G	G		G	G	RA											
											F	F		F	F												
											E	E		E	E												
6P + 24S + 9P																											

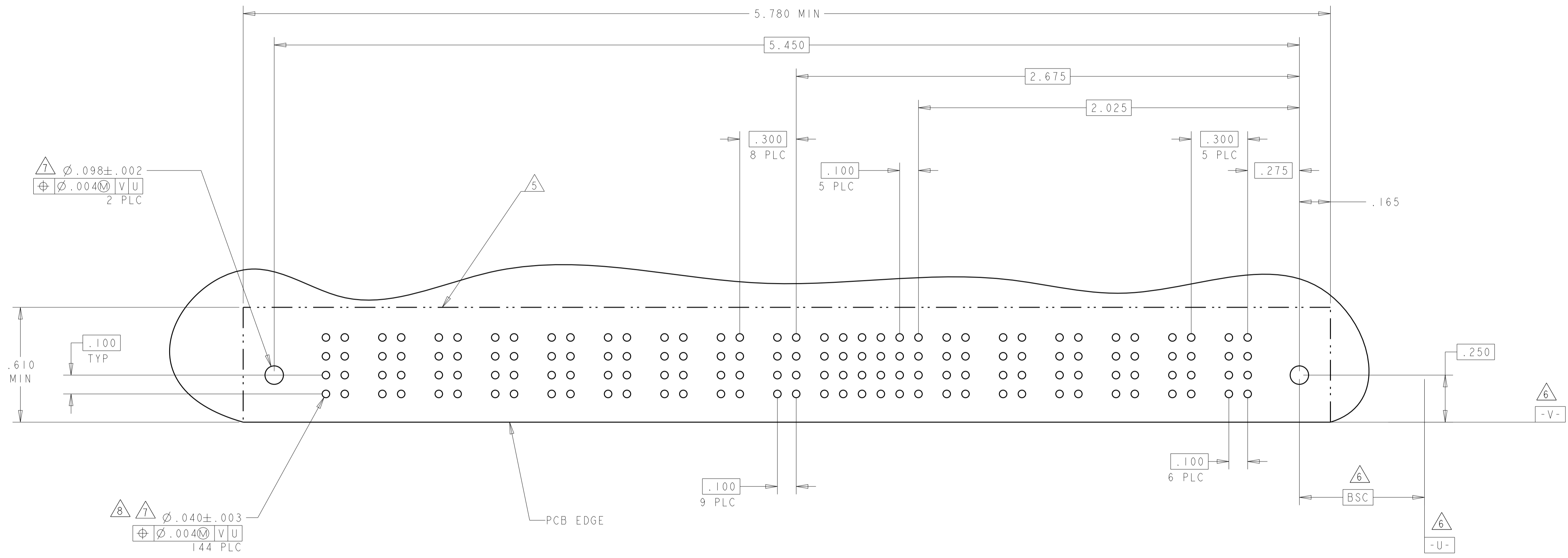

THIS DRAWING IS A CONTROLLED DOCUMENT.

DMN: R. GRZYBOWSKI Z1FEB05
 CHK: M. PERCHERKE Z1FEB05
 APVD: M. PERCHERKE Z1FEB05

STE TE Connectivity

NAME: RIGHT ANGLE RECEPTACLE ASSEMBLY WITH GUIDES MULTI-BEAM XL

PRODUCT SPEC: 108-1973
 APPLICATION SPEC: 114-13038

SIZE: A100779 C=6450160
 CAGE CODE: 114-13038
 DRAWING NO: 6450160

MATERIAL: Customer Drawing
 FINISH: -

RESTRICTED TO: -

SCALE: 3:1 SHEET 11 OF 16 REV: G1

LOC	DIST	REVISIONS			
P	LTN	DESCRIPTION	DATE	DMN	APVD
-	-	SEE SHEET 1	-	-	-

PART NUMBER	ROWS	POWER							SIGNAL				POWER								
		P16	P15	P14	P13	P12	P11	P10	P9	4	3	2	1	P8	P7	P6	P5	P4	P3	P2	P1
3-6450160-9	D								H	H	H	H									
	C	RM	RM	RM	RM	RM	RM	RM	G	G	G	G	RM	RM	RM	RM	RM	RM	RM	RM	
	B								F	F	F	F									
	A	HD							E	E	E	E								HD	
8P + 16S + 8P																					

(D5)

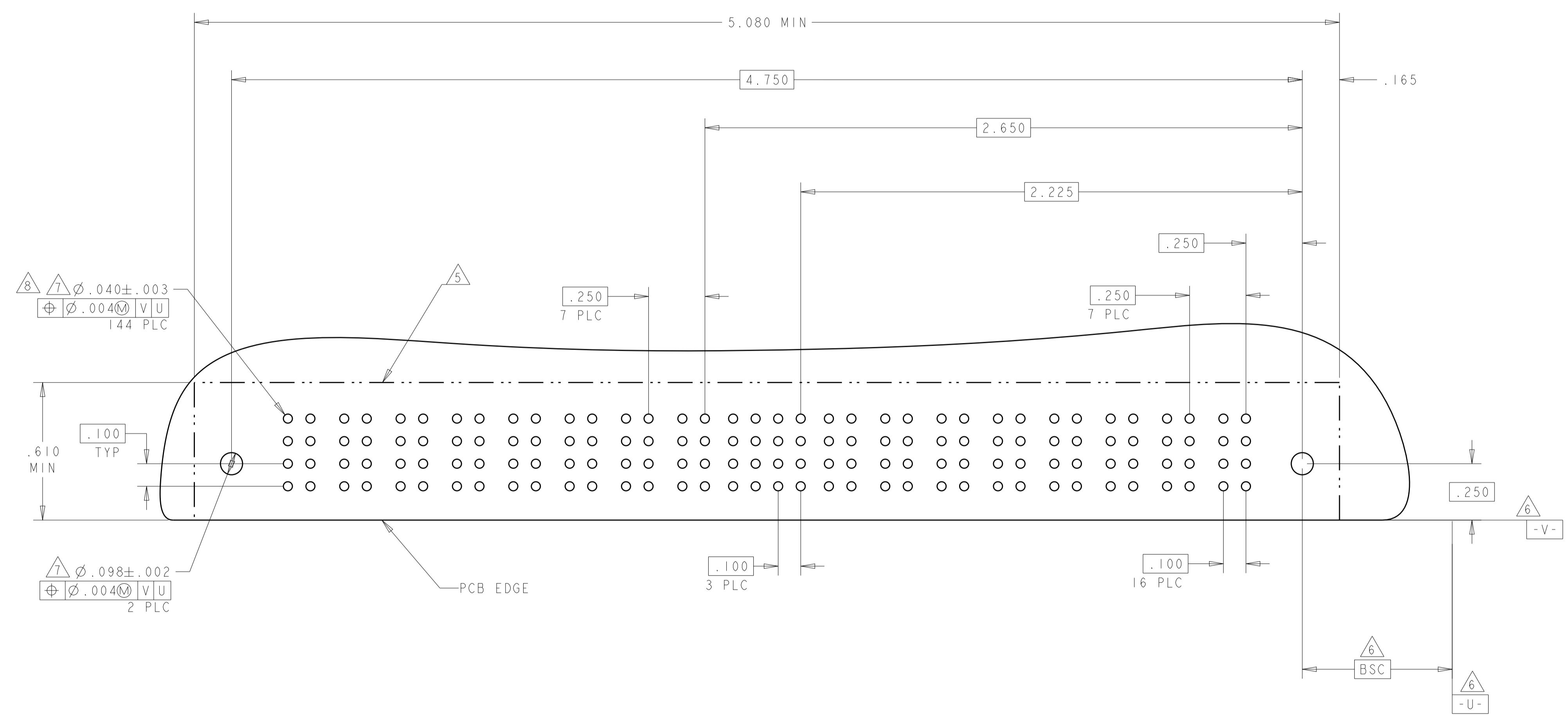

THIS DRAWING IS A CONTROLLED DOCUMENT.		DMN R. GRZYBOWSKI CHK M. PERCHERKE APVD M. PERCHERKE	Z1FEB05 Z1FEB05 Z1FEB05	 TE Connectivity	NAME RIGHT ANGLE RECEPTACLE ASSEMBLY WITH GUIDES MULTI-BEAM XL
DIMENSIONS: INCHES	TOLERANCES UNLESS OTHERWISE SPECIFIED:	PRODUCT SPEC 108-1973	APPLICATION SPEC 114-13038		SIZE A100779
MATERIAL	FINISH	WEIGHT	Customer Drawing	SCALE 3:1	SHEET 12 OF 16

LOC		DIST		REVISIONS			
P	LTN	DATE	DWN	APVD			

PART NUMBER	ROWS	POWER				SIGNAL						POWER	
		P6	P5	P4	P3	6	5	4	3	2	1	P2	P1
4-6450160-0	D	RM	RM	RM	RM	H	H	H	H	H	H	RM	RM
	C					G	G	G	G	G	G		
	B					F	F	F	F	F	F		
	A					E	E	E	E	E	E		
2P + 24S + 4P		HD											HD

PART NUMBER	ROWS	POWER		SIGNAL			POWER	
		P2	3	2	1	P1		
4-6450160-1	D	RM	RM	H	H	H	RM	RM
	C			G	G	G		
	B			F	F	F		
	A			E	E	E		
IP + 12S + IP		HD						HD

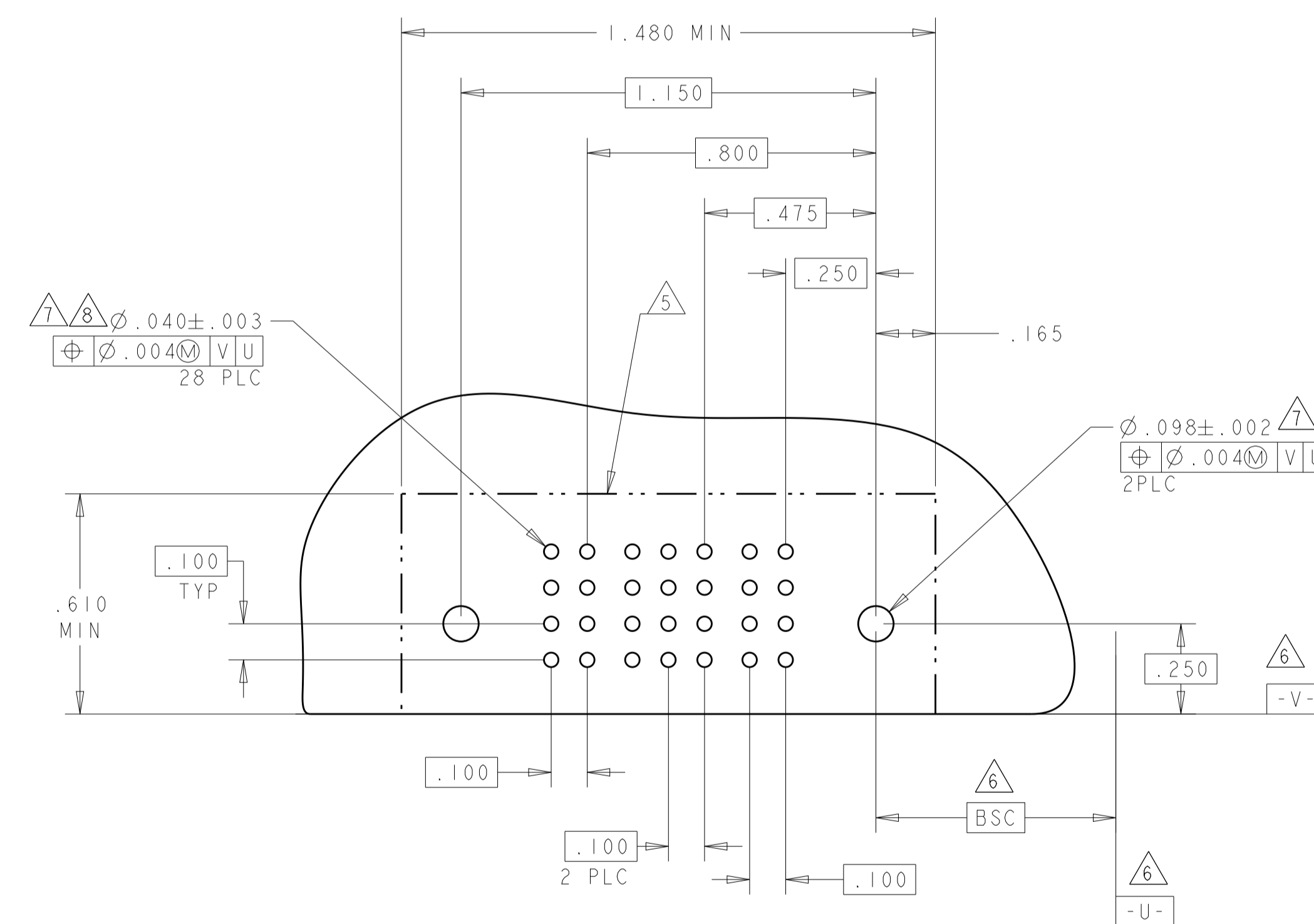
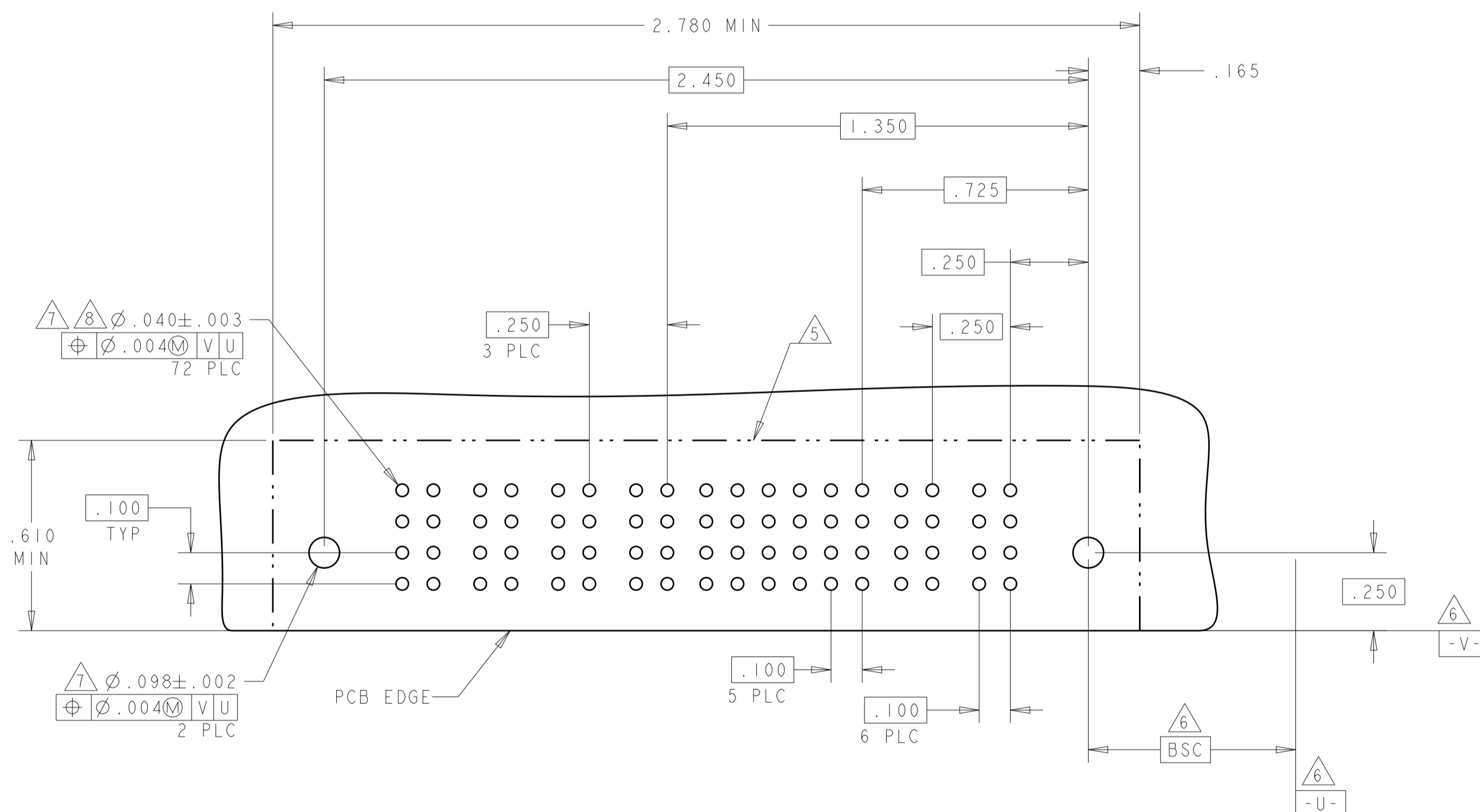

THIS DRAWING IS A CONTROLLED DOCUMENT.		DWN R. GRZYBOWSKI CHK M. PERCHERKE APVD M. PERCHERKE	Z1FEB05 Z1FEB05 Z1FEB05		TE Connectivity
DIMENSIONS: INCHES	TOLERANCES UNLESS OTHERWISE SPECIFIED: 0 PLC ±. 2 PLC ±.01 3 PLC ±.05 4 PLC ±.002 ANGLES ±.7°	FINISH	NAME RIGHT ANGLE RECEPTACLE ASSEMBLY WITH GUIDES MULTI-BEAM XL		SIZE A100779
MATERIAL	Customer Drawing	WEIGHT	SCALE 3:1	SHEET 13	OF 16
					REV G1

LOC	DIST	REVISIONS			
P	LTN	DESCRIPTION	DATE	DWN	APVD
-	-	SEE SHEET 1	-	-	-

PART NUMBER	ROWS	SIGNAL																							
		25	24	23	22	21	20	19	18	17	16	15	14	13	12	11	10	9	8	7	6	5	4	3	2
4-6450160-4	D	H	H	H	H	H	H	H	H	H	H	H	H	H	H	H	H	H	H	H	H	H	H	H	H
	C	G	G	G	G	G	G	G	G	G	G	G	G	G	G	G	G	G	G	G	G	G	G	G	G
	B	F	F	F	F	F	F	F	F	F	F	F	F	F	F	F	F	F	F	F	F	F	F	F	F
	A	E	E	E	E	E	E	E	E	E	E	E	E	E	E	E	E	E	E	E	E	E	E	E	E
100S																									

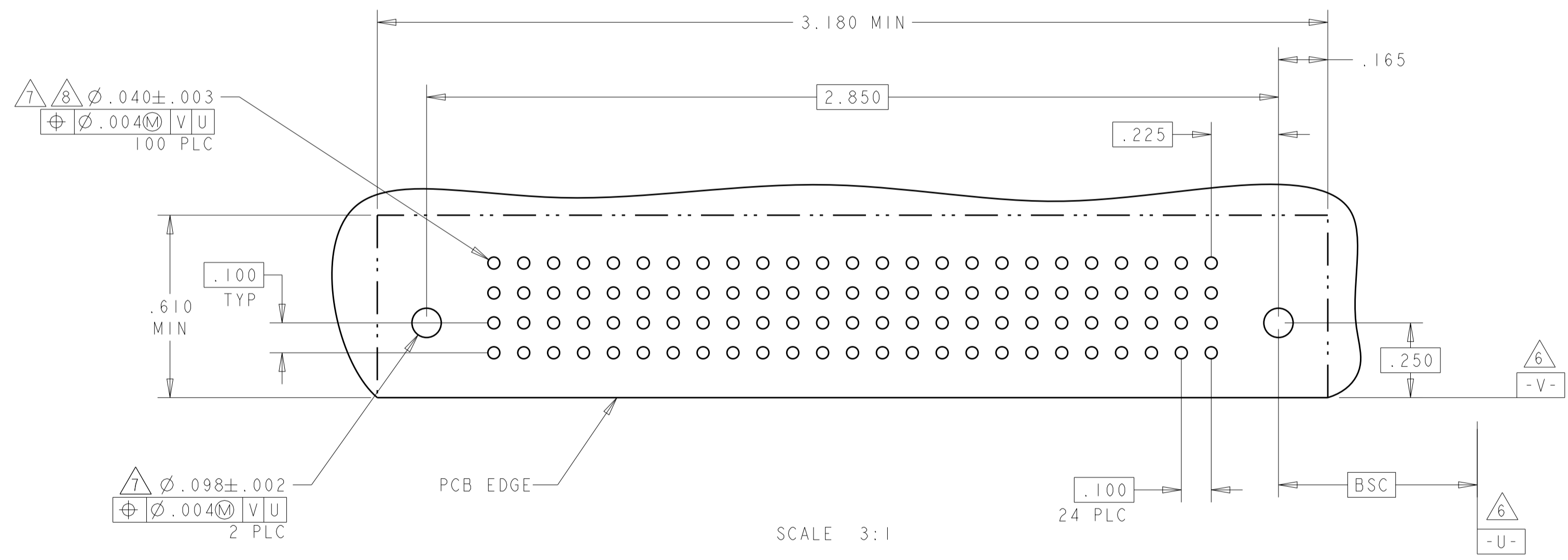

SCALE 3:1

THIS DRAWING IS A CONTROLLED DOCUMENT.		DWN R. GRZYBOWSKI CHK M. PERCHERKE APVD M. PERCHERKE	Z1FEB05 Z1FEB05 Z1FEB05	TE Connectivity RIGHT ANGLE RECEPTACLE ASSEMBLY WITH GUIDES MULTI-BEAM XL												
DIMENSIONS: INCHES	TOLERANCES UNLESS OTHERWISE SPECIFIED:	PRODUCT SPEC 108-1973	APPLICATION SPEC 114-13038													
<table border="1"> <tr><td>0 PLC</td><td>±</td></tr> <tr><td>1 PLC</td><td>±.01</td></tr> <tr><td>2 PLC</td><td>±.01</td></tr> <tr><td>3 PLC</td><td>±.005</td></tr> <tr><td>4 PLC</td><td>±.002</td></tr> </table>	0 PLC	±	1 PLC	±.01	2 PLC	±.01	3 PLC	±.005	4 PLC	±.002	<table border="1"> <tr><td>ANGLES</td><td>±2°</td></tr> </table>	ANGLES	±2°	SIZE A100779	CAGE CODE C=6450160	RESTRICTED TO -
0 PLC	±															
1 PLC	±.01															
2 PLC	±.01															
3 PLC	±.005															
4 PLC	±.002															
ANGLES	±2°															
MATERIAL	FINISH	WEIGHT	Customer Drawing	SCALE 3:1 SHEET 14 OF 16 REV G1												

LOC	DIST	REVISIONS			
P	LTN	DESCRIPTION	DATE	DMN	APVD
-	-	SEE SHEET 1	-	-	-

PART NUMBER	ROWS	POWER		SIGNAL		POWER		
		P5	P4	2	1	P3	P2	P1
2-6450160-7	D	RM	RM	H	H	RM	RM	RM
	C			G	G			
	B			F	F			
	A			E	E			
3ACP + 8S + 2P		HD		HD				

PART NUMBER	ROWS	SIGNAL																																			
		37	36	35	34	33	32	31	30	29	28	27	26	25	24	23	22	21	20	19	18	17	16	15	14	13	12	11	10	9	8	7	6	5	4	3	2
4-6450160-6	D	H	H	H	H	H	H	H	H	H	H	H	H	H	H	H	H	H	H	H	H	H	H	H	H	H	H	H	H	H	H	H	H	H	H	H	H
	C	G	G	G	G	G	G	G	G	G	G	G	G	G	G	G	G	G	G	G	G	G	G	G	G	G	G	G	G	G	G	G	G	G	G	G	G
	B	F	F	F	F	F	F	F	F	F	F	F	F	F	F	F	F	F	F	F	F	F	F	F	F	F	F	F	F	F	F	F	F	F	F	F	F
	A	E	E	E	E	E	E	E	E	E	E	E	E	E	E	E	E	E	E	E	E	E	E	E	E	E	E	E	E	E	E	E	E	E	E	E	E
148S		HD																																			

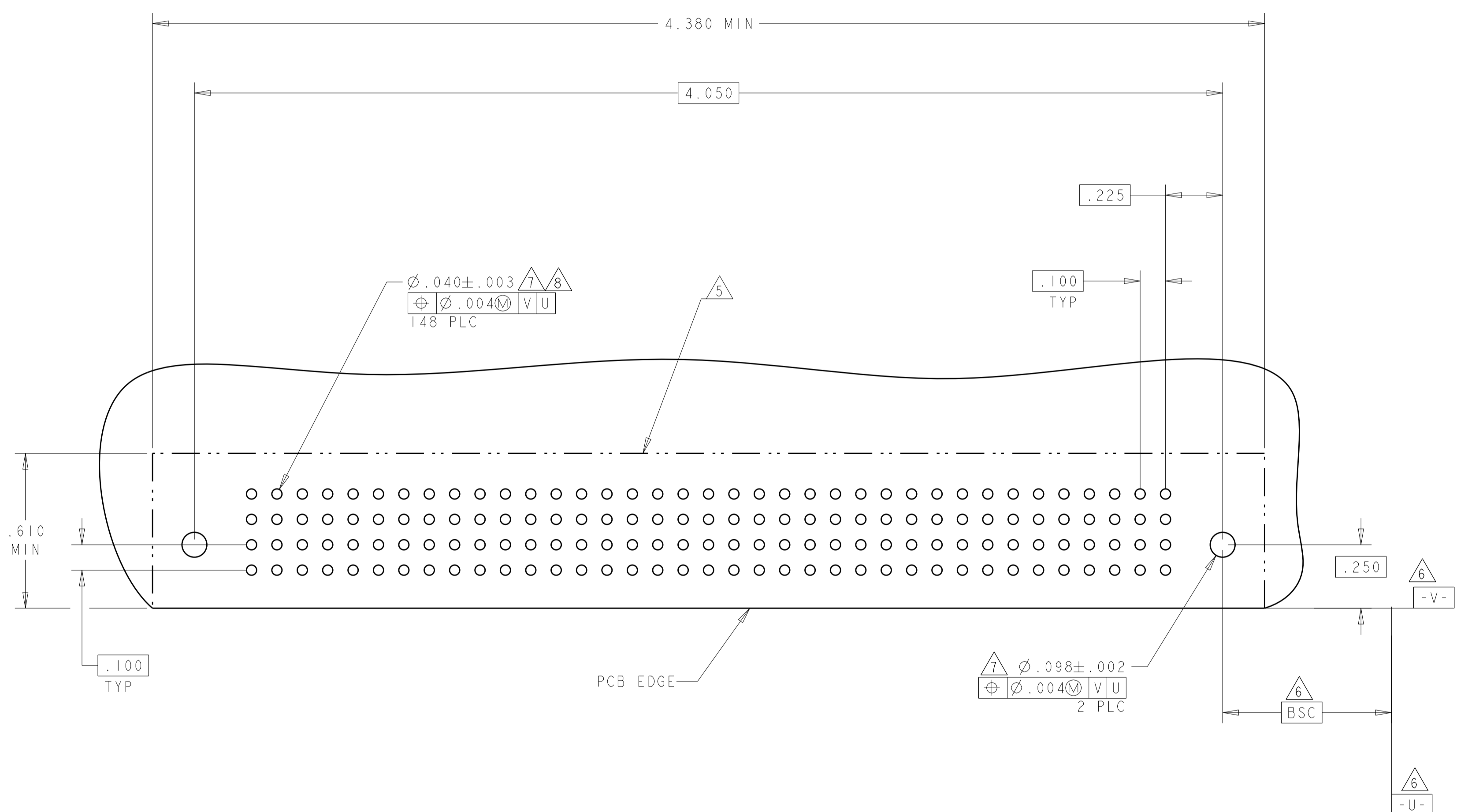
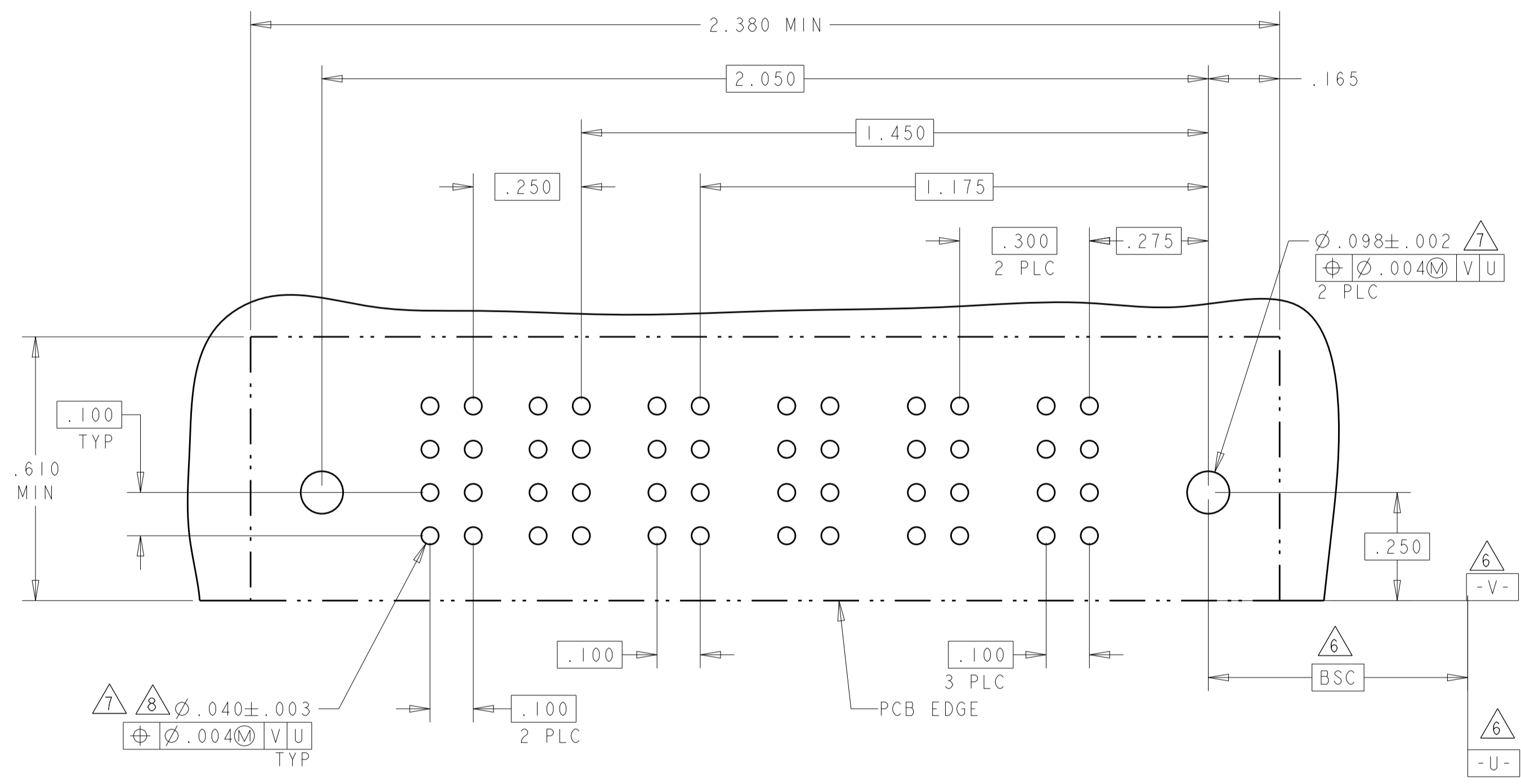

THIS DRAWING IS A CONTROLLED DOCUMENT.

DIMENSIONS:	TOLERANCES UNLESS OTHERWISE SPECIFIED:	DMN: R. GRZYBOWSKI 21FEB05	CHK: M. PERCHERKE 21FEB05	APVD: M. PERCHERKE 21FEB05	NAME: RIGHT ANGLE RECEPTACLE ASSEMBLY WITH GUIDES MULTI-BEAM XL
INCHES	0 PLC ± .01 2 PLC ± .01 3 PLC ± .01 4 PLC ± .005 ANGLES ± .002	PRODUCT SPEC: 108-1973	APPLICATION SPEC: 114-13038	WEIGHT: -	SIZE: A100779
MATERIAL:	FINISH: #2	Customer Drawing	SCALE: 3:1	SHEET: 15 OF 16	REV: G1

STC TE Connectivity

LOC	DIST	REVISIONS			
P	LTN	DESCRIPTION	DATE	DMN	APVD
-	-	SEE SHEET 1	-	-	-

PART NUMBER	ROWS	SIGNAL										POWER									
		P6	I1	I0	9	8	7	6	5	4	3	2	1	P5	P4	P3	P2	P1			
4-6450160-8	D C B A	H	H	H	H	H	H	H	H												
		G	G	G																	
		F	F																		
		E	E	E	E	E	E	E	E	E	E	E	E								
5P + 44S + IP		RM																			

PART NUMBER	ROWS	SIGNAL				
		4	3	2	1	
4-6450160-9	D	H	H	H	H	
	C	G	G	G	G	
	B	F	F	F	F	
	A	E	E	E	E	
16S		HD				HD

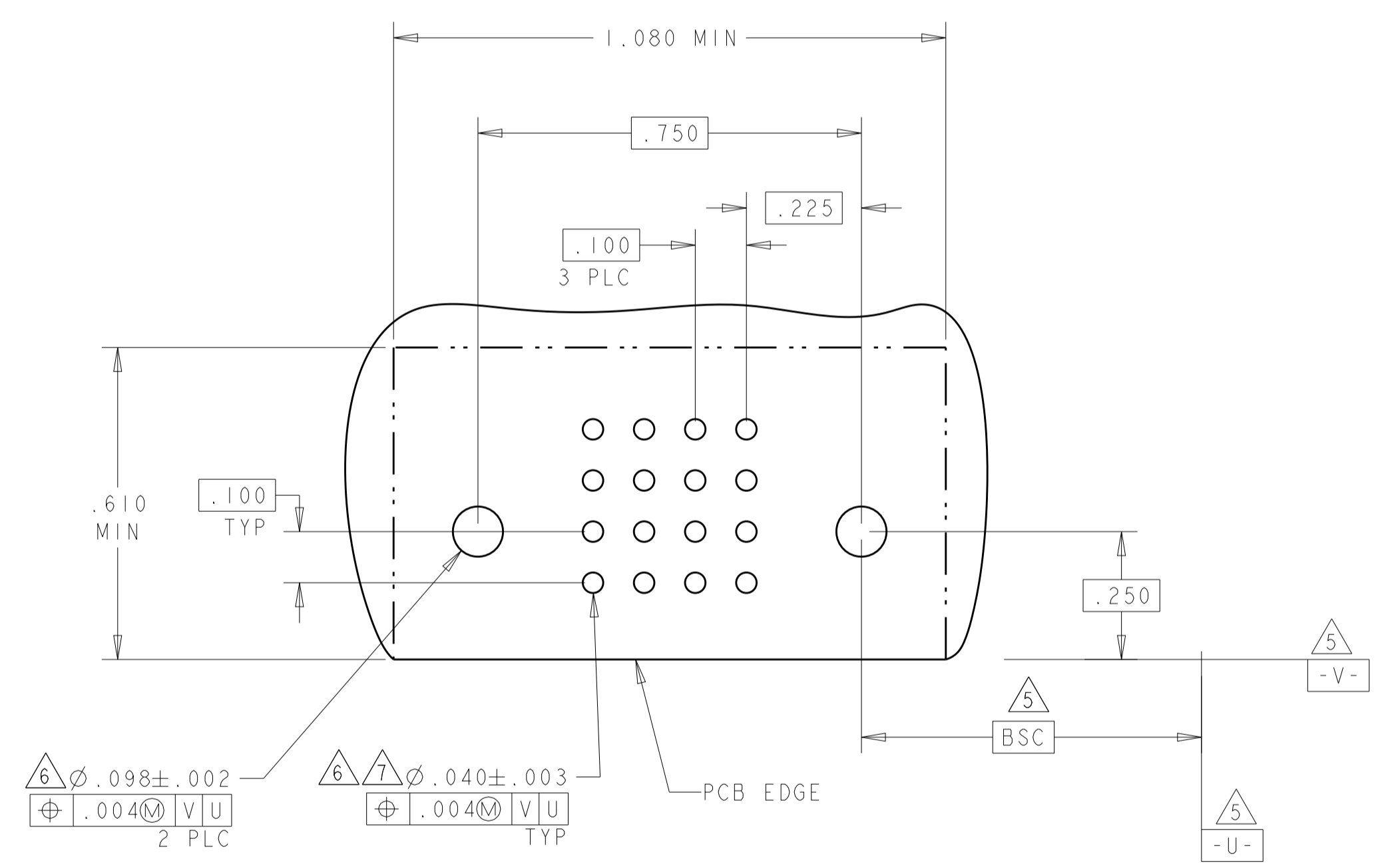
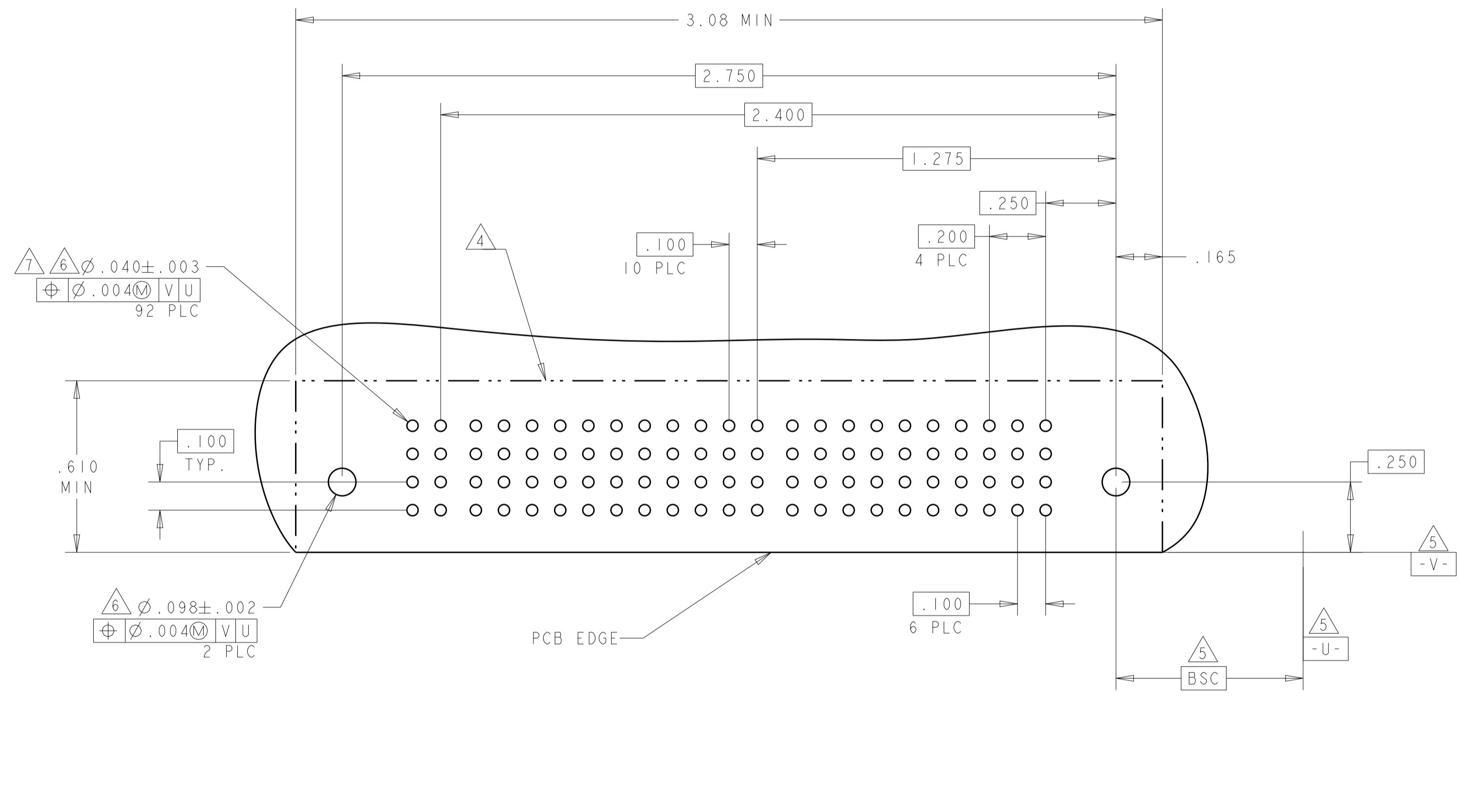

THIS DRAWING IS A CONTROLLED DOCUMENT.

DIMENSIONS:	TOLERANCES UNLESS OTHERWISE SPECIFIED:	DMN: R. GRZYBOWSKI 21FEB05	CHK: M. PERCHERKE 21FEB05	APVD: M. PERCHERKE 21FEB05	NAME: RIGHT ANGLE RECEPTACLE ASSEMBLY WITH GUIDES MULTI-BEAM XL
INCHES	0 PLC ± 1 PLC ±.01 2 PLC ±.01 3 PLC ±.005 4 PLC ±.002	PRODUCT SPEC: 108-1973	APPLICATION SPEC: 114-13038	SIZE: 114-13038	RESTRICTED TO: -
MATERIAL:	FINISH: #2	WEIGHT: -	Customer Drawing	SCALE: 3:1	SHEET 16 OF 16

4805 (3/11)



Компания «ЭлектроПласт» предлагает заключение долгосрочных отношений при поставках импортных электронных компонентов на взаимовыгодных условиях!

Наши преимущества:

- Оперативные поставки широкого спектра электронных компонентов отечественного и импортного производства напрямую от производителей и с крупнейших мировых складов;
- Поставка более 17-ти миллионов наименований электронных компонентов;
- Поставка сложных, дефицитных, либо снятых с производства позиций;
- Оперативные сроки поставки под заказ (от 5 рабочих дней);
- Экспресс доставка в любую точку России;
- Техническая поддержка проекта, помощь в подборе аналогов, поставка прототипов;
- Система менеджмента качества сертифицирована по Международному стандарту ISO 9001;
- Лицензия ФСБ на осуществление работ с использованием сведений, составляющих государственную тайну;
- Поставка специализированных компонентов (Xilinx, Altera, Analog Devices, Intersil, Interpoint, Microsemi, Aeroflex, Peregrine, Syfer, Eurofarad, Texas Instrument, Miteq, Cobham, E2V, MA-COM, Hittite, Mini-Circuits, General Dynamics и др.);

Помимо этого, одним из направлений компании «ЭлектроПласт» является направление «Источники питания». Мы предлагаем Вам помощь Конструкторского отдела:

- Подбор оптимального решения, техническое обоснование при выборе компонента;
- Подбор аналогов;
- Консультации по применению компонента;
- Поставка образцов и прототипов;
- Техническая поддержка проекта;
- Защита от снятия компонента с производства.



Как с нами связаться

Телефон: 8 (812) 309 58 32 (многоканальный)

Факс: 8 (812) 320-02-42

Электронная почта: org@eplast1.ru

Адрес: 198099, г. Санкт-Петербург, ул. Калинина, дом 2, корпус 4, литера А.