

LM4040

Improved Precision Micropower Shunt Voltage Reference with Multiple Reverse Breakdown Voltages

General Description

The LM4040 is a precision, two-terminal shunt mode, bandgap voltage reference available in fixed reverse-breakdown voltages of 2.048V, 2.500V, 3.000V, 3.3V, 4.096V, and 5.000V. Ideal for space-critical applications, the LM4040 is offered in the subminiature 3-pin SC70 surface-mount package (1.8mm x 1.8mm), 50% smaller than comparable devices in SOT23 surface-mount packages (SOT23 versions are also available).

Laser-trimmed resistors ensure precise initial accuracy. With a 100ppm/°C temperature coefficient, the device is offered in four grades of initial accuracy ranging from 0.1% to 1%. The LM4040 has a 60µA to 15mA shunt current capability with low dynamic impedance, ensuring stable reverse breakdown voltage accuracy over a wide range of operating temperatures and currents.

The LM4040 does not require an external stabilizing capacitor while ensuring stability with any capacitive load.

The LM4040 is guaranteed over the temperature range of -40°C to +125°C.

For a 1.225V output version, refer to the LM4041 data sheet.

Applications

- Portable, Battery-Powered Equipment
- Notebook Computers
- Cell Phones
- Industrial Process Controls
- Automotive

Benefits and Features

- Ultra-Small 3-Pin SC70 Package
- 0.1% (max) Initial Accuracy
- 100ppm/°C (max) Temperature Coefficient
Guaranteed Over -40°C to +125°C Temperature Range
- Wide Operating Current Range: 60µA to 15mA
- Low 28µV_{RMS} Output Noise (10Hz to 10kHz)
- 2.048V, 2.500V, 3.000V, 3.3V, 4.096V, and 5.000V Fixed Reverse-Breakdown Voltages
- No Output Capacitors Required
- Tolerates Capacitive Loads
- AEC-Q100 Qualified - Refer to [Ordering Information](#) table for *I*/*V* parts

[Ordering Information](#) appears at end of data sheet.

LM4040

Improved Precision Micropower Shunt Voltage Reference with Multiple Reverse Breakdown Voltages

Absolute Maximum Ratings

| | | | |
|---|---------|---|-----------------|
| Reverse Current (cathode to anode)..... | 20mA | Operating Temperature Range | |
| Forward Current (anode to cathode)..... | 10mA | LM4040_I_ _ _ | -40°C to +85°C |
| Continuous Power Dissipation (T _A = +70°C) | | LM4040_E_ _ _ | -40°C to +125°C |
| 3-Pin SC70 (derate 2.90mW/°C above +70°C)..... | 235mW | Storage Temperature Range | -65°C to +150°C |
| 3-Pin SOT23 (derate 3mW/°C above +70°C) | 238.1mW | Junction Temperature | +150°C |
| | | Lead Temperature (soldering, 10s) | +300°C |
| | | Soldering Temperature (reflow) | +260°C |

Stresses beyond those listed under "Absolute Maximum Ratings" may cause permanent damage to the device. These are stress ratings only, and functional operation of the device at these or any other conditions beyond those indicated in the operational sections of the specifications is not implied. Exposure to absolute maximum rating conditions for extended periods may affect device reliability.

Package Information

3 SOT23

| PACKAGE CODE | U3+1 |
|--|-------------------------|
| Outline Number | 21-0051 |
| Land Pattern Number | 90-0179 |
| Thermal Resistance, Single-Layer Board: | |
| Junction to Ambient (θ _{JA}) | N/A |
| Junction to Case (θ _{JC}) | N/A |
| Thermal Resistance, Four-Layer Board: | |
| Junction to Ambient (θ _{JA}) | 336°C/W |
| Junction to Case (θ _{JC}) | 110.10°C/W |

3 SC70

| PACKAGE CODE | X3+2 |
|--|-------------------------|
| Outline Number | 21-0075 |
| Land Pattern Number | 90-0208 |
| Thermal Resistance, Single-Layer Board: | |
| Junction to Ambient (θ _{JA}) | 340°C/W |
| Junction to Case (θ _{JC}) | 115°C/W |
| Thermal Resistance, Four-Layer Board: | |
| Junction to Ambient (θ _{JA}) | 340.40°C/W |
| Junction to Case (θ _{JC}) | 120°C/W |

For the latest package outline information and land patterns (footprints), go to www.maximintegrated.com/packages. Note that a "+", "#", or "-" in the package code indicates RoHS status only. Package drawings may show a different suffix character, but the drawing pertains to the package regardless of RoHS status.

Package thermal resistances were obtained using the method described in JEDEC specification JESD51-7, using a four-layer board. For detailed information on package thermal considerations, refer to www.maximintegrated.com/thermal-tutorial.

LM4040

Improved Precision Micropower Shunt Voltage
Reference with Multiple Reverse Breakdown Voltages

Electrical Characteristics—2.048V

(I_R = 100μA, T_A = T_{MIN} to T_{MAX}, unless otherwise noted. Typical values are at T_A = +25°C.) (Note 1)

| PARAMETER | SYMBOL | CONDITIONS | | MIN | TYP | MAX | UNITS |
|---|---------------------|---|----------------|-------|-------|-------------------|-------|
| Reverse Breakdown Voltage | V _R | T _A = +25°C | LM4040A (0.1%) | 2.046 | 2.048 | 2.050 | V |
| | | | LM4040B (0.2%) | 2.044 | 2.048 | 2.052 | |
| | | | LM4040C (0.5%) | 2.038 | 2.048 | 2.058 | |
| | | | LM4040D (1.0%) | 2.028 | 2.048 | 2.068 | |
| Reverse Breakdown Voltage Tolerance (Note 2) | V _R | LM4040A | | ±2.0 | ±15 | mV | |
| | | LM4040B | | ±4.0 | ±17 | | |
| | | LM4040C | | ±10 | ±23 | | |
| | | LM4040D | | ±20 | ±41 | | |
| Minimum Operating Current | I _{RMIN} | LM4040A/B/C | | 45 | 65 | μA | |
| | | LM4040D | | 45 | 70 | | |
| Average Reverse Voltage Temperature Coefficient (Notes 2 and 3) | ΔV _R /ΔT | I _R = 10mA | | ±20 | | ppm/°C | |
| | | I _R = 1mA | LM4040A/B/C | ±15 | ±100 | | |
| | | | LM4040D | ±15 | ±150 | | |
| I _R = 100μA | | ±15 | | | | | |
| Reverse Breakdown Voltage Change with Operating Current Change | | I _{RMIN} ≤ I _R ≤ 1mA | LM4040A/B/C | 0.3 | 1.0 | mV | |
| | | | LM4040D | 0.3 | 1.2 | | |
| | | 1mA ≤ I _R ≤ 15mA | LM4040A/B/C | 2.5 | 8.0 | | |
| | | | LM4040D | 2.5 | 10.0 | | |
| Reverse Dynamic Impedance (Note 3) | Z _R | I _R = 1mA, f = 120Hz, I _{AC} = 0.1I _R | LM4040A/B | 0.3 | 0.8 | Ω | |
| | | | LM4040C | 0.3 | 0.9 | | |
| | | | LM4040D | 0.3 | 1.1 | | |
| Wideband Noise | e _N | I _R = 100μA, 10Hz ≤ f ≤ 10kHz | | 28 | | μV _{RMS} | |
| Reverse Breakdown Voltage Long-Term Stability | ΔV _R | T = 1000h | | 120 | | ppm | |

LM4040

Improved Precision Micropower Shunt Voltage Reference with Multiple Reverse Breakdown Voltages

Electrical Characteristics—2.500V

($I_R = 100\mu\text{A}$, $T_A = T_{\text{MIN}}$ to T_{MAX} , unless otherwise noted. Typical values are at $T_A = +25^\circ\text{C}$.) (Note 1)

| PARAMETER | SYMBOL | CONDITIONS | | MIN | TYP | MAX | UNITS |
|---|-----------------------|---|----------------|-----------|-----------|----------------------------|-------|
| Reverse Breakdown Voltage | V_R | $T_A = +25^\circ\text{C}$ | LM4040A (0.1%) | 2.4975 | 2.5000 | 2.5025 | V |
| | | | LM4040B (0.2%) | 2.4950 | 2.5000 | 2.5050 | |
| | | | LM4040C (0.5%) | 2.4875 | 2.5000 | 2.5125 | |
| | | | LM4040D (1.0%) | 2.4750 | 2.5000 | 2.5250 | |
| Reverse Breakdown Voltage Tolerance (Note 2) | V_R | LM4040A | | ± 2.0 | ± 19 | mV | |
| | | LM4040B | | ± 4.0 | ± 21 | | |
| | | LM4040C | | ± 10 | ± 29 | | |
| | | LM4040D | | ± 20 | ± 49 | | |
| Minimum Operating Current | $I_{R\text{MIN}}$ | LM4040A/B/C | | 45 | 65 | μA | |
| | | LM4040D | | 45 | 70 | | |
| Average Reverse Voltage Temperature Coefficient (Notes 2 and 3) | $\Delta V_R/\Delta T$ | $I_R = 10\text{mA}$ | | ± 20 | | ppm/ $^\circ\text{C}$ | |
| | | $I_R = 1\text{mA}$ | LM4040A/B/C | ± 15 | ± 100 | | |
| | | | LM4040D | ± 15 | ± 150 | | |
| Reverse Breakdown Voltage Change with Operating Current Change | | $I_{R\text{MIN}} \leq I_R \leq 1\text{mA}$ | LM4040A/B/C | 0.3 | 1.0 | mV | |
| | | | LM4040D | 0.4 | 1.2 | | |
| | | $1\text{mA} \leq I_R \leq 15\text{mA}$ | LM4040A/B/C | 2.5 | 8.0 | | |
| | | | LM4040D | 2.5 | 10.0 | | |
| Reverse Dynamic Impedance (Note 3) | Z_R | $I_R = 1\text{mA}$, $f = 120\text{Hz}$, $I_{AC} = 0.1I_R$ | LM4040A/B | 0.3 | 0.8 | Ω | |
| | | | LM4040C | 0.3 | 0.9 | | |
| | | | LM4040D | 0.3 | 1.1 | | |
| Wideband Noise | e_N | $I_R = 100\mu\text{A}$, $10\text{Hz} \leq f \leq 10\text{kHz}$ | | 35 | | μV_{RMS} | |
| Reverse Breakdown Voltage Long-Term Stability | ΔV_R | $T = 1000\text{h}$ | | 120 | | ppm | |

LM4040

Improved Precision Micropower Shunt Voltage Reference with Multiple Reverse Breakdown Voltages

Electrical Characteristics—3.000V

($I_R = 100\mu\text{A}$, $T_A = T_{\text{MIN}}$ to T_{MAX} , unless otherwise noted. Typical values are at $T_A = +25^\circ\text{C}$.) (Note 1)

| PARAMETER | SYMBOL | CONDITIONS | | MIN | TYP | MAX | UNITS |
|---|-----------------------|---|----------------|-----------|-----------|----------------------------|-------|
| Reverse Breakdown Voltage | V_R | $T_A = +25^\circ\text{C}$ | LM4040A (0.1%) | 2.997 | 3.000 | 3.003 | V |
| | | | LM4040B (0.2%) | 2.994 | 3.000 | 3.006 | |
| | | | LM4040C (0.5%) | 2.985 | 3.000 | 3.015 | |
| | | | LM4040D (1.0%) | 2.970 | 3.000 | 3.030 | |
| Reverse Breakdown Voltage Tolerance (Note 2) | V_R | LM4040A | | ± 3.0 | ± 22 | mV | |
| | | LM4040B | | ± 6.0 | ± 26 | | |
| | | LM4040C | | ± 15 | ± 34 | | |
| | | LM4040D | | ± 30 | ± 59 | | |
| Minimum Operating Current | I_{RMIN} | LM4040A/B/C | | 45 | 67 | μA | |
| | | LM4040D | | 45 | 70 | | |
| Average Reverse Voltage Temperature Coefficient (Notes 2 and 3) | $\Delta V_R/\Delta T$ | $I_R = 10\text{mA}$ | | ± 20 | | ppm/ $^\circ\text{C}$ | |
| | | $I_R = 1\text{mA}$ | LM4040A/B/C | ± 15 | ± 100 | | |
| | | | LM4040D | ± 15 | ± 150 | | |
| Reverse Breakdown Voltage Change with Operating Current Change | | $I_{\text{RMIN}} \leq I_R \leq 1\text{mA}$ | LM4040A/B/C | 0.3 | 1.0 | mV | |
| | | | LM4040D | 0.3 | 1.2 | | |
| | | $1\text{mA} \leq I_R \leq 15\text{mA}$ | LM4040A/B/C | 2.5 | 8.0 | | |
| | | | LM4040D | 2.5 | 10.0 | | |
| Reverse Dynamic Impedance (Note 3) | Z_R | $I_R = 1\text{mA}$, $f = 120\text{Hz}$, $I_{\text{AC}} = 0.1I_R$ | LM4040A/B | 0.3 | 0.8 | Ω | |
| | | | LM4040C | 0.3 | 0.9 | | |
| | | | LM4040D | 0.3 | 1.1 | | |
| Wideband Noise | e_N | $I_R = 100\mu\text{A}$, $10\text{Hz} \leq f \leq 10\text{kHz}$ | | 45 | | μV_{RMS} | |
| Reverse Breakdown Voltage Long-Term Stability | ΔV_R | $T = 1000\text{h}$ | | 120 | | ppm | |

Electrical Characteristics—3.300V

(I_R = 100μA, T_A = T_{MIN} to T_{MAX}, unless otherwise noted. Typical values are at T_A = +25°C.) (Note 1)

| PARAMETER | SYMBOL | CONDITIONS | | MIN | TYP | MAX | UNITS |
|---|---------------------|---|----------------|--------|--------|--------|-------------------|
| Reverse Breakdown Voltage | V _R | T _A = +25°C | LM4040A (0.1%) | 3.2967 | 3.3000 | 3.3033 | V |
| | | | LM4040B (0.2%) | 3.2934 | 3.3000 | 3.3066 | |
| | | | LM4040C (0.5%) | 3.2835 | 3.3000 | 3.3165 | |
| | | | LM4040D (1.0%) | 3.2670 | 3.3000 | 3.3330 | |
| Reverse Breakdown Voltage Tolerance (Note 2) | V _R | LM4040A | | ±3.0 | | ±22 | mV |
| | | LM4040B | | ±6.0 | | ±26 | |
| | | LM4040C | | ±15 | | ±34 | |
| | | LM4040D | | ±30 | | ±59 | |
| Minimum Operating Current | I _{RMIN} | LM4040A/B/C | | 45 | | 67 | μA |
| | | LM4040D | | 45 | | 70 | |
| Average Reverse Voltage Temperature Coefficient (Notes 2 and 3) | ΔV _R /ΔT | I _R = 10mA | | ±20 | | | ppm/°C |
| | | I _R = 1mA | LM4040A/B/C | ±15 | | ±100 | |
| | | | LM4040D | ±15 | | ±150 | |
| Reverse Breakdown Voltage Change with Operating Current Change | | I _{RMIN} ≤ I _R ≤ 1mA | LM4040A/B/C | 0.3 | | 1.0 | mV |
| | | | LM4040D | 0.3 | | 1.2 | |
| | | 1mA ≤ I _R ≤ 15mA | LM4040A/B/C | 2.5 | | 8.0 | |
| | | | LM4040D | 2.5 | | 10.0 | |
| Reverse Dynamic Impedance (Note 3) | Z _R | I _R = 1mA, f = 120Hz, I _{AC} = 0.1I _R | LM4040A/B | 0.3 | | 0.8 | Ω |
| | | | LM4040C | 0.3 | | 0.9 | |
| | | | LM4040D | 0.3 | | 1.1 | |
| Wideband Noise | e _N | I _R = 100μA, 10Hz ≤ f ≤ 10kHz | | 50 | | | μV _{RMS} |
| Reverse Breakdown Voltage Long-Term Stability | ΔV _R | T = 1000h | | 120 | | | ppm |

LM4040

Improved Precision Micropower Shunt Voltage Reference with Multiple Reverse Breakdown Voltages

Electrical Characteristics—4.096V

($I_R = 100\mu\text{A}$, $T_A = T_{\text{MIN}}$ to T_{MAX} , unless otherwise noted. Typical values are at $T_A = +25^\circ\text{C}$.) (Note 1)

| PARAMETER | SYMBOL | CONDITIONS | | MIN | TYP | MAX | UNITS |
|---|-----------------------|---|----------------|-----------|-----------|----------------------------|-------|
| Reverse Breakdown Voltage | V_R | $T_A = +25^\circ\text{C}$ | LM4040A (0.1%) | 4.092 | 4.096 | 4.100 | V |
| | | | LM4040B (0.2%) | 4.088 | 4.096 | 4.104 | |
| | | | LM4040C (0.5%) | 4.076 | 4.096 | 4.116 | |
| | | | LM4040D (1.0%) | 4.055 | 4.096 | 4.137 | |
| Reverse Breakdown Voltage Tolerance (Note 2) | V_R | LM4040A | | ± 4.1 | ± 31 | mV | |
| | | LM4040B | | ± 8.2 | ± 35 | | |
| | | LM4040C | | ± 20 | ± 47 | | |
| | | LM4040D | | ± 41 | ± 81 | | |
| Minimum Operating Current | I_{RMIN} | LM4040A/B/C | | 50 | 73 | μA | |
| | | LM4040D | | 50 | 78 | | |
| Average Reverse Voltage Temperature Coefficient (Notes 2 and 3) | $\Delta V_R/\Delta T$ | $I_R = 10\text{mA}$ | | ± 30 | | ppm/ $^\circ\text{C}$ | |
| | | $I_R = 1\text{mA}$ | LM4040A/B/C | ± 20 | ± 100 | | |
| | | | LM4040D | ± 20 | ± 150 | | |
| Reverse Breakdown Voltage Change with Operating Current Change | | $I_{\text{RMIN}} \leq I_R \leq 1\text{mA}$ | LM4040A/B/C | 0.5 | 1.2 | mV | |
| | | | LM4040D | 0.5 | 1.5 | | |
| | | $1\text{mA} \leq I_R \leq 15\text{mA}$ | LM4040A/B/C | 3.0 | 10.0 | | |
| | | | LM4040D | 3.0 | 13.0 | | |
| Reverse Dynamic Impedance (Note 3) | Z_R | $I_R = 1\text{mA}$, $f = 120\text{Hz}$, $I_{\text{AC}} = 0.1I_R$ | LM4040A/B/C | 0.5 | 1.0 | Ω | |
| | | | LM4040D | 0.5 | 1.3 | | |
| Wideband Noise | e_N | $I_R = 100\mu\text{A}$, $10\text{Hz} \leq f \leq 10\text{kHz}$ | | 64 | | μV_{RMS} | |
| Reverse Breakdown Voltage Long-Term Stability | ΔV_R | $T = 1000\text{h}$ | | 120 | | ppm | |

LM4040

Improved Precision Micropower Shunt Voltage Reference with Multiple Reverse Breakdown Voltages

Electrical Characteristics—5.000V

($I_R = 100\mu\text{A}$, $T_A = T_{\text{MIN}}$ to T_{MAX} , unless otherwise noted. Typical values are at $T_A = +25^\circ\text{C}$.) (Note 1)

| PARAMETER | SYMBOL | CONDITIONS | | MIN | TYP | MAX | UNITS |
|---|-----------------------|---|----------------|-----------|-----------|----------------------------|-------|
| Reverse Breakdown Voltage | V_R | $T_A = +25^\circ\text{C}$ | LM4040A (0.1%) | 4.995 | 5.000 | 5.005 | V |
| | | | LM4040B (0.2%) | 4.990 | 5.000 | 5.010 | |
| | | | LM4040C (0.5%) | 4.975 | 5.000 | 5.025 | |
| | | | LM4040D (1.0%) | 4.950 | 5.000 | 5.050 | |
| Reverse Breakdown Voltage Tolerance (Note 2) | V_R | LM4040A | | ± 5.0 | ± 38 | mV | |
| | | LM4040B | | ± 10 | ± 43 | | |
| | | LM4040C | | ± 25 | ± 58 | | |
| | | LM4040D | | ± 50 | ± 99 | | |
| Minimum Operating Current | I_{RMIN} | LM4040A/B/C | | 54 | 80 | μA | |
| | | LM4040D | | 54 | 85 | | |
| Average Reverse Voltage Temperature Coefficient (Notes 2 and 3) | $\Delta V_R/\Delta T$ | $I_R = 10\text{mA}$ | | ± 30 | | ppm/ $^\circ\text{C}$ | |
| | | $I_R = 1\text{mA}$ | LM4040A/B/C | ± 20 | ± 100 | | |
| | | | LM4040D | ± 20 | ± 150 | | |
| Reverse Breakdown Voltage Change with Operating Current Change | | $I_{\text{RMIN}} \leq I_R \leq 1\text{mA}$ | LM4040A/B/C | 0.5 | 1.4 | mV | |
| | | | LM4040D | 0.5 | 1.8 | | |
| | | $1\text{mA} \leq I_R \leq 15\text{mA}$ | LM4040A/B/C | 3.5 | 12.0 | | |
| | | | LM4040D | 3.5 | 15.0 | | |
| Reverse Dynamic Impedance (Note 3) | Z_R | $I_R = 1\text{mA}$, $f = 120\text{Hz}$, $I_{\text{AC}} = 0.1I_R$ | LM4040A/B/C | 0.5 | 1.1 | Ω | |
| | | | LM4040D | 0.5 | 1.5 | | |
| Wideband Noise | e_N | $I_R = 100\mu\text{A}$, $10\text{Hz} \leq f \leq 10\text{kHz}$ | | 80 | | μV_{RMS} | |
| Reverse Breakdown Voltage Long-Term Stability | ΔV_R | $T = 1000\text{h}$ | | 120 | | ppm | |

Note 1: All devices are 100% production tested at $T_A = +25^\circ\text{C}$ and are guaranteed by design for $T_A = T_{\text{MIN}}$ to T_{MAX} , as specified.

Note 2: The overtemperature limit for Reverse Breakdown Voltage Tolerance is defined as the room-temperature Reverse Breakdown Voltage Tolerance $\pm[(\Delta V_R/\Delta T)(\text{max}\Delta T)(V_R)]$, where $\Delta V_R/\Delta T$ is the V_R temperature coefficient, $\text{max}\Delta T$ is the maximum difference in temperature from the reference point of $+25^\circ\text{C}$ to T_{MIN} or T_{MAX} , and V_R is the reverse breakdown voltage. The total overtemperature tolerance for the different grades in the temperature range where $\text{max}\Delta T = +65^\circ\text{C}$ is shown below:

A grade: $\pm 0.75\% = \pm 0.1\% \pm 100\text{ppm}/^\circ\text{C} \times 65^\circ\text{C}$

B grade: $\pm 0.85\% = \pm 0.2\% \pm 100\text{ppm}/^\circ\text{C} \times 65^\circ\text{C}$

C grade: $\pm 1.15\% = \pm 0.5\% \pm 100\text{ppm}/^\circ\text{C} \times 65^\circ\text{C}$

D grade: $\pm 1.98\% = \pm 1.0\% \pm 150\text{ppm}/^\circ\text{C} \times 65^\circ\text{C}$

The total over-temperature tolerance for the different grades in the extended temperature range where $\text{max}\Delta T = +100^\circ\text{C}$ is shown below:

A grade: $\pm 1.1\% = \pm 0.1\% \pm 100\text{ppm}/^\circ\text{C} \times 100^\circ\text{C}$

B grade: $\pm 1.2\% = \pm 0.2\% \pm 100\text{ppm}/^\circ\text{C} \times 100^\circ\text{C}$

C grade: $\pm 1.5\% = \pm 0.5\% \pm 100\text{ppm}/^\circ\text{C} \times 100^\circ\text{C}$

D grade: $\pm 2.5\% = \pm 1.0\% \pm 150\text{ppm}/^\circ\text{C} \times 100^\circ\text{C}$

Therefore, as an example, the A-grade LM4040-2.5 has an over-temperature reverse breakdown voltage tolerance of $\pm 2.5\text{V} \times 0.75\% = \pm 19\text{mV}$.

Note 3: Guaranteed by design.

Typical Operating Characteristics

($I_R = 100\mu A$, SC70-3 package, $T_A = +25^\circ C$, unless otherwise noted.)

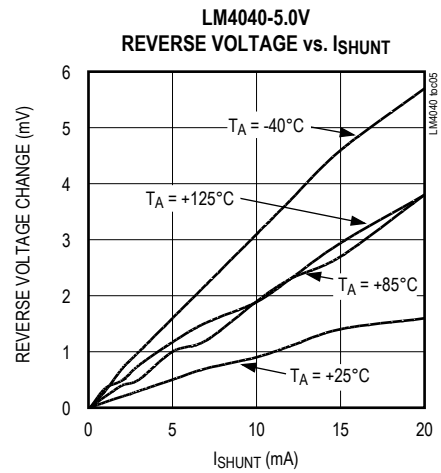
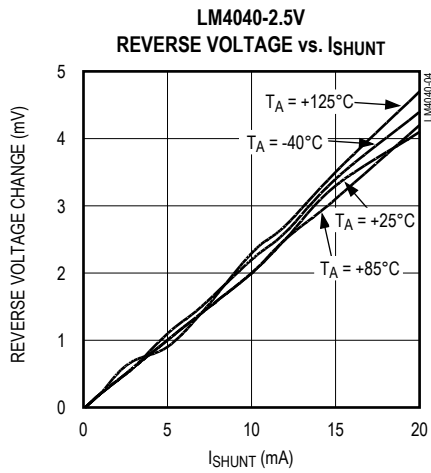

Typical Operating Characteristics (continued)

($I_R = 100\mu A$, SC70-3 package, $T_A = +25^\circ C$, unless otherwise noted.)

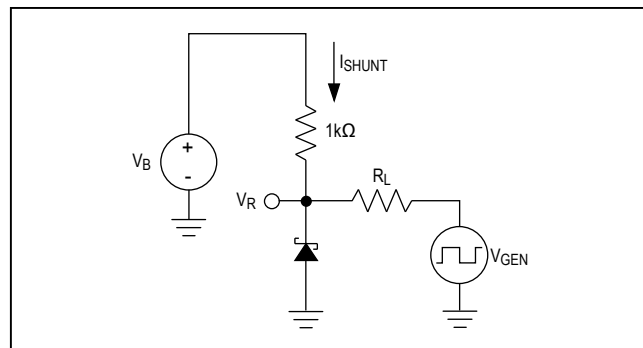
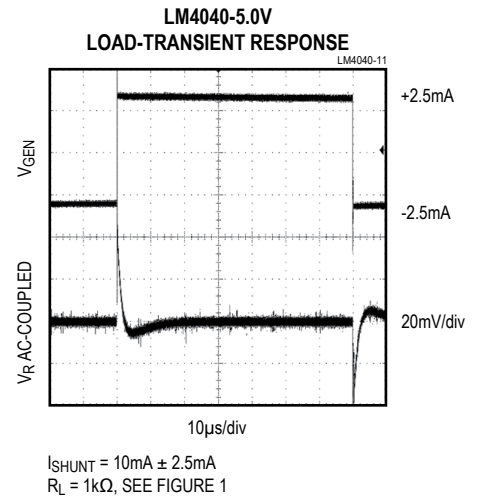
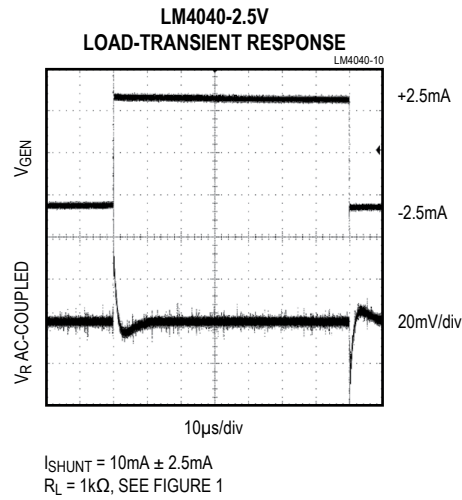
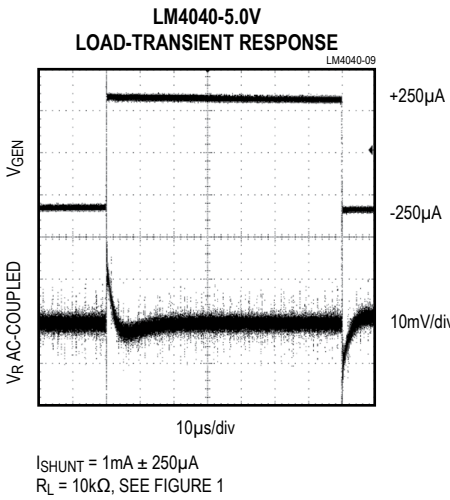
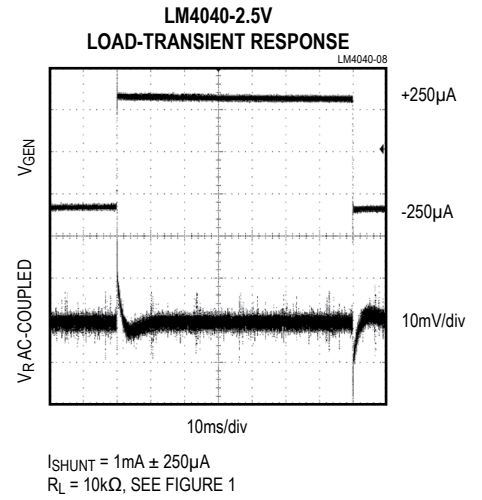
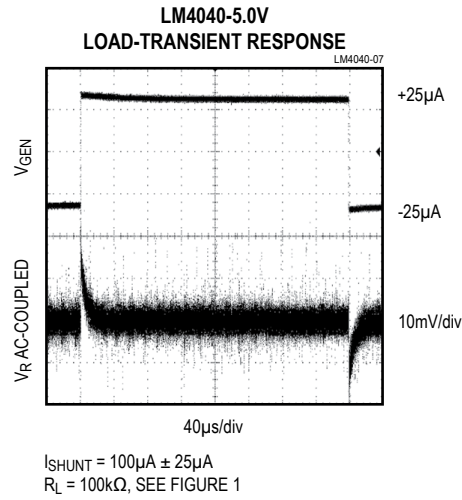
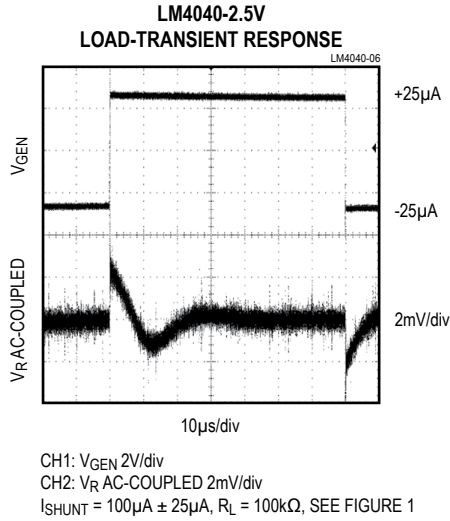

Figure 1. Load-Transient Test Circuit

Typical Operating Characteristics (continued)

($I_R = 100\mu A$, SC70-3 package, $T_A = +25^\circ C$, unless otherwise noted.)

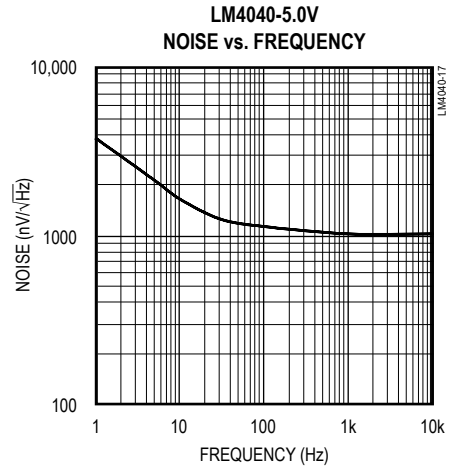
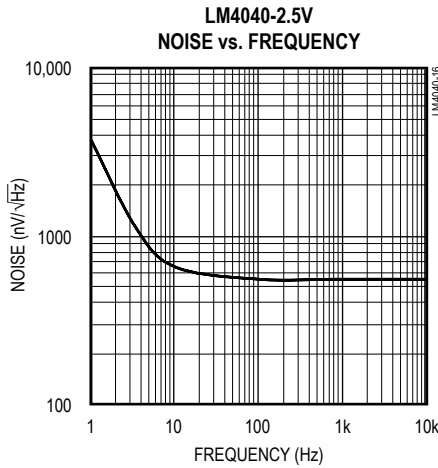
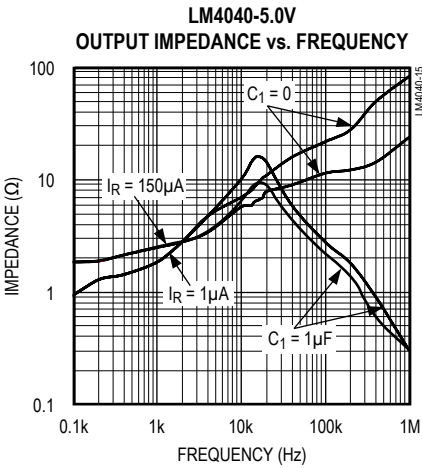
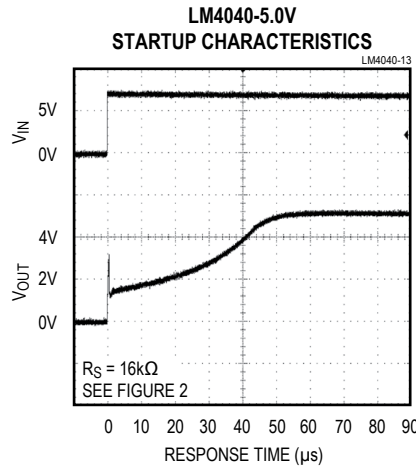

Figure 2. Startup Characteristics Test Circuit

LM4040

Improved Precision Micropower Shunt Voltage Reference with Multiple Reverse Breakdown Voltages

Pin Configuration



Pin Description

| PIN | NAME | FUNCTION |
|-----|------|--|
| 1 | + | Positive Terminal of the Shunt Reference |
| 2 | - | Negative Terminal of the Shunt Reference |
| 3 | N.C. | No connection. Leave this pin unconnected or connected to pin 2. |

Detailed Description

The LM4040 shunt references use the bandgap principle to produce a stable, accurate voltage. The device behaves similarly to an ideal zener diode; a fixed voltage is maintained across its output terminals when biased with 60µA to 15mA of reverse current. The LM4040 behaves similarly to a silicon diode when biased with forward currents up to 10mA.

Figure 3 shows a typical operating circuit. The LM4040 is ideal for providing a stable reference from a high-voltage power supply.

Applications Information

The device's internal pass transistor is used to maintain a constant output voltage (V_{SHUNT}) by sinking the necessary amount of current across a source resistor. The source resistance (R_S) is determined from the load current (I_{LOAD}) range, supply voltage (V_S) variations, V_{SHUNT} , and desired quiescent current.

Choose the value of R_S when V_S is at a minimum and I_{LOAD} is at a maximum. Maintain a minimum I_{SHUNT} of 60µA at all times. The R_S value should be large enough to keep I_{SHUNT} less than 15mA for proper regulation when V_S is maximum and I_{LOAD} is at a minimum. To prevent damage to the device, I_{SHUNT} should never exceed 20mA.

Therefore, the value of R_S is bounded by the following equation:

$$\frac{[V_{S(MIN)} - V_R]}{[60\mu A + I_{LOAD(MAX)}]} > R_S > \frac{[V_{S(MAX)} - V_R]}{[20mA + I_{LOAD(MIN)}]}$$

Choosing a larger resistance minimizes the total power dissipation in the circuit by reducing the shunt current ($P_{D(TOTAL)} = V_S \times I_{SHUNT}$). Provide a safety margin to incorporate the worst-case tolerance of the resistor used. Ensure that the resistor's power rating is adequate, using the following general power equation:

$$P_{DR} = I_{SHUNT} \times (V_{S(MAX)} - V_{SHUNT})$$

Output Capacitance

The device does not require an external capacitor for frequency stability and is stable for any output capacitance.



Figure 3. Typical Operating Circuit

Temperature Performance

The LM4040 typically exhibits an output voltage temperature coefficient within $\pm 15\text{ppm}/^\circ\text{C}$. The polarity of the temperature coefficient may be different from one device to another; some may have positive coefficients, and others may have negative coefficients.

High-Temperature Operation

The maximum junction temperature of the LM4040 is $+150^\circ\text{C}$. The maximum operating temperature for the LM4040_E_ is $+125^\circ\text{C}$. At a maximum load current of 15mA and a maximum output voltage of 5V, the part will dissipate 75mW of power. The power dissipation limits of the 3-pin SC70 call for a derating value of $2.17\text{mW}/^\circ\text{C}$ above $+70^\circ\text{C}$ and, therefore, for 75mW of power dissipation, the part will selfheat to 35.56°C above ambient temperature. If the ambient temperature is $+125^\circ\text{C}$, the part operates at 159.56°C , thereby exceeding the maximum junction temperature value of $+150^\circ\text{C}$. For high-temperature operation, care must be taken to ensure the combination of ambient temperature, output power dissipation and package thermal resistance does not conspire to raise the device temperature beyond that listed in the [Absolute Maximum Ratings](#). Either reduce the output load current or the ambient temperature to keep the part within the limits.

LM4040

Improved Precision Micropower Shunt Voltage
Reference with Multiple Reverse Breakdown Voltages

Ordering Information

| PART | OUTPUT VOLTAGE (V) | INITIAL ACCURACY (%) | TEMPCO (ppm/°C) | TEMP RANGE | PIN-PACKAGE | TOP MARK |
|---------------------|--------------------|----------------------|-----------------|-----------------|-------------|----------|
| LM4040AIM3-2.1+T | 2.048 | 0.1 | 100 | -40°C to +85°C | 3 SOT23 | FZEF |
| LM4040AIX3-2.1+T | 2.048 | 0.1 | 100 | -40°C to +85°C | 3 SC70 | ABJ |
| LM4040BIM3-2.1+T | 2.048 | 0.2 | 100 | -40°C to +85°C | 3 SOT23 | FZEG |
| LM4040BIX3-2.1+T | 2.048 | 0.2 | 100 | -40°C to +85°C | 3 SC70 | ABK |
| LM4040CIM3-2.1+T | 2.048 | 0.5 | 100 | -40°C to +85°C | 3 SOT23 | FZEH |
| LM4040CIX3-2.1+T | 2.048 | 0.5 | 100 | -40°C to +85°C | 3 SC70 | ABL |
| LM4040DIM3-2.1+T | 2.048 | 1.0 | 150 | -40°C to +85°C | 3 SOT23 | FZEI |
| LM4040DIX3-2.1+T | 2.048 | 1.0 | 150 | -40°C to +85°C | 3 SC70 | ABM |
| LM4040AEM3-2.1+T | 2.048 | 0.1 | 100 | -40°C to +125°C | 3 SOT23 | FZNG |
| LM4040AEX3-2.1+T | 2.048 | 0.1 | 100 | -40°C to +125°C | 3 SC70 | ALF |
| LM4040BEM3-2.1-T | 2.048 | 0.2 | 100 | -40°C to +125°C | 3 SOT23 | FZNH |
| LM4040BEX3-2.1-T | 2.048 | 0.2 | 100 | -40°C to +125°C | 3 SC70 | ALG |
| LM4040CEM3-2.1-T | 2.048 | 0.5 | 100 | -40°C to +125°C | 3 SOT23 | FZNI |
| LM4040CEX3-2.1+T | 2.048 | 0.5 | 100 | -40°C to +125°C | 3 SC70 | ALH |
| LM4040DEM3-2.1+T | 2.048 | 1.0 | 150 | -40°C to +125°C | 3 SOT23 | FZNJ |
| LM4040DEX3-2.1+T | 2.048 | 1.0 | 150 | -40°C to +125°C | 3 SC70 | ALI |
| LM4040AIM3-2.5+T | 2.500 | 0.1 | 100 | -40°C to +85°C | 3 SOT23 | FZEJ |
| LM4040AIX3-2.5+T | 2.500 | 0.1 | 100 | -40°C to +85°C | 3 SC70 | ABN |
| LM4040BIM3-2.5+T | 2.500 | 0.2 | 100 | -40°C to +85°C | 3 SOT23 | FZEK |
| LM4040BIX3-2.5+T | 2.500 | 0.2 | 100 | -40°C to +85°C | 3 SC70 | ABO |
| LM4040BIM3-2.5/V+T | 2.500 | 0.2 | 100 | -40°C to +125°C | 3 SOT23 | FZWL |
| LM4040CIM3-2.5+T | 2.500 | 0.5 | 100 | -40°C to +85°C | 3 SOT23 | FZEL |
| LM4040CIX3-2.5+T | 2.500 | 0.5 | 100 | -40°C to +85°C | 3 SC70 | ABP |
| LM4040DIM3-2.5+T | 2.500 | 1.0 | 150 | -40°C to +85°C | 3 SOT23 | FZEM |
| LM4040DIX3-2.5+T | 2.500 | 1.0 | 150 | -40°C to +85°C | 3 SC70 | ABQ |
| LM4040AEM3-2.5+T | 2.500 | 0.1 | 100 | -40°C to +125°C | 3 SOT23 | FZNK |
| LM4040AEX3-2.5+T | 2.500 | 0.1 | 100 | -40°C to +125°C | 3 SC70 | ALJ |
| LM4040BEM3-2.5+T | 2.500 | 0.2 | 100 | -40°C to +125°C | 3 SOT23 | FZNL |
| LM4040BEX3-2.5+T | 2.500 | 0.2 | 100 | -40°C to +125°C | 3 SC70 | ALK |
| LM4040CEM3-2.5+T | 2.500 | 0.5 | 100 | -40°C to +125°C | 3 SOT23 | FZNM |
| LM4040CEM3-2.5/V+T* | 2.500 | 0.5 | 100 | -40°C to +125°C | 3 SOT23 | FZVZ |
| LM4040CEX3-2.5+T | 2.500 | 0.5 | 100 | -40°C to +125°C | 3 SC70 | ALL |
| LM4040DEM3-2.5+T | 2.500 | 1.0 | 150 | -40°C to +125°C | 3 SOT23 | FZNN |
| LM4040DEX3-2.5+T | 2.500 | 1.0 | 150 | -40°C to +125°C | 3 SC70 | ALM |

+Denotes a lead(Pb)-free/RoHS-compliant package.

T = Tape and reel.

*Denotes future product—contact factory for availability.

LM4040

Improved Precision Micropower Shunt Voltage
Reference with Multiple Reverse Breakdown Voltages

Ordering Information (continued)

| PART | OUTPUT VOLTAGE (V) | INITIAL ACCURACY (%) | TEMPCO (ppm/°C) | TEMP RANGE | PIN-PACKAGE | TOP MARK |
|--------------------|--------------------|----------------------|-----------------|-----------------|-------------|----------|
| LM4040AIM3-3.0+T | 3.000 | 0.1 | 100 | -40°C to +85°C | 3 SOT23 | FZEN |
| LM4040AIX3-3.0+T | 3.000 | 0.1 | 100 | -40°C to +85°C | 3 SC70 | ABR |
| LM4040BIM3-3.0+T | 3.000 | 0.2 | 100 | -40°C to +85°C | 3 SOT23 | FZEO |
| LM4040BIX3-3.0+T | 3.000 | 0.2 | 100 | -40°C to +85°C | 3 SC70 | ABS |
| LM4040CIM3-3.0+T | 3.000 | 0.5 | 100 | -40°C to +85°C | 3 SOT23 | FZEP |
| LM4040CIX3-3.0+T | 3.000 | 0.5 | 100 | -40°C to +85°C | 3 SC70 | ABT |
| LM4040DIM3-3.0+T | 3.000 | 1.0 | 150 | -40°C to +85°C | 3 SOT23 | FZEQ |
| LM4040DIX3-3.0+T | 3.000 | 1.0 | 150 | -40°C to +85°C | 3 SC70 | ABU |
| LM4040AEM3-3.0+T | 3.000 | 0.1 | 100 | -40°C to +125°C | 3 SOT23 | FZNO |
| LM4040AEM3-3.0/V+T | 3.000 | 0.1 | 100 | -40°C to +125°C | 3 SOT23 | FZWW |
| LM4040AEX3-3.0+T | 3.000 | 0.1 | 100 | -40°C to +125°C | 3 SC70 | ALN |
| LM4040AEX3-3.0/V+T | 3.000 | 0.1 | 100 | -40°C to +125°C | 3 SC70 | ALN |
| LM4040BEM3-3.0+T | 3.000 | 0.2 | 100 | -40°C to +125°C | 3 SOT23 | FZNP |
| LM4040BEX3-3.0+T | 3.000 | 0.2 | 100 | -40°C to +125°C | 3 SC70 | ALO |
| LM4040CEX3-3.0+T | 3.000 | 0.5 | 100 | -40°C to +125°C | 3 SC70 | ALP |
| LM4040DEM3-3.0+T | 3.000 | 1.0 | 150 | -40°C to +125°C | 3 SOT23 | FZNR |
| LM4040DEX3-3.0+T | 3.000 | 1.0 | 150 | -40°C to +125°C | 3 SC70 | ALQ |
| LM4040AEX3-3.3+T | 3.300 | 0.1 | 100 | -40°C to +125°C | 3 SC70 | ANY |
| LM4040BEX3-3.3+T | 3.300 | 0.2 | 100 | -40°C to +125°C | 3 SC70 | ANZ |
| LM4040CEX3-3.3+T | 3.300 | 0.5 | 100 | -40°C to +125°C | 3 SC70 | AOA |
| LM4040DEX3-3.3+T | 3.300 | 1.0 | 150 | -40°C to +125°C | 3 SC70 | AOB |
| LM4040AIM3-4.1+T | 4.096 | 0.1 | 100 | -40°C to +85°C | 3 SOT23 | FZER |
| LM4040AIX3-4.1+T | 4.096 | 0.1 | 100 | -40°C to +85°C | 3 SC70 | ABV |
| LM4040BIM3-4.1+T | 4.096 | 0.2 | 100 | -40°C to +85°C | 3 SOT23 | FZES |
| LM4040BIX3-4.1+T | 4.096 | 0.2 | 100 | -40°C to +85°C | 3 SC70 | ABW |
| LM4040CIM3-4.1+T | 4.096 | 0.5 | 100 | -40°C to +85°C | 3 SOT23 | FZET |
| LM4040CIX3-4.1+T | 4.096 | 0.5 | 100 | -40°C to +85°C | 3 SC70 | ABX |
| LM4040DIM3-4.1+T | 4.096 | 1.0 | 150 | -40°C to +85°C | 3 SOT23 | FZEU |
| LM4040DIX3-4.1+T | 4.096 | 1.0 | 150 | -40°C to +85°C | 3 SC70 | ABY |
| LM4040AEM3-4.1+T | 4.096 | 0.1 | 100 | -40°C to +125°C | 3 SOT23 | FZNS |
| LM4040AEX3-4.1+T | 4.096 | 0.1 | 100 | -40°C to +125°C | 3 SC70 | ALR |
| LM4040BEM3-4.1+T | 4.096 | 0.2 | 100 | -40°C to +125°C | 3 SOT23 | FZNT |
| LM4040BEM3-4.1/V+T | 4.096 | 0.2 | 100 | -40°C to +125°C | 3 SOT23 | FZXX |
| LM4040BEX3-4.1+T | 4.096 | 0.2 | 100 | -40°C to +125°C | 3 SC70 | ALS |
| LM4040CEM3-4.1+T | 4.096 | 0.5 | 100 | -40°C to +125°C | 3 SOT23 | FZNU |

+Denotes a lead(Pb)-free/RoHS-compliant package.

T = Tape and reel.

LM4040

Improved Precision Micropower Shunt Voltage Reference with Multiple Reverse Breakdown Voltages

Ordering Information (continued)

| PART | OUTPUT VOLTAGE (V) | INITIAL ACCURACY (%) | TEMPCO (ppm/°C) | TEMP RANGE | PIN-PACKAGE | TOP MARK |
|--------------------|--------------------|----------------------|-----------------|-----------------|-------------|----------|
| LM4040CEX3-4.1+T | 4.096 | 0.5 | 100 | -40°C to +125°C | 3 SC70 | ALT |
| LM4040DEM3-4.1+T | 4.096 | 1.0 | 150 | -40°C to +125°C | 3 SOT23 | FZNV |
| LM4040DEM3-4.1V+T* | 4.096 | 1.0 | 150 | -40°C to +125°C | 3 SOT23 | FZWA |
| LM4040DEX3-4.1+T | 4.096 | 1.0 | 150 | -40°C to +125°C | 3 SC70 | ALU |
| LM4040AIM3-5.0+T | 5.000 | 0.1 | 100 | -40°C to +85°C | 3 SOT23 | FZEV |
| LM4040AIM3-5.0V+T* | 5.000 | 0.1 | 100 | -40°C to +85°C | 3 SOT23 | +FZWB |
| LM4040AIX3-5.0+T | 5.000 | 0.1 | 100 | -40°C to +85°C | 3 SC70 | ABZ |
| LM4040BIM3-5.0+T | 5.000 | 0.2 | 100 | -40°C to +85°C | 3 SOT23 | FZEW |
| LM4040BIX3-5.0+T | 5.000 | 0.2 | 100 | -40°C to +85°C | 3 SC70 | ACA |
| LM4040CIM3-5.0+T | 5.000 | 0.5 | 100 | -40°C to +85°C | 3 SOT23 | FZEX |
| LM4040CIX3-5.0+T | 5.000 | 0.5 | 100 | -40°C to +85°C | 3 SC70 | ACB |
| LM4040DIM3-5.0+T | 5.000 | 1.0 | 150 | -40°C to +85°C | 3 SOT23 | FZEY |
| LM4040DIX3-5.0+T | 5.000 | 1.0 | 150 | -40°C to +85°C | 3 SC70 | ACC |
| LM4040AEM3-5.0+T | 5.000 | 0.1 | 100 | -40°C to +125°C | 3 SOT23 | FZNW |
| LM4040AEM3-5.0V+T | 5.000 | 0.1 | 100 | -40°C to +125°C | 3 SOT23 | FZWB |
| LM4040AEX3-5.0+T | 5.000 | 0.1 | 100 | -40°C to +125°C | 3 SC70 | ALV |
| LM4040BEM3-5.0+T | 5.000 | 0.2 | 100 | -40°C to +125°C | 3 SOT23 | FZNX |
| LM4040BEX3-5.0+T | 5.000 | 0.2 | 100 | -40°C to +125°C | 3 SC70 | ALW |
| LM4040CEM3-5.0+T | 5.000 | 0.5 | 100 | -40°C to +125°C | 3 SOT23 | FZNY |
| LM4040CEM3-5.0V+T | 5.000 | 0.5 | 100 | -40°C to +125°C | 3 SOT23 | +FZWC |
| LM4040CEX3-5.0+T | 5.000 | 0.5 | 100 | -40°C to +125°C | 3 SC70 | ALX |
| LM4040DEM3-5.0+T | 5.000 | 1.0 | 150 | -40°C to +125°C | 3 SOT23 | FZNZ |
| LM4040DEX3-5.0+T | 5.000 | 1.0 | 150 | -40°C to +125°C | 3 SC70 | ALY |

+Denotes a lead(Pb)-free/RoHS-compliant package.

T = Tape and reel.

*Denotes future product—contact factory for availability.

Chip Information

PROCESS: BiCMOS

Revision History

| REVISION NUMBER | REVISION DATE | DESCRIPTION | PAGES CHANGED |
|-----------------|---------------|---|------------------|
| 0 | 8/00 | Initial release | — |
| 5 | 7/05 | Updated <i>Electrical Characteristics</i> | 2–7 |
| 6 | 4/11 | Updated <i>Selector Guide</i> , <i>Absolute Maximum Ratings</i> , and <i>Ordering Information</i> | 1, 2, 12, 13, 14 |
| 7 | 11/11 | Add IV+ automotive-qualified identification to the <i>Selector Guide</i> and <i>Ordering Information</i> | 1, 12 |
| 8 | 3/13 | Updated <i>Ordering Information</i> and removed <i>Selector Guide</i> | 1, 13, 14 |
| 9 | 1/16 | Added IV part to <i>Ordering Information</i> table | 13 |
| 10 | 10/17 | Added AEC-Q100 qualification statement to <i>Benefits and Features</i> section | 1 |
| 11 | 10/18 | Updated <i>Applications</i> section, <i>Absolute Maximum Ratings</i> , <i>Package Information</i> and <i>Ordering Information</i> | 1, 2, 13–15 |
| 12 | 5/19 | Updated <i>Applications</i> , <i>Benefits and Features</i> , <i>Absolute Maximum Ratings</i> , <i>Electrical Characteristics</i> , <i>Ordering Information</i> , and added <i>Package Information</i> section | 1, 2, 14, 15 |

For pricing, delivery, and ordering information, please visit Maxim Integrated's online storefront at <https://www.maximintegrated.com/en/storefront/storefront.html>.

Maxim Integrated cannot assume responsibility for use of any circuitry other than circuitry entirely embodied in a Maxim Integrated product. No circuit patent licenses are implied. Maxim Integrated reserves the right to change the circuitry and specifications without notice at any time. The parametric values (min and max limits) shown in the *Electrical Characteristics* table are guaranteed. Other parametric values quoted in this data sheet are provided for guidance.



Компания «ЭлектроПласт» предлагает заключение долгосрочных отношений при поставках импортных электронных компонентов на взаимовыгодных условиях!

Наши преимущества:

- Оперативные поставки широкого спектра электронных компонентов отечественного и импортного производства напрямую от производителей и с крупнейших мировых складов;
- Поставка более 17-ти миллионов наименований электронных компонентов;
- Поставка сложных, дефицитных, либо снятых с производства позиций;
- Оперативные сроки поставки под заказ (от 5 рабочих дней);
- Экспресс доставка в любую точку России;
- Техническая поддержка проекта, помощь в подборе аналогов, поставка прототипов;
- Система менеджмента качества сертифицирована по Международному стандарту ISO 9001;
- Лицензия ФСБ на осуществление работ с использованием сведений, составляющих государственную тайну;
- Поставка специализированных компонентов (Xilinx, Altera, Analog Devices, Intersil, Interpoint, Microsemi, Aeroflex, Peregrine, Syfer, Eurofarad, Texas Instrument, Miteq, Cobham, E2V, MA-COM, Hittite, Mini-Circuits, General Dynamics и др.);

Помимо этого, одним из направлений компании «ЭлектроПласт» является направление «Источники питания». Мы предлагаем Вам помощь Конструкторского отдела:

- Подбор оптимального решения, техническое обоснование при выборе компонента;
- Подбор аналогов;
- Консультации по применению компонента;
- Поставка образцов и прототипов;
- Техническая поддержка проекта;
- Защита от снятия компонента с производства.



Как с нами связаться

Телефон: 8 (812) 309 58 32 (многоканальный)

Факс: 8 (812) 320-02-42

Электронная почта: org@eplast1.ru

Адрес: 198099, г. Санкт-Петербург, ул. Калинина, дом 2, корпус 4, литера А.