

N-Series

Hydraulic Magnetic Circuit Breaker

Product Highlights:

- 240 VAC, 277 VAC, 120/240 VAC
- UL 489 Compliant Sliding Terminal Barriers
- 22,000 Amps Max Interrupting Capacity
- 1 – 30 Amps Current Rating
- Optional Current Transformer
- EN60947-2 Certified

Typical Applications:

- Telecom/Datacom
 - Power Distribution Units
 - Data Servers
 - Data Storage



Resources:

Download 3D CAD Files

[IGS >](#) [STP >](#)

Watch Product Video



The high-performance N-Series hydraulic-magnetic circuit breaker is ideally suited for the rigors and confined spaces of telecom and datacom power distribution units and rack systems. Its innovative, low profile design features easily accessible load and line terminals and sliding barriers for effortless installation.

The optional current transformer allows for remote outlet metering and monitoring of power usage thus facilitating load adjustments and maximizing efficiency.

A patent pending, flush-rocker actuator and push-to-reset guard offer additional protection against accidental switching.



Carling Technologies™

Innovative Designs. Powerful Solutions.

Carling Technologies, Inc.

60 Johnson Avenue, Plainville, CT 06062

Email: sales@carlingtech.com

Application Support: team2@carlingtech.com

Phone: 860.793.9281 Fax: 860.793.9231

www.carlingtech.com

N-Series Circuit Breaker

DESIGN FEATURES

CURRENT TRANSFORMER

Remote current sensing via molex connector

UPPER ARC RUNNER

Optional, for 277 VAC rated breakers

GRIDS (5x)

Arc deionizing splitter plates that increase arc voltage for quick interrupt

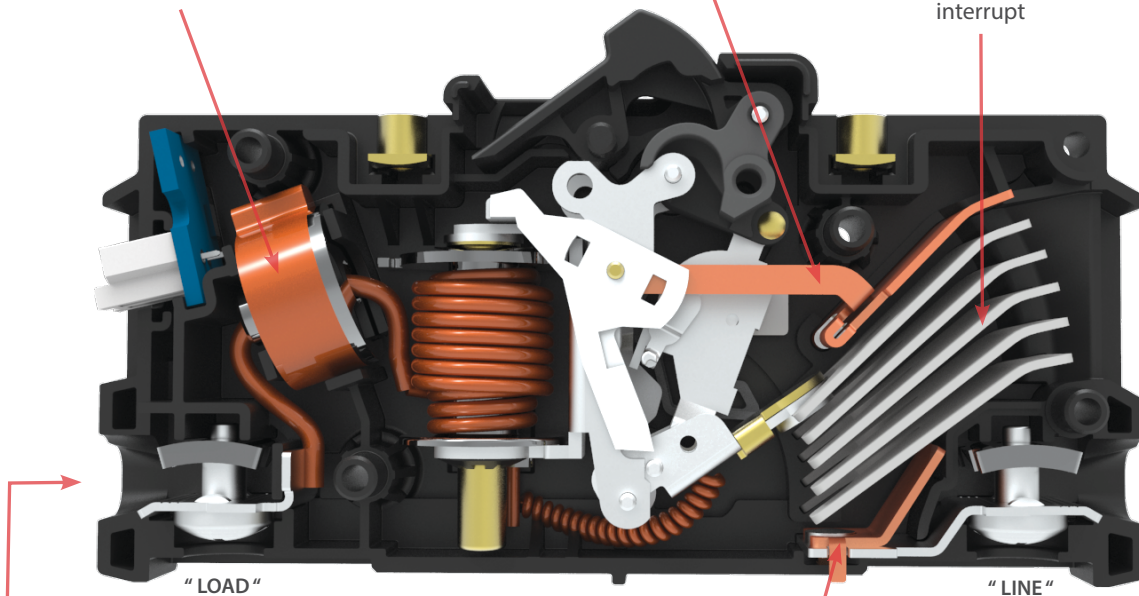

TERMINAL

Allows for easy hook-up of wires on both sides of the breaker

LOWER ARC RUNNER

Motivates arc off of the stationary contact

SLIDING TERMINAL BARRIERS

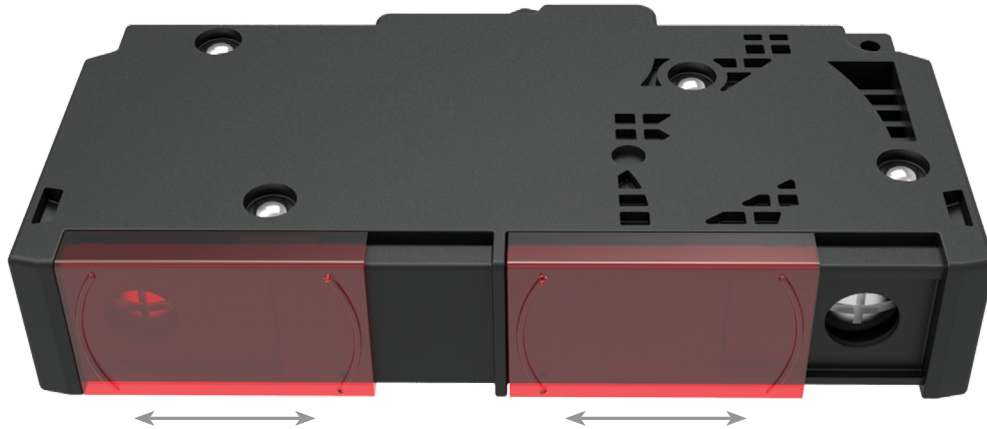

Electrical Tables

Table 1: Voltage and Current Ratings

| N-SERIES TABLE 1: ELECTRICAL RATINGS | | | | | | |
|--------------------------------------|----------------|-----------------|---------------------------|---------|-----------------------|---------|
| VOLTAGE | CURRENT (AMPS) | NUMBER OF POLES | INTERRUPT CAPACITY (AMPS) | | | |
| | | | UL 489 | | EN60947-2 (Ics & Icu) | |
| | | | 1-20 A | 21-30 A | 1-20 A | 21-30 A |
| 120/240 VAC | 1 - 30 | 2 | 10000 | 5000 | 5000 | 5000 |
| 240 VAC | 1 - 20 | 1 | 22000 | N/A | 5000 | 5000 |
| 277 VAC | 1 - 20 | 1 | 10000 | N/A | N/A | N/A |

Table 2: Time Delay

| N-SERIES TABLE 2: TIME DELAY OPTIONS | | |
|--------------------------------------|----------|-------------------|
| DELAY CURVE NUMBER | VOLTAGE | DESCRIPTION |
| 21 | 50/60 Hz | Ultrashort |
| 22 | 50/60 Hz | Short |
| 24 | 50/60 Hz | Medium |
| 26 | 50/60 Hz | Long |
| 42 | 50/60 Hz | Hi-inrush, Short |
| 44 | 50/60 Hz | Hi-inrush, Medium |
| 46 | 50/60 Hz | Hi-inrush, Long |

Electrical: Impedance / Resistance

RESISTANCE, IMPEDANCE VALUES

Across Line and Load Terminals

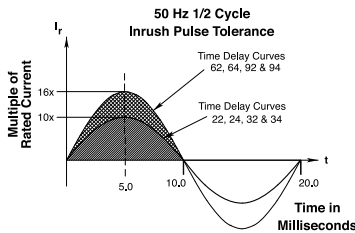
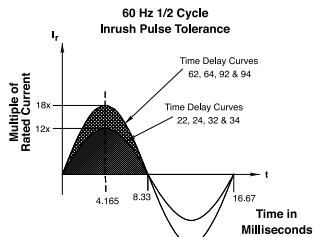
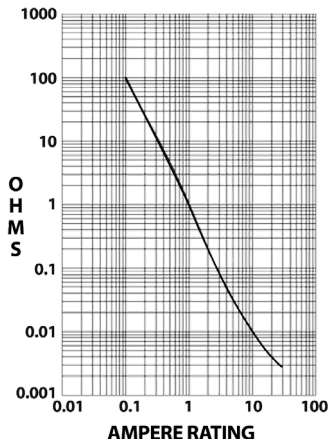

| Current (amps) | Tolerance (%) |
|----------------|---------------|
| 0.1 - 5.0 | +/-15 |
| 5.1 - 30.0 | +/-25 |

Electrical

Current Metering

Integrated current transformer.
 Measurement range: 1-30 Amps.
 Voltage output: 10mV per Amp according to the formula below:
 $2 \text{ (Amp)} \leq I \leq 30 \text{ (Amp)}$
 $V = 0.01 \cdot I \pm 2\%$

$$\left| \frac{\frac{V}{I} - \frac{V_{10}}{I_{10}}}{\frac{V_{10}}{I_{10}}} \right| \leq 0.85\%$$

Where V=CT output in volts
 V_{10} =CT output in volts with $I=I_{10}=10 \text{ (A)}$; I =primary current in amperage (50/60 Hz). Phase shift between primary current and CT output is $0.25 \pm 0.25^\circ$. Maximum crest factor of primary current is 1.73. R1 shall be integrated in the breaker. R2 and R3 are provided by end user and external to the breaker.
 Connection: below Load Terminal.
 2-pin connector, Molex 35362-0250.
 Mating Connector housing – Molex PN35507-0200.

(Current metering is available on AC rated devices only)

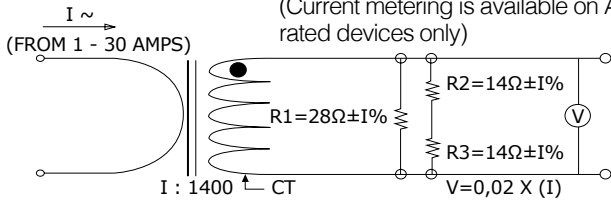

Dielectric Strength

UL, CSA-1960V 50/60 Hz for one minute between all electrically isolated terminals. Comply with the 8mm spacing and 3750V 50/60 Hz dielectric requirements from hazardous voltage to operator accessible surfaces and between main circuits of adjacent poles per Publications EN 60950 and VDE 0805

Insulation Resistance Overload

Minimum of 100 Megohms @ 500VDC
 50 operations @ 600% of rated current for AC rated devices

Interrupt Capacity

See table 1

Mechanical

Endurance

10,000 "On-Off" operations @ 6 per minute; with rated current & voltage
 Trips on overload even when actuator is forcibly held in the "On" position

Trip Free

The operating actuator moves positively to the "Off" position when an overload causes the breaker to trip

Trip Indication

Environmental

Environmental Operating Temperature Vibration

MIL-PRF-55629 and MIL-STD-202G
 -40°C to +85°C
 Withstands 0.06" excursion from 10-55 Hz and 10Gs 55-500 Hz at rated current per MIL-PRF-55629 and MIL-STD-202G, Method 204D, Test Condition A. Instantaneous and ultra-short curves tested at 90% of rated current

Shock

Withstands 50 Gs, 6 ms saw tooth while carrying rated current per MIL-PRF-55629 and MIL-STD-202G, Method 213B, test condition "I". Instantaneous and ultra short curves tested at 90% of rated current

Thermal Shock

MIL-PRF-55629 and MIL-STD-202G, Method 107G, Condition A (5-cycles at -55°C to +25°C to +85°C to +25°C)

Moisture Resistance

MIL-PRF-55629 and MIL-STD-202G, Method 106G, i.e., Ten 24-hour cycles at +25°C to +65°C, 80-98% RH Method 101, Condition A (90-95% RH @ 5% NaCl Solution, 96hrs)

Salt Spray

Physical

Number of Poles Termination

1 - 2 poles
 Wire ready and touch proof wire clamp (See Figure 1). Accepts up to (2) #10 AWG wires per terminal. Designed for use with solid, stranded and flexible stranded wires, with or without ferrule or pin terminals. Also accepts straight fork and flanged fork terminals.

Termination Torque Termination Barrier

15-20 in-lbs (Line & Load terminals)
 Integral sliding barrier to comply with spacing requirements (See figure 1)

Mounting

Threaded Insert: #6-32 UNC-2B, or M3X0.5-6H B ISO (2 per Pole)

Insert Termination Torque Actuator

7-9 in-lbs
 Rocker, with or without guard (See figures 1, 2, and 4)

Internal Circuit Config. Materials

Series Trip
 Housing - Glass Filled Polyester
 Rocker - Nylon
 Line/Load Terminals - Copper Alloy; Bright Acid Tin Plated

Weight Standard Color

~107 grams (~3.76 ounces) per pole
 Housing - Black. Rocker - Several (See ordering scheme for colors)

Agency Approvals

UL 489, cUL, TUV EN60947-2

*Manufacturer reserves the right to change product specification without prior notice.

Form & Fit

Figure 1. N-Series 1-Pole Construction

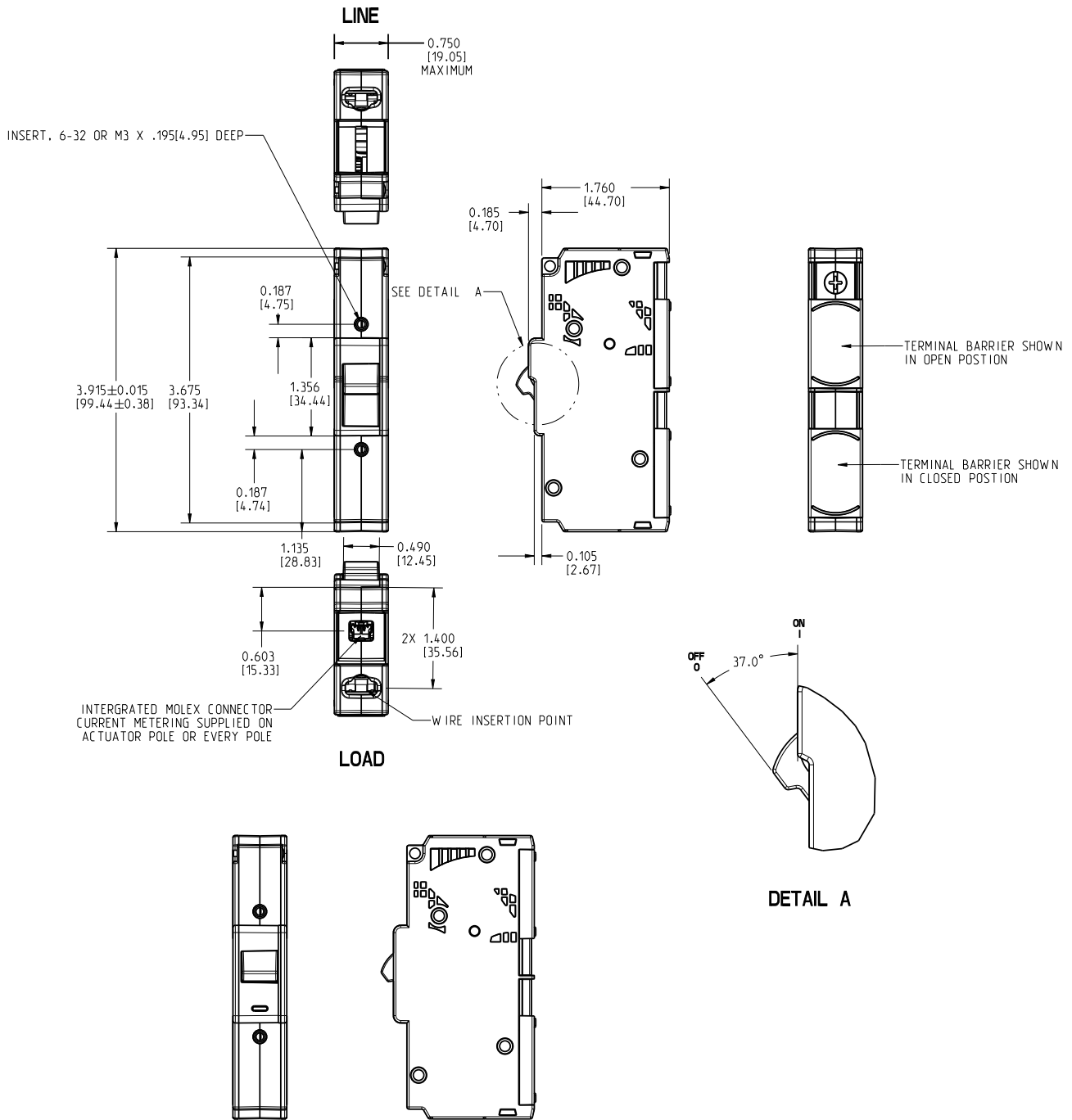

PUSH TO RESET
ACTUATOR

Notes:

- 1 All dimensions are in inches [millimeters].
- 2 Tolerance ±.020 [.51] unless otherwise specified.

Form & Fit

Figure 2. N-Series 2-Pole Construction

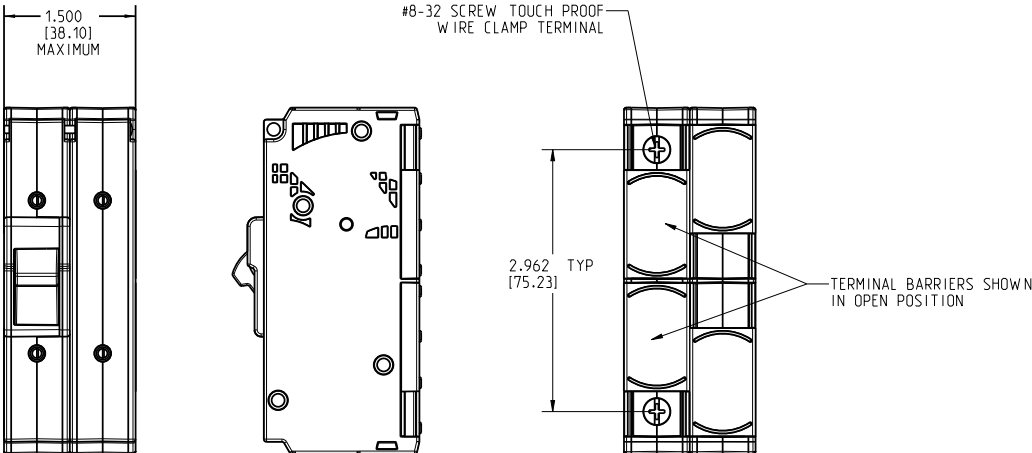
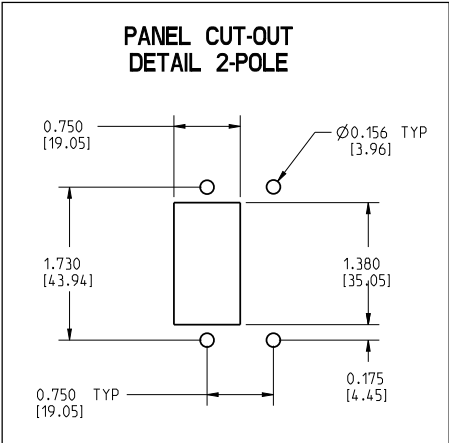

Figure 3. N-Series Panel Cut-Out



- Notes:
- 1 All dimensions are in inches [millimeters].
 - 2 Tolerance ± 0.020 [.51] unless otherwise specified.

Time Delay Curves

Ultrashort - AC 21

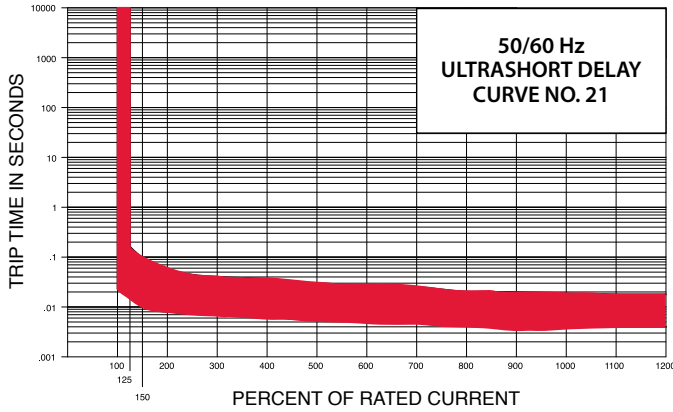

Short - AC 22

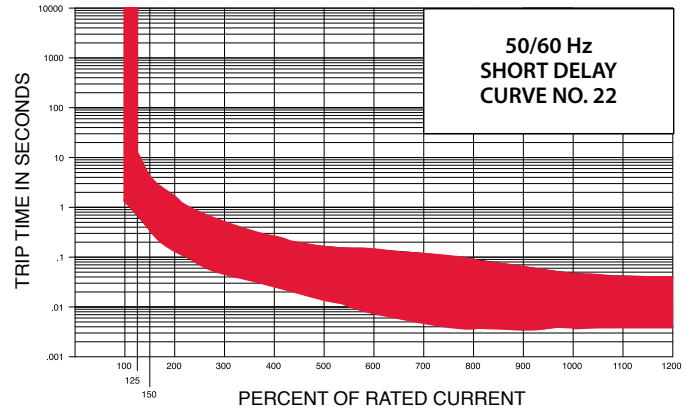

Medium - AC 24

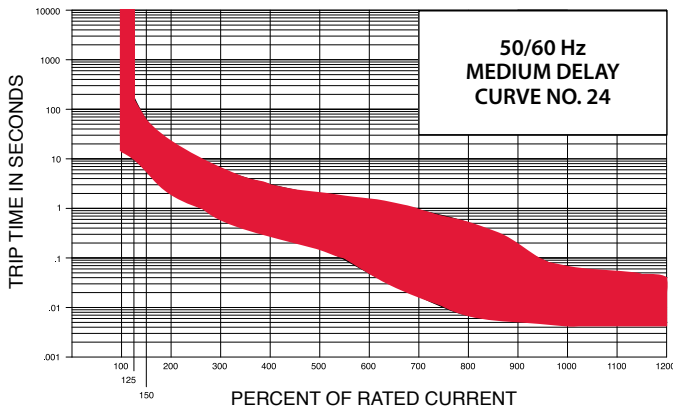

Long - AC 26

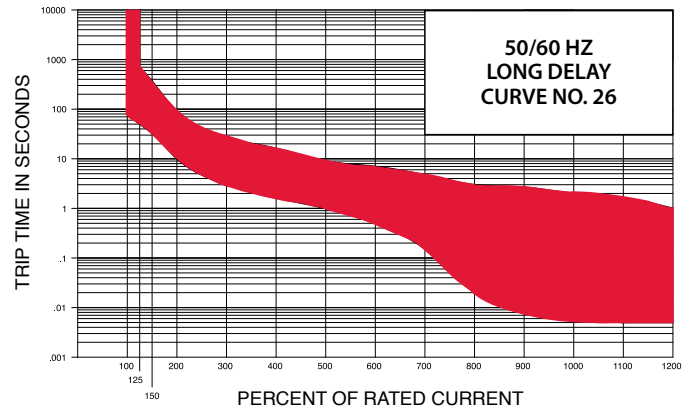

Time Delay Curves

Hi-Inrush Short - AC 42

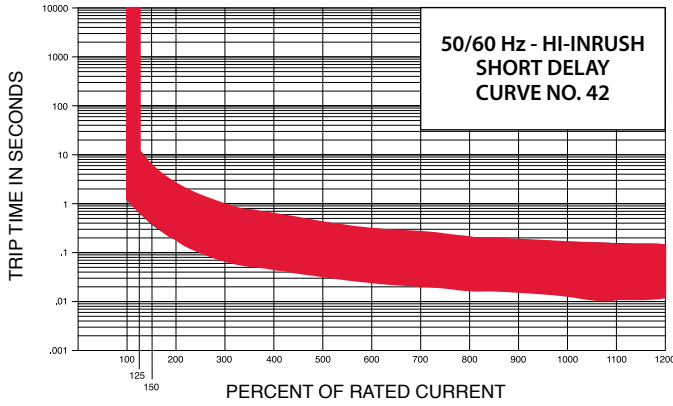

Hi-Inrush Medium - AC 44

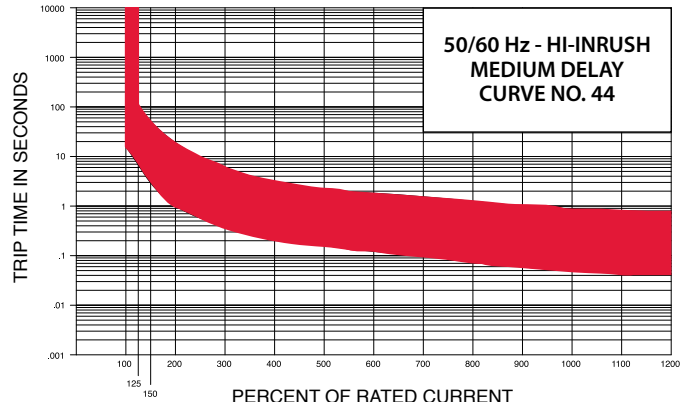

Hi-Inrush Long - AC 46

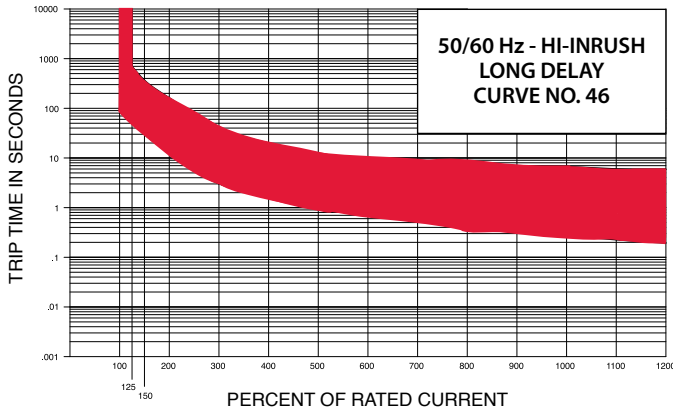

Authorized Sales Representatives

Click on the group name on the map below to find your local representative or visit www.carlingtech.com/findarep.

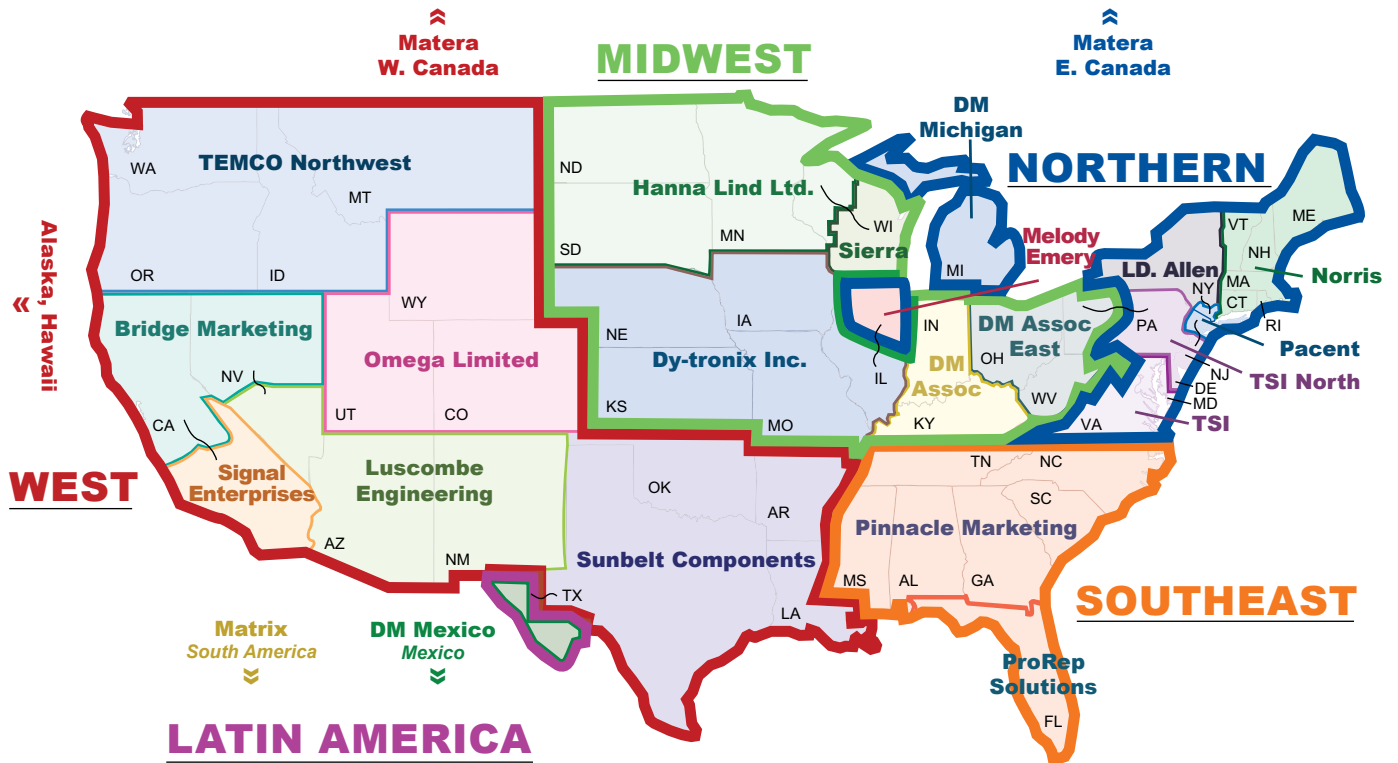

About Carling

Founded in 1920, Carling Technologies is a leading manufacturer of electrical and electronic switches and assemblies, circuit breakers, electronic controls, power distribution units, and multiplexed power distribution systems. With four ISO registered manufacturing facilities and technical sales offices worldwide, Carling Technologies Sales, Service and Engineering teams do much more than manufacture electrical components, they engineer powerful solutions! To learn more about Carling please visit www.carlingtech.com/company-profile.

To view all of Carling’s environmental, quality, health & safety certifications please visit www.carlingtech.com/environmental-certifications

Worldwide Headquarters

Carling Technologies, Inc.
60 Johnson Avenue, Plainville, CT 06062
Phone: 860.793.9281 **Fax:** 860.793.9231
Email: sales@carlingtech.com

Northern Region Sales Office: nrsm@carlingtech.com
Southeast Region Sales Office: sersm@carlingtech.com
Midwest Region Sales Office: mrrsm@carlingtech.com
West Region Sales Office: wrsm@carlingtech.com
Latin America Sales Office: larsm@carlingtech.com

Asia-Pacific Headquarters

Carling Technologies, Asia-Pacific Ltd.,
Kowloon, Hong Kong
Phone: Int + 852-2737-2277 **Fax:** Int + 852-2736-9332
Email: sales@carlingtech.com.hk

Shenzhen, China: shenzhen@carlingtech.com
Shanghai, China: shanghai@carlingtech.com
Pune, India: india@carlingtech.com
Kaohsiung, Taiwan: taiwan@carlingtech.com
Yokohama, Japan: japan@carlingtech.com

Europe | Middle East | Africa Headquarters

Carling Technologies LTD
4 Airport Business Park, Exeter Airport,
Clyst Honiton, Exeter, Devon, EX5 2UL, UK
Phone: Int + 44 1392.364422 **Fax:** Int + 44 1392.364477
Email: ltd.sales@carlingtech.com

Germany: gmbh@carlingtech.com
France: sas@carlingtech.com



Carling Technologies™

Innovative Designs. Powerful Solutions.



Компания «ЭлектроПласт» предлагает заключение долгосрочных отношений при поставках импортных электронных компонентов на взаимовыгодных условиях!

Наши преимущества:

- Оперативные поставки широкого спектра электронных компонентов отечественного и импортного производства напрямую от производителей и с крупнейших мировых складов;
- Поставка более 17-ти миллионов наименований электронных компонентов;
- Поставка сложных, дефицитных, либо снятых с производства позиций;
- Оперативные сроки поставки под заказ (от 5 рабочих дней);
- Экспресс доставка в любую точку России;
- Техническая поддержка проекта, помощь в подборе аналогов, поставка прототипов;
- Система менеджмента качества сертифицирована по Международному стандарту ISO 9001;
- Лицензия ФСБ на осуществление работ с использованием сведений, составляющих государственную тайну;
- Поставка специализированных компонентов (Xilinx, Altera, Analog Devices, Intersil, Interpoint, Microsemi, Aeroflex, Peregrine, Syfer, Eurofarad, Texas Instrument, Miteq, Cobham, E2V, MA-COM, Hittite, Mini-Circuits, General Dynamics и др.);

Помимо этого, одним из направлений компании «ЭлектроПласт» является направление «Источники питания». Мы предлагаем Вам помощь Конструкторского отдела:

- Подбор оптимального решения, техническое обоснование при выборе компонента;
- Подбор аналогов;
- Консультации по применению компонента;
- Поставка образцов и прототипов;
- Техническая поддержка проекта;
- Защита от снятия компонента с производства.



Как с нами связаться

Телефон: 8 (812) 309 58 32 (многоканальный)

Факс: 8 (812) 320-02-42

Электронная почта: org@eplast1.ru

Адрес: 198099, г. Санкт-Петербург, ул. Калинина, дом 2, корпус 4, литера А.