

General Description

The MAX17681 evaluation kit (EV kit) is a fully assembled and tested circuit board that demonstrates the performance of the MAX17681 high-efficiency, iso-buck DC-DC converter. The EV kit operates over a wide input voltage range of 17V to 32V and uses primary-side feedback to regulate the output voltage. The EV kit has two output configurations. In the first configuration, the output is programmed to $\pm 15\text{V}$ at 100mA, with $\pm 10\%$ output-voltage regulation. The second configuration uses a post regulator (MAX17651) to produce $\pm 12\text{V}$ at 50mA with $< \pm 3\%$ regulation.

The EV kit comes installed with the MAX17681 in a 10-pin (3mm x 2mm) TDFN package and MAX17651 in a 6-pin TSOT package.

Features

- 17V to 32V Input Voltage Range
- $\pm 15\text{V}$, 100mA or $\pm 12\text{V}$, 50mA Continuous Current
- EN/UVLO Input
- 200kHz Switching Frequency
- 90% Peak Efficiency
- Overcurrent Protection
- No Optocoupler
- Delivers Up to 3W Output Power
- Overtemperature Protection
- Proven PCB layout

Ordering Information appears at end of data sheet.

Quick Start

Recommended Equipment

- One 15V to 60V DC, 0.5A power supply
- Two loads of 50mA to 100mA sink capacity
- Four digital multimeters (DMM)

Caution: Do not turn on the power supply until all connections are completed.

Procedure

The EV kit comes with default output configuration programmed to $\pm 15\text{V}$.

Test Procedure for $\pm 15\text{V}$ Output

- 1) Verify that jumper JU1 is open.
- 2) Verify that the R17–R19 are not installed.
- 3) Set the power-supply output to 24V. Disable the power supply.
- 4) Connect the positive terminal of the power supply to the VIN PCB pad and the negative terminal to the nearest PGND PCB pad. Connect the positive terminal of the first 100mA load to the +15V PCB pad and the negative terminal to the nearest GND0 PCB pad. Connect the positive terminal of the second 100mA load to the GND0 PCB pad and the negative terminal to the nearest -15V PCB pad.
- 5) Connect a DMM configured in voltmeter mode across the +15V PCB pad and the nearest GND0 PCB pad. Connect another DMM configured in voltmeter mode across the -15V PCB pad and the nearest GND0 PCB pad.
- 6) Enable the input power supply.
- 7) Enable the loads and verify that the output voltage is at $\pm 15\text{V}$ with respect to GND.
- 8) If required, vary the input voltage from 17V to 32V, the load current from 0 to 100mA, and verify that the output voltage is $\pm 15\text{V}$.

Test Procedure for $\pm 12V$ Output

- 1) Verify that JU1 is open.
- 2) Remove R16 and R10. Place 0 Ω resistors in R18 and R19. Place a 681k Ω pack-out resistor (comes with EV kit package) in R17.
- 3) Set the power-supply output to 24V. Disable the power supply.
- 4) Connect the positive terminal of the power supply to the VIN PCB pad and the negative terminal to the nearest PGND PCB pad. Connect the positive terminal of the first 50mA load to the +12V PCB pad and the negative terminal to the nearest GND0 PCB pad. Connect the positive terminal of the second 50mA load to the GND0 PCB pad and the negative terminal to the nearest -12V PCB pad.
- 5) Connect a DMM configured in voltmeter mode across the +12V PCB pad and the nearest GND0 PCB pad. Connect another DMM configured in voltmeter mode across the -12V PCB pad and the nearest GND0 PCB pad.
- 6) Enable the input power supply.
- 7) Enable the loads and verify that the output voltage is at $\pm 12V$ with respect to GND.
- 8) If required, vary the input voltage from 17V to 32V, the load current from 0 to 50mA, and verify that the output voltage is $\pm 12V$.

Detailed Description

The EV kit is a fully assembled and tested circuit board that demonstrates the performance of the MAX17681 high-efficiency, iso-buck DC-DC converter designed to provide isolated power up to 3W. The EV kit generates either $\pm 15V$, 100mA or $\pm 12V$, 50mA output voltages from a 17V to 32V input supply. The EV kit features a forced-PWM control scheme that provides constant switching-frequency of 200kHz operation at all load and line conditions.

The EV kit includes an EN/UVLO PCB pad to enable control of the converter output. The VPRI PCB pad helps measure the regulated nonisolated buck voltage. An additional RESET PCB pad is available for monitoring FB regulated voltage, the open-drain logic output. The programmable soft-start feature allows users to reduce input inrush current.

The iso-buck is a synchronous-buck-converter-based topology, useful for generating isolated outputs at low power level without using an optocoupler. The detailed procedure for setting the soft-start time, ENABLE/UVLO divider, primary output-voltage (V_{PRI}) selection, adjusting the primary output voltage, primary inductance selection, turns-ratio selection, output capacitor selection, output diode selection, and external loop compensation are given in the MAX17681 IC data sheet. The post-regulator MAX17651 output-voltage setting and additional related information are detailed in the MAX17651 IC data sheet.

Enable Control (JU1)

The EN/UVLO pin on the device serves as an on/off control while also allowing the user to program the input undervoltage-lockout (UVLO) threshold. JU1 configures the EV kit's output for on/off control. Install a shunt across JU1 pins 2-3 to disable VOUT. See [Table 1](#) for proper JU1 jumper configurations.

Table 1. Enable Control (EN/UVLO) (JU1) Jumper Settings

SHUNT POSITION	EN/UVLO PIN	VOUT OUTPUT
1-2	Connected to VIN	Enabled
2-3	Connected to GND	Disabled
Open*	Connected to midpoint of R1, R2 resistor-divider	Enabled at $V_{IN} \geq 15.5V$

*Default position.

EV Kit Performance Report

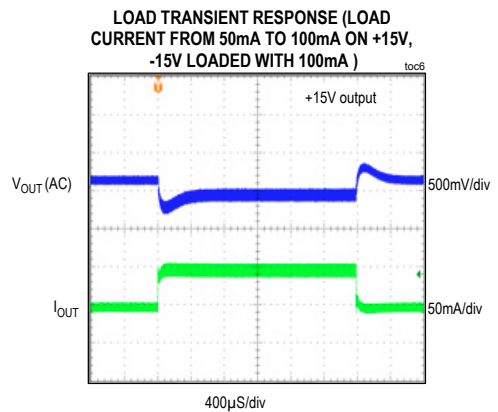
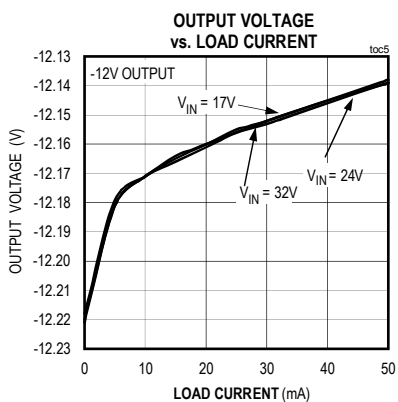
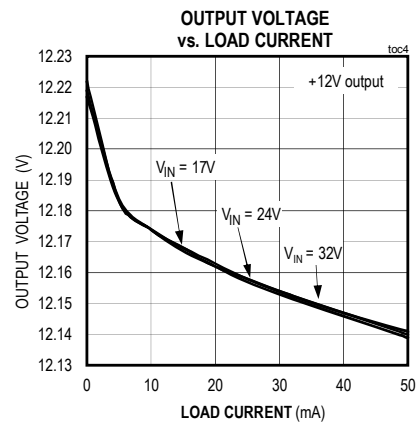
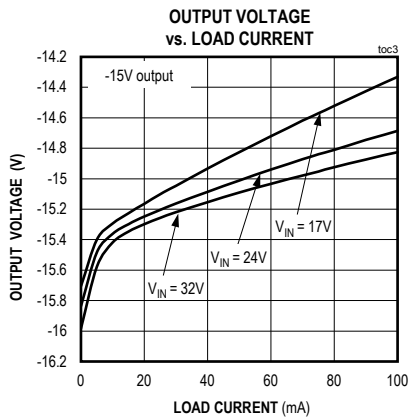
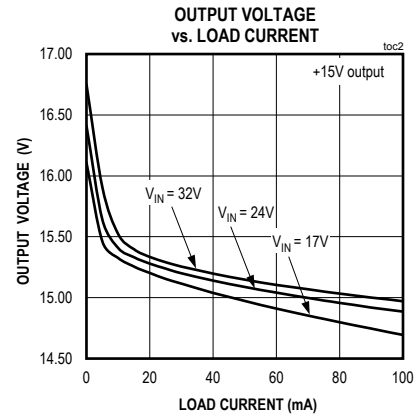
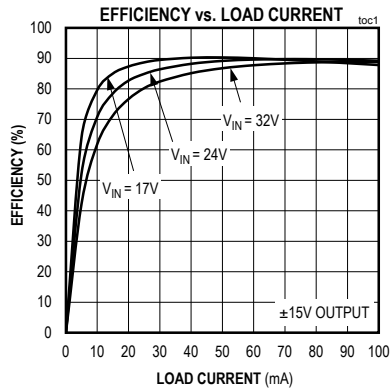

MAX17681 Evaluation Kit

Evaluates: MAX17681 for Isolated $\pm 15V$ or $\pm 12V$ Output Configuration

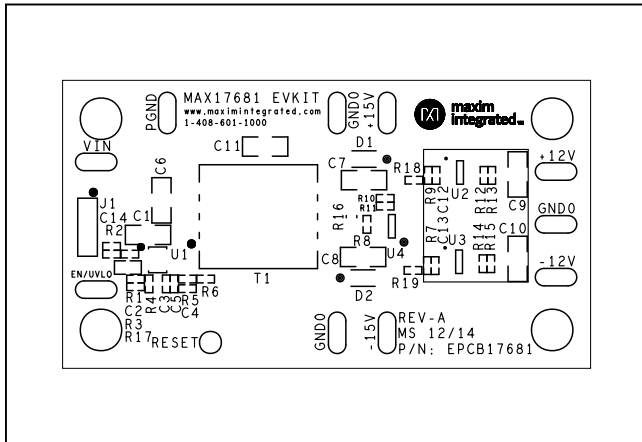

Figure 1. MAX17681 EV Kit Component Placement Guide—Component Side

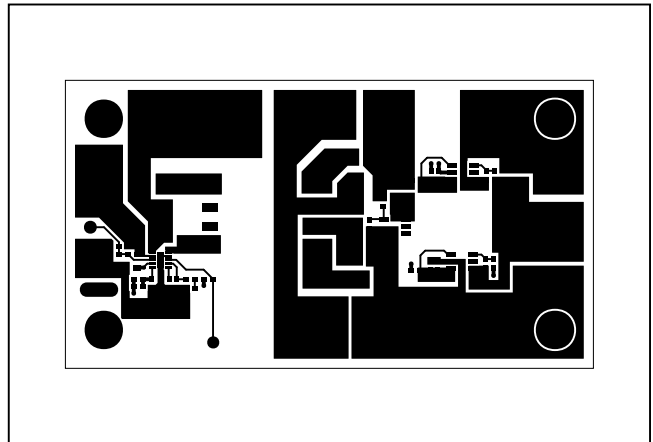

Figure 2. MAX17681 EV Kit PCB Layout—Component Side

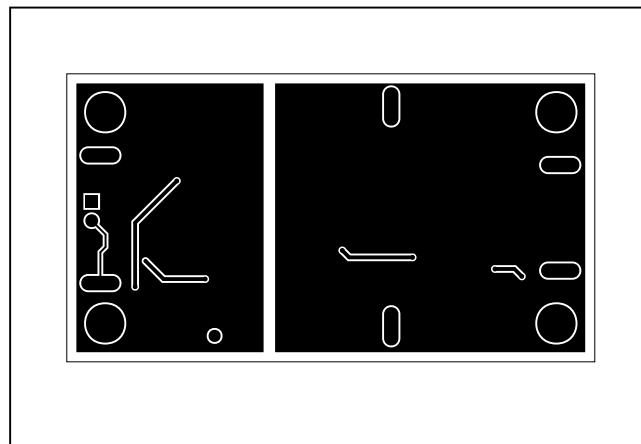

Figure 3. MAX17681 EV Kit PCB Layout—Solder Side

Component Suppliers

SUPPLIER	WEBSITE
Würth Elektronik	www.we-online.com
Murata Americas	www.murata.com
Panasonic Corp.	www.panasonic.com

Note: Indicate that you are using the MAX17681 when contacting these component suppliers.

Component List and Schematic

See the following links for component information and schematic:

- [MAX17681 EV BOM](#)
- [MAX17681 EV Schematic](#)

Ordering Information

PART	TYPE
MAX17681EVKIT#	EV Kit

#Denotes RoHS compliant.

Revision History

REVISION NUMBER	REVISION DATE	DESCRIPTION	PAGES CHANGED
0	5/15	Initial release	—
1	6/15	Updated <i>Typical Operating Characteristics</i> section, BOM, and schematic	1-3

For pricing, delivery, and ordering information, please contact Maxim Direct at 1-888-629-4642, or visit Maxim Integrated's website at www.maximintegrated.com.

Maxim Integrated cannot assume responsibility for use of any circuitry other than circuitry entirely embodied in a Maxim Integrated product. No circuit patent licenses are implied. Maxim Integrated reserves the right to change the circuitry and specifications without notice at any time.

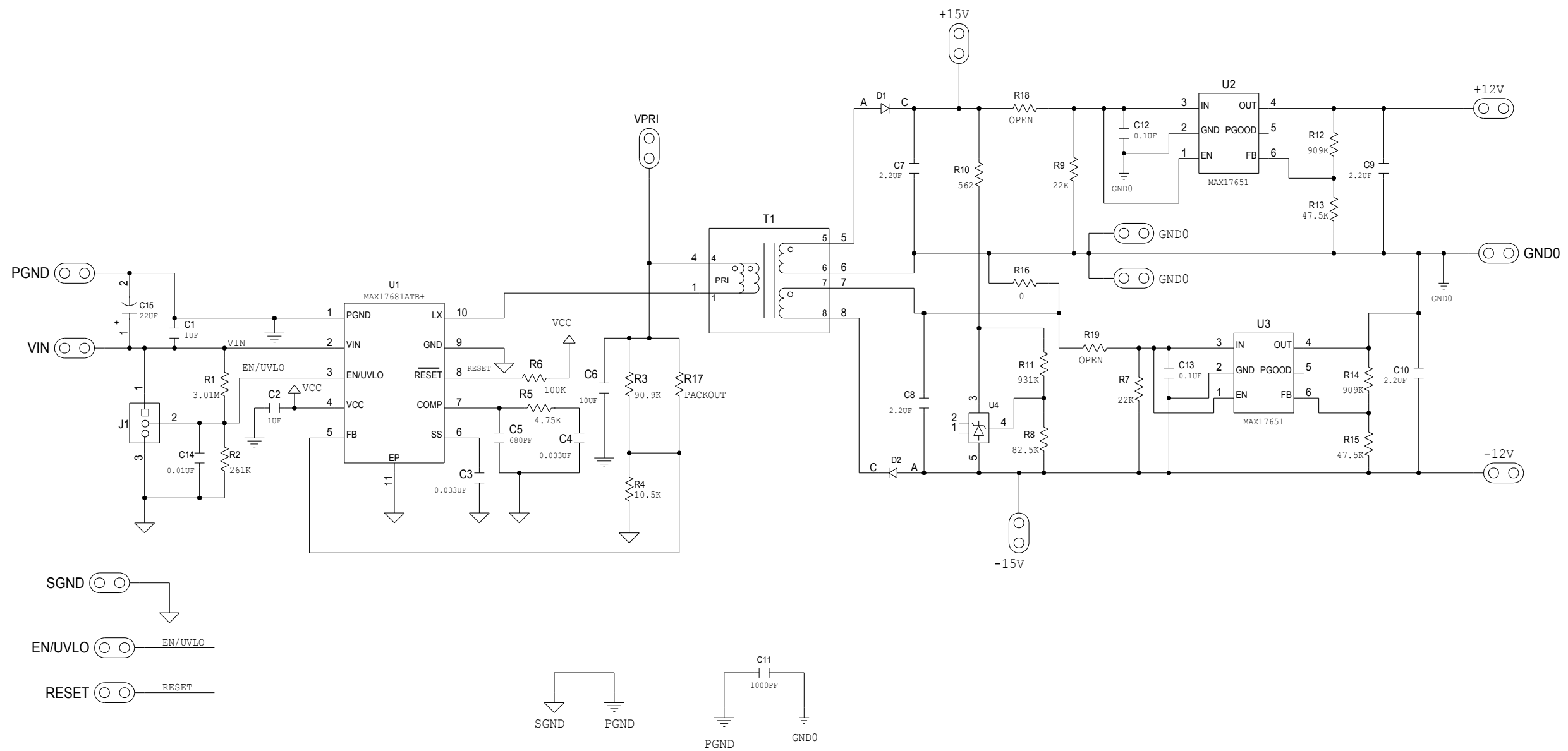

S NO	Designation	Qty	Description	Manufacturer Partnumber-1	Manufacturer Partnumber-2	Manufacturer Partnumber-3	Manufacturer Partnumber-4
1	C1	1	1 μ F \pm 10%, 50V,X7R Ceramic capacitor (1206)	Murata GRM31CR71H105KA61	KEMET C1206C105K5RAC	Murata GRM31MR71H105KA88	
2	C2	1	1 μ F \pm 10% 16V X7R Ceramic capacitor (0603)	Murata GRM188R71C105KA12	KEMET C0603C105K4RAC	TDK C1608X7R1C105K	TAIYO YUDEN EMK107B7105KA
3	C3,C4	2	33nF \pm 10%,25V, X7R ceramic capacitor (0402)	Murata GRM155R71E333KA88			
4	C5	1	680pF \pm 5%,50V,X7R ceramic capacitor (0402)	Murata GRM1555C1H681JA01	TDK C1005C0G1H681G050	VENKEL LTD C0402C0G500-681JNP	Murata GRM1555C1H681GA01
5	C6	1	10uF \pm 10%,16V, X7R ceramic capacitor (1206)	Murata GRM31CR71C106KAC7			
6	C7,C8,C9,C10	4	2.2uF \pm 10%,50V, X7R ceramic capacitor (1206)	Murata GRM31CR71H225KA88	TAIYO YUDEN UMK316B7225K		
7	C11	1	1000PF \pm 10%,1500V, X7R ceramic capacitor (1206)	AVX 1206SC102KAT			
8	C12,C13	2	0.1uF \pm 10%, 25V, C0G ceramic capacitor(0402)	Murata GRM155R71E104KE14			
9	C14	1	0.01uF \pm 10%, 50V, X7R ceramic capacitor (0402)	Murata GRM155R71H103KA88	KEMET C0402C103K5RAC		
10	C15	1	22uF, 20%, 50V, ALUMINUM ELECTROLYTIC CAPACITOR 6.60*6.60mm	Panasonic EEEFK1H220P			
11	JU1	1	3-pin headers	SULLINS ELECTRONICS CORP PEC03SAAN			
12	D1,D2	2	200V/1A, PowerDI@123	Diode Inc. DFSL1200-7			
13	R1	1	3.01M Ohm \pm 1% resistor (0402)	VISHAY DALE CRCW04023M01FK			
14	R2	1	261K Ohm \pm 1% resistor (0402)	VISHAY DALE CRCW0402261KFK			
15	R3	1	90.9K Ohm \pm 1% resistor (0402)	PANASONIC ERJ-2RKF9092X			
16	R4	1	10.5k Ω \pm 1% resistor (0402)	PANASONIC ERJ-2RKF1052			
17	R5	1	4.75k Ω \pm 1% resistor (0402)	VISHAY DALE CRCW04024K75FK			
18	R6	1	100k Ω \pm 5% resistor (0402)	PANASONIC ERJ-2GEJ104X			
19	R7,R9	2	22k Ω \pm 1% resistor (0402)	VISHAY DALE CRCW040222K0FK			
20	R8	1	82.5k Ω \pm 1% resistor (0402)	VISHAY DALE CRCW040282K5FK	BOURNS CR0402-FX- 8252GLF		
21	R10	1	562 Ω \pm 1% resistor (0402)	PANASONIC ERJ-2RKF5620X			
22	R11	1	931k Ω \pm 1% resistor (0402)	VISHAY DALE CRCW0402931KFK			
23	R12,R14	2	909k Ω \pm 1% resistor (0402)	VISHAY DALE CRCW0402909KFK			

24	R13,R15	2	47.5k Ω \pm 1% resistor (0402)	VISHAY DALE CRCW04024752FK	VISHAY DALE 9C04021A4752FLHF3	VISHAY DALE CRCW040247K5FK	
25	R16	1	0 Ω \pm 5% resistor (0805)	YAGEO PHYCOMP RC0805JR-070RL			
26	R17	1	OPEN				
27	R18,R19	2	OPEN				
28	T1	1	EP10, 8-pin SMT, 50 μ H, 1.4A, (1-4):(5-6):(7-8) = 1:1.8:1.8	WURTH ELECTRONICS INC. 750342557			
29	U1	1	MAX17681 TDFN10 3*2mm Iso buck DC-DC converter	MAX17681ATB+			
30	U2,U3	1	MAX17651 TSOT LDO	MAX17651AZT+			
31	U4	1	Shunt regulator SOT25	Diode Inc. TL431BW5			



Компания «ЭлектроПласт» предлагает заключение долгосрочных отношений при поставках импортных электронных компонентов на взаимовыгодных условиях!

Наши преимущества:

- Оперативные поставки широкого спектра электронных компонентов отечественного и импортного производства напрямую от производителей и с крупнейших мировых складов;
- Поставка более 17-ти миллионов наименований электронных компонентов;
- Поставка сложных, дефицитных, либо снятых с производства позиций;
- Оперативные сроки поставки под заказ (от 5 рабочих дней);
- Экспресс доставка в любую точку России;
- Техническая поддержка проекта, помощь в подборе аналогов, поставка прототипов;
- Система менеджмента качества сертифицирована по Международному стандарту ISO 9001;
- Лицензия ФСБ на осуществление работ с использованием сведений, составляющих государственную тайну;
- Поставка специализированных компонентов (Xilinx, Altera, Analog Devices, Intersil, Interpoint, Microsemi, Aeroflex, Peregrine, Syfer, Eurofarad, Texas Instrument, Miteq, Cobham, E2V, MA-COM, Hittite, Mini-Circuits, General Dynamics и др.);

Помимо этого, одним из направлений компании «ЭлектроПласт» является направление «Источники питания». Мы предлагаем Вам помощь Конструкторского отдела:

- Подбор оптимального решения, техническое обоснование при выборе компонента;
- Подбор аналогов;
- Консультации по применению компонента;
- Поставка образцов и прототипов;
- Техническая поддержка проекта;
- Защита от снятия компонента с производства.



Как с нами связаться

Телефон: 8 (812) 309 58 32 (многоканальный)

Факс: 8 (812) 320-02-42

Электронная почта: org@eplast1.ru

Адрес: 198099, г. Санкт-Петербург, ул. Калинина, дом 2, корпус 4, литера А.