

Double-Balanced Mixer

Rev. V4

Features

- LO 10 TO 1000 MHz
- RF 10 TO 1000 MHz
- F DC TO 600 MHz
- LO DRIVE: +20 dBm (nominal)
- HIGH INTERCEPT POINT: +30 dBm (TYP.)
- HERMETICALLY SEALED

Description

The M2E is a double balanced mixer, designed for use in military, commercial, and test equipment applications. The design utilizes Schottky ring quad diodes and broadband ferrite baluns to attain excellent performance. This mixer can also be used as a phase detector and/or bi-phase modulator since the IF port is DC coupled to the diodes. Environmental screening is available to MIL-STD-883, MIL-STD-202, or MIL-DTL-28837, consult factory.

Ordering Information

Part Number	Package
M2E	TO-8
M2EC	SMA Connectorized
SM2E	Surface Mount

Product Image

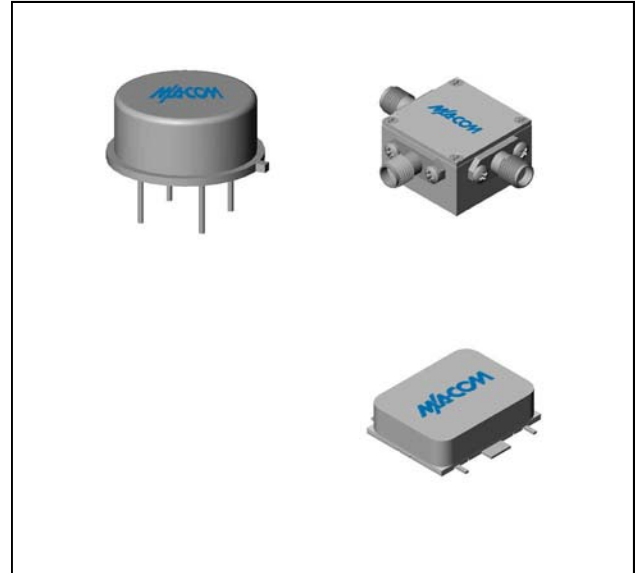

Electrical Specifications: $Z_0 = 50\Omega$ $Lo = +20$ dBm (Downconverter application only)

Parameter	Test Conditions	Units	Typical	Guaranteed	
				+25°C	-54° to +85°C *
SSB Conversion Loss (max) & SSB Noise Figure (max)	fR = 0.01 to 0.3 GHz, fL = 0.01 to 0.3 GHz, fl = 0.01 to 0.2 GHz	dB	7.0	7.5	7.8
	fR = 0.01 to 0.3 GHz, fL = 0.01 to 0.3 GHz, fl = 0.01 to 0.6 GHz	dB	8.0	9.0	9.3
	fR = 0.01 to 1 GHz, fL = 0.01 to 1 GHz, fl = 0.01 to 0.2 GHz	dB	8.5	9.5	9.8
	fR = 0.01 to 1 GHz, fL = 0.01 to 1 GHz, fl = 0.01 to 0.6 GHz	dB	10.0	11.0	11.3
Isolation, L to R (min)	fL = 0.01 to 0.1 GHz	dB	40	35	34
	fL = 0.1 to 0.4 GHz	dB	35	25	24
	fL = 0.4 to 1 GHz	dB	25	18	17
Isolation, L to I (min)	fL = 0.01 to 0.1 GHz	dB	45	35	34
	fL = 0.1 to 0.4 GHz	dB	35	25	24
	fL = 0.4 to 1 GHz	dB	20	14	13
1 dB Conversion Comp.	fL = +25 dBm	dBm	+20		
Input IP3		dBm	+30		

* The M2EC specification limits apply at 0°C to +50°C.

1

ADVANCED: Data Sheets contain information regarding a product M/A-COM Technology Solutions is considering for development. Performance is based on target specifications, simulated results, and/or prototype measurements. Commitment to develop is not guaranteed.

PRELIMINARY: Data Sheets contain information regarding a product M/A-COM Technology Solutions has under development. Performance is based on engineering tests. Specifications are typical. Mechanical outline has been fixed. Engineering samples and/or test data may be available. Commitment to produce in volume is not guaranteed.

• **North America** Tel: 800.366.2266 • **Europe** Tel: +353.21.244.6400

• **India** Tel: +91.80.4155721

• **China** Tel: +86.21.2407.1588

Visit www.macomtech.com for additional data sheets and product information.

M/A-COM Technology Solutions Inc. and its affiliates reserve the right to make changes to the product(s) or information contained herein without notice.

Typical Performance Curves

Conversion Loss vs. Frequency

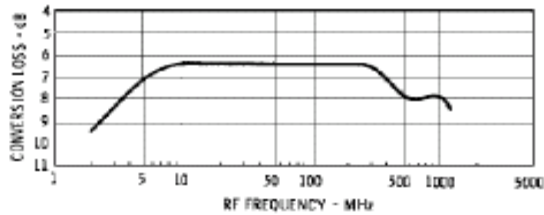

$f_{LO} = f_{RF}$
 $P_{LO} = +20 \text{ dBm}$
 $P_{RF} = -10 \text{ dBm}$
 $f_{IF} = \text{BETWEEN } 1 \text{ MHz and } 100 \text{ MHz}$

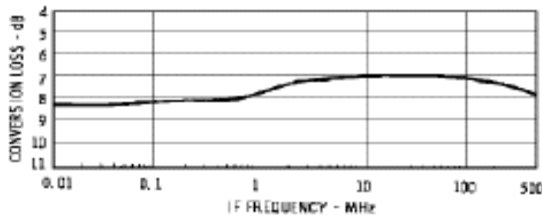

$f_{LO} > f_{RF}$
 $P_{LO} = +20 \text{ dBm}$
 $f_{RF} = 100 \text{ MHz @ } -10 \text{ dBm}$

Conversion Loss vs. LO Drive

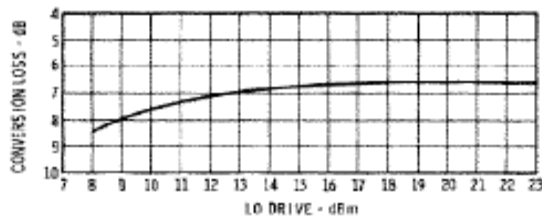

$f_{LO} = 400 \text{ MHz}$
 $f_{RF} = 300 \text{ MHz @ } -10 \text{ dBm}$

Isolation

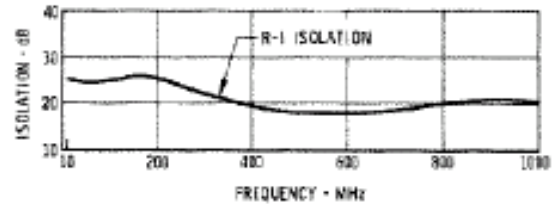
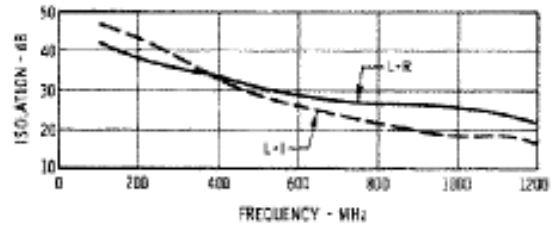

$f_{LO} = 700 \text{ MHz @ } +20 \text{ dBm}$
 $P_{RF} = -10 \text{ dBm}$

VSWR

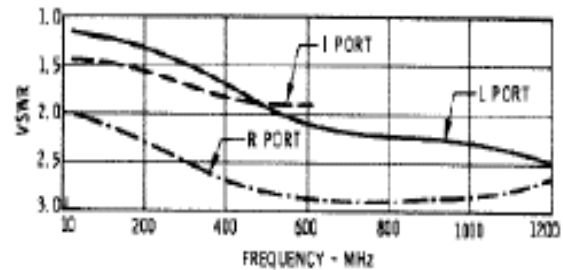

$P_{RF} = P_{IF} = -10 \text{ dBm}$
 $P_{LO} = +20 \text{ dBm}$
 $f_{LO} = 1000 \text{ MHz}$

Double-Balanced Mixer

Rev. V4

Absolute Maximum Ratings

Parameter	Absolute Maximum
Operating Temperature	-54°C to +100°C
Storage Temperature	-65°C to +100°C
Peak Input Power	+27 dBm max @ +25°C dBm max @ +100°C
Peak Input Current	100 mA DC

Outline Drawing: TO-8 *

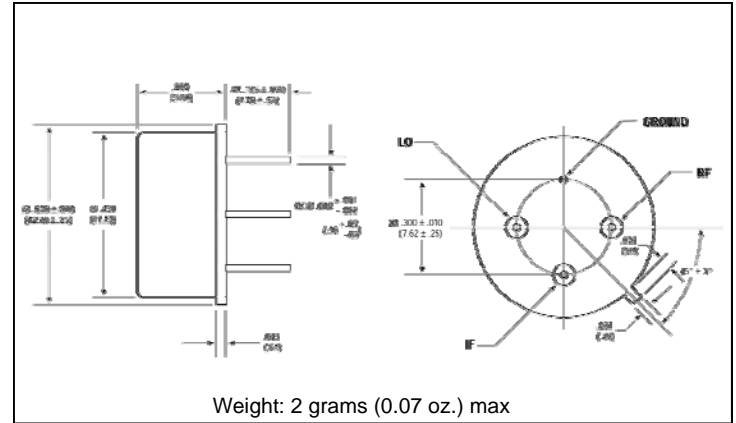

Outline Drawing: SMA Connectorized *

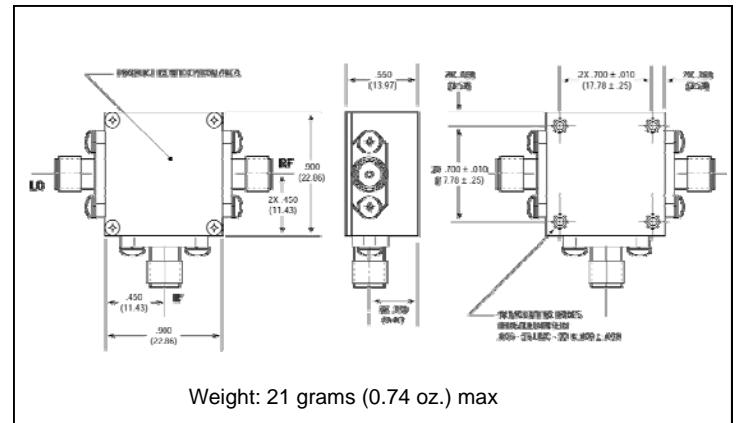

* Dimensions are inches (millimeters) ± 0.015 (0.38) unless otherwise specified.

Outline Drawing: Surface Mount *

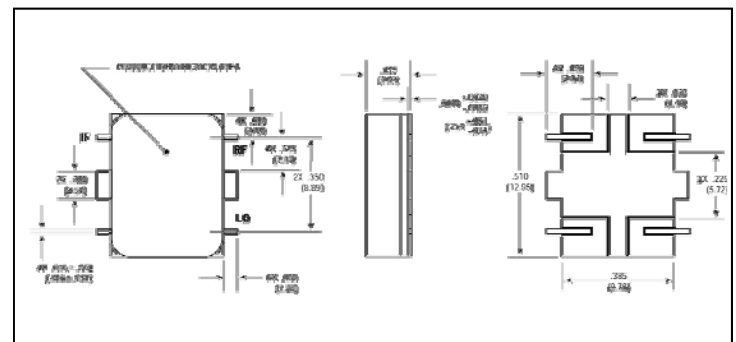

* Dimensions are inches (millimeters) ± 0.015 (0.38) unless otherwise specified.



Компания «ЭлектроПласт» предлагает заключение долгосрочных отношений при поставках импортных электронных компонентов на взаимовыгодных условиях!

Наши преимущества:

- Оперативные поставки широкого спектра электронных компонентов отечественного и импортного производства напрямую от производителей и с крупнейших мировых складов;
- Поставка более 17-ти миллионов наименований электронных компонентов;
- Поставка сложных, дефицитных, либо снятых с производства позиций;
- Оперативные сроки поставки под заказ (от 5 рабочих дней);
- Экспресс доставка в любую точку России;
- Техническая поддержка проекта, помощь в подборе аналогов, поставка прототипов;
- Система менеджмента качества сертифицирована по Международному стандарту ISO 9001;
- Лицензия ФСБ на осуществление работ с использованием сведений, составляющих государственную тайну;
- Поставка специализированных компонентов (Xilinx, Altera, Analog Devices, Intersil, Interpoint, Microsemi, Aeroflex, Peregrine, Syfer, Eurofarad, Texas Instrument, Miteq, Cobham, E2V, MA-COM, Hittite, Mini-Circuits, General Dynamics и др.);

Помимо этого, одним из направлений компании «ЭлектроПласт» является направление «Источники питания». Мы предлагаем Вам помощь Конструкторского отдела:

- Подбор оптимального решения, техническое обоснование при выборе компонента;
- Подбор аналогов;
- Консультации по применению компонента;
- Поставка образцов и прототипов;
- Техническая поддержка проекта;
- Защита от снятия компонента с производства.



Как с нами связаться

Телефон: 8 (812) 309 58 32 (многоканальный)

Факс: 8 (812) 320-02-42

Электронная почта: org@eplast1.ru

Адрес: 198099, г. Санкт-Петербург, ул. Калинина, дом 2, корпус 4, литера А.