



SANYO Semiconductors

DATA SHEET

An ON Semiconductor Company

CPH6003A — NPN Epitaxial Planar Silicon Transistor High-frequency Medium-power Amplifier Applications

Features

- High gain ($f_T=7\text{GHz}$ typ)
- High Current ($I_C=150\text{mA}$)
- Ultraminiature and thin 6pin package
- Large Collector Dissipation (800mW)

Specifications

Absolute Maximum Ratings at $T_a=25^\circ\text{C}$

Parameter	Symbol	Conditions	Ratings	Unit
Collector-to- Base Voltage	V_{CBO}		20	V
Collector-to-Emitter Voltage	V_{CEO}		12	V
Emitter-to-Base Voltage	V_{EBO}		2	V
Collector Current	I_C		150	mA
Collector Dissipation	P_C	When mounted on ceramic substrate (250mm ² ×0.8mm)	800	mW
Junction Temperature	T_j		150	°C
Storage Temperature	T_{stg}		-55 to +150	°C

Package Dimensions

unit : mm (typ)
7018A-002

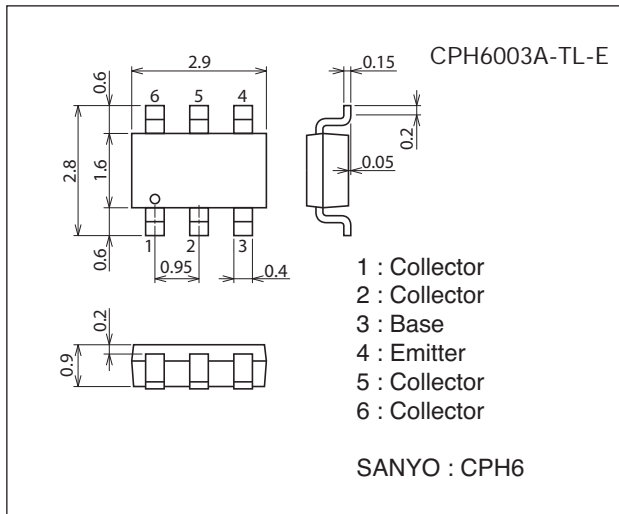

Product & Package Information

- Package : CPH6
- JEITA, JEDEC : SC-74, SOT-26, SOT-457
- Minimum Packing Quantity : 3,000 pcs./reel

Packing Type: TL

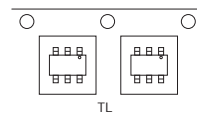

Marking

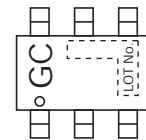

Electrical Connection

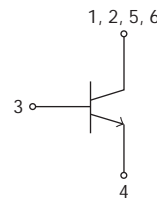

CPH6003A

Electrical Characteristics at Ta=25°C

Parameter	Symbol	Conditions	Ratings			Unit
			min	typ	max	
Collector Cutoff Current	ICBO	V _{CB} =10V, I _E =0A			1.0	μA
Emitter Cutoff Current	IEBO	V _{EB} =1V, I _C =0A			10	μA
DC Current Gain	h _{FE}	V _{CE} =5V, I _C =50mA	100		180	
Gain-Bandwidth Product	f _T			7		GHz
Output Capacitance	Cob	V _{CB} =10V, f=1MHz		1.3	2.0	pF
Reverse Transfer Capacitance	Cre			0.9		pF
Forward Transfer Gain	S _{21e} ²	V _{CE} =5V, I _C =50mA, f=1GHz		9		dB
Noise Figure	NF	V _{CE} =5V, I _C =50mA, f=1GHz		1.8	3.0	dB

Marking : GC Continued on next page

Ordering Information

Device	Package	Shipping	memo
CPH6003A-TL-E	CPH6	3,000pcs./reel	Pb Free

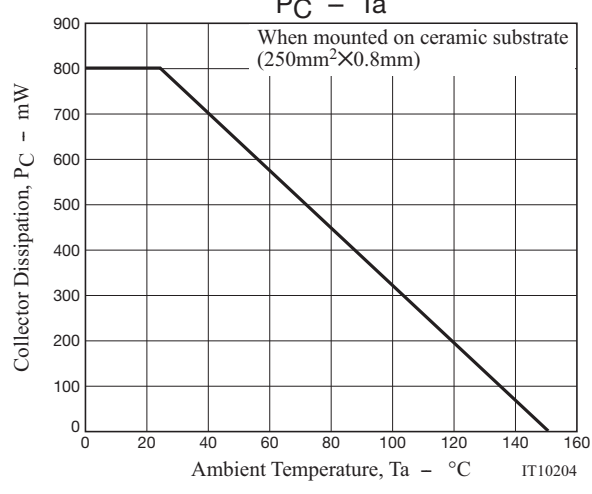
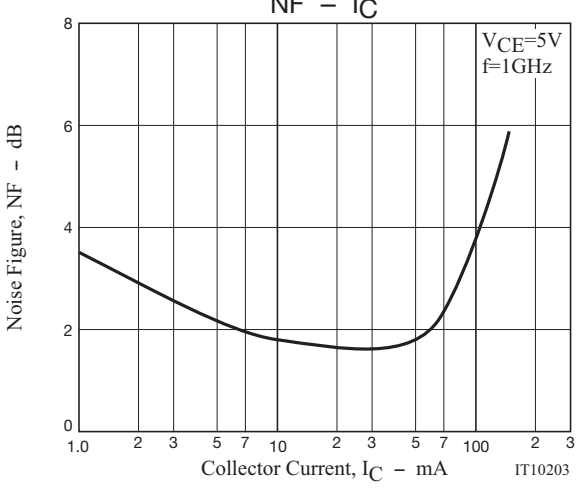
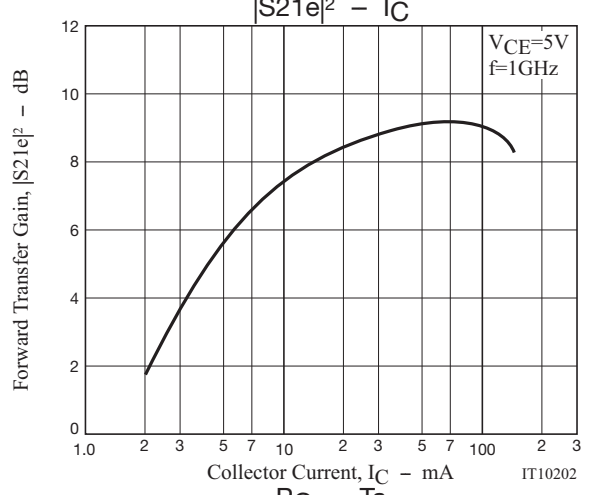
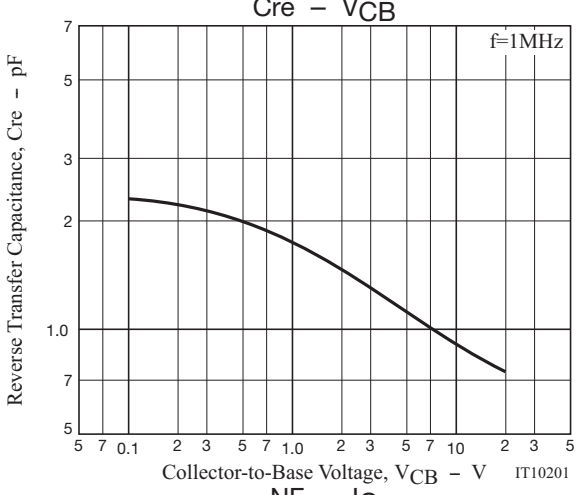
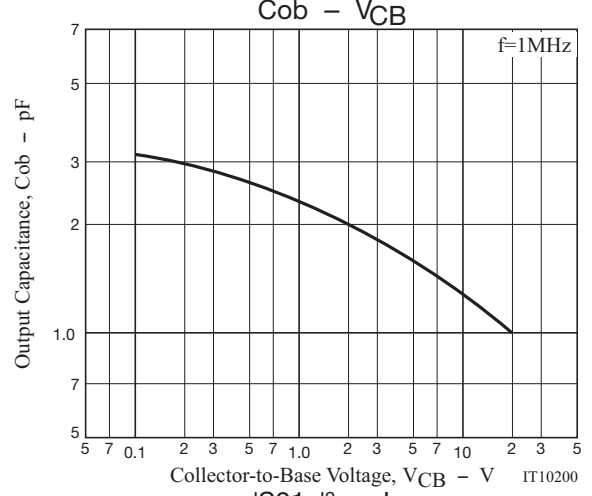
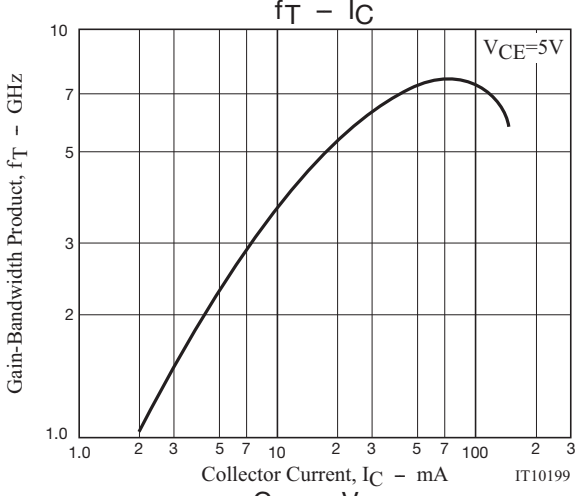
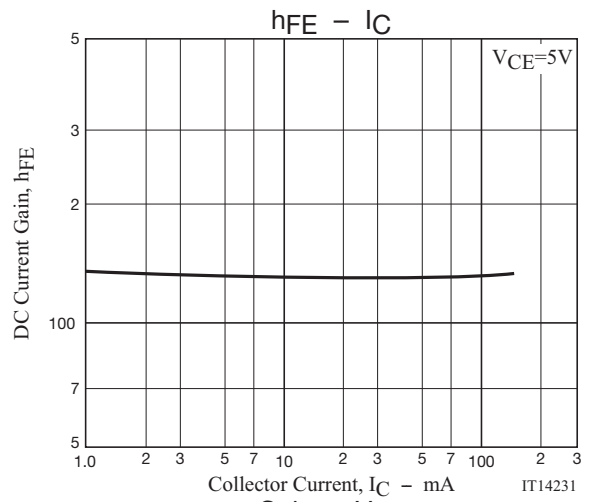
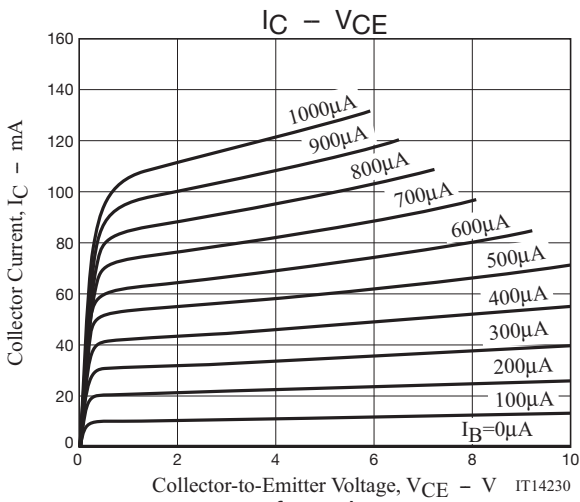

CPH6003A

S Parameters (Common emitter)

$V_{CE}=5V, I_C=20mA, Z_O=50\Omega$

Freq(MHz)	S ₁₁	∠S ₁₁	S ₂₁	∠S ₂₁	S ₁₂	∠S ₁₂	S ₂₂	∠S ₂₂
100	0.550	254.1	21.532	119.9	0.036	54.6	0.527	-62.8
200	0.492	218.1	12.273	103.0	0.050	56.5	0.332	-80.3
300	0.477	201.9	8.448	95.3	0.063	61.7	0.267	-88.3
400	0.470	192.4	6.427	90.4	0.078	65.3	0.242	268.1
500	0.518	181.0	5.015	86.8	0.089	68.2	0.217	245.3
600	0.513	175.8	4.221	83.9	0.104	70.2	0.216	245.8
700	0.510	171.5	3.658	81.3	0.120	71.7	0.214	247.2
800	0.508	167.6	3.234	78.9	0.135	72.7	0.220	249.3
900	0.503	163.7	2.900	76.7	0.150	73.2	0.225	251.3
1000	0.497	160.1	2.636	74.4	0.166	73.7	0.231	254.6
1100	0.493	156.8	2.419	72.5	0.181	73.9	0.239	256.3
1200	0.489	153.4	2.243	70.5	0.196	74.1	0.247	258.8

$V_{CE}=5V, I_C=50mA, Z_O=50\Omega$

Freq(MHz)	S ₁₁	∠S ₁₁	S ₂₁	∠S ₂₁	S ₁₂	∠S ₁₂	S ₂₂	∠S ₂₂
100	0.465	231.1	25.203	111.9	0.029	59.2	0.413	-79.9
200	0.449	203.4	13.519	98.7	0.045	65.7	0.269	259.6
300	0.445	191.6	9.177	92.7	0.061	70.4	0.230	250.7
400	0.443	184.2	6.947	88.8	0.078	72.8	0.218	247.3
500	0.502	175.0	5.407	86.1	0.092	74.7	0.231	224.3
600	0.497	170.3	4.550	83.7	0.110	75.6	0.229	225.5
700	0.494	166.4	3.944	81.5	0.127	76.2	0.225	227.1
800	0.490	162.8	3.483	79.4	0.144	76.4	0.228	229.9
900	0.485	159.1	3.127	77.4	0.161	76.2	0.230	232.4
1000	0.478	155.5	2.845	75.5	0.178	76.1	0.230	236.1
1100	0.473	152.3	2.608	73.6	0.195	75.9	0.236	238.6
1200	0.468	149.0	2.423	71.9	0.211	75.5	0.239	242.0

$V_{CE}=5V, I_C=100mA, Z_O=50\Omega$

Freq(MHz)	S ₁₁	∠S ₁₁	S ₂₁	∠S ₂₁	S ₁₂	∠S ₁₂	S ₂₂	∠S ₂₂
100	0.451	219.5	25.808	108.5	0.026	62.4	0.359	-86.7
200	0.448	196.7	13.593	96.8	0.043	69.8	0.240	253.1
300	0.448	187.0	9.193	91.4	0.060	73.8	0.212	244.9
400	0.446	180.7	6.953	87.8	0.078	75.5	0.205	242.3
500	0.508	172.6	5.408	85.5	0.093	76.9	0.228	219.9
600	0.503	168.3	4.550	83.1	0.110	77.5	0.226	221.5
700	0.500	164.6	3.944	81.0	0.128	77.8	0.223	223.4
800	0.497	161.2	3.480	79.0	0.145	77.8	0.226	226.5
900	0.490	157.6	3.132	77.0	0.163	77.4	0.228	229.1
1000	0.484	154.2	2.842	75.0	0.180	77.1	0.227	233.1
1100	0.479	151.0	2.614	73.3	0.197	76.7	0.232	235.8
1200	0.473	147.8	2.423	71.6	0.214	76.3	0.236	239.3

Embossed Taping Specification

CPH6003A-TL-E

1. Packing Format

Package Name	Carrier Tape Type	Maximum Number of devices contained (pcs)			Packing format	
		Reel	Inner box	Outer box	Inner BOX (C-1)	Outer BOX (A-7)
CPH6	CPH6	3,000	15,000	90,000	5 reels contained Dimensions:mm (external) 183×72×185	6 inner boxes contained Dimensions:mm (external) 440×195×210

Reel label, Inner box label
(unit:mm)

Outer box label

It is a label at the time of factory shipments.
The form of a label may change in physical distribution process.

Packing method

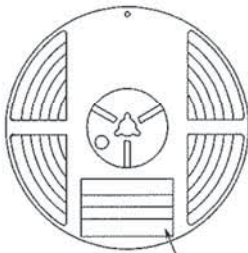

Reel label

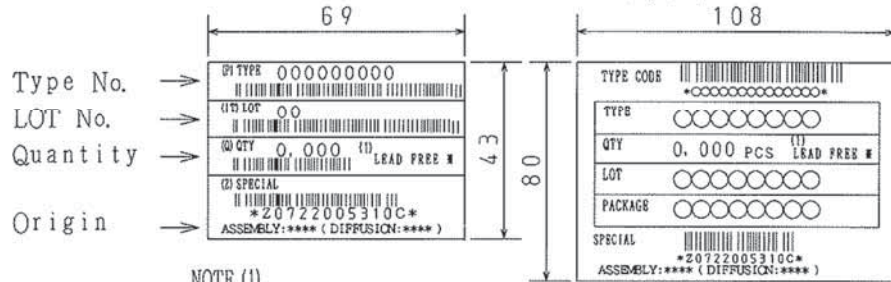

NOTE (1)

The LEAD FREE * description shows that the surface treatment of the terminal is lead free.

Label	JEITA Phase
LEAD FREE 3	JEITA Phase 3A
LEAD FREE 4	JEITA Phase 3

2. Taping configuration

2-1. Carrier tape size (unit:mm)

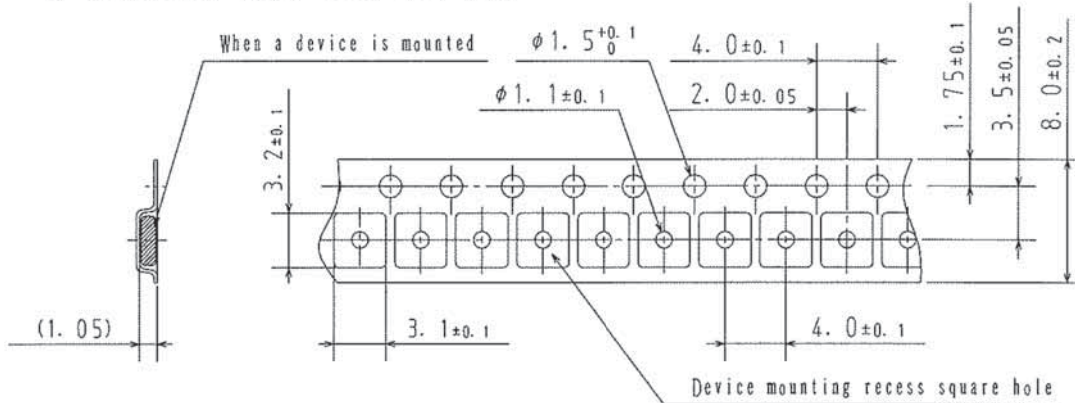

2-2. Device placement direction

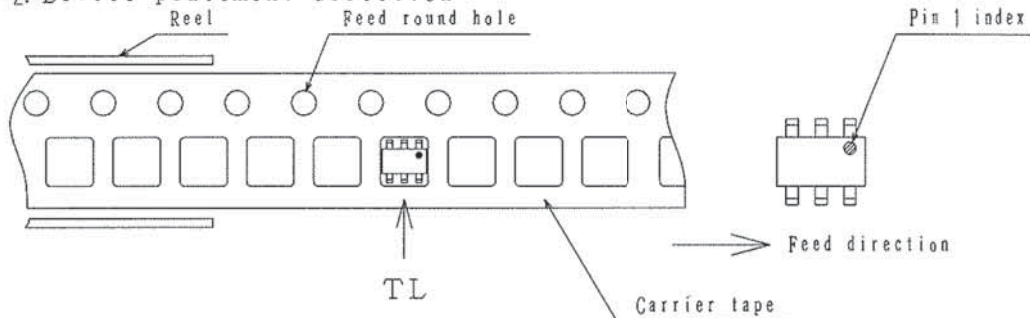

Those with pin 1 index on the feed hole side.....TL

CPH6003A

Outline Drawing CPH6003A-TL-E

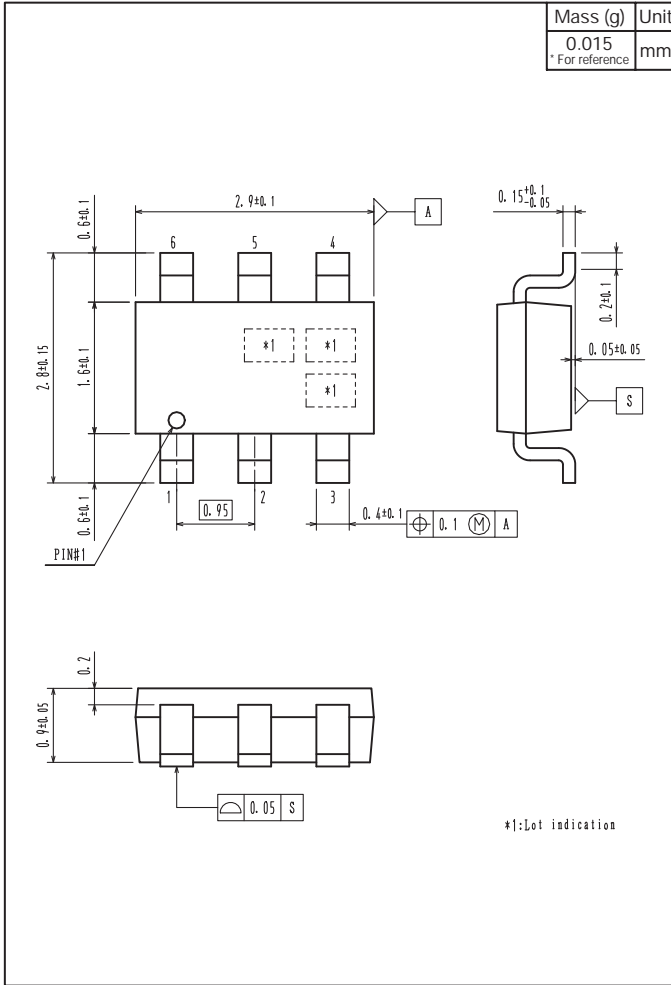

Land Pattern Example

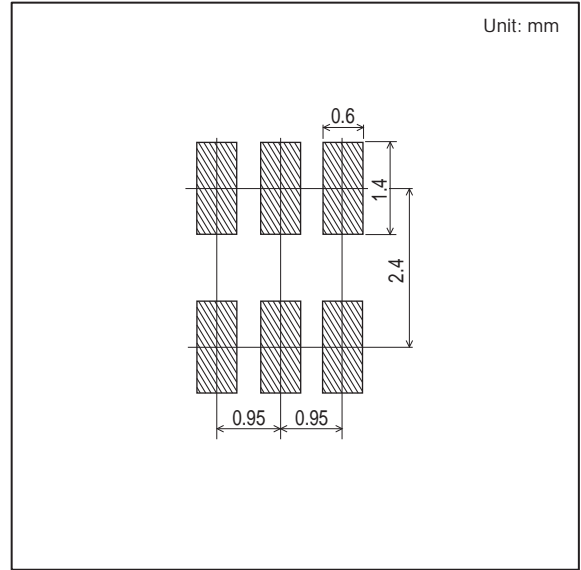

- Any and all SANYO Semiconductor Co.,Ltd. products described or contained herein are, with regard to "standard application", intended for the use as general electronics equipment. The products mentioned herein shall not be intended for use for any "special application" (medical equipment whose purpose is to sustain life, aerospace instrument, nuclear control device, burning appliances, transportation machine, traffic signal system, safety equipment etc.) that shall require extremely high level of reliability and can directly threaten human lives in case of failure or malfunction of the product or may cause harm to human bodies, nor shall they grant any guarantee thereof. If you should intend to use our products for new introduction or other application different from current conditions on the usage of automotive device, communication device, office equipment, industrial equipment etc. , please consult with us about usage condition (temperature, operation time etc.) prior to the intended use. If there is no consultation or inquiry before the intended use, our customer shall be solely responsible for the use.
- Specifications of any and all SANYO Semiconductor Co.,Ltd. products described or contained herein stipulate the performance, characteristics, and functions of the described products in the independent state, and are not guarantees of the performance, characteristics, and functions of the described products as mounted in the customer's products or equipment. To verify symptoms and states that cannot be evaluated in an independent device, the customer should always evaluate and test devices mounted in the customer's products or equipment.
- SANYO Semiconductor Co.,Ltd. assumes no responsibility for equipment failures that result from using products at values that exceed, even momentarily, rated values (such as maximum ratings, operating condition ranges, or other parameters) listed in products specifications of any and all SANYO Semiconductor Co.,Ltd. products described or contained herein.
- Regarding monolithic semiconductors, if you should intend to use this IC continuously under high temperature, high current, high voltage, or drastic temperature change, even if it is used within the range of absolute maximum ratings or operating conditions, there is a possibility of decrease reliability. Please contact us for a confirmation.
- SANYO Semiconductor Co.,Ltd. strives to supply high-quality high-reliability products, however, any and all semiconductor products fail or malfunction with some probability. It is possible that these probabilistic failures or malfunction could give rise to accidents or events that could endanger human lives, trouble that could give rise to smoke or fire, or accidents that could cause damage to other property. When designing equipment, adopt safety measures so that these kinds of accidents or events cannot occur. Such measures include but are not limited to protective circuits and error prevention circuits for safe design, redundant design, and structural design.
- In the event that any or all SANYO Semiconductor Co.,Ltd. products described or contained herein are controlled under any of applicable local export control laws and regulations, such products may require the export license from the authorities concerned in accordance with the above law.
- No part of this publication may be reproduced or transmitted in any form or by any means, electronic or mechanical, including photocopying and recording, or any information storage or retrieval system, or otherwise, without the prior written consent of SANYO Semiconductor Co.,Ltd.
- Any and all information described or contained herein are subject to change without notice due to product/technology improvement, etc. When designing equipment, refer to the "Delivery Specification" for the SANYO Semiconductor Co.,Ltd. product that you intend to use.
- Upon using the technical information or products described herein, neither warranty nor license shall be granted with regard to intellectual property rights or any other rights of SANYO Semiconductor Co.,Ltd. or any third party. SANYO Semiconductor Co.,Ltd. shall not be liable for any claim or suits with regard to a third party's intellectual property rights which has resulted from the use of the technical information and products mentioned above.

This catalog provides information as of June, 2012. Specifications and information herein are subject to change without notice.



Компания «ЭлектроПласт» предлагает заключение долгосрочных отношений при поставках импортных электронных компонентов на взаимовыгодных условиях!

Наши преимущества:

- Оперативные поставки широкого спектра электронных компонентов отечественного и импортного производства напрямую от производителей и с крупнейших мировых складов;
- Поставка более 17-ти миллионов наименований электронных компонентов;
- Поставка сложных, дефицитных, либо снятых с производства позиций;
- Оперативные сроки поставки под заказ (от 5 рабочих дней);
- Экспресс доставка в любую точку России;
- Техническая поддержка проекта, помощь в подборе аналогов, поставка прототипов;
- Система менеджмента качества сертифицирована по Международному стандарту ISO 9001;
- Лицензия ФСБ на осуществление работ с использованием сведений, составляющих государственную тайну;
- Поставка специализированных компонентов (Xilinx, Altera, Analog Devices, Intersil, Interpoint, Microsemi, Aeroflex, Peregrine, Syfer, Eurofarad, Texas Instrument, Miteq, Cobham, E2V, MA-COM, Hittite, Mini-Circuits, General Dynamics и др.);

Помимо этого, одним из направлений компании «ЭлектроПласт» является направление «Источники питания». Мы предлагаем Вам помощь Конструкторского отдела:

- Подбор оптимального решения, техническое обоснование при выборе компонента;
- Подбор аналогов;
- Консультации по применению компонента;
- Поставка образцов и прототипов;
- Техническая поддержка проекта;
- Защита от снятия компонента с производства.



Как с нами связаться

Телефон: 8 (812) 309 58 32 (многоканальный)

Факс: 8 (812) 320-02-42

Электронная почта: org@eplast1.ru

Адрес: 198099, г. Санкт-Петербург, ул. Калинина, дом 2, корпус 4, литера А.