

SECTION

1



SOCKET COMPATIBLE AND FLANGE MOUNTED RELAYS

1 TO 30 AMPERES



781

782

782H

783

784

750

788

283

388J/V

389/389F

300

9A/92

21

67

219

750H



781

MANUFACTURED UNDER
ISO 9002 QS 9000

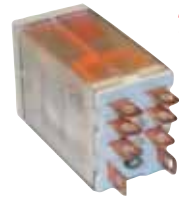

782XAX

MANUFACTURED UNDER
ISO 9002 QS 9000

PRODUCT

L X W X H (INCHES)

1.60 x 0.55 x 1.10

1.54 x 0.83 x 1.10

FEATURES

- ✦ 0.187 QUICK CONNECT/SOLDER PLUG-IN OR PRINTED CIRCUIT TERMINALS
 - ✦ FLAG INDICATOR
 - ✦ L.E.D. STATUS LAMP
 - ✦ PUSH BUTTON
 - ✦ FINGER GRIP COVER
 - ✦ I.D. TAG/WRITE LABEL
- ✦ OPTIONAL FLANGE AND DIN ADAPTERS
 - ✦ UL LISTED WHEN USED WITH 70-781D-1 SOCKET

- ✦ 0.187 QUICK CONNECT/SOLDER PLUG-IN OR PRINTED CIRCUIT TERMINALS
 - ✦ FLAG INDICATOR
 - ✦ L.E.D. STATUS LAMP
- ✦ PUSH BUTTON WITH LOCK DOWN DOOR
 - ✦ FINGER GRIP COVER
 - ✦ I.D. TAG/WRITE LABEL
- ✦ OPTIONAL FLANGE AND DIN ADAPTERS
 - ✦ UL LISTED WHEN USED WITH 70-459-1 OR 70-782D-1 SOCKETS

COIL

UNITS

Standard Voltage AC:	50/60 Hz	6, 12, 24, 110 / 120, 220 / 230, 240	6, 12, 24, 110 / 120, 220 / 230, 240
DC:		6, 12, 24, 48, 110 / 125	6, 12, 24, 48, 110 / 125
Coil Power AC (60 Hz):	VA	0.9	1.2
Coil Power DC:	W	0.7	0.9
Insulation System Per UL Standard 1446:		Class B (130°C)	Class B (130°C)

CONTACTS

Contact Configuration:		SPDT	SPDT
Contact Material:		Silver alloy, gold flashed	Silver alloy, gold flashed
Contact Resistance (Initial):	m Ohms	50	50
Contact Rating AC Amperes (AC1):	A	15	20
Contact Rating AC Voltage:	V	277	277
Contact Rating DC Amperes (DC1):	A	15 / 0.5	20 / 0.5
Contact Rating DC Voltage:	V	28 / 220	28 / 220
Horse Power (AC):	Hp	1/2 @ 120 V	1/2 @ 120 V
Horse Power (AC):	Hp	1 @ 250 V	1 @ 250 V

TIMING

Operate Time:	ms	20	25
Release Time:	ms	20	20

DIELECTRIC STRENGTH

Coil to Contacts:	V rms	2500	2500
Insulation Resistance:	megohms minimum@VDC	100 @ 500	1000 @ 500

TEMPERATURE

Operating, AC Lower:	°C	-40	-40
Operating, AC Upper:	°C	+70	+70
Operating, DC Lower:	°C	-40	-40
Operating, DC Upper:	°C	+70	+70
Storage, Lower:	°C	-40	-40
Storage, Upper:	°C	+105	+105

LIFE EXPECTANCY

Electrical @ Rated Load (AC1):	operations	15 A: 100,000, 20 A: 50,000	100,000
Mechanical @ no Load :	operations	10,000,000	10,000,000

MISCELLANEOUS

Cover Protection Category:	IP	40	40
Weight:	grams	29	36

MATING SOCKETS

SEE SECTION 7

70-781D-1, 70-781F-1, 70-781T-1

70-459-1, 70-782D-1, 70-401-1, 70-402-1

AGENCY APPROVALS



SOCKET COMPATIBLE & FLANGE MOUNT RELAYS



782XBX

MANUFACTURED UNDER
ISO 9002 QS 9000

1.54 x 0.83 x 1.10

- ◆ 0.187 QUICK CONNECT/SOLDER PLUG-IN OR PRINTED CIRCUIT TERMINALS
 - ◆ FLAG INDICATOR
 - ◆ L.E.D. STATUS LAMP
- ◆ PUSH BUTTON WITH LOCK DOWN DOOR
 - ◆ FINGER GRIP COVER
 - ◆ I.D. TAG/WRITE LABEL
- ◆ OPTIONAL FLANGE AND DIN ADAPTERS
 - ◆ UL LISTED WHEN USED WITH 70-459-1 OR 70-782D-1 SOCKETS



783XCX

MANUFACTURED UNDER
ISO 9002 QS 9000

1.54 x 1.21 x 1.10

- ◆ 0.187 QUICK CONNECT/SOLDER PLUG-IN OR PRINTED CIRCUIT TERMINALS
 - ◆ FLAG INDICATOR
 - ◆ L.E.D. STATUS LAMP
- ◆ PUSH BUTTON WITH LOCK DOWN DOOR
 - ◆ FINGER GRIP COVER
 - ◆ I.D. TAG/WRITE LABEL
- ◆ OPTIONAL FLANGE AND DIN ADAPTERS
 - ◆ UL LISTED WHEN USED WITH 70-783D-1 SOCKET



784DX

MANUFACTURED UNDER
ISO 9002 QS 9000

1.54 x 1.60 x 1.10

- ◆ 0.187 QUICK CONNECT/ SOLDER PLUG-IN OR PRINTED CIRCUIT TERMINALS
 - ◆ FLAG INDICATOR
- ◆ PUSH BUTTON WITH LOCK DOWN DOOR
 - ◆ FINGER GRIP COVER
 - ◆ I.D. TAG/WRITE LABEL
- ◆ OPTIONAL FLANGE AND DIN ADAPTERS
 - ◆ UL LISTED WHEN USED WITH 70-784D-1 SOCKET

6, 12, 24, 110 / 120, 220 / 230, 240
6, 12, 24, 48, 110 /125

1.2

0.9

Class B (130°C)

6, 12, 24,110 / 120, 220 / 230, 240
6, 12, 24, 48, 110 /125

1.7

1.5

CLASS B (130°C)

6, 12, 24,110 / 120, 220 / 230, 240
6, 12, 24, 48, 110 /125

2

1.5

Class B (130°C)

DPDT

Silver alloy, gold flashed

50

15 / 12

120 / 277

12 / 0.5

28 / 220

1/2 @ 120 V

1 @ 250 V

25

20

2500

1000 @ 500

-40

+70

-40

+70

-40

+105

200,000

10,000,000

40

36

70-459-1, 70-782D-1, 70-401-1, 70-402-1

3PDT

Silver alloy, gold flashed

50

15 / 12

120 / 277

15 / 0.5

28 / 220

1/2 @ 120 V

3/4 @ 250 V

25

20

2500

1000 @ 500

-40

+70

-40

+70

-40

+105

150,000

10,000,000

40

60

70-783D-1

4PDT

Silver alloy, gold flashed

50

15 / 12

120 / 277

15 / 0.5

28 / 220

1/2 @ 120 V

3/4 @ 250 V

20

20

2500

100 @ 500

-40

+70

-40

+70

-40

+105

150,000

10,000,000

40

80

70-784D-1





**782XBX1
& 782XDX1**

MANUFACTURED UNDER
ISO 9002 QS 9000



**782XBX2
& 782XDX2**

MANUFACTURED UNDER
ISO 9002 QS 9000

PRODUCT

L X W X H (INCHES)

1.54 x 0.83 x 1.10

1.54 x 0.83 x 1.10

FEATURES

- ✦ 0.100 QUICK CONNECT/ SOLDER PLUG-IN OR PRINTED CIRCUIT TERMINALS
 - ✦ FLAG INDICATOR
 - ✦ L.E.D. STATUS LAMP
 - ✦ PUSH BUTTON
 - ✦ FINGER GRIP COVER
 - ✦ I.D. TAG/WRITE LABEL
 - ✦ OPTIONAL FLANGE AND DIN ADAPTERS AVAILABLE
 - ✦ UL LISTED WHEN USED WITH 70-461-1 SOCKET

- ✦ 0.100 QUICK CONNECT/ SOLDER PLUG-IN OR PRINTED CIRCUIT TERMINALS
 - ✦ FLAG INDICATOR
 - ✦ L.E.D. STATUS LAMP
 - ✦ PUSH BUTTON WITH LOCK DOWN DOOR
 - ✦ FINGER GRIP COVER
 - ✦ I.D. TAG/WRITE LABEL
 - ✦ OPTIONAL FLANGE AND DIN ADAPTERS AVAILABLE
 - ✦ UL LISTED WHEN USED WITH 70-461-1 SOCKET

COIL

UNITS

Standard Voltage AC:	50/60 Hz	6, 12, 24, 110 / 120, 220 / 230, 240	6, 12, 24, 110 / 120, 220 / 230, 240
DC:		6, 12, 24, 48, 110 /125	6, 12, 24, 48, 110 /125
Coil Power AC (60 Hz):	VA	1.2	1.2
Coil Power DC:	W	0.9	0.9
Insulation System Per UL Standard 1446:		Class B (130°C)	Class B (130°C)

CONTACTS

Contact Configuration:		DPDT, 4PDT	DPDT, 4PDT
Contact Material:		Silver alloy, gold flashed	Silver alloy, gold flashed
Contact Resistance (Initial):	m Ohms	50	50
Contact Rating AC Amperes (AC1):	A	3	10 / 8.0
Contact Rating AC Voltage:	V	240	120 / 277
Contact Rating DC Amperes (DC1):	A	3 / 0.25	8 / 0.25
Contact Rating DC Voltage:	V	28 / 220	28 / 220
Horse Power (AC):	Hp		1/3 @ 120 V
Horse Power (AC):	Hp	1/10 @ 240 V	1 @ 277 V

TIMING

Operate Time:	ms	20	20
Release Time:	ms	20	20

DIELECTRIC STRENGTH

Coil to Contacts:	V rms	1500	1500
Insulation Resistance:	megohms minimum@VDC	100 @ 500	100 @ 500

TEMPERATURE

Operating, AC Lower:	°C	-40	-40
Operating, AC Upper:	°C	+70	+70
Operating, DC Lower:	°C	-40	-40
Operating, DC Upper:	°C	+70	+70
Storage, Lower:	°C	-40	-40
Storage, Upper:	°C	+105	+105

LIFE EXPECTANCY

Electrical @ Rated Load (AC1):	operations	200,000	200,000
Mechanical @ no Load :	operations	10,000,000	10,000,000

MISCELLANEOUS

Cover Protection Category:	IP	40	40
Weight:	grams	36	36

MATING SOCKETS

SEE SECTION 7

70-461-1, 70-378-1, 70-379-1

70-461-1, 70-378-1, 70-379-1

AGENCY APPROVALS



SOCKET COMPATIBLE & FLANGE MOUNT RELAYS

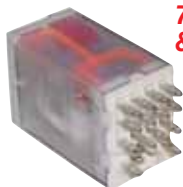

**782XBX3
& 782XDX3**

MANUFACTURED UNDER
ISO 9002 QS 9000

1.54 x 0.83 x 1.10

- ◆ 0.100 QUICK CONNECT/ SOLDER PLUG-IN OR PRINTED CIRCUIT TERMINALS
 - ◆ FLAG INDICATOR
 - ◆ L.E.D. STATUS LAMP
- ◆ PUSH BUTTON WITH LOCK DOWN DOOR
 - ◆ FINGER GRIP COVER
 - ◆ I.D. TAG/WRITE LABEL
 - ◆ OPTIONAL FLANGE AND DIN ADAPTERS AVAILABLE
- ◆ UL LISTED WHEN USED WITH 70-461-1 SOCKET

6, 12, 24, 110 / 120, 220 / 230, 240
6, 12, 24, 48, 110 /125

1.2

0.9

Class B (130°C)

DPDT, 4PDT

Silver alloy, gold flashed

50

3

240

3 / 0.25

28 / 220

1/16 @ 120 V

20

20

1500

100 @ 500

-40

+70

-40

+70

-40

+105

200,000

10,000,000

40

36

70-461-1, 70-378-1, 70-379-1



782H

CERTIFIED CLASS 1
DIVISION 2 FOR
HAZARDOUS LOCATIONS

MANUFACTURED UNDER
ISO 9001

1.28 x 0.91 x 1.15

- ◆ 0.100 SOLDER PLUG-IN TERMINALS
- ◆ HERMETICALLY SEALED VACUUM BAKED AND DRY NITROGEN FILLED
 - ◆ GRAY LACQUER FINISH OVER STEEL ENCLOSURE
- ◆ MEETS UL STANDARD FOR CLASS 1 DIVISION 2 HAZARDOUS LOCATIONS
 - ◆ OPTIONAL TOP OR SIDE STUD MOUNT
- ◆ UL LISTED WHEN USED WITH 70-461-1 SOCKET

6, 12, 24, 110 /120, 240
6, 12, 24, 48, 110 /125

1.2

0.9

Class B (130°C)

4PDT

See Table

50

1.0 / 3.0 / 5.0

240

1.0 / 3.0 / 5.0

28

13

6

1240

1000 @ 500

-40

+70

-40

+70

-40

+105

100,000

10,000,000

67

45

70-461-1, 70-378-1, 70-379-1



750

MANUFACTURED UNDER
ISO 9002 QS 9000

2.280 x 1.37 x 1.39

- ◆ 8 & 11 PIN OCTAL
- ◆ FLAG INDICATOR
- ◆ L.E.D. STATUS LAMP
- ◆ PUSH BUTTON WITH LOCK DOWN DOOR
 - ◆ FINGER GRIP COVER
 - ◆ I. D. TAG/WRITE LABEL
- ◆ UL LISTED WHEN USED WITH 70-464-1, 70-465-1, 70-750D8-1 OR 70-750D11-1 SOCKETS

6, 12, 24, 110 /120, 220/ 240
6, 12, 24, 48, 110 /125

2.0 - 3.0

1.4

Class B (130°C)

DPDT, 3PDT

Silver alloy, gold flashed

50

16

277

16 / 0.5

28 / 220

1/3 @ 120 V

1/2 @ 240 V

20

20

2500

1000 @ 500

-40

+50

-40

+65

-40

+105

100,000

5,000,000

40

89

70-464-1, 70-465-1, 70-750D8-1, 70-750D11-1
70-750EL, 70-750E, 70-750SL





788



MANUFACTURED UNDER ISO 9002 QS 9000



A283

MANUFACTURED UNDER ISO 9002 QS 9000

PRODUCT

L X W X H (INCHES)

2.15 x 1.37 x 1.39

1.90 x 1.53 x 1.40

FEATURES

- ✦ SOCKET OR FLANGE MOUNT
- ✦ FLAG INDICATOR
- ✦ L.E.D. STATUS LAMP
- ✦ PUSH BUTTON WITH LOCK DOWN DOOR
- ✦ FINGER GRIP COVER
- ✦ I. D. TAG/WRITE LABEL
- ✦ UL LISTED WHEN USED WITH 70-463-1 SOCKET

- ✦ SOCKET OR FLANGE MOUNT
- ✦ 0.187 QUICK CONNECT/ SOLDER PLUG-IN OR PRINTED CIRCUIT TERMINALS
- ✦ UL LISTED WHEN USED WITH 70-463-1 SOCKET

COIL

UNITS

Standard Voltage AC:	50/60 Hz	6,12, 24, 110 / 120, 220 / 240	6, 12, 24, 110 / 120, 220 / 240
DC:		6, 12, 24, 48, 110 / 125	6,12, 24, 48, 110 / 125
Coil Power AC (60 Hz):	VA	2.0 - 3.0	2.75
Coil Power DC:	W	1.4	2
Insulation System Per UL Standard 1446:		Class B (130°C)	Class B (130°C)

CONTACTS

Contact Configuration:		DPDT, 3PDT	SPST, DPDT, 3PDT
Contact Material:		Silver alloy, gold flashed	Silver alloy, gold flashed
Contact Resistance (Initial):	m Ohms	50	50
Contact Rating AC Amperes (AC1):	A	16	15
Contact Rating AC Voltage:	V	277	240
Contact Rating DC Amperes (DC1):	A	16 / 0.5	10
Contact Rating DC Voltage:	V	28 / 220	28
Horse Power (AC):	Hp	1/3 @ 120 V	1/3 @ 120 V
Horse Power (AC):	Hp	1/2 @ 240 V	1/2 @ 240 V

TIMING

Operate Time:	ms	20	20
Release Time:	ms	20	20

DIELECTRIC STRENGTH

Coil to Contacts:	V rms	2500	2500
Insulation Resistance:	megohms minimum@VDC	1000 @ 500	100 @ 500

TEMPERATURE

Operating, AC Lower:	°C	-40	-30
Operating, AC Upper:	°C	+50	+60
Operating, DC Lower:	°C	-40	-30
Operating, DC Upper:	°C	+65	+50
Storage, Lower:	°C	-40	-30
Storage, Upper:	°C	+105	+100

LIFE EXPECTANCY

Electrical @ Rated Load (AC1):	operations	100,000	100,000
Mechanical @ no Load :	operations	5,000,000	10,000,000

MISCELLANEOUS

Cover Protection Category:	IP	40	40
Weight:	grams	88	88

MATING SOCKETS
SEE SECTION 7

70-463-1, 70-124-1, 70-124-2, 70-178-1, 70-178-2,
70-788EL, 70-788SL

70-463-1, 70-124-1, 70-124-2, 70-178-1, 70-178-2,
70-788EL, 70-788SL

AGENCY APPROVALS



SOCKET COMPATIBLE & FLANGE MOUNT RELAYS

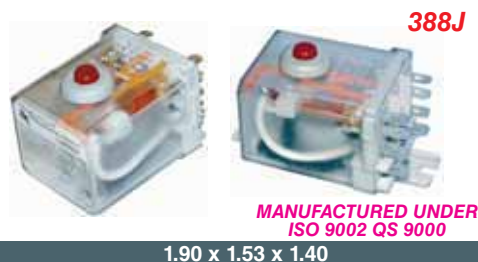

1.90 x 1.53 x 1.40

1.90 x 1.53 x 1.40

1.90 x 1.53 x 1.40

- ✦ SOCKET OR FLANGE MOUNT
- ✦ 0.187 QUICK CONNECT/ SOLDER PLUG-IN OR PRINTED CIRCUIT TERMINALS
- ✦ BLOW OUT MAGNET FOR SWITCHING DC VOLTAGES
- ✦ UL LISTED WHEN USED WITH 70-463-1 SOCKET

- ✦ SOCKET MOUNT OR FLANGE MOUNT
- ✦ ENLARGED 0.240 SILVER ALLOY CONTACTS FOR HIGH CURRENT
- ✦ 0.187 QUICK CONNECT / SOLDER PLUG-IN OR PRINTED CIRCUIT TERMINALS
- ✦ FLAG INDICATOR
- ✦ PUSH BUTTON
- ✦ UL LISTED WHEN USED WITH 70-463-1 SOCKET

- ✦ SOCKET MOUNT OR FLANGE MOUNT
- ✦ 3mm CONTACT GAP FOR HIGH VOLTAGE SWITCHING
- ✦ 0.187 QUICK CONNECT / SOLDER PLUG-IN OR PRINTED CIRCUIT TERMINALS
- ✦ 8mm SPACING
- ✦ PUSH BUTTON
- ✦ UL LISTED WHEN USED WITH 70-463-1 SOCKET

6, 12, 24, 110 / 120, 220 / 240
6,12, 24, 48, 110 / 125

6, 12, 24, 110 / 120, 220 / 240
6,12, 24, 48, 110 / 125

6, 12, 24, 110 / 120, 220 / 240
6,12, 24, 48, 110 / 125

2.75

2.75

2.75

2

2

2

Class B (130°C)

Class B (130°C)

Class B (130°C)

SPDT, DPDT

DPDT, 3PDT

DPDT-NO, 3PDT-NO

Silver alloy, gold flashed

Silver alloy, gold flashed

Silver alloy, gold flashed

50

50

50

15

2POLE: 20 / 3 POLE: 16

15

240

300 / 277

240

1POLE: 10, 2POLE: 3

20

15

150, 150

28

28

1/3 @ 120 V

See Table

1/3 @ 120 V

1/2 @ 240 V

See Table

1/2 @ 240 V

20

20

20

20

20

20

2000

2000

4000

100 @ 500

100 @ 500

100 @ 500

-30

-30

-30

+65

+65

+65

-30

-30

-30

+50

+50

+50

-30

-30

-30

+100

+100

+100

100,000

100,000

100,000

5,000,000

5,000,000

5,000,000

40

40

40

88

88

88

70-463-1, 70-124-1, 70-124-2, 70-178-1, 70-178-2
70-788EL, 70-788SL

70-463-1, 70-124-1, 70-124-2, 70-178-1, 70-178-2
70-788EL, 70-788SL

70-463-1, 70-124-1, 70-124-2, 70-178-1, 70-178-2
70-788EL, 70-788SL



PAGE 28, 29, 31



PAGE 32, 33



PAGE 32, 34



389

MANUFACTURED UNDER
ISO 9002 QS 9000



389F

MANUFACTURED UNDER
ISO 9002 QS 9000



300

MANUFACTURED UNDER
ISO 9002 QS 9000

PRODUCT

L X W X H (INCHES)

1.90 x 1.53 x 1.40

1.90 x 1.53 x 1.40

1.90 x 1.53 x 1.40

FEATURES

- ✦ FLANGE MOUNT
- ✦ 0.250 QUICK CONNECT/ SOLDER TERMINALS
- ✦ SWITCHING UP TO 30 AMPS
- ✦ SOCKET MOUNT AVAILABLE

- ✦ FLANGE MOUNT
- ✦ FLAG INDICATOR
- ✦ PUSH BUTTON
- ✦ SWITCHING UP TO 30 AMPS
- ✦ SOCKET MOUNT AVAILABLE

- ✦ FLANGE MOUNT
- ✦ 0.250 QUICK CONNECT SOLDER OR PRINTED CIRCUIT TERMINALS
- ✦ VARIETY OF MOUNTING OPTIONS AVAILABLE INCLUDING DIN, FLANGE AND STUD
- ✦ 2 MILLIMETER CONTACT GAP ARC BARRIER BETWEEN POLES
- ✦ OPTIONAL BLOWOUT MAGNET FOR HIGH VOLTAGE DC SWITCHING

COIL		UNITS			
Standard Voltage AC:		50/60 Hz	6, 12, 24, 110 / 120, 220 / 240	6, 12, 24, 110 / 120, 220 / 240	6, 12, 24, 110 / 120, 220 / 240
DC:			6,12, 24, 48, 110 / 125	6,12, 24, 48, 110 / 125	6,12, 24, 48, 110 / 125
Coil Power AC (60 Hz):	VA		3.5	3.5	3.0
Coil Power DC:	W		1.44	1.44	2.0
Insulation System Per UL Standard 1446:			Class B (130°C)	Class B (130°C)	Class B (130°C) or CClass F (155°C)
CONTACTS					
Contact Configuration:			DPDT-NO, 3PDT-NO	DPDT-NO, 3PDT-NO	DPDT
Contact Material:			Silver alloy, gold flashed	Silver alloy, gold flashed	Silver alloy, gold flashed
Contact Resistance (Initial):	m Ohms		50	50	50
Contact Rating AC Amperes (AC1):	A		20, 25, 30	20, 25, 30	30 / 20 / 15
Contact Rating AC Voltage:	V		See Table	See Table	277 / 480 / 600
Contact Rating DC Amperes (DC1):	A		See Table	See Table	30
Contact Rating DC Voltage:	V		See Table	See Table	28
Horse Power (AC):	Hp		See Table	See Table	1 @ 120
Horse Power (AC):	Hp		See Table	See Table	2 @ 208 -600
TIMING					
Operate Time:	ms		20	20	20
Release Time:	ms		20	20	15
DIELECTRIC STRENGTH					
Coil to Contacts:	V rms		1600	1600	4000
Insulation Resistance:	megohms minimum@VDC		1000 @ 500	1000 @ 500	1000 @ 500
TEMPERATURE					
Operating, AC Lower:	°C		-30	-30	-30
Operating, AC Upper:	°C		+65	+65	+60
Operating, DC Lower:	°C		-30	-30	-30
Operating, DC Upper:	°C		+50	+50	+50
Storage, Lower:	°C		-30	-30	-30
Storage, Upper:	°C		+100	+100	+100
LIFE EXPECTANCY					
Electrical @ Rated Load (AC1):	operations		100,000	100,000	100,000
Mechanical @ no Load :	operations		5,000,000	5,000,000	10,000,000
MISCELLANEOUS					
Cover Protection Category:	IP		40	40	40
Weight:	grams		88	88	85

MATING SOCKETS
SEE SECTION 7

70-788EL, 70-788SL

70-788EL, 70-788SL

AGENCY APPROVALS

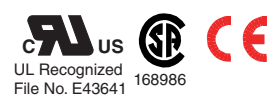
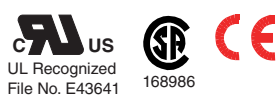

SOCKET COMPATIBLE & FLANGE MOUNT RELAYS



9A

1.980 x 1.08 x 1.10

- ✦ FLANGE MOUNT
- ✦ 0.250 SPADE TERMINALS ON CONTACTS AND 0.187 SPADE TERMINALS ON COIL ACCEPT INSULATED QUICK CONNECT CONNECTORS
- ✦ EPOXY SEALED IMMERSION CLEANABLE



92

MANUFACTURED UNDER ISO 9002 QS 9000

2.70 x 1.36 x 1.495

- ✦ DIN/ FLANGE MOUNT
- ✦ 0.250 SPADE TERMINALS ON CONTACTS AND 0.187 SPADE TERMINALS ON COIL ACCEPT INSULATED QUICK CONNECT CONNECTORS
- ✦ EPOXY SEALED IMMERSION CLEANABLE



21 / 136

MANUFACTURED UNDER ISO 9001

2.84 x 1.85 x 2.47

- ✦ TRAFFIC SIGNAL FLASH TRANSFER
- ✦ MEETS NEMA STD. TS 2-1992 D. O. T. APPROVED
- ✦ SWITCHES TUNGSTEN LOADS UP TO 20 AMPS
- ✦ MIDTEX 136 ALSO AVAILABLE

24, 120, 240
5, 12, 24, 48, 110 / 125

2.8

1

Class F (155°C)

24, 120, 240
5, 12, 24, 48, 110 / 125

4

1.7

Class F (155°C)

6, 12, 24, 110 / 120, 220 / 240
6, 12, 24, 48, 110 / 125

3.0

2.0

CLASS B (130°C)

SPST-NO. & SPDT

Silver alloy

75

30

240

30

28

1 @ 120 V

2 @ 240 V

20

20

2500

100 @ 500

-55

+85

-55

+85

-55

+105

100,000

10,000,000

40

33

DPST-NC. & DPDT

Silver alloy

75

30

277

20 7

28

1 @ 120 V

2 @ 240 V

20

20

2500

100 @ 500

-55

+85

-55

+85

-55

+105

100,000

5,000,000

40

86

DPDT

Silver alloy

100

30

240

20

28

1 1/2 @ 120 V

2 @ 240 V

20

20

1500

1000 @ 500

-40

+80

Not Applicable

Not Applicable

-40

+105

200,000

5,000,000

40

205

OPTIONAL DIN ADAPTER 16-9A DIN-1

70-TRF-8-1
70-TRB-8-1



PAGE 40, 41



PAGE 40, 42



PAGE 43



67



219

MANUFACTURED UNDER
ISO 9002 QS 9000



750H

PRODUCT

L X W X H (INCHES)

1.20 x 0.735 x 0.978 to 1.592

2.59 x 1.468 x 2.625 / 3.062

1.281 x 0.910 x 1.156

FEATURES

- ✦ 0.100 SOLDER PLUG-IN OR PRINTED CIRCUIT TERMINALS
- ✦ UP TO 6 POLES SWITCHING PLUG-IN STYLES HAVE 3-48 UNC
- ✦ GROUND STUDS
- ✦ OPTIONAL L 3 AMP BIFURCATED CONTACTS FOR LOW LEVEL

- ✦ 12 OR 14 PIN WITH LOCKING CLIP
- ✦ WIDE RANGE OF CONTACT CONFIGURATIONS TO 6PST
- ✦ WIDE CHOICE OF OPTIONS
- ✦ OPTIONAL 5 AMP BIFURCATED CONTACTS FOR LOW LEVEL
- ✦ UL LISTED WHEN USED WITH 27390D OR 33377D SOCKET
- ✦ NUCLEAR QUALIFIED VERSIONS AVAILABLE

- ✦ 8 & 11 PIN OCTAL BASE
- ✦ HERMETICALLY SEALED DRY NITROGEN FILLED
- ✦ GRAY LACQUER FINISH OVER STEEL ENCLOSURE
- ✦ MEETS UL STANDARD FOR CLASS 1 DIVISION 2 HAZARDOUS LOCATIONS
- ✦ UL LISTED WHEN USED WITH 70-464-1 OR 70-465-1 SOCKETS

COIL

UNITS

Standard Voltage AC:	50/60 Hz	110 / 120	6, 12, 24, 110 / 120, 220 / 240	12, 24, 110 / 120
DC:		5, 12, 24, 48, 110 / 125	6, 12, 24, 48, 110 / 125	12, 24, 110 / 125
Coil Power AC (60 Hz):	VA	2.75	1.2	2.0
Coil Power DC:	W	0.45	0.9	1.2
Insulation System Per UL Standard 1446:		Class B (130°C)	Class B (130°C)	Class B (130°C)

CONTACTS

Contact Configuration:		DPST to 6PDT	to 6PDT	DPDT, 3PDT
Contact Material:		Silver alloy, gold plated	Silver alloy, gold diffused	Silver alloy, gold flashed
Contact Resistance (Initial):	m Ohms	50	75	100
Contact Rating AC Amperes (AC1):	A	5 / 3	10 / 5	2 Pole-12, 3 Pole-10
Contact Rating AC Voltage:	V	120 / 120	120 / 120	120 / 240
Contact Rating DC Amperes (DC1):	A	5/3	10/5	10
Contact Rating DC Voltage:	V	28 / 28	28 / 28	30
Horse Power (AC):	Hp	-	See Table	1/3 @ 120 V
Horse Power (AC):	Hp	-	See Table	1/2 @ 240 V

TIMING

Operate Time:	ms	25	25	10
Release Time:	ms	20	20	30

DIELECTRIC STRENGTH

Coil to Contacts:	V rms	1500	1500	1250
Insulation Resistance:	megohms minimum@VDC	1000 @ 500	1000 @ 500	1000 @ 500

TEMPERATURE

Operating, AC Lower:	°C	-40	-40	-45
Operating, AC Upper:	°C	+60	+80	+55
Operating, DC Lower:	°C	-40	-40	-45
Operating, DC Upper:	°C	+60	+80	+70
Storage, Lower:	°C	-40	-40	-45
Storage, Upper:	°C	+130	+130	+105

LIFE EXPECTANCY

Electrical @ Rated Load (AC1):	operations	100,000	100,000	100,000
Mechanical @ no Load :	operations	10,000,000	10,000,000	5,000,000

MISCELLANEOUS

Cover Protection Category:	IP	40	40	67
Weight:	grams	22 to 40	241	130

MATING SOCKETS
SEE SECTION 7

70-303-1, 70-305-1, 70-307-1
70-304-1, 70-306-1, 70-308-1

27390D, 33377D

70-464-1, 70-465-1
70-750D8-1, 70-750D11-1

AGENCY APPROVALS



PAGE 44, 45



PAGE 46, 47



PAGE 48, 49

HOW TO CHOOSE A PLUG-IN RELAY



**SPDT
(XAX)**



781
20 AMPS
PAGE 14

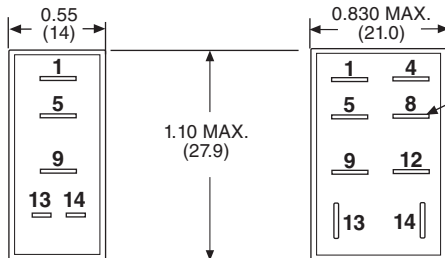

TYPICAL TERMINAL
SIZE IN INCHES:
0.187 X 0.020 (LONG)

782
20 AMPS
PAGE 15

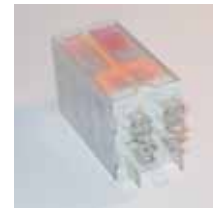

**DPDT
(XBX)**



782
15 AMPS
PAGE 16

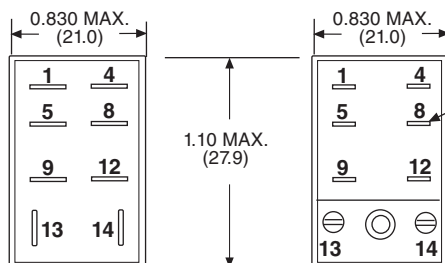

TYPICAL TERMINAL
SIZE IN INCHES:
0.110 X 0.020 (SHORT)

782
UP TO 10 AMPS
PAGE 21



**3PDT
(XCX)**



783
15 AMPS
PAGE 17

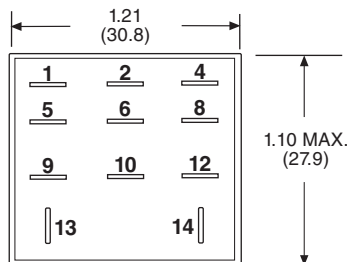

**4PDT
(XDX)**



784
15 AMPS
PAGE 18

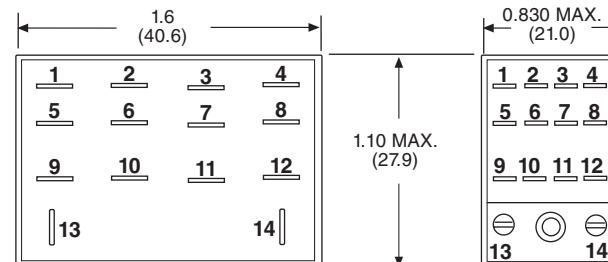

782
UP TO 10 AMPS
PAGE 21



**DPDT
(XBX)**



788
16 AMPS
PAGE 27

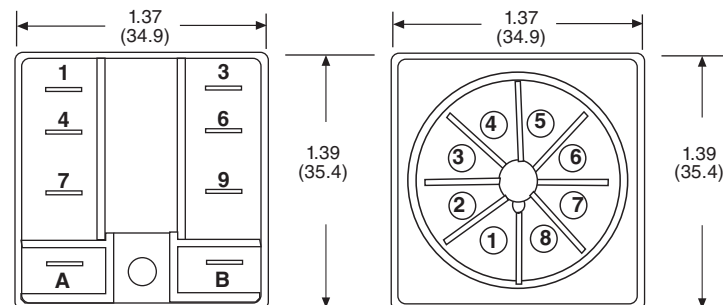

750
16 AMPS
PAGE 25



**3PDT
(XCX)**



788
16 AMPS
PAGE 27

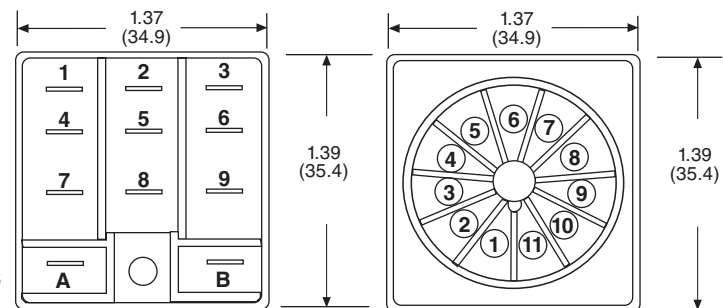

750
16 AMPS
PAGE 25



FEATURES

BENEFITS

FLAG INDICATOR:

SHOWS RELAY STATUS IN MANUAL OR POWERED CONDITION.

BI - POLAR L.E.D. STATUS LAMP:

ALLOWS FOR REVERSE POLARITY APPLICATIONS, SHOWS COIL "ON" OR "OFF" STATUS. IDEAL IN LOW LIGHT CONDITIONS.

COLOR CODED PUSH BUTTON:

IDENTIFIES AC COILS WITH RED OR DC COILS WITH BLUE PUSH BUTTONS. ALLOWS FOR MANUAL OPERATION OF RELAY WITHOUT THE NEED FOR COIL POWER. IDEAL FOR FIELD SERVICE PERSONNEL TO TEST CONTROL CIRCUITS.

LOCK-DOWN DOOR:

WHEN ACTIVATED, HOLDS PUSH BUTTON AND CONTACTS IN THE OPERATE POSITION. EXCELLENT FOR ANALYZING CIRCUIT PROBLEMS.

FINGER - GRIP COVER:

ALLOWS OPERATOR TO REMOVE RELAYS FROM SOCKETS MORE EASILY THAN CONVENTIONAL RELAYS.

WHITE PLASTIC I.D. TAG/WRITE LABEL:

USED FOR IDENTIFICATION OF RELAYS IN MULTI-RELAY CIRCUITS.

COVER ADAPTERS:

DIN RAIL ADAPTER OR TOP/BOTTOM FLANGE ADAPTER, ALLOWS THE 700 RELAYS TO BE DIRECT MOUNTED TO A DIN RAIL OR PANEL.



UL Recognized
File No. E43641



40787



COMPLIES WITH REQUIREMENTS OF

* IEC STANDARDS 947-4-1 AND 947-5-1 LOW VOLTAGE DIRECTIVE

* IEC = INTERNATIONAL ELECTROTECHNICAL COMMISSION

* CE TESTING AND EVALUATION PERFORMED BY THE UNDERWRITERS LABORATORIES AS A THIRD PARTY PARTICIPANT



LISTED 367G
IND. CONT. EQ.

WHEN USED WITH SOCKETS:

781:70-781D-1

782:70-782D-1

70-459-1

70-461-1

783:70-783D-1

784:70-784D-1

CURRENT LIMITED TO RATING OF RELAY OR SOCKET WHICHEVER IS LESS

MANUFACTURED UNDER ISO 9002 & QS 9000

781
SPDT
15 AMPS



782
SPDT
20 AMPS
DPDT
15 AMPS



783
3PDT
15 AMPS



784
4PDT
15 AMPS



DIN ADAPTER
16-781C

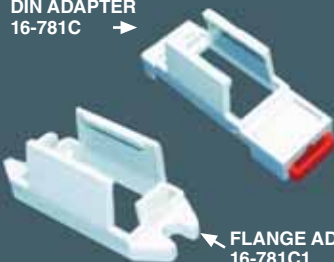

DIN ADAPTER
16-782C

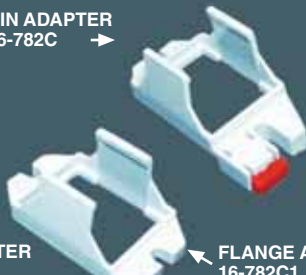

DIN ADAPTER
16-783C

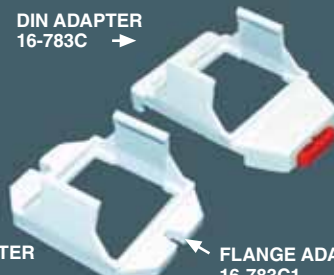

DIN ADAPTER
16-784C

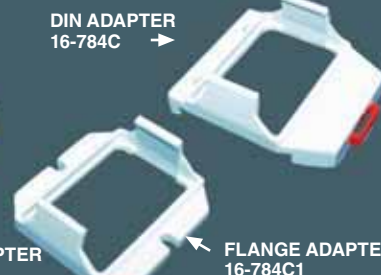

FLANGE ADAPTER
16-781C1

FLANGE ADAPTER
16-782C1

FLANGE ADAPTER
16-783C1

FLANGE ADAPTER
16-784C1

OPTIONAL ADAPTERS ORDERED SEPARATELY





GENERAL SPECIFICATIONS (@ 25°C)

	UNITS	781XAX	782XAX	782XBX	783	784
COIL						
Pull-in Voltage AC (50/60 Hz):≤	% of nominal	85	85	85	85	85
Pull-in Voltage DC:≤	% of nominal	80	80	80	80	80
Dropout Voltage AC (50/60 Hz):≥	% of nominal	10	10	10	10	10
Dropout Voltage DC:≥	% of nominal	10	10	10	10	10
Maximum Voltage:	% of nominal	110	110	110	110	110
Resistance:	% ±	15	15	15	15	15
Coil Power AC (60 Hz):	VA	0.9	1.2	1.2	1.5	1.5
Coil Power DC:	W	0.7	0.9	0.9	1.7	2
Insulation System Per UL Standard 1446:		Class B (130 °C)	Class B (130 °C)	Class B (130 °C)	Class B (130 °C)	Class B (130 °C)
Maximum Coil Dissipation, AC (60 Hz):	VA	2.55	2.55	2.55	3	3
Maximum Coil Dissipation, DC:	W	2.3	2.3	2.3	3.4	2.3
Duty:		Continuous	Continuous	Continuous	Continuous	Continuous
CONTACTS						
Contact Material:		Silver alloy, gold flashed	Silver alloy, gold flashed	Silver alloy, gold flashed	Silver alloy, gold flashed	Silver alloy, gold flashed
Contact Rating AC Amperes (AC1):	A	15	20	15 / 12	15 / 12	15 / 12
Contact Rating AC Voltage:	V	277	277	120 / 277	120 / 277	120 / 277
Contact Rating DC Amperes (DC1):	A	15 / 0.5	20 / 0.5	12 / 0.5	15 / 0.5	15 / 0.5
Contact Rating DC Voltage:	V	28 / 220	28 / 220	28 / 220	28 / 220	28 / 220
General Purpose Rating (75%-80% pf):	A @ V	10 @ 240				
Horse Power (AC):	HP	1/2 @ 120 V	1/2 @ 120 V	1/2 @ 120 V	1/2 @ 120 V	1/2 @ 120 V
Horse Power (AC):	HP	1 @ 250 V	1 @ 250 V	1 @ 250 V	3/4 @ 250 V	3/4 @ 250 V
Pilot Duty (60 Hz):		B300	B300	B300	B300	B300
Utilization Category:	IEC	AC15	AC15	AC15	AC15	AC15
VA Rating Make:	VA	3600	3600	3600	3600	3600
VA Rating Break:	VA	360	360	360	360	360
Minimum Recommended Load:	ma	100 @ 5 VDC or 0.5 W	100 @ 5 VDC or 0.5 W	100 @ 5 VDC or 0.5 W	100 @ 5 VDC or 0.5 W	100 @ 5 VDC or 0.5 W
TIMING						
Operate Time:	ms	20	20	25	25	20
Release Time:	ms	20	20	20	20	20
DIELECTRIC STRENGTH						
Coil to Contacts:	V rms	2500	2500	2500	2500	2500
Across Open Contacts:	V rms	1500	1500	1000	1000	1000
Pole to Pole:	V rms			2500	2500	2500
Insulation Resistance:	megohms minimum @ VDC	100 @ 500	100 @ 500	100 @ 500	100 @ 500	100 @ 500
VIBRATION RESISTANCE						
Functional:	g's	10-55 Hz, 6 g's, 1mm double amplitude	10-55 Hz, 6g's 1mm double amplitude	10-55 Hz, 6g's 1mm double amplitude	10-55 Hz, 6g's 1mm double amplitude	10-55 Hz, 6g's 1mm double amplitude
SHOCK RESISTANCE						
Functional:	g's	10	10	10	10	10
TEMPERATURE						
Operating, AC Lower:	°C	-40	-40	-40	-40	-40
Operating, AC Upper:	°C	+70	+70	+70	+70	+70
Operating, DC Lower:	°C	-40	-40	-40	-40	-40
Operating, DC Upper:	°C	+70	+70	+70	+70	+70
Storage, Lower:	°C	-40	-40	-40	-40	-40
Storage, Upper:	°C	+105	+105	+105	+105	+105
LIFE EXPECTANCY						
Electrical @ Rated Load (AC1):	operations	15 A: 100,000 20 A: 50,000	100,000	200,000	150,000	150,000
Mechanical @ no Load :	operations	10,000,000	10,000,000	10,000,000	10,000,000	10,000,000
MISCELLANEOUS						
Operating Position:		Any	Any	Any	Any	Any
Insulation Material:	94V-0	Molded plastic	Molded plastic	Molded plastic	Molded plastic	Molded plastic
Enclosure Material:	94V-0	Polycarbonate	Polycarbonate	Polycarbonate	Polycarbonate	Polycarbonate
Cover Protection Category:	IP	40	40	40	40	40
Terminals:	Inch (mm)	0.187, 0.1, 0.08 x 0.020 (4.47, 2.54, 2.03 x 0.508)	0.187, 0.08 x 0.020 (4.47, 2.03 x 0.508)	0.187, 0.08 x 0.020 (4.47, 2.03 x 0.508)	0.187, 0.08 x 0.020 (4.47, 2.03 x 0.508)	0.187, 0.08 x 0.020 (4.47, 2.03 x 0.508)
Weight:	grams	29	36	36	60	80

781 - 1 POLE "ICE CUBE" POWER RELAY



SPDT, 15 AMPS

WIRING DIAGRAM (VIEWED FROM PIN END)

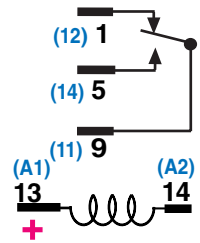

ALTERNATE NEMA
OR IEC () NUMBERS
VIEWED FROM
PIN SIDE

OUTLINE DIMENSIONS DIMENSIONS SHOWN IN INCHES & (MILLIMETERS).

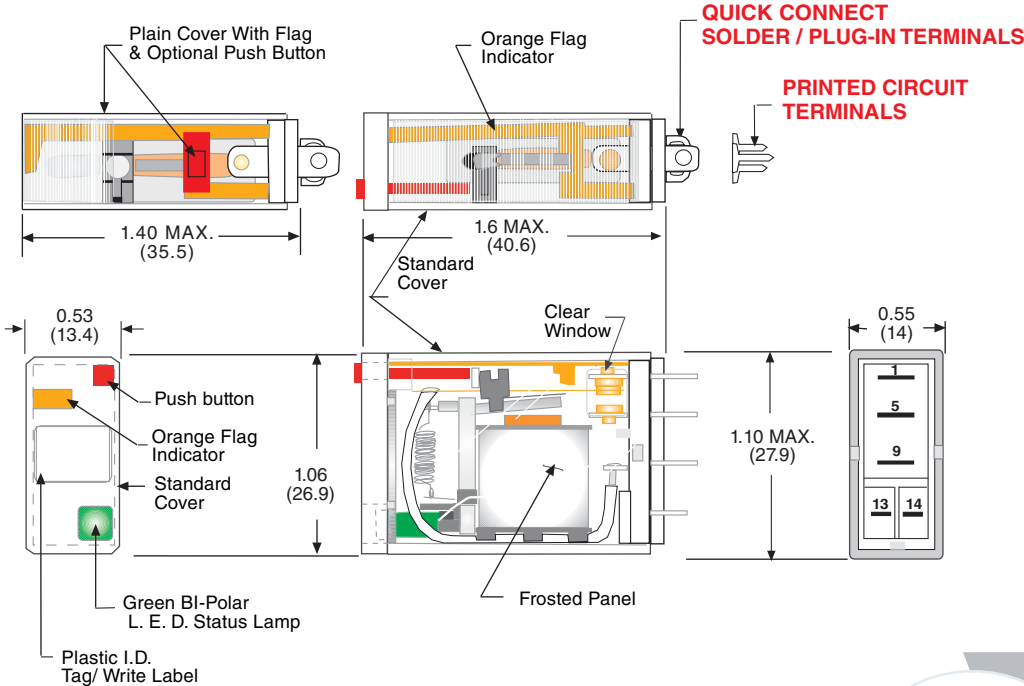

PRINTED CIRCUIT MOUNTING HOLE LAYOUT (TOP VIEW)

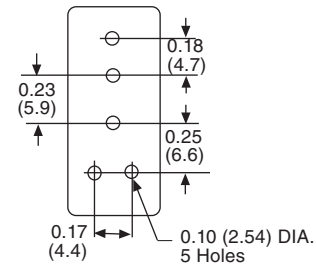

ORDERING CODE

781 **XAX** **ML** **-120A**

CLASS:

CONTACT CONFIGURATION:
SPDT: **XAX**

OPTIONAL PLAIN COVER:
CODE **C**

TERMINAL STYLE:
QUICK CONNECT SOLDER / PLUG-IN
TERMINALS: **NO CODE**
PRINTED CIRCUIT TERMINALS:
CODE **T**

FULL FEATURED VERSION:
PUSH BUTTON : CODE **M**
BI - POLAR L.E.D. STATUS LAMP: CODE **L**

OPTIONAL PLAIN COVER FEATURES:
PUSH BUTTON : CODE **M**
POLARIZED L.E.D. STATUS LAMP: CODE **L**
(OBSERVE POLARITY +)

COIL VOLTAGE:
6, 12, 24, 120, 220/230, 240 ADD "A" FOR AC COILS
6, 12, 24, 48, 110 ADD "D" FOR DC COILS



ALSO UL RATED 20 AMPS @ 277/28 DC - 50,000 OPERATIONS



Mating Sockets
70-781D-1: SCREW/DIN,
70-781F-1: SOLDER,
70-781T-1: PRINTED CIRCUIT
See section 7

FULL FEATURED	PLAIN COVER WITH FLAG	COIL MEASURED @ 25 °C	
		NOMINAL INPUT VOLTAGE	NOMINAL RESISTANCE (OHMS)
AC OPERATED - SOLDER/PLUG-IN, 15 AMP			
781XAXML-24A	781XAXC-24A	24 VAC, 50/60Hz	160 Ω
781XAXML-120A	781XAXC-120A	110/120 VAC, 50/60Hz	4,430 Ω
781XAXML-220/230A		220/230 VAC, 50/60HZ	15,720 Ω
781XAXML-240A		240 VAC, 50/60HZ	15,720 Ω
DC OPERATED - SOLDER/PLUG-IN, 15 AMP			
781XAXML-12D		12 VDC	180 Ω
781XAXML-24D	781XAXC-24D	24 VDC	750 Ω
781XAXML-110D		110/125 VDC	13,800 Ω
AC OPERATED - PRINTED CIRCUIT, 15 AMP			
781XAXTML-120A		110/120 VAC, 50/60Hz	4,430 Ω
DC OPERATED - PRINTED CIRCUIT, 15 AMP			
781XAXTML-12D		12 VDC	188 Ω
781XAXTML-24D		24 VDC	750 Ω

RETROFITS IDEC RH1B- & RH1V2-. SEE END OF SECTION 1 FOR CROSS REFERENCE CADMIUM-FREE CONTACTS AVAILABLE, CONTACT FACTORY FOR DETAILS

782/78 - 1 POLE "ICE CUBE" POWER RELAY



SPDT, 20 AMPS

WIRING DIAGRAM (VIEWED FROM PIN END)

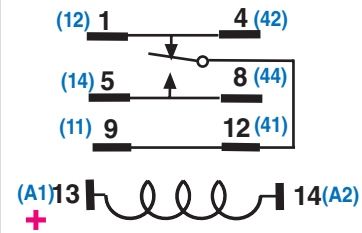

ALTERNATE NEMA
OR IEC () NUMBERS
VIEWED FROM
PIN SIDE

OUTLINE DIMENSIONS

DIMENSIONS SHOWN IN INCHES & (MILLIMETERS).

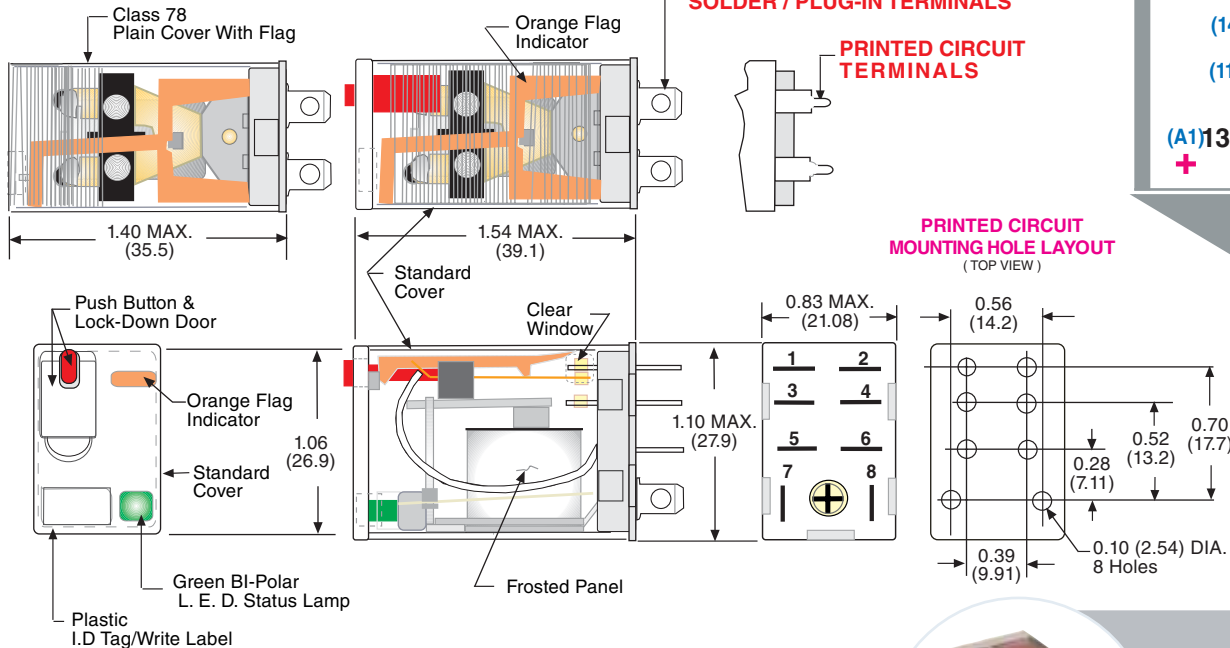

QUICK CONNECT SOLDER / PLUG-IN TERMINALS

PRINTED CIRCUIT TERMINALS

PRINTED CIRCUIT MOUNTING HOLE LAYOUT (TOP VIEW)



ORDERING CODE

782 **XAX** **M4L** **-120A**

CLASS:

CONTACT CONFIGURATION:
SPDT: **XAX**

OPTIONAL PLAIN COVER:
CODE **C**

TERMINAL STYLE:
QUICK CONNECTSOLDER/
PLUG-IN TERMINALS: **NO CODE**
PRINTED CIRCUIT TERMINALS: **CODE T**

FULL FEATURED VERSION:
PUSH BUTTON &
LOCK-DOWN DOOR: **CODE M4**
BI - POLAR L.E.D. STATUS LAMP: **CODE L**

OPTIONAL FULL FEATURED DELETION:
PUSH BUTTON WITHOUT
LOCK-DOWN DOOR: **CODE M**

OPTIONAL PLAIN COVER FEATURES:
PUSH BUTTON WITHOUT
LOCK-DOWN DOOR: **CODE M**
POLARIZED L.E.D. STATUS LAMP: **CODE L**
(OBSERVE POLARITY+)

COIL VOLTAGE:
6, 12, 24, 120, 220/230, 240 ADD "A" FOR AC COILS
6, 12, 24, 48, 110 ADD "D" FOR DC COILS

STANDARD PART NUMBERS

COIL MEASURED @ 25 °C

FULL FEATURED	PLAIN COVER WITH FLAG	NOMINAL INPUT VOLTAGE	NOMINAL RESISTANCE (OHMS)
AC OPERATED SOLDER/PLUG -IN, 20 AMP			
DUAL MARKED			
	NEW PART NUMBER	SUPERCEDES	
782XAXM4L-12A	782XAXC-12A	W78ARCSX-108	12 VAC, 50/60Hz 46 Ω
782XAXM4L-24A	782XAXC-24A	W78ARCSX-109	24 VAC, 50/60Hz 180 Ω
782XAXM4L-120A	782XAXC-120A	W78ARCSX-111	110/120 VAC, 50/60Hz 4,430 Ω
782XAXM4L-220/230A	782XAXC-220/230A		220/230VAC, 50/60Hz 15,000 Ω
782XAXM4L-240A	782XAXC-240A	W78ARCSX-112	240 VAC, 50/60HZ 15,700 Ω
DC OPERATED SOLDER/PLUG -IN, 20 AMP			
782XAXM4L-12D	782XAXC-12D	W78RCSX-97	12 VDC 160 Ω
782XAXM4L-24D	782XAXC-24D	W78RCSX-98	24 VDC 650 Ω
782XAXM4L-110D	782XAXC-110D	W78RCSX-100	110/125 VDC 13,800 Ω
AC OPERATED SOLDER/PLUG -IN, 20 AMP WITH STATUS LED LAMP			
	782XAXCL-24A	W78ARNCSX-8	24 VAC, 50/60Hz 180 Ω
	782XAXCL-120A	W78ARNCSX-9	110/120 VAC, 50/60Hz 4,430 Ω
	782XAXCL-240A	W78ARNCSX-10	240 VAC, 50/60HZ 15,700 Ω
DC OPERATED SOLDER/PLUG -IN, 20 AMP WITH STATUS LED LAMP			
	782XAXCL-24D	W78RNCSX-10	24 VDC 650 Ω
AC OPERATED PRINTED CIRCUIT TERMINALS, 20 AMP			
782XAXTM4L-12A	782XAXCT-12A	W78ARPCX-81	12 VAC, 50/60Hz 46 Ω
782XAXTM4L-24A	782XAXCT-24A	W78ARPCX-82	24 VAC, 50/60Hz 180 Ω
782XAXTM4L-120A	782XAXCT-120A	W78ARPCX-84	110/120 VAC, 50/60Hz 4,430 Ω
DC OPERATED PRINTED CIRCUIT TERMINALS, 20 AMP			
782XAXTM4L-12D	782XAXCT-12D	W78RPCX-79	12 VDC 160 Ω
782XAXTM4L-24D	782XAXCT-24D	W78RPCX-83	24 VDC 650 Ω
782XAXTM4L-110D	782XAXCT-110D	W78RPCX-85	110 /125 VDC 13,800 Ω

NOTE: CLASS 782C IS AN ENHANCED VERSION OF THE 78, IT HAS SUPERIOR RATINGS, A FLAG INDICATOR, & DISPLAYS BOTH PART NUMBERS.

782/78 - 2 POLE "ICE CUBE" POWER RELAYS



DPDT, 15 AMPS

WIRING DIAGRAM (VIEWED FROM PIN END)

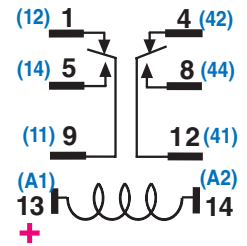

ALTERNATE NEMA
OR IEC () NUMBERS
VIEWED FROM
PIN SIDE

OUTLINE DIMENSIONS DIMENSIONS SHOWN IN INCHES & (MILLIMETERS).

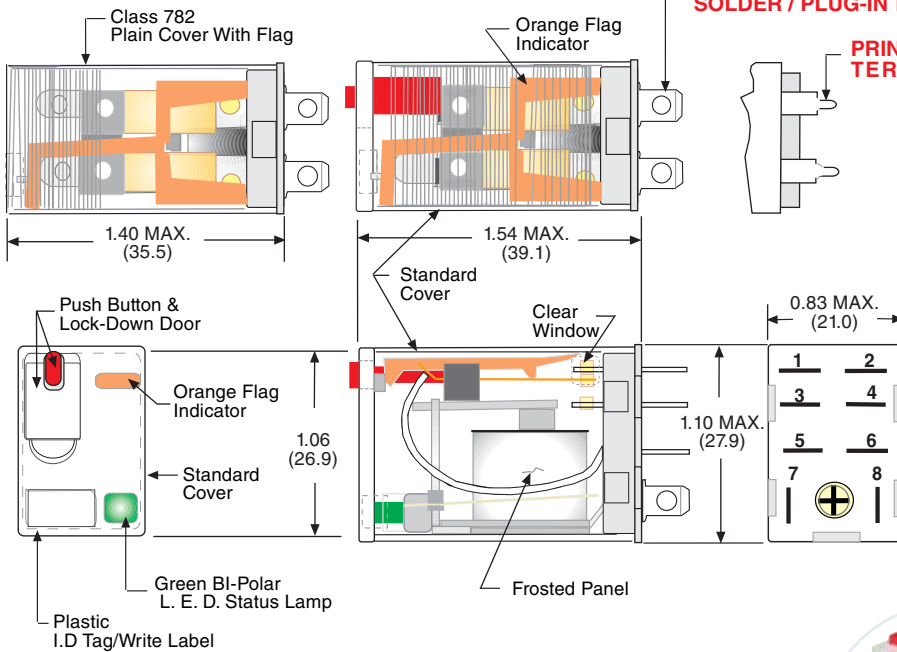

QUICK CONNECT SOLDER / PLUG-IN TERMINALS

PRINTED CIRCUIT TERMINALS

PRINTED CIRCUIT MOUNTING HOLE LAYOUT (TOP VIEW)

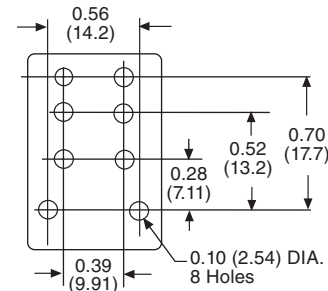

ORDERING CODE

782 **XBX** **M4L** **-120A**

CLASS: _____
CONTACT CONFIGURATION:
 DPDT: **XBX**
OPTIONAL PLAIN COVER:
 CODE **C**
TERMINAL STYLE:
 QUICK CONNECTSOLDER/
 PLUG-IN TERMINALS: **NO CODE**
 PRINTED CIRCUIT TERMINALS:
 CODE **T**

FULL FEATURED VERSION:
 PUSH BUTTON &
 LOCK-DOWN DOOR: **CODE M4**
 BI - POLAR L.E.D. STATUS LAMP: **CODE L**

OPTIONAL FULL FEATURED DELETION:
 PUSH BUTTON WITHOUT
 LOCK-DOWN DOOR: **CODE M**

OPTIONAL PLAIN COVER FEATURES:
 PUSH BUTTON WITHOUT
 LOCK-DOWN DOOR: **CODE M**
 POLARIZED L.E.D. STATUS LAMP: **CODE L**
 (OBSERVE POLARITY+)

COIL VOLTAGE: _____
 6, 12, 24, 120, 220/230, 240 ADD "A" FOR AC COILS
 6, 12, 24, 48, 110 ADD "D" FOR DC COILS



Mating Sockets
 70-782D-1, 70-459-1: SCREW/DIN
 70-402-1: PRINTED CIRCUIT
 70-401-1: SOLDER TERMINAL
 See section 7

STANDARD PART NUMBERS			COIL MEASURED @ 25°C	
FULL FEATURED	PLAIN COVER WITH FLAG		NOMINAL INPUT VOLTAGE	NOMINAL RESISTANCE (OHMS)
SOLDER/PLUG-IN, 15 AMP				
		DUAL MARKED		
		NEW PART NUMBER	SUPERCEDES	
		782XBXC-6A	W78ARCSX-7	6 VAC, 50/60Hz
782XBXM4L-24A	782XBXC-24A	W78ARCSX-9	24 VAC, 50/60Hz	180 Ω
782XBXM4L-120A	782XBXC-120A	W78ARCSX-11	110/120 VAC, 50/60Hz	4,430 Ω
782XBXM4L-220/230A			220/230 VAC, 50/60Hz	15,000 Ω
782XBXM4L-240A	782XBXC-240A	W78ARCSX-12	240 VAC, 50/60Hz	15,700 Ω
	782XBXC-6D	W78RCSX-6	6 VDC	40 Ω
782XBXM4L-12D	782XBXC-12D	W78RCSX-7	12 VDC	160 Ω
782XBXM4L-24D	782XBXC-24D	W78RCSX-8	24 VDC	650 Ω
	782XBXC-48D	W78RCSX-9	48 VDC	2600 Ω
782XBXM4L-110D	782XBXC-110D	W78RCSX-10	110/125 VDC	11,000 Ω
PRINTED CIRCUIT, 15 AMP				
	782XBXC-24A	W78ARPCX-3	24 VAC, 50/60Hz	180 Ω
	782XBXC-120A	W78ARPCX-6	110/120 VAC, 50/60Hz	4,430 Ω
	782XBXC-6D	W78RPCX-1	6 VDC	40 Ω
	782XBXC-12D	W78RPCX-2	12 VDC	160 Ω
	782XBXC-24D	W78RPCX-3	24 VDC	650 Ω

NOTE: CLASS 782C IS AN ENHANCED VERSION OF THE 78, IT HAS SUPERIOR RATINGS, A FLAG INDICATOR, & DISPLAYS BOTH PART NUMBERS.

783 - 3 POLE "ICE CUBE" POWER RELAY



3PDT, 15 AMPS

WIRING DIAGRAM (VIEWED FROM PIN END)

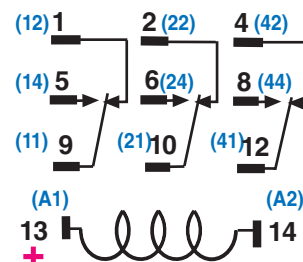

ALTERNATE NEMA OR IEC () NUMBERS VIEWED FROM PIN SIDE

OUTLINE DIMENSIONS DIMENSIONS SHOWN IN INCHES & (MILLIMETERS).

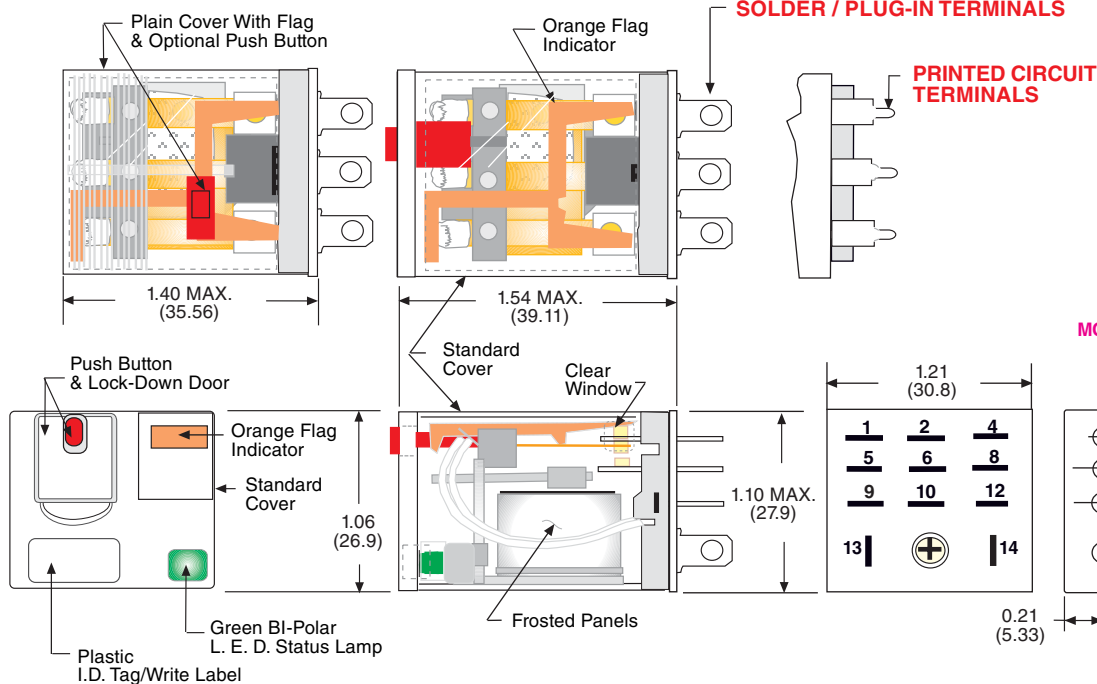

PRINTED CIRCUIT MOUNTING HOLE LAYOUT (TOP VIEW)

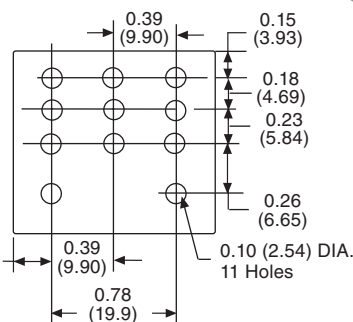

ORDERING CODE

783 **XCX** **M4L** **-120A**

CLASS:

CONTACT CONFIGURATION:

3PDT: **XCX**

OPTIONAL PLAIN COVER:

CODE **C**

TERMINAL STYLE:

QUICK CONNECT SOLDER / PLUG-IN TERMINALS: **NO CODE**

PRINTED CIRCUIT TERMINALS: **CODE T**

FULL FEATURED VERSION:

PUSH BUTTON & LOCK-DOWN DOOR: **CODE M4**
BI - POLAR L.E.D. STATUS LAMP: **CODE L**

OPTIONAL FULL FEATURED DELETION:

PUSH BUTTON WITHOUT LOCK-DOWN DOOR: **CODE M**
LOCK-DOWN DOOR: **CODE M**

OPTIONAL PLAIN COVER FEATURES:

PUSH BUTTON WITHOUT LOCK-DOWN DOOR: **CODE M**
POLARIZED L.E.D. STATUS LAMP: **CODE L**
(OBSERVE POLARITY+)

COIL VOLTAGE:

6, 12, 24, 120, 220/230, 240 **ADD "A" FOR AC COILS**
6, 12, 24, 48, 110 **ADD "D" FOR DC COILS**



Mating Socket
70-783D-1: SCREW/DIN
See section 7

FULL FEATURED	PLAIN COVER WITH FLAG	COIL MEASURED @ 25°C	
		NOMINAL INPUT VOLTAGE	NOMINAL RESISTANCE (OHMS)
AC OPERATED - SOLDER/PLUG-IN, 15 AMP			
783XCXM4L-24A	783XCXC-24A	24 VAC, 50/60 Hz	103 Ω
783XCXM4L-120A	783XCXC-120A	110/120 VAC, 50/60 Hz	2770 Ω
783XCXM4L-220/230A		220/230 VAC, 50/60 Hz	12,000 Ω
783XCXM4L-240A		240 VAC, 50/60 Hz	12,000 Ω
DC OPERATED - SOLDER/PLUG-IN, 15 AMP			
783XCXM4L-12D		12 VDC	100 Ω
783XCXM4L-24D	783XCXC-24D	24 VDC	400 Ω
783XCXM4L-110D		110/125 VDC	8600 Ω
AC OPERATED - PRINTED CIRCUIT, 15 AMP			
783XCXTM4L-120A		110/120 VAC, 50/60 Hz	2770 Ω
DC OPERATED - PRINTED CIRCUIT, 15 AMP			
783XCXTM4L-12D		12 VDC	100 Ω
783XCXTM4L-24D		24 VDC	400 Ω

RETROFITS IDEC RH3B- & RH3V2-
SEE END OF SECTION 1 FOR CROSS REFERENCE

784 - 4 POLE "ICE CUBE" POWER RELAY



4PDT, 15 AMPS

WIRING DIAGRAM (VIEWED FROM PIN END)

OUTLINE DIMENSIONS DIMENSIONS SHOWN IN INCHES & (MILLIMETERS).

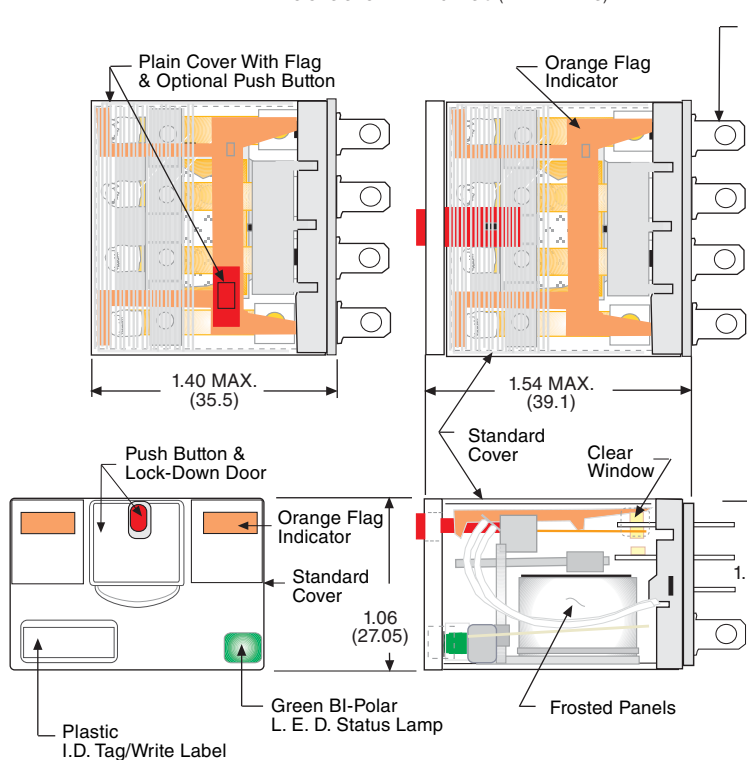

QUICK CONNECT SOLDER / PLUG-IN TERMINALS

PRINTED CIRCUIT TERMINALS

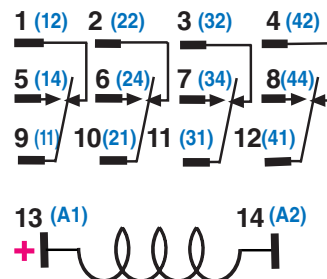

ALTERNATE NEMA
OR IEC () NUMBERS
VIEWED FROM
PIN SIDE

PRINTED CIRCUIT MOUNTING HOLE LAYOUT (TOP VIEW)

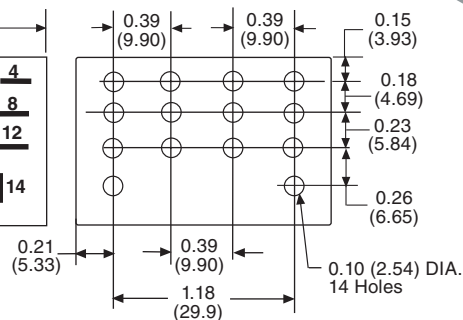

ORDERING CODE

784 XDX M4L -120A

CLASS: _____

CONTACT CONFIGURATION:
4PDT: XDX

OPTIONAL PLAIN COVER:
CODE C

TERMINAL STYLE:
QUICK CONNECT SOLDER / PLUG-IN
TERMINALS: NO CODE
PRINTED CIRCUIT TERMINALS: CODE T

FULL FEATURED VERSION:
PUSH BUTTON & LOCK-DOWN DOOR: CODE M4
BI - POLAR L.E.D. STATUS LAMP: CODE L

OPTIONAL FULL FEATURED DELETION:
PUSH BUTTON WITHOUT LOCK-DOWN DOOR:
CODE M

OPTIONAL PLAIN COVER FEATURES:
PUSH BUTTON WITHOUT LOCK-DOWN DOOR: CODE M
POLARIZED L.E.D. STATUS LAMP: CODE L
(OBSERVE POLARITY+)

COIL VOLTAGE:
6, 12, 24, 120, 220/230, 240 ADD "A" FOR AC COILS
6, 12, 24, 48, 110 ADD "D" FOR DC COILS



Mating Socket
70-784D-1: SCREW/DIN
See section 7

FULL FEATURED	PLAIN COVER WITH FLAG	COIL MEASURED @ 25 °C	
		NOMINAL INPUT VOLTAGE	NOMINAL RESISTANCE (OHMS)
AC OPERATED - SOLDER/PLUG-IN, 15 AMP			
784XDXM4L-24A	784XDXC-24A	24 VAC, 50/60 Hz	84.5 Ω
784XDXM4L-120A	784XDXC-120A	110/120 VAC, 50/60 Hz	2220 Ω
784XDXM4L-220/230A		220/230 VAC, 50/60 Hz	9120 Ω
784XDXM4L-240A		240 VAC, 50/60 Hz	9120 Ω
DC OPERATED - SOLDER/PLUG-IN, 15 AMP			
784XDXM4L-12D		12 VDC	96 Ω
784XDXM4L-24D	784XDXC-24D	24 VDC	388 Ω
784XDXM4L-110D		110/125 VDC	7340 Ω
AC OPERATED - PRINTED CIRCUIT, 15 AMP			
784XDXTM4L-120A		110/120 VAC, 50/60 Hz	2220 Ω
DC OPERATED - PRINTED CIRCUIT, 15 AMP			
784XDXTM4L-12D		12 VDC	96 Ω
784XDXTM4L-24D		24 VDC	388 Ω

RETROFITS IDEC RH4B- & RH4V2-
SEE END OF SECTION 1 FOR CROSS REFERENCE

FEATURES

BENEFITS

UL US
UL Recognized
File No. E43641 (782)
E209950 (782H)



COMPLIES WITH REQUIREMENTS OF

- * IEC STANDARDS 947-4-1 AND 947-5-1 LOW VOLTAGE DIRECTIVE
- * IEC = INTERNATIONAL ELECTROTECHNICAL COMMISSION
- * CE TESTING AND EVALUATION PERFORMED BY THE UNDERWRITERS LABORATORIES AS A THIRD PARTY PARTICIPANT



LISTED 367G
IND. CONT. EQ.

WHEN USED WITH
SOCKETS:
782: 70-461-1

CURRENT LIMITED
TO RATING OF
RELAY OR SOCKET
WHICHEVER IS LESS

FLAG INDICATOR:

SHOWS RELAY STATUS IN MANUAL OR POWERED CONDITION.

BI - POLAR L.E.D. STATUS LAMP:

ALLOWS FOR REVERSE POLARITY APPLICATIONS, SHOWS COIL "ON" OR "OFF" STATUS. IDEAL IN LOW LIGHT CONDITIONS.

COLOR CODED PUSH BUTTON:

IDENTIFIES AC COILS WITH RED OR DC COILS WITH BLUE PUSH BUTTONS. ALLOWS FOR MANUAL OPERATION OF RELAY WITHOUT THE NEED FOR COIL POWER. IDEAL FOR FIELD SERVICE PERSONNEL TO TEST CONTROL CIRCUITS.

LOCK-DOWN DOOR:

WHEN ACTIVATED, HOLDS PUSH BUTTON AND CONTACTS IN THE OPERATE POSITION. EXCELLENT FOR ANALYZING CIRCUIT PROBLEMS.

FINGER - GRIP COVER:

ALLOWS OPERATOR TO REMOVE RELAYS FROM SOCKETS MORE EASILY THAN CONVENTIONAL RELAYS.

WHITE PLASTIC I.D. TAG/WRITE LABEL:

USED FOR IDENTIFICATION OF RELAYS IN MULTI-RELAY CIRCUITS.

COVER ADAPTERS:

DIN RAIL ADAPTER OR TOP/BOTTOM FLANGE ADAPTER, ALLOWS THE 700 RELAYS TO BE DIRECT MOUNTED TO A DIN RAIL OR PANEL.

VACUUM BAKED & DRY NITROGEN FILLED (782H):

REMOVES CONTAMINANTS AND PROVIDES A CLEAN & DRY ATMOSPHERE FOR CONTACTS.

HERMETICALLY SEALED METAL ENCLOSURE (782H):

IDEAL FOR USE IN HAZARDOUS LOCATIONS. UL CERTIFIED FOR CLASS 1 DIVISION 2 GROUP A, B, C & D HAZARDS. WHEN RELAY IS USED WITH 70-461-1 SOCKET, THE HOLD-DOWN CLIP 16-1328 IS REQUIRED.

PLUG-IN STYLE OR SIDE MOUNTING STUD WITH ANTI- ROTATION TAB:

WHEN USED WITH 70-461-1 SOCKET THE 782H CAN BE DIN RAIL MOUNTED OR PANEL MOUNTED. THE SIDE STUD PROVIDES FOR DIRECT MOUNT & SOLDERED WIRE APPLICATIONS.

MANUFACTURED
UNDER
ISO 9002
& QS 9000

UL RATINGS FOR 782 HERMETICALLY SEALED

CONTACT CONFIGURATION	CURRENT OR HORSE POWER	LOAD VOLTAGE	LOAD VOLTAGE FREQUENCY	TYPE OF LOAD	MINIMUM LOAD
4PDT	1 AMP	120/240	50/60 Hz	RESISTIVE	DRY CIRCUIT
	3 AMP	120/240	50/60 Hz	RESISTIVE	100 mA 12 VAC
	5 AMP	120/240	50/60 Hz	RESISTIVE	500 mA 12 VAC
	1 AMP	30	DC	RESISTIVE	50 mA 5 VAC
	3 AMP	30	DC	RESISTIVE	100 mA 12 VDC
	5 AMP	30	DC	RESISTIVE	500 mA 12 VDC





GENERAL SPECIFICATIONS (@ 25°C)

	UNITS	782XBX1/782XDX1	782XBX2/782XDX2	782XBX3/782XDX3	782H
COIL					
Pull-in Voltage AC (50/60 Hz):≤	% of nominal	85	85	85	85
Pull-in Voltage DC:≤	% of nominal	80	80	80	80
Dropout Voltage AC (50/60 Hz):≥	% of nominal	10	10	10	10
Dropout Voltage DC:≥	% of nominal	10	10	10	10
Maximum Voltage:	% of nominal	110	110	110	110
Resistance:	% ±	15	15	15	15
Coil Power AC (60 Hz):	VA	1.2	1.2	1.2	1.2
Coil Power DC:	W	0.9	0.9	0.9	0.9
Insulation System Per UL Standard 1446:		Class B (130 °C)	Class B (130 °C)	Class B (130°C)	Class B (130°C)
Maximum Coil Dissipation, AC (60 Hz):	VA	2.55	2.55	2.55	2.5
Maximum Coil Dissipation, DC:	W	2.3	2.3	2.3	2
Duty:		Continuous	Continuous	Continuous	Continuous
CONTACTS					
Contact Material:		Silver alloy, gold flashed	Silver alloy, gold flashed	Silver alloy, gold flashed	Silver,gold plated,silver,gold flashed, silver alloy, gold, flashed, gold,silver,nickel
Contact Rating AC Amperes (AC1):	A	3	10 / 8.0	3	1.0 / 3.0 / 5.0
Contact Rating AC Voltage:	V	120 / 240	110/120 - 220/277	120 /240	120 / 240
Contact Rating DC Amperes (DC1):	A	3 / 0.25	8 / 0.25	3 / 0.25	1.0 / 3.0 / 5.0
Contact Rating DC Voltage:	V	28 / 220	28 / 220	28 / 220	28
Horse Power (AC):	HP	1/10 @ 120 V	1/3 @ 120 V	1/16 @ 120 V	
Horse Power (AC):	HP	1/10 @ 240 V	1 @ 277 V		
Pilot Duty (60 Hz):		B300	B300	B300	
Utilization Category:	IEC	AC15	AC15	AC15	AC15
VA Rating Make:	VA	1800	3600	1800	1800
VA Rating Break:	VA	180	360	180	180
Minimum Recommended Load:	ma	100 @ 5 VDC or 0.5 W	100 @ 5 VDC or 0.5 W	50 @ 5 VDC or 0.5 W	50/100 @ 5 VDC or 50 mw / 0.5 W
TIMING					
Operate Time:	ms	20	20	20	13
Release Time:	ms	20	20	20	6
DIELECTRIC STRENGTH					
Coil to Contacts:	V rms	1500	1500	1500	1240
Across Open Contacts:	V rms	1000	1000	1000	500
Pole to Pole:	V rms	1500	1500	1500	1240
Contacts to Frame:	V rms				1240
Insulation Resistance:	megohms minimum @VDC	100 @ 500	100 @ 500	100 @ 500	100 @ 500
VIBRATION RESISTANCE					
Functional:	g's	10-55 Hz, 6 g's,1 mm double amplitude	10-55 Hz, 6 g's,1 mm double amplitude	10-55 Hz, 6 g's,1 mm double amplitude	10-55 Hz, 6 g's,1 mm double amplitude
SHOCK RESISTANCE					
Functional:	g's	10	10	10	10
TEMPERATURE					
Operating, AC Lower:	°C	-40	-40	-40	-40
Operating, AC Upper:	°C	+70	+70	+70	+70
Operating, DC Lower:	°C	-40	-40	-40	-40
Operating, DC Upper:	°C	+70	+70	+70	+70
Storage, Lower:	°C	-40	-40	-40	-40
Storage, Upper:	°C	+105	+105	+105	+105
LIFE EXPECTANCY					
Electrical @ Rated Load (AC1):	operations	200,000	200,000	200,000	100,000
Mechanical @ no Load :	operations	10,000,000	10,000,000	10,000,000	10,000,000
MISCELLANEOUS					
Operating Position:		Any	Any	Any	Any
Insulation Material:	94V-0	Molded plastic	Molded plastic	Molded plastic	Molded plastic
Enclosure Material:	94V-0	Polycarbonate	Polycarbonate	Polycarbonate	Steel
Cover Protection Category:	IP	40	40	40	67
Terminals:	Inch (mm)	0.10 x 0.020 (2.54 x 0.508)	0.10 x 0.020 (2.54 x 0.508)	0.10 x 0.020 (2.54 x 0.508)	0.10 x 0.020 (2.54 x 0.508)
		0.040 x 0.020 (1.016 x 0.508)	0.040 x 0.020 (1.016 x 0.508)	0.040 x 0.020 (1.016 x 0.508)	
Weight:	grams	36	36	36	45

782 - 2 & 4 POLE "ICE CUBE" CONTROL RELAYS



DPDT & 4PDT 1, 3, 5 & 10 AMPS

WIRING DIAGRAM (VIEWED FROM PIN END)

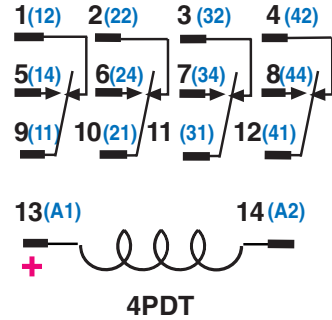
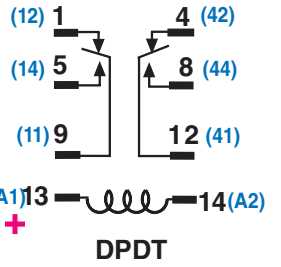

ALTERNATE NEMA
OR IEC () NUMBERS
VIEWED FROM
PIN SIDE

OUTLINE DIMENSIONS DIMENSIONS SHOWN IN INCHES & (MILLIMETERS).

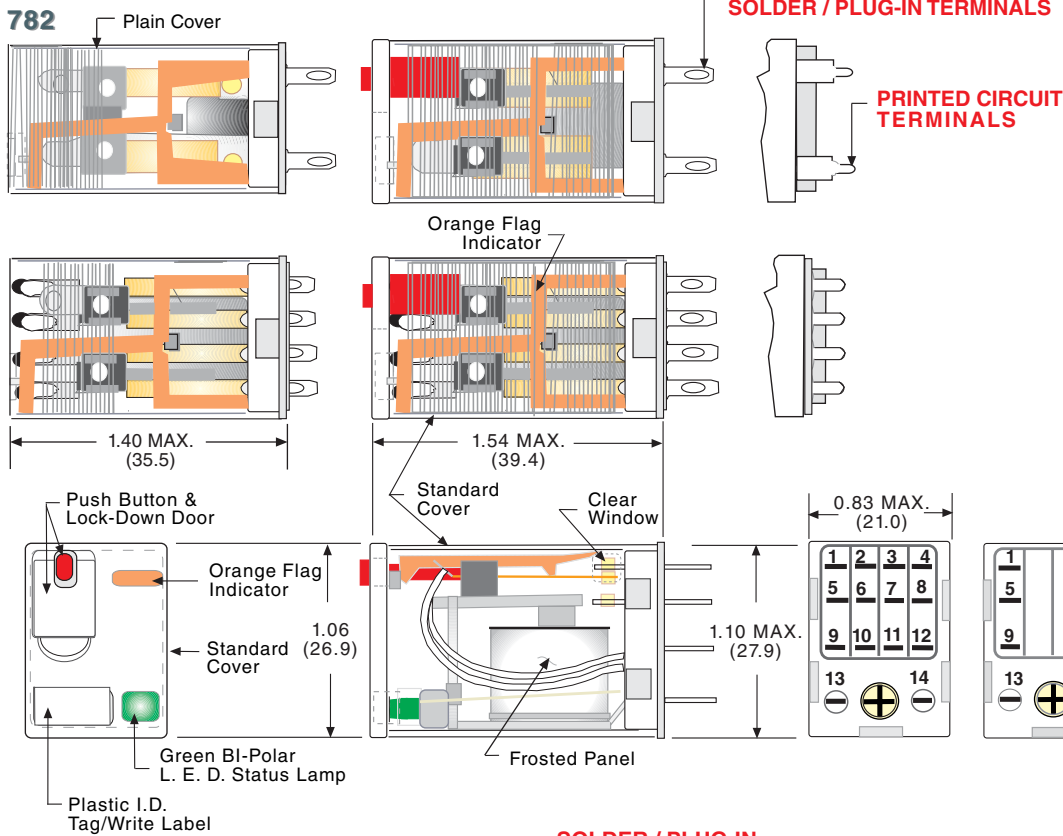

PRINTED CIRCUIT MOUNTING HOLE LAYOUT (TOP VIEW)

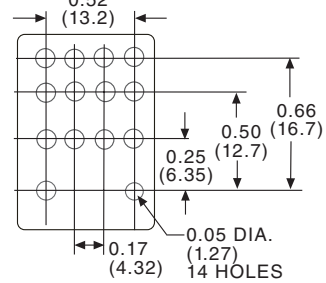

SOLDER / PLUG-IN TERMINALS

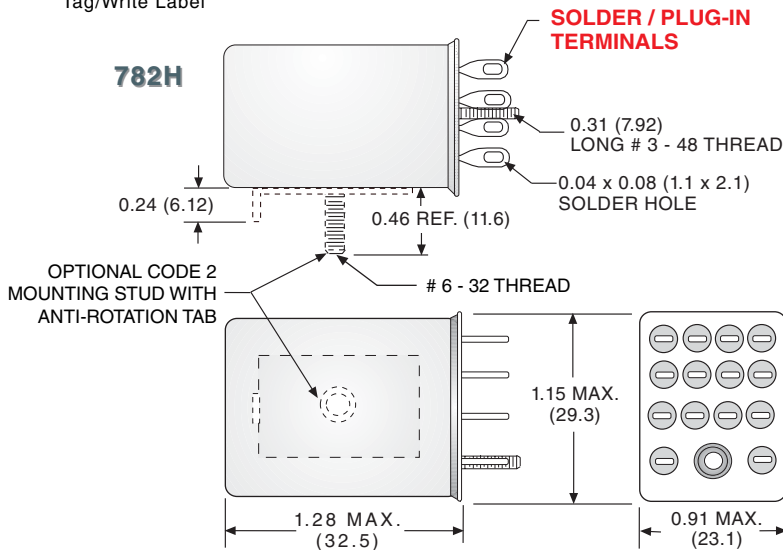

CERTIFIED CLASS 1
DIVISION 2 FOR
HAZARDOUS
LOCATIONS



782 - 2 & 4 POLE "ICE CUBE" CONTROL RELAYS



DPDT & 4PDT, 1, 3, 5 & 10 AMPS



ORDERING CODE

782

XDX

2 **M4L** **-120A**

CLASS:

CONTACT CONFIGURATION:
DPDT: **XBX**, 4PDT: **XDX**

CONTACT RATING (EXCEPT 782H):
3 AMP: **CODE 1**
10 AMP: **CODE 2**
3 AMP BIFURCATED CONTACT: **CODE 3**

HERMETICALLY SEALED (782H):
CODE H

OPTIONAL PLAIN COVER (EXCEPT 782H):
CODE C

TERMINALS STYLE (EXCEPT 782H):
QUICK CONNECT SOLDER/PLUG-IN TERMINALS: **NO CODE**
PRINTED CIRCUIT TERMINALS: **CODE T**

CONTACT RATING (782H ONLY):
1 AMP BIFURCATED CONTACT: **CODE 32**
(SILVER CROSS BAR WITH GOLD OVERLAY)
3 AMP: **CODE 10** (SILVER GOLD FLASHED)
5 AMP: **CODE 21** (SILVER ALLOY)

TERMINALS & MOUNTING STYLE (782H ONLY):
SOLDER/PLUG-IN: **NO CODE**
STUD ON BROAD SIDE: **CODE 2**
STUD ON NARROW SIDE: **CODE 3**
STUD ON TOP SIDE: **CODE 4**

FULL FEATURED VERSION:
PUSH BUTTON & LOCK-DOWN DOOR: **CODE M4**
BI - POLAR L.E.D. STATUS LAMP: **CODE L**

OPTIONAL FULL FEATURED DELETION:
PUSH BUTTON WITHOUT LOCK-DOWN DOOR: **CODE M**

OPTIONAL PLAIN COVER FEATURES:
PUSH BUTTON WITHOUT LOCK-DOWN DOOR: **CODE M**
POLARIZED L.E.D. STATUS LAMP: **CODE L** (OBSERVE POLARITY+)

COIL VOLTAGE:
6, 12, 24, 120, 220/230, 240 **ADD "A" FOR AC COILS**
6, 12, 24, 48, 110 **ADD "D" FOR DC COILS**

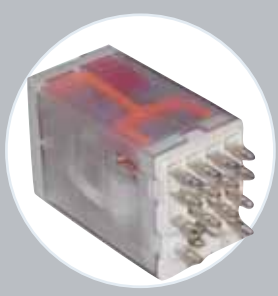

782 - 2 & 4 POLE "ICE CUBE" CONTROL RELAY



DPDT & 4PDT, 1, 3, 5 & 10 AMPS

OPTIONAL ADAPTERS
ORDERED SEPARATELY

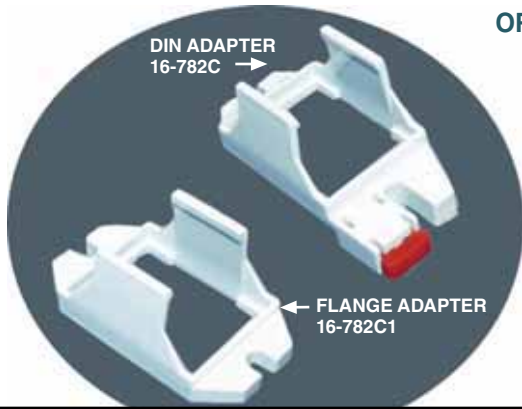

Mating Sockets
70-461-1, SCREW/DIN
70-378-1: SOLDER
70-379-1: PRINTED CIRCUIT
See section 7

STANDARD PART NUMBERS				COIL MEASURED @ 25 °C	
FULL FEATURED	PLAIN COVER WITH FLAG	HERMETICALLY SEALED	FULL FEATURED	NOMINAL INPUT VOLTAGE	NOMINAL RESISTANCE (OHMS)
4PDT				DPDT	
SOLDER/PLUG -IN, BIFURCATED CONTACTS 3 AMP					
	DUAL MARKED				
	NEW PART NUMBER	SUPERCEDES			
782XDX3M4L-24A	782XDX3C-12A	W78ATCSX-2		12 VAC, 50/60 Hz	46 Ω
	782XDX3C-24A	W78ATCSX-3	782XBX3M4L-24A	24 VAC, 50/60 Hz	180 Ω
782XDX3M4L-120A	782XDX3C-120A	W78ATCSX-5	782XBX3M4L-120A	110/120 VAC, 50/60 Hz	4,430 Ω
782XDX3M4L-220/230A	782XDX3C-220/230A		782XBX3M4L-220/230A	220/230 VAC, 50/60 Hz	15,000 Ω
782XDX3M4L-240A	782XDX3C-240A	W78ATCSX-6	782XBX3M4L-240A	240 VAC, 50/60 Hz	15,700 Ω
	782XDX3C-6D	W78TCSX-1		6 VDC	
782XDX3M4L-12D	782XDX3C-12D	W78TCSX-2	782XBX3M4L-12D	12 VDC	160 Ω
782XDX3M4L-24D	782XDX3C-24D	W78TCSX-3	782XBX3M4L-24D	24 VDC	650 Ω
782XDX3M4L-110D	782XDX3C-110D	W78TCSX-5	782XBX3M4L-110D	110/125 VDC	11,000 Ω
SOLDER/PLUG -IN, CONTACTS 3 AMP					
	782XDX1C-12A	W78ACXSX-2		12 VAC, 50/60 Hz	46 Ω
782XDX1M4L-24A	782XDX1C-24A	W78ACXSX-3	782XDXH10-24A	24 VAC, 50/60 Hz	180 Ω
782XDX1M4L-120A	782XDX1C-120A	W78ACXSX-5	782XDXH10-120A	110/120 VAC, 50/60 Hz	4,430 Ω
782XDX1M4L-220/230A	782XDX1C-220/230A			220/230 VAC, 50/60 Hz	15,000 Ω
782XDX1M4L-240A	782XDX1C-240A	W78ACXSX-6		240 VAC, 50/60 Hz	15,700 Ω
	782XDX1C-6D	W78CSX-1		6 VDC	
782XDX1M4L-12D	782XDX1C-12D	W78CSX-2	782XDXH10-12D	12 VDC	160 Ω
782XDX1M4L-24D	782XDX1C-24D	W78CSX-3	782XDXH10-24D	24 VDC	650 Ω
782XDX1M4L-110D	782XDX1C-110D	W78CSX-6	782XDXH10-110D	110/125 VDC	11,000 Ω
SOLDER/PLUG -IN, CONTACTS 10 AMP					
782XDX2M4L-24A	782XDX2C-24A	W78KACSX-15		24 VAC, 50/60 Hz	180 Ω
782XDX2M4L-120A	782XDX2C-120A	W78KACSX-17	782XDXH21-120A	110/120 VAC, 50/60 Hz	4,430 Ω
782XDX2M4L-220/230A	782XDX2C-220/230A			220/230 VAC, 50/60 Hz	15,000 Ω
782XDX2M4L-240A	782XDX2C-240A	W78KACSX-18		240 VAC, 50/60 Hz	15,700 Ω
782XDX2M4L-12D	782XDX2C-12D	W78KCSX-12	782XDXH21-12D	12 VDC	160 Ω
782XDX2M4L-24D	782XDX2C-24D	W78KCSX-13	782XDXH21-24D	24 VDC	650 Ω
782XDX2M4L-110D	782XDX2C-110D			110/125 VDC	11,000 Ω
PRINTED CIRCUIT BIFURCATED CONTACTS 3 AMP					
	782XDX3CT-24A	W78APCX-3		24 VAC, 50/60 Hz	180 Ω
	782XDX3CT-120A	W78APCX-5		110/120 VAC, 50/60 Hz	4430 Ω
	782XDX3CT-12D	W78PCX-2		12 VDC	15700 Ω
	782XDX3CT-24D	W78PCX-3		24 VDC	160 Ω
	782XDX3CT-110D	W78PCX-6		110/125 VDC	11,000 Ω

NOTE: CLASS 782C IS AN ENHANCED VERSION OF THE 78, IT HAS SUPERIOR RATINGS, A FLAG INDICATOR, & DISPLAYS BOTH PART NUMBERS.

UL us
UL Recognized
File No. E43641



COMPLIES WITH REQUIREMENTS OF

* IEC STANDARDS 947-4-1 AND 947-5-1 LOW VOLTAGE DIRECTIVE

* IEC = INTERNATIONAL ELECTROTECHNICAL COMMISSION

* CE TESTING AND EVALUATION PERFORMED BY THE UNDERWRITERS LABORATORIES AS A THIRD PARTY PARTICIPANT



LISTED 367G
IND. CONT. EQ.

WHEN USED WITH
SOCKETS:

70-464-1, 70-465-1,
70-750D8-1 & 70-750D11-1

CURRENT LIMITED
TO RATING OF
RELAY OR SOCKET
WHICHEVER IS LESS

FEATURES

FLAG INDICATOR:

BI - POLAR L.E.D. STATUS LAMP:

COLOR CODED PUSH BUTTON:

LOCK-DOWN DOOR:

FINGER - GRIP COVER:

WHITE PLASTIC I.D. TAG/WRITE LABEL:

BENEFITS

SHOWS RELAY STATUS IN MANUAL OR POWERED CONDITION.

ALLOWS FOR REVERSE POLARITY APPLICATIONS, SHOWS COIL "ON" OR "OFF" STATUS. IDEAL IN LOW LIGHT CONDITIONS.

IDENTIFIES AC COILS WITH RED OR DC COILS WITH BLUE PUSH BUTTONS. ALLOWS FOR MANUAL OPERATION OF RELAY WITHOUT THE NEED FOR COIL POWER. IDEAL FOR FIELD SERVICE PERSONNEL TO TEST CONTROL CIRCUITS.

WHEN ACTIVATED, HOLDS PUSH BUTTON AND CONTACTS IN THE OPERATE POSITION. EXCELLENT FOR ANALYZING CIRCUIT PROBLEMS.

ALLOWS OPERATOR TO REMOVE RELAYS FROM SOCKETS MORE EASILY THAN CONVENTIONAL RELAYS.

USED FOR IDENTIFICATION OF RELAYS IN MULTI-RELAY CIRCUITS.



MANUFACTURED UNDER ISO 9002 & QS 9000



GENERAL SPECIFICATIONS (@ 25°C)

	UNITS	
COIL		
Pull-in Voltage AC (50/60 Hz):≤	% of nominal	85
Pull-in Voltage DC:≤	% of nominal	80
Dropout Voltage AC (50/60 Hz):≥	% of nominal	10
Dropout Voltage DC:≥	% of nominal	10
Maximum Voltage:	% of nominal	110
Resistance:	% ±	10
Coil Power AC (60 Hz):	VA	2.0 - 3.0
Coil Power DC:	W	1.4
Insulation System Per UL Standard 1446:		Class B (130 °C)
Maximum Coil Dissipation, AC (60 Hz):	VA	3.5
Maximum Coil Dissipation, DC:	W	3
Duty:		Continuous
CONTACTS		
Contact Material:		Silver alloy, gold flashed
Contact Rating AC Amperes (AC1):	A	16
Contact Rating AC Voltage:	V	277
Contact Rating DC Amperes (DC1):	A	16 / 0.5
Contact Rating DC Voltage:	V	28 / 220
General Purpose Rating (75%-80% pf):	A @ V	12 @ 120 / 240
Horse Power (AC):	HP	1/3 @ 120 V
Horse Power (AC):	HP	1/2 @ 240 V
Pilot Duty (60 Hz):		B300
Utilization Category:	IEC	AC15
VA Rating Make:	VA	3600
VA Rating Break:	VA	360
Minimum Recommended Load:	ma	100 @ 5 VDC or 0.5 W
TIMING		
Operate Time:	ms	20
Release Time:	ms	20

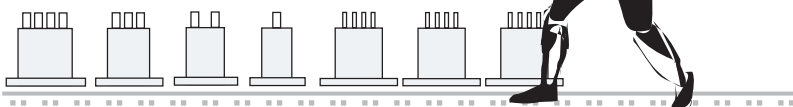

	UNITS	
DIELECTRIC STRENGTH		
Coil to Contacts:	V rms	2500
Across Open Contacts:	V rms	1500
Pole to Pole:	V rms	2500
Contacts to Frame:	V rms	2500
Insulation Resistance:	megohms minimum @VDC	100 @ 500
VIBRATION RESISTANCE		
Functional:	g's	10-55 Hz, 6 g's, 1mm double amplitude
SHOCK RESISTANCE		
Functional:	g's	10
TEMPERATURE		
Operating, AC Lower:	°C	-40
Operating, AC Upper:	°C	+50
Operating, DC Lower:	°C	-40
Operating, DC Upper:	°C	+65
Storage, Lower:	°C	-40
Storage, Upper:	°C	+105
LIFE EXPECTANCY		
Electrical @ Rated Load (AC1):	operations	100,000
Mechanical @ no Load :	operations	5,000,000
MISCELLANEOUS		
Operating Position:		Any
Insulation Material:	94V-0	Molded plastic
Enclosure Material:	94V-0	Polycarbonate
Cover Protection Category:	IP	40
Weight:	grams	89

750 OCTAL STYLE POWER RELAY



DPDT & 3PDT 16 AMPS

OUTLINE DIMENSIONS

DIMENSIONS SHOWN IN INCHES & (MILLIMETERS).

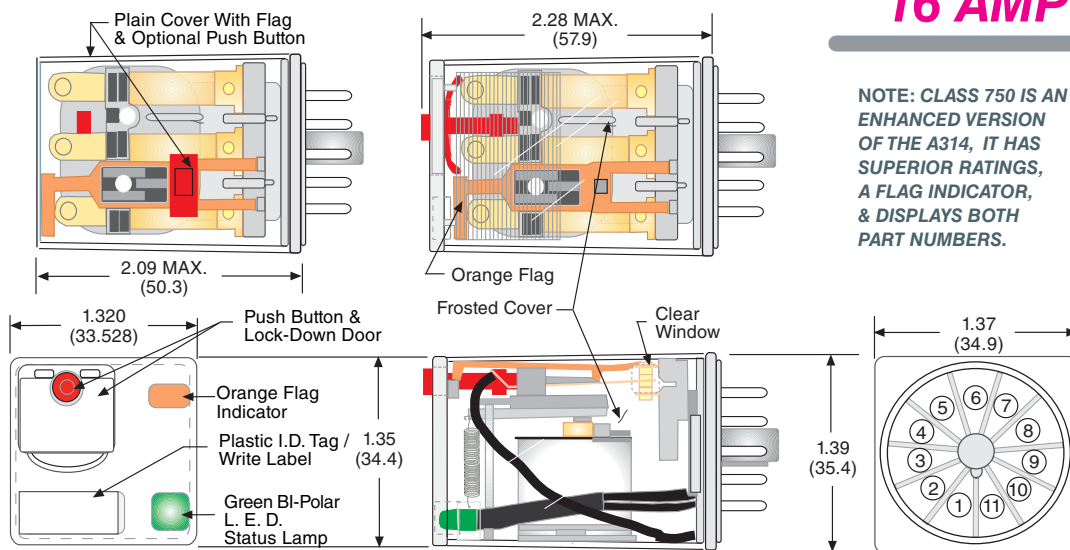

NOTE: CLASS 750 IS AN ENHANCED VERSION OF THE A314, IT HAS SUPERIOR RATINGS, A FLAG INDICATOR, & DISPLAYS BOTH PART NUMBERS.

WIRING DIAGRAM (VIEWED FROM PIN END)

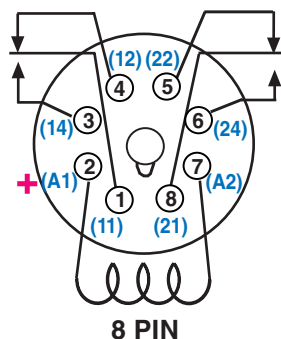

8 PIN

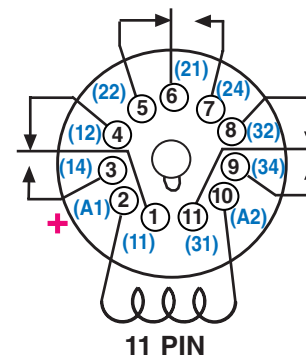

11 PIN

ALTERNATE NEMA OR IEC () NUMBERS VIEWED FROM PIN SIDE

ORDERING CODE

750 **XBX** **M4L** **-120A**

- CLASS:** 750
- CONTACT CONFIGURATION:** DPDT: XBX, 3PDT: XCX
- OPTIONAL PLAIN COVER:** CODE C
- OPTIONS:** MAGNETIC BLOWOUT: CODE 69
- FULL FEATURED VERSION:** PUSH BUTTON & LOCK DOWN DOOR: CODE M4
BI - POLAR L.E.D. STATUS LAMP: CODE L
- OPTIONAL FULL FEATURED DELETION:** PUSH BUTTON WITHOUT LOCK-DOWN DOOR: CODE M.
(CODES 69, L, OR M ALSO AVAILABLE ON CLEAR COVER VERSIONS)
- OPTIONAL PLAIN COVER FEATURES:** PUSH BUTTON WITHOUT LOCK-DOWN DOOR: CODE M
POLARIZED L.E.D. STATUS LAMP: CODE L (OBSERVE POLARITY+)
- COIL VOLTAGE:** 6, 12, 24, 120, 220 / 240 ADD "A" FOR AC COILS
6, 12, 24, 48, 110 ADD "D" FOR DC COILS



Mating Sockets

70-750D8-1, 70-750D11-1,
70-464-1, 70-465-1, 70-750E8-1, 70-750E11-1
70-750EL/SL8-1, 70-750EL/SL11-1: SCREW/DIN
70-169-1, 70-170-1: SCREW/PANEL

See section 7

STANDARD PART NUMBERS			COIL MEASURED @ 25 °C	
FULL FEATURED	PLAIN COVER WITH FLAG	CONTACT CONFIGURATION	NOMINAL INPUT VOLTAGE	NOMINAL RESISTANCE(OHMS)
AC OPERATED - 8 PIN OCTAL, 16 AMP				
DUAL MARKED				
	NEW PART NUMBER	SUPERCEDES		
750XBXM4L-24A	750XBXC-24A	A314XBX48P-24A	24 VAC, 50/60Hz	72 Ω
750XBXM4L-120A	750XBXC-120A	A314XBX48P-120A	110/120 VAC, 50/60Hz	1,700 Ω
750XBXM4L-220/240A	750XBXC-220/240A	A314XBX48P-220/240A	220/240 VAC, 50/60Hz	7,200 Ω
DC OPERATED - 8 PIN OCTAL, 16 AMP				
750XBXM4L-12D	750XBXC-12D	A314XBX48P-12D	12 VDC	120 Ω
750XBXM4L-24D	750XBXC-24D	A314XBX48P-24D	24 VDC	470 Ω
750XBXM4L-110D	750XBXC-110D	A314XBX48P-110D	110/125 VDC	10,000 Ω
AC OPERATED - 11 PIN OCTAL, 16 AMP				
750XCXM4L-24A	750XCXC-24A	A314XCX48P-24A	24 VAC, 50/60Hz	72 Ω
750XCXM4L-120A	750XCXC-120A	A314XCX48P-120A	110/120 VAC, 50/60Hz	1,700 Ω
750XCXM4L-220/240A	750XCXC-220/240A	A314XCX48P-220/240A	220/240 VAC, 50/60Hz	7,200 Ω
DC OPERATED - 11 PIN OCTAL, 16 AMP				
750XCXM4L-12D	750XCXC-12D	A314XCX48P-12D	12 VDC	120 Ω
750XCXM4L-24D	750XCXC-24D	A314XCX48P-24D	24 VDC	470 Ω
750XCXM4L-110D	750XCXC-110D	A314XCX48P-110D	110/125 VDC	10,000 Ω

UL US
UL Recognized
File No. E43641

SE 40787
TÜV

CE

COMPLIES WITH REQUIREMENTS OF

* IEC STANDARDS 947-4-1 AND 947-5-1 LOW VOLTAGE DIRECTIVE

* IEC = INTERNATIONAL ELECTROTECHNICAL COMMISSION

* CE TESTING AND EVALUATION PERFORMED BY THE UNDERWRITERS LABORATORIES AS A THIRD PARTY PARTICIPANT

UL US

LISTED 367G
IND. CONT. EQ.

WHEN USED WITH
SOCKET 70-463-1

CURRENT LIMITED TO
RATING OF RELAY OR
SOCKET WHICHEVER
IS LESS

FEATURES

FLAG INDICATOR:

BI - POLAR L.E.D. STATUS LAMP:

COLOR CODED PUSH BUTTON:

LOCK-DOWN DOOR:

FINGER - GRIP COVER:

WHITE PLASTIC I.D. TAG/WRITE LABEL:

BENEFITS

SHOWS RELAY STATUS IN MANUAL OR POWERED CONDITION.

ALLOWS FOR REVERSE POLARITY APPLICATIONS, SHOWS COIL "ON" OR "OFF" STATUS. IDEAL IN LOW LIGHT CONDITIONS.

IDENTIFIES AC COILS WITH RED OR DC COILS WITH BLUE PUSH BUTTONS. ALLOWS FOR MANUAL OPERATION OF RELAY WITHOUT THE NEED FOR COIL POWER. IDEAL FOR FIELD SERVICE PERSONNEL TO TEST CONTROL CIRCUITS.

WHEN ACTIVATED, HOLDS PUSH BUTTON AND CONTACTS IN THE OPERATE POSITION. EXCELLENT FOR ANALYZING CIRCUIT PROBLEMS.

ALLOWS OPERATOR TO REMOVE RELAYS FROM SOCKETS MORE EASILY THAN CONVENTIONAL RELAYS.

USED FOR IDENTIFICATION OF RELAYS IN MULTI-RELAY CIRCUITS.



MANUFACTURED
UNDER
ISO 9002
& QS 9000



GENERAL SPECIFICATIONS (@ 25°C)

	UNITS	
COIL		
Pull-in Voltage AC (50/60 Hz):≤	% of nominal	85
Pull-in Voltage DC:≤	% of nominal	80
Dropout Voltage AC (50/60 Hz):≥	% of nominal	10
Dropout Voltage DC:≥	% of nominal	10
Maximum Voltage:	% of nominal	110
Resistance:	% ±	10
Coil Power AC (60 Hz):	VA	2.0 - 3.0
Coil Power DC:	W	1.4
Insulation System Per UL Standard 1446:		Class B (130 °C)
Maximum Coil Dissipation, AC (60 Hz):	VA	3.5
Maximum Coil Dissipation, DC:	W	3
Duty:		Continuous
CONTACTS		
Contact Material:		Silver alloy, gold flashed
Contact Rating AC Amperes (AC1):	A	16
Contact Rating AC Voltage:	V	277
Contact Rating DC Amperes (DC1):	A	16 / 0.5
Contact Rating DC Voltage:	V	28 / 220
Horse Power (AC):	HP	1/3 @ 120 V
Horse Power (DC):	HP	1/2 @ 240 V
Pilot Duty (60 Hz):		B300
Utilization Category:	IEC	AC15
VA Rating Make:	VA	3600
VA Rating Break:	VA	360
Minimum Recommended Load:	ma	100 @ 5 VDC or 0.5 W
TIMING		
Operate Time:	ms	20
Release Time:	ms	20

	UNITS	
DIELECTRIC STRENGTH		
Coil to Contacts:	V rms	2500
Across Open Contacts:	V rms	1500
Pole to Pole:	V rms	2500
Contacts to Frame:	V rms	
Insulation Resistance:	megohms minimum @VDC	1000 @ 500
VIBRATION RESISTANCE		
Functional:	g's	10-55 Hz, 6 g's, 1mm double amplitude
SHOCK RESISTANCE		
Functional:	g's	10
TEMPERATURE		
Operating, AC Lower:	°C	-40
Operating, AC Upper:	°C	+50
Operating, DC Lower:	°C	-40
Operating, DC Upper:	°C	+65
Storage, Lower:	°C	-40
Storage, Upper:	°C	+105
LIFE EXPECTANCY		
Electrical @ Rated Load (AC1):	operations	100,000
Mechanical @ no Load :	operations	5,000,000
MISCELLANEOUS		
Operating Position:		Any
Insulation Material:	94V-0	Molded plastic
Enclosure Material:	94V-0	Polycarbonate
Cover Protection Category:	IP	40
Terminals:	Inch (mm)	0.187, 0.062 x 0.020 (4.74, 1.57 x 0.508)
Weight:	grams	88

788 PLUG-IN POWER RELAY



DPDT & 3PDT, 16 AMPS

WIRING DIAGRAM
(VIEWED FROM PIN END)

OUTLINE DIMENSIONS

DIMENSIONS SHOWN IN INCHES & (MILLIMETERS).

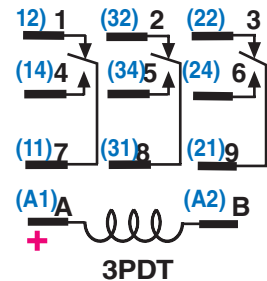
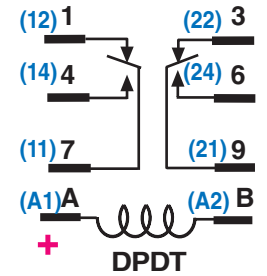
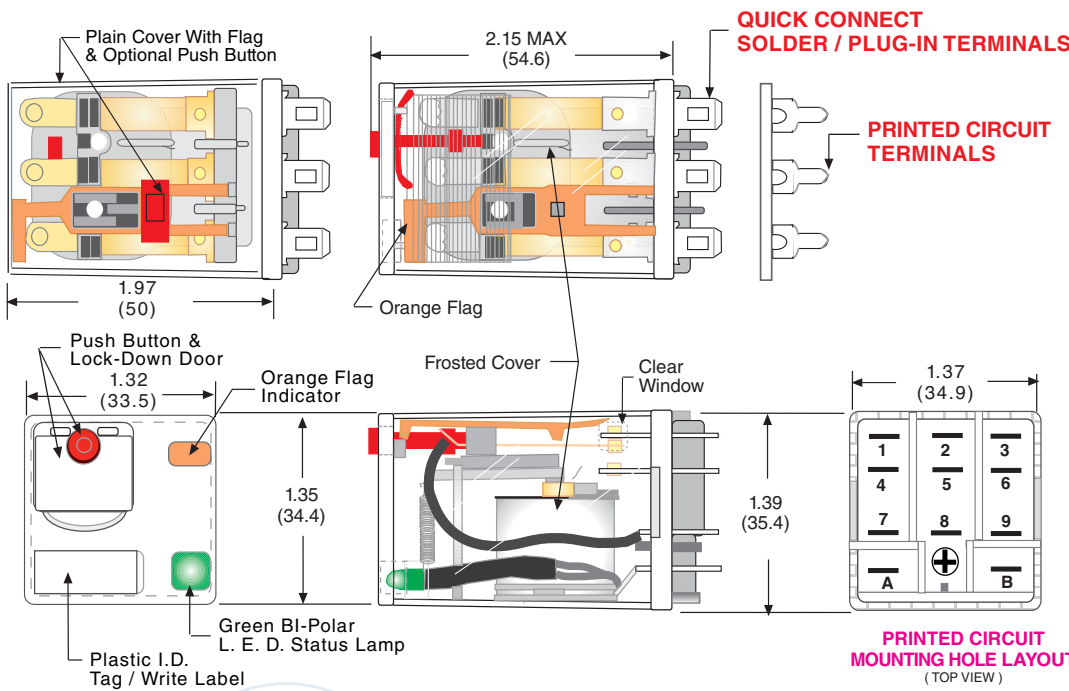

ALTERNATE NEMA OR IEC () NUMBERS VIEWED FROM PIN SIDE

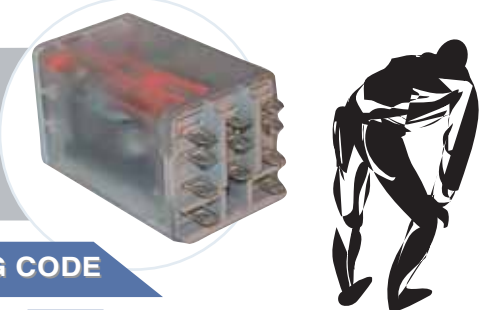

ORDERING CODE

788 **XBX** **M4L** **-120A**

CLASS:

CONTACT CONFIGURATION:
DPDT: **XBX**, 3PDT: **XCX**

OPTIONAL PLAIN COVER:
CODE **C**

TERMINAL STYLE:
SOLDER PLUG-IN TERMINALS: **NO CODE**
PRINTED CIRCUIT TERMINALS: **CODE T**

FULL FEATURED VERSION:
PUSH BUTTON & LOCK DOWN DOOR: **CODE M4**
BI - POLAR L.E.D. STATUS LAMP: **CODE L**

OPTIONAL FULL FEATURED DELETION:
PUSH BUTTON WITHOUT LOCK DOWN DOOR: **CODE M**

OPTIONAL PLAIN COVER FEATURES:
PUSH BUTTON WITHOUT LOCK-DOWN DOOR: **CODE M**
POLARIZED L.E.D. STATUS LAMP: **CODE L**
(OBSERVE POLARITY **+**)

COIL VOLTAGE:
6, 12, 24, 120, 220 / 240 **ADD "A" FOR AC COILS**
6, 12, 24, 48, 110 **ADD "D" FOR DC COILS**

Mating Sockets
70-463-1: SCREW/DIN
70-124-1: SOLDER
70-178-1, 70-178-2: PRINTED CIRCUIT
70-788EL/SL11-1, 70-124-2: QUICK CONNECT
See section 7

FULL FEATURED	CONTACT CONFIGURATION	COIL MEASURED @ 25 °C	
		NOMINAL INPUT VOLTAGE	NOMINAL RESISTANCE (OHMS)
AC OPERATED - SOLDER/PLUG-IN, 16 AMP			
788XBXM4L-24A	DPDT	24 VAC, 50/60Hz	72 Ω
788XBXM4L-120A	DPDT	110/120 VAC, 50/60Hz	1,700 Ω
788XBXM4L-220/240A	DPDT	220/240 VAC, 50/60Hz	7,200 Ω
DC OPERATED - SOLDER/PLUG-IN, 16 AMP			
788XBXM4L-12D	DPDT	12 VDC	120 Ω
788XBXM4L-24D	DPDT	24 VDC	470 Ω
788XBXM4L-110D	DPDT	110/125 VDC	10,000 Ω
AC OPERATED - SOLDER/PLUG-IN, 16 AMP			
788XCXM4L-24A	3PDT	24 VAC, 50/60Hz	72 Ω
788XCXM4L-120A	3PDT	110/120 VAC, 50/60Hz	1,700 Ω
788XCXM4L-220/240A	3PDT	220/240 VAC, 50/60Hz	7,200 Ω
DC OPERATED - SOLDER/PLUG-IN, 16 AMP			
788XCXM4L-12D	3PDT	12 VDC	120 Ω
788XCXM4L-24D	3PDT	24 VDC	470 Ω
788XCXM4L-110D	3PDT	110/125 VDC	10,000 Ω

CADMIUM-FREE CONTACTS AVAILABLE,
CONTACT FACTORY FOR DETAILS

UL CONTACT LOAD RATINGS TABLE

CONTACT CONFIGURATION	CURRENT OR HORSE POWER	LOAD VOLTAGE	LOAD VOLTAGE FREQUENCY	TYPE OF LOAD
1 POLE THRU 3 POLES	15 AMP	240 VAC	50/60 Hz	RESISTIVE
	10 AMP	28 VDC	DC	RESISTIVE
	1/3 HP	120 VAC	50/60 Hz	MOTOR
	1/2 HP	240 VAC	50/60 Hz	MOTOR
	3 AMP	600 VAC	50/60 Hz	RESISTIVE

UL US
UL Recognized
File No. E13224

CS
168986

CE

COMPLIES WITH REQUIREMENTS OF

- * IEC STANDARDS 947-4-1 AND 947-5-1 LOW VOLTAGE DIRECTIVE
- * IEC = INTERNATIONAL ELECTROTECHNICAL COMMISSION
- * CE TESTING AND EVALUATION PERFORMED BY THE UNDERWRITERS LABORATORIES AS A THIRD PARTY PARTICIPANT

UL CONTACT LOAD RATINGS TABLE FOR DC SWITCHING

(WITH OPTIONAL MAGNETIC BLOWOUT: CODE 69)

CONTACT CONFIGURATION	CURRENT OR HORSE POWER	LOAD VOLTAGE	TYPE OF LOAD
DPDT	3 AMP	150 VDC	RESISTIVE
DPST - NO	5 AMP	150 VDC	RESISTIVE
SPST - NO (DM)	10 AMP	150 VDC	RESISTIVE
SPDT (DB and DM)	10 AMP	150 VDC	RESISTIVE

MANUFACTURED UNDER ISO 9002 & QS 9000

UL US

LISTED 367G IND. CONT. EQ.

WHEN USED WITH SOCKETS 70-463-1

CURRENT LIMITED TO RATING OF RELAY OR SOCKET WHICHEVER IS LESS

GENERAL SPECIFICATIONS (@ 25°C)

	UNITS	
COIL		
Pull-in Voltage AC (50/60 Hz):≤	% of nominal	85
Pull-in Voltage DC:≤	% of nominal	80
Dropout Voltage AC (50/60 Hz):≥	% of nominal	10
Dropout Voltage DC:≥	% of nominal	10
Maximum Voltage:	% of nominal	110
Resistance:	% ±	10
Coil Power AC (60 Hz):	VA	2.75
Coil Power DC:	W	2
Insulation System Per UL Standard 1446:		Class B (130 °C)
Duty:		Continuous
CONTACTS		
Contact Material:		Silver alloy gold flashed
Contact Rating AC Amperes (AC1):	A	15
Contact Rating AC Voltage:	V	240
Contact Rating DC Amperes (DC1):	A	10
Contact Rating DC Voltage:	V	28
Horse Power (AC):	HP	1/3 @ 120 V
Horse Power (DC):	V	1/2 @ 240 V
Minimum Recommended Load:	ma	100 @ 5 VDC or 0.5 W
DIELECTRIC STRENGTH		
Coil to Contacts:	V rms	2000
Across Open Contacts:	V rms	500
Pole to Pole:	V rms	2000
Contacts to Frame:	V rms	Not applicable
Insulation Resistance:	megohms minimum @ VDC	1000 @ 500

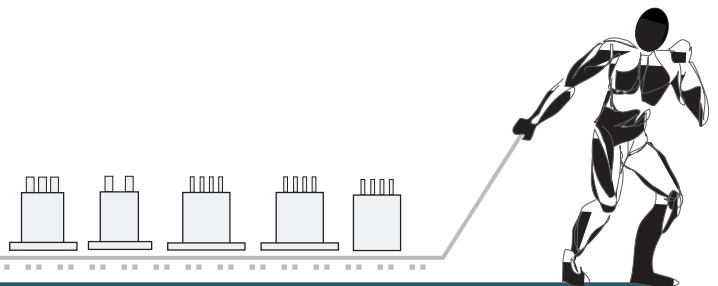

	UNITS	
TEMPERATURE		
Operating, AC Lower:	°C	-30
Operating, AC Upper:	°C	+60
Operating, DC Lower:	°C	-30
Operating, DC Upper:	°C	+50
Storage, Lower:	°C	-30
Storage, Upper:	°C	+100
LIFE EXPECTANCY		
Electrical @ Rated Load (AC1):	operations	100,000
Mechanical @ no Load :	operations	10,000,000
MISCELLANEOUS		
Operating Position:		Any
Insulation Material:	94V-0	Molded plastic
Enclosure Material:	94V-0	Polycarbonate
Cover Protection Category:	IP	40
Terminals:	Inch (mm)	0.187, 0.062 x 0.020 (4.74, 1.57 x 0.508)
Weight:	grams	88

A283 PLUG-IN & FLANGE MOUNT RELAYS



PLUG-IN

FLANGE MOUNT

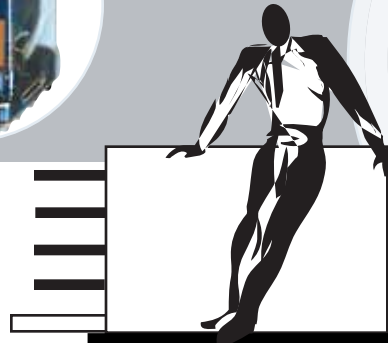
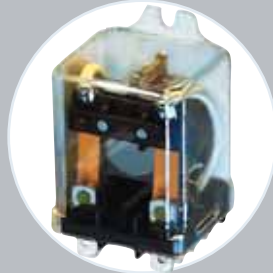
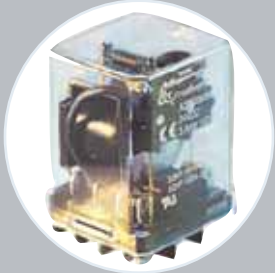

RECOMMENDED PRINTED CIRCUIT LAYOUT (TOP VIEW)

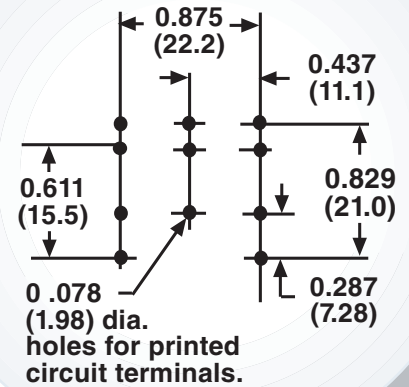

ORDERING CODE

A283 **XCX** **C1** **M-** **240A**

CLASS:

CONTACT CONFIGURATION:

SPDT: **XAX**
DPDT: **XBX**
DPST-NO: **BXX**
3PDT: **XCX**
SPST -NO-DM: **HXX**
SPDT -DB and DM: **XXH**

OPTIONAL:

MAGNETIC BLOWOUT: **CODE 69**

CONSTRUCTION STYLE:

* ENCLOSED, PLAIN COVER: **CODE C**
ENCLOSED, FLANGE COVER: **CODE C1**
ENCLOSED TOP FLANGE MOUNT: **CODE C3**
ENCLOSED DIN MOUNT: **CODE C4**

TERMINAL STYLE:

QUICK CONNECT SOLDER TERMINALS: **NO CODE**
PRINTED CIRCUIT TERMINALS: **CODE T**

OPTIONS:

BI - POLAR L.E.D. STATUS LAMP: **CODE L**
PUSH BUTTON: **CODE M**

COIL VOLTAGE:

6, 12, 24, 120, 240 **ADD "A" FOR AC COILS**
6, 12, 24, 48, 110 **ADD "D" FOR DC COILS**

* Note: Code C recommended to be used with printed circuit terminals or Plug-in applications only.

OPTIONAL PRINTED CIRCUIT TERMINAL



OPTIONAL TOP FLANGE COVER



OPTIONAL DIN COVER

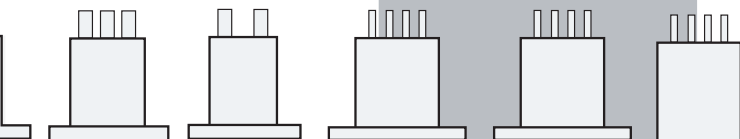

A283 PLUG-IN & FLANGE MOUNT RELAYS



SPDT, DPDT & 3PDT, 15 AMPS

WIRING DIAGRAM (VIEWED FROM PIN END)

OUTLINE DIMENSIONS

DIMENSIONS SHOWN IN INCHES & (MILLIMETERS).

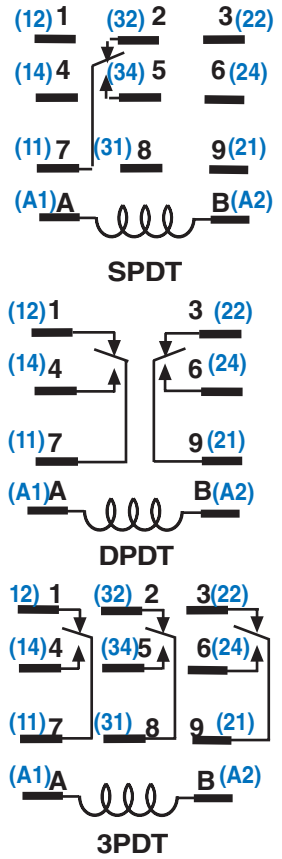
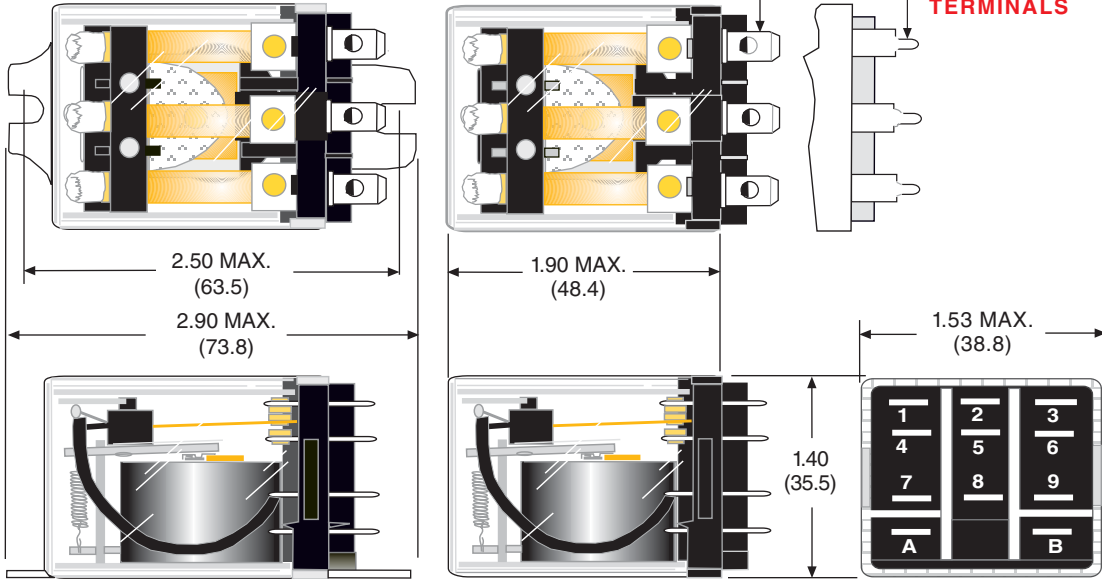

ALTERNATE NEMA
OR IEC () NUMBERS
VIEWED FROM
PIN SIDE

Mating Sockets

70-463-1: SCREW/DIN

70-124-1: SOLDER

70-178-1, 70-178-2: PRINTED CIRCUIT

70-788EL/SL-1, 170-124-2: QUICK CONNECT

See section 7

SEE CLASS 788 FOR
PART NUMBERS WITH
L.E.D. STATUS LAMP
AND PUSH BUTTON

FLANGE MOUNT

STANDARD PART NUMBERS	CONTACT CONFIGURATION	COIL MEASURED @ 25 °C	
		NOMINAL INPUT VOLTAGE	NOMINAL RESISTANCE (OHMS)
AC OPERATED, 15 AMP			
A283XAXC1-120A	SPDT	110/120 VAC, 50/60Hz	2250 Ω
A283XAXC1-240A	SPDT	220/240 VAC, 50/60Hz	9100 Ω
A283XBXC1-120A	DPDT	110/120 VAC, 50/60Hz	2250 Ω
A283XBXC1-240A	DPDT	220/240 VAC, 50/60Hz	9100 Ω
A283XCXC1-120A	3PDT	110/120 VAC, 50/60Hz	1700 Ω
A283XCXC1-240A	3PDT	220/240 VAC, 50/60Hz	7200 Ω
DC OPERATED, 15 AMP			
A283XAXC1-12D	SPDT	12 VDC	120 Ω
A283XAXC1-24D	SPDT	24 VDC	472 Ω
A283XBXC1-12D	DPDT	12 VDC	120 Ω
A283XBXC1-24D	DPDT	24 VDC	472 Ω
A283XCXC1-12D	3PDT	12 VDC	120 Ω
A283XCXC1-24D	3PDT	24 VDC	472 Ω

PLUG-IN

STANDARD PART NUMBERS	CONTACT CONFIGURATION	COIL MEASURED @ 25 °C	
		NOMINAL INPUT VOLTAGE	NOMINAL RESISTANCE (OHMS)
AC OPERATED SOLDER/PLUG-IN, 15 AMP			
A283XAXC-120A	SPDT	110/120 VAC, 50/60Hz	2250 Ω
A283XAXC-240A	SPDT	220/240 VAC, 50/60Hz	9100 Ω
A283XBXC-24A	DPDT	24 VAC, 50/60Hz	75 Ω
A283XBXC-120A	DPDT	110/120 VAC, 50/60Hz	2250 Ω
A283XBXC-240A	DPDT	220/240 VAC, 50/60Hz	9100 Ω
A283XCXC-24A	3PDT	24 VAC, 50/60Hz	72 Ω
A283XCXC-120A	3PDT	110/120 VAC, 50/60Hz	1700 Ω
A283XCXC-240A	3PDT	220/240 VAC, 50/60Hz	7200 Ω
DC OPERATED SOLDER/PLUG-IN, 15 AMP			
A283XAXC-12D	SPDT	12 VDC	120 Ω
A283XAXC-24D	SPDT	24 VDC	472 Ω
A283XBXC-12D	DPDT	12 VDC	120 Ω
A283XBXC-24D	DPDT	24 VDC	472 Ω
A283XBXC-110D	DPDT	110/125 VDC	10,000 Ω
A283XCXC-12D	3PDT	12 VDC	120 Ω
A283XCXC-24D	3PDT	24 VDC	472 Ω

A283 PLUG-IN RELAY FOR DC SWITCHING



DPDT, SPST-NO-DM 3, 5 & 10 AMPS 150 VDC SWITCHING

OUTLINE DIMENSIONS DIMENSIONS SHOWN IN INCHES & (MILLIMETERS).

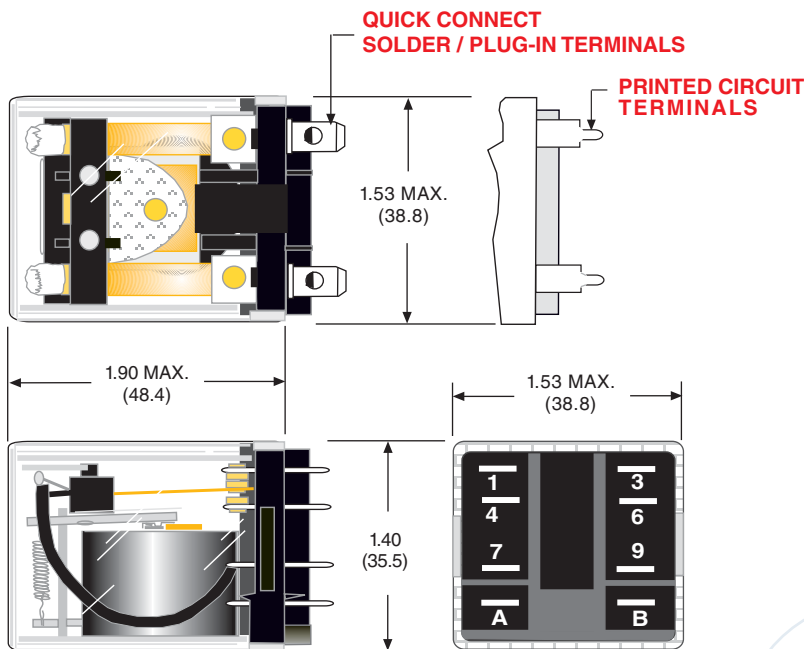

WIRING DIAGRAM (VIEWED FROM PIN END)

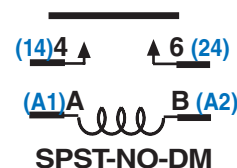
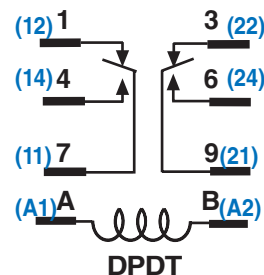

ALTERNATE NEMA
OR IEC () NUMBERS
VIEWED FROM
PIN SIDE

BLOWOUT MAGNET STANDARD FEATURE

THE BLOWOUT MAGNET STYLES HAVE
THE SAME LOAD SPECIFICATIONS AS
THE A283 ENCLOSED PLUG-IN RELAYS,
PLUS THE ADDITIONAL DC LOAD RATINGS.
SEE A283 GENERAL SPECIFICATIONS.



SEE CLASS 788 FOR
PART NUMBERS WITH
L.E.D. STATUS LAMP
AND PUSH BUTTON



Mating Sockets
70-463-1: SCREW/DIN
70-124-1: SOLDER
70-178-1, 70-178-2: PRINTED CIRCUIT
70-788EL/SL-1, 70-124-2: QUICK CONNECT
See section 7

STANDARD PART NUMBERS	CONTACT CONFIGU- RATION	COIL MEASURED @ 25 °C	
		NOMINAL INPUT VOLTAGE	NOMINAL RESISTANCE (OHMS)
AC OPERATED WITH BLOWOUT MAGNET, 3 AMP			
A283XBX69C-120A	DPDT	110/120 VAC, 50/60Hz	2250 Ω
DC OPERATED WITH BLOWOUT MAGNET, 3 AMP			
A283XBX69C-12D	DPDT	12 VDC	120 Ω
A283XBX69C-24D	DPDT	24 VDC	472 Ω
A283XBX69C-110D	DPDT	110/125 VDC	10,000 Ω
AC OPERATED WITH BLOWOUT MAGNET, 10 AMP			
A283HXX69C-120A	SPST-NO (DM)	110/120 VAC, 50/60Hz	2250 Ω
DC OPERATED WITH BLOWOUT MAGNET, 10 AMP			
A283HXH69C-48D	SPDT-NO (DB-DM)	48 VDC	1800 Ω
DC OPERATED WITH BLOWOUT MAGNET, 5 AMP			
A283BXX69C-24D	DPST-NO	24 VDC	472 Ω
A283BXX69C-48D	DPST-NO	48 VDC	1800 Ω
DC OPERATED WITH BLOWOUT MAGNET, 10 AMP			
A283HXX69C-12D	SPST-NO (DM)	12 VDC	120 Ω
A283HXX69C-24D	SPST-NO (DM)	24 VDC	472 Ω
A283HXX69C-48D	SPST-NO (DM)	48 VDC	1800 Ω
A283HXX69C-110D	SPST-NO (DM)	110/125 VDC	10,000 Ω

UL CONTACT LOAD RATINGS TABLE FOR 388J

CONTACT CONFIGURATION	CURRENT OR HORSE POWER	LOAD VOLTAGE	LOAD VOLTAGE FREQUENCY	TYPE OF LOAD
DPDT	20 AMP	300 VAC	50/60 Hz	RESISTIVE
	20 AMP	28 VDC	DC	RESISTIVE
3PDT	16 AMP	277 VAC	50/60 Hz	RESISTIVE
	16 AMP	28 VDC	DC	RESISTIVE
2 & 3 POLES	3/4 HP	120 VAC	50/60 Hz	MOTOR
	1 HP	208 - 600 VAC	50/60 Hz	MOTOR

MANUFACTURED UNDER ISO 9002 & QS 9000

UL CONTACT LOAD RATINGS TABLE FOR 388V

CONTACT CONFIGURATION	CURRENT OR HORSE POWER	LOAD VOLTAGE	LOAD VOLTAGE FREQUENCY	TYPE OF LOAD
1 POLE THRU 3 POLES	15 AMP	240 VAC	50/60 Hz	RESISTIVE
	15 AMP	28 VDC	DC	RESISTIVE
	1/3 HP	120 VAC	50/60 Hz	MOTOR
	1/2 HP	240 VAC	50/60 Hz	MOTOR

UL US
UL Recognized
File No. E43641

CS
168986 for 388J
41729 for 388V



COMPLIES WITH REQUIREMENTS OF

* IEC STANDARDS 947-4-1 AND 947-5-1 LOW VOLTAGE DIRECTIVE

* IEC = INTERNATIONAL ELECTROTECHNICAL COMMISSION

* CE TESTING AND EVALUATION PERFORMED BY THE UNDERWRITERS LABORATORIES AS A THIRD PARTY PARTICIPANT



LISTED 367G
IND. CONT. EQ.
WHEN USED WITH
SOCKETS 70-463-1

CURRENT LIMITED
TO RATING OF
RELAY OR SOCKET
WHICHEVER IS LESS

PLUG-IN



FLANGE MOUNT



OPTIONAL DIN MOUNT COVER



BENEFITS OF 3mm CONTACT GAP DESIGN:

- HIGH DIELECTRIC STRENGTH ACROSS CONTACTS.
- IMPROVED ARC QUENCHING WHEN BREAKING HIGH CURRENT LOADS.
- MEETS EUROPEAN SPACING REQUIREMENTS OF 8mm ACROSS SURFACES

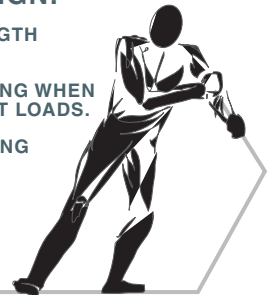
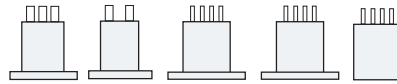

GENERAL SPECIFICATIONS (@ 25°C)

	UNITS	
COIL		
Pull-in Voltage AC (50/60 Hz):≤	% of nominal	85
Pull-in Voltage DC:≤	% of nominal	80
Dropout Voltage AC (50/60 Hz):≥	% of nominal	10
Dropout Voltage DC:≥	% of nominal	10
Maximum Voltage:	% of nominal	110
Resistance:	% ±	10
Coil Power AC (60 Hz):	VA	J: 2.75, V: 4
Coil Power DC:	W	2
Insulation System Per UL Standard 1446:		Class B (130 C)
Duty:		Continuous
CONTACTS		
Contact Material:		Silver alloy gold flashed
Contact Rating AC Amperes (AC1):	A	J: 2 Pole-20, 3 Pole-16 V: 15
Contact Rating AC Voltage:	V	240
Contact Rating DC Amperes (DC1):	A	J: 20, V: 15
Contact Rating DC Voltage:	V	28
Horse Power (AC):	HP	J: 3/4 @ 120 V V: 1/3 @ 120 V
Horse Power (AC):	HP	J: 1 @ 240 V V: 1/2 @ 240 V
Minimum Recommended Load:	ma	100 @ 5 VDC or 0.5 W

	UNITS	
DIELECTRIC STRENGTH		
Coil to Contacts:	V rms	J: 2000, V: 4000
Across Open Contacts:	V rms	J: 500, V: 1000
Pole to Pole:	V rms	2000
Contacts to Frame:	V rms	Not applicable
Insulation Resistance:	megohms minimum @ VDC	1000 @ 500
TEMPERATURE		
Operating, AC Lower:	°C	-30
Operating, AC Upper:	°C	+65
Operating, DC Lower:	°C	-30
Operating, DC Upper:	°C	+50
Storage, Lower:	°C	-30
Storage, Upper:	°C	+100
LIFE EXPECTANCY		
Electrical @ Rated Load (AC1):	operations	100,000
Mechanical @ no Load :	operations	5,000,000
MISCELLANEOUS		
Operating Position:		Any
Insulation Material:	94V-0	Molded plastic
Enclosure Material:	94V-0	Polycarbonate
Cover Protection Category:	IP	40
Terminals:	Inch (mm)	0.187x0.020 (4.74 x 0.508)
Weight:	grams	88

388J HIGH CURRENT PLUG-IN & FLANGE MOUNT RELAYS



DPDT 20 AMPS & 3PDT 16 AMPS

WIRING DIAGRAM (VIEWED FROM PIN END)

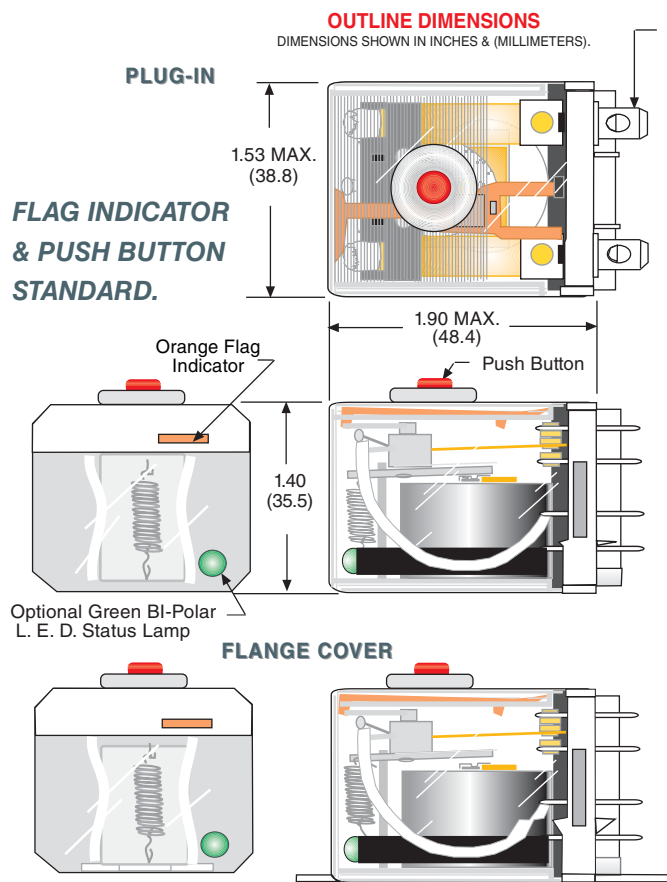

QUICK CONNECT SOLDER / PLUG-IN TERMINALS

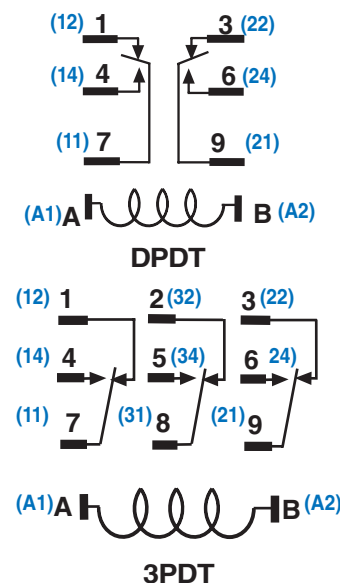
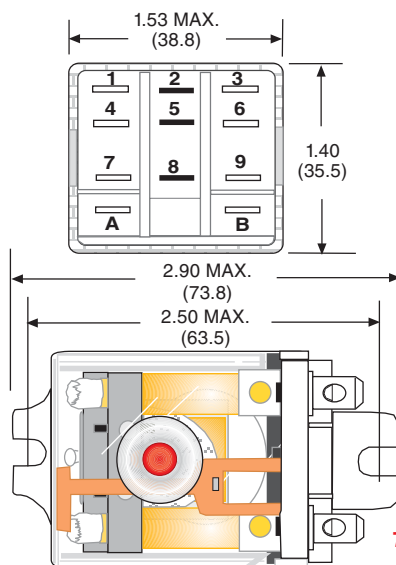

ALTERNATE NEMA
OR IEC () NUMBERS
VIEWED FROM
PIN SIDE

Mating Sockets
70-463-1: SCREW/DIN
70-124-1: SOLDER
70-178-1, 70-178-2: PRINTED CIRCUIT
70-788EL/SL-1, 70-124-2: QUICK CONNECT
See section 7

ORDERING CODE

388J XCX C1 M- 240A

CLASS: FLAG INDICATOR STANDARD FEATURE

CONTACT CONFIGURATION: DPDT: XBXC, 3PDT: XCX

OPTIONAL: MAGNETIC BLOWOUT: CODE 69 (XBXC ONLY)

CONSTRUCTION STYLE:
* ENCLOSED, PLAIN COVER: CODE C
ENCLOSED, FLANGE COVER: CODE C1
ENCLOSED TOP FLANGE MOUNT: CODE C3
ENCLOSED DIN MOUNT: CODE C4

TERMINAL STYLE: QUICK CONNECT SOLDER TERMINALS: NO CODE
PRINTED CIRCUIT TERMINALS: CODE T

OPTIONS: BI - POLAR L.E.D. STATUS LAMP: CODE L
PUSH BUTTON: CODE M

COIL VOLTAGE: 6, 12, 24, 120, 240 ADD "A" FOR AC COILS
6, 12, 24, 48, 110 ADD "D" FOR DC COILS

* Note: Code C recommended to be used with printed circuit terminals or Plug-in applications only.

STANDARD PART NUMBERS	CONTACT CONFIGURATION	COIL MEASURED @ 25 °C	
		NOMINAL INPUT VOLTAGE	NOMINAL RESISTANCE (OHMS)
AC OPERATED FLANGE MOUNT WITH PUSH BUTTON, 20 AMP			
388JXBXC1M-240A	DPDT	220/240 VAC, 50/60Hz	9100 Ω
388JXBXC1M-120A	DPDT	110/120 VAC, 50/60Hz	2250 Ω
DC OPERATED FLANGE MOUNT WITH PUSH BUTTON, 20 AMP			
388JXBXC1M-12D	DPDT	12 VDC	120 Ω
388JXBXC1M-24D	DPDT	24 VDC	470 Ω
AC OPERATED PLUG-IN WITH PUSH BUTTON, 20 AMP			
388JXBXC1M-240A	DPDT	220/240 VAC, 50/60Hz	9100 Ω
388JXBXC1M-120A	DPDT	110/120 VAC, 50/60Hz	2250 Ω
DC OPERATED PLUG-IN WITH PUSH BUTTON, 20 AMP			
388JXBXC1M-12D	DPDT	12 VDC	120 Ω
388JXBXC1M-24D	DPDT	24 VDC	470 Ω
AC OPERATED FLANGE MOUNT WITH PUSH BUTTON, 16 AMP			
388JXCXC1M-240A	3PDT	220/240 VAC, 50/60Hz	7200 Ω
388JXCXC1M-120A	3PDT	110/120 VAC, 50/60Hz	1700 Ω
DC OPERATED FLANGE MOUNT WITH PUSH BUTTON, 16 AMP			
388JXCXC1M-12D	3PDT	12 VDC	120 Ω
388JXCXC1M-24D	3PDT	24 VDC	470 Ω
AC OPERATED PLUG-IN WITH PUSH BUTTON, 16 AMP			
388JXCXC1M-240A	3PDT	220/240 VAC, 50/60Hz	7200 Ω
388JXCXC1M-120A	3PDT	110/120 VAC, 50/60Hz	1700 Ω
DC OPERATED PLUG-IN WITH PUSH BUTTON, 16 AMP			
388JXCXC1M-12D	3PDT	12 VDC	120 Ω
388JXCXC1M-24D	3PDT	24 VDC	470 Ω

RETROFITS SCHRACK RM. SEE END OF SECTION 1 FOR CROSS REFERENCE
CADMIUM-FREE CONTACTS AVAILABLE, CONTACT FACTORY FOR DETAILS

9/04

388V HIGH VOLTAGE PLUG-IN & FLANGE MOUNT RELAYS



DPST-NO & 3PST-NO 15 AMPS

WIRING DIAGRAM (VIEWED FROM PIN END)

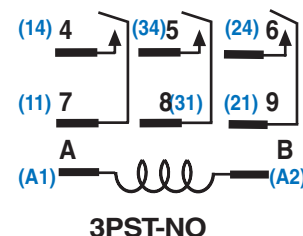
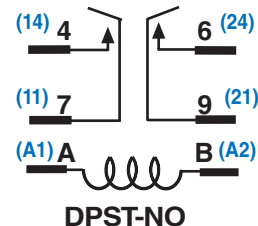

ALTERNATE NEMA
OR IEC () NUMBERS
VIEWED FROM
PIN SIDE

OUTLINE DIMENSIONS

DIMENSIONS SHOWN IN INCHES & (MILLIMETERS).

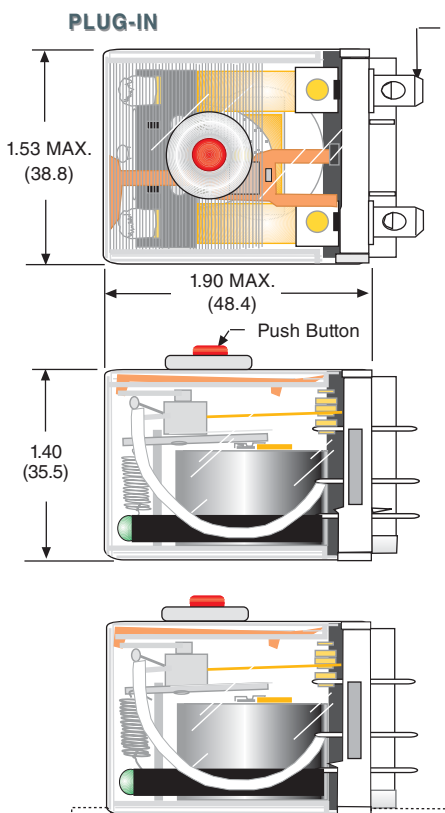

QUICK CONNECT SOLDER / PLUG-IN TERMINALS

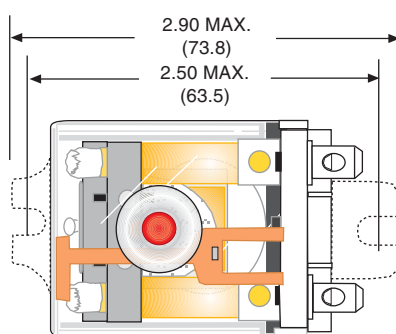
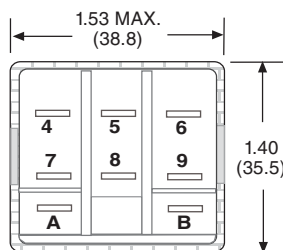

OPTIONAL FLANGE COVER

**3 MILLIMETER CONTACT GAP.
PUSH BUTTON STANDARD.**

ORDERING CODE

388V **CXX** **C1** **M-** **240A**

CLASS:

CONTACT CONFIGURATION:

DPST-NO: **BXX**
3PST-NO: **CXX**

OPTIONAL:

MAGNETIC BLOWOUT: **CODE 69 (BXX ONLY)**

CONSTRUCTION STYLE:

* ENCLOSED, PLAIN COVER: **CODE C**
ENCLOSED, FLANGE COVER: **CODE C1**
ENCLOSED TOP FLANGE MOUNT: **CODE C3**
ENCLOSED DIN MOUNT: **CODE C4**

TERMINAL STYLE:

QUICK CONNECT SOLDER/PLUG-IN TERMINALS:
NO CODE
PRINTED CIRCUIT TERMINALS: **CODE T**

OPTIONS:

BI - POLAR L.E.D. STATUS LAMP: **CODE L**
PUSH BUTTON: **CODE M**

COIL VOLTAGE:

6, 12, 24, 120, 220/240 **ADD "A" FOR AC COILS**
6, 12, 24, 48, 110 **ADD "D" FOR DC COILS**

* Note: Code C recommended to be used with printed circuit terminals or Plug-in applications only.



Mating Sockets

70-463-1: **SCREW/DIN**

70-124-1: **SOLDER**

70-178-1, 70-178-2: **PRINTED CIRCUIT**

0-788EL/SL-1, 70-124-2: **QUICK CONNECT**

See section 7

STANDARD PART NUMBERS	CONTACT CONFIGURATION	COIL MEASURED @ 25 °C	
		NOMINAL INPUT VOLTAGE	NOMINAL RESISTANCE (OHMS)
AC OPERATED PLUG-IN WITH PUSH BUTTON 3mm GAP, 15 AMP			
388VCXXCM-220/240A	3PST-NO	220/240 VAC, 50/60Hz	9100 Ω
388VCXXCM-120A	3PST-NO	110/120 VAC, 50/60Hz	1100 Ω
388VCXXCM-24A	3PST-NO	24 VAC, 50/60Hz	75 Ω
388VBXXCM-220/240A	DPST-NO	220/240 VAC, 50/60Hz	9100 Ω
388VBXXCM-120A	DPST-NO	110/120 VAC, 50/60Hz	1100 Ω
388VBXXCM-24A	DPST-NO	24 VAC, 50/60 Hz	75 Ω
DC OPERATED PLUG-IN WITH PUSH BUTTON 3mm GAP, 15 AMP			
388VCXXCM-24D	3PST-NO	24 VDC	240 Ω
388VCXXCM-12D	3PST-NO	12 VDC	120 Ω
388VBXXCM-24D	DPST-NO	24 VDC	240 Ω
388VBXXCM-12D	DPST-NO	12 VDC	120 Ω

RETROFITS POTTER & BRUMFIELD KUGP.
SEE END OF SECTION 1 FOR CROSS REFERENCE

FEATURES

OVERSIZE CURRENT CARRYING PARTS

600 VOLT SPACING

FULL RANGE OF CONTACT RATINGS

BROAD SELECTION OF MOUNTING STYLES & OPTIONS

BENEFITS

RUNS COOLER & LONGER

HANDLES MOST LOAD VOLTAGES

ELIMINATES "GUESS WORK"

CAN BE "CUSTOMIZED" FOR UNIQUE SITUATIONS



COMPLIES WITH REQUIREMENTS OF

- * IEC STANDARDS 947-4-1 AND 947-5-1 LOW VOLTAGE DIRECTIVE
- * IEC = INTERNATIONAL ELECTROTECHNICAL COMMISSION
- * CE TESTING AND EVALUATION PERFORMED BY THE UNDERWRITERS LABORATORIES AS A THIRD PARTY PARTICIPANT

DIELECTRIC STRENGTH CHART (V rms)

MANUFACTURED
UNDER
ISO 9002
& QS 9000

CONTACT CONFIGURATION	ACROSS OPEN CONTACTS	COIL TO CONTACTS	POLE TO POLE
SPST	1000	2200	-
DPDT	1000	2200	2200
3PDT	1000	1600	1600
SPDT (DB and DM)	1500	2200	-

STANDARD SIDE FLANGE COVER



389F WITH PUSH BUTTON AND FLAG



OPTIONAL TOP FLANGE COVER



OPTIONAL DIN COVER



GENERAL SPECIFICATIONS (@ 25°C)

	UNITS	
COIL		
Pull-in Voltage AC (50/60 Hz): ≤	% of nominal	85
Pull-in Voltage DC: ≤	% of nominal	80
Dropout Voltage AC (50/60 Hz): ≥	% of nominal	10
Dropout Voltage DC: ≥	% of nominal	10
Maximum Voltage:	% of nominal	110
Resistance:	% ±	10
Coil Power AC (60 Hz):	VA	3.5
Coil Power DC:	W	1.44
Insulation System Per UL Standard 1446:		Class B (130 °C)
Duty:		Continuous
CONTACTS		
Contact Material:		Silver alloy gold flashed
Contact Rating AC Amperes (AC1):	A	20, 25, 30 see load tables
Pilot Duty:		A600, B600
VA Rating Make:	VA	600
VA Rating Break:	VA	60
Minimum Recommended Load:	ma	100 @ 5 VDC or 0.5 W
DIELECTRIC STRENGTH		
Coil to Contacts:	V rms	1600
Across Open Contacts:	V rms	1000
Pole to Pole:	V rms	1600
Contacts to Frame:	V rms	Not applicable
Insulation Resistance:	megohms minimum @VDC	1000 @ 500

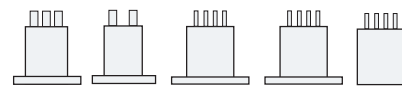

	UNITS	
TEMPERATURE		
Operating, AC Lower:	°C	-30
Operating, AC Upper:	°C	+65
Operating, DC Lower:	°C	-30
Operating, DC Upper:	°C	+50
Storage, Lower:	°C	-30
Storage, Upper:	°C	+100
LIFE EXPECTANCY		
Electrical @ Rated Load (AC1):	operations	100,000
Mechanical @ no Load :	operations	5,000,000
MISCELLANEOUS		
Operating Position:		Any
Insulation Material:	94V-0	Molded plastic
Enclosure Material:	94V-0	Polycarbonate
Cover Protection Category:	IP	40
Terminals:	Inch (mm)	0.250, 0.09 x 0.032 (6.35, 2.29 x 0.81)
Weight:	grams	88

389 & 389F FLANGE MOUNT POWER RELAYS



20, 25 & 30 AMPS

OUTLINE DIMENSIONS

DIMENSIONS SHOWN IN INCHES & (MILLIMETERS).

**QUICK CONNECT
SOLDER / PLUG-IN TERMINALS**

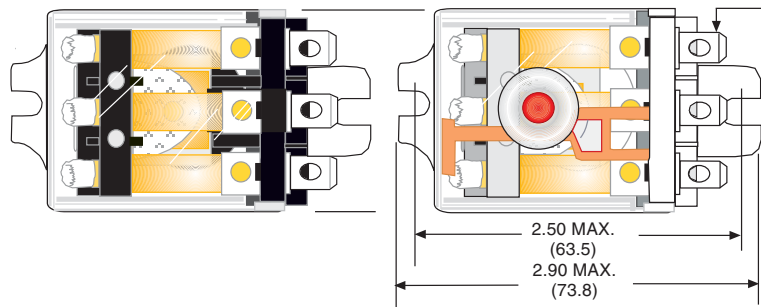

**PRINTED CIRCUIT
MOUNTING HOLE LAYOUT
(TOP VIEW)**

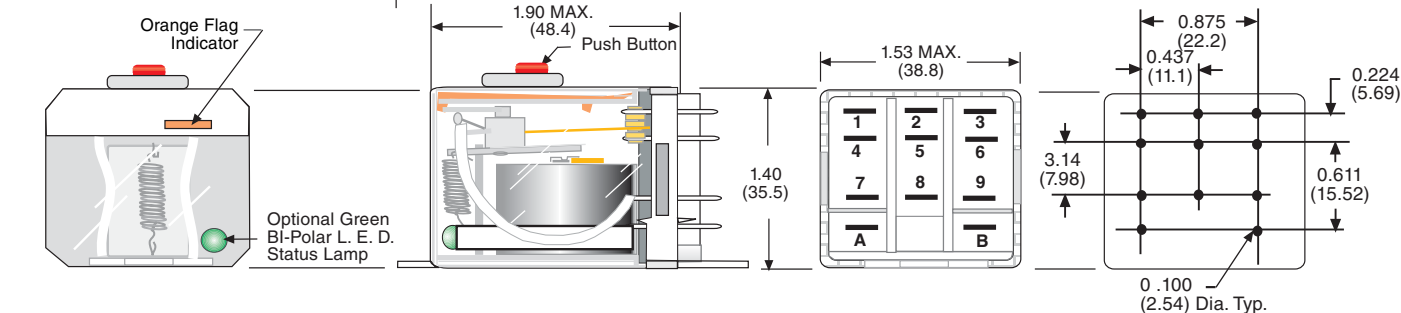

CLASS 389 LOAD RATINGS

CONTACT CONFIGURATION	CURRENT OR HORSE POWER	LOAD VOLTAGE	LOAD VOLTAGE FREQUENCY	TYPE OF LOAD
SPDT	13A	28	DC	RESISTIVE
	20A	15	DC	RESISTIVE
	25A	300	50/60 Hz	RESISTIVE
	5A	600	50/60 Hz	RESISTIVE
	20A	277	50/60 Hz	BALLAST
	1HP	120	50/60 Hz	MOTOR
	1-1/2HP	208/240	50/60 Hz	MOTOR
	1HP	480/600	50/60 Hz	MOTOR
	660VA	120	50/60 Hz	PILOT DUTY
	960VA	240	50/60 Hz	PILOT DUTY
DPDT	B600		50/60Hz	PILOT DUTY
	13A	28	DC	RESISTIVE
	20A	15	DC	RESISTIVE
	25A	300	50/60 Hz	RESISTIVE
	5A	600	50/60 Hz	RESISTIVE
	20A	277	50/60 Hz	BALLAST
	1HP	120	50/60 Hz	MOTOR
	1-1/2HP	208/240	50/60 Hz	MOTOR
	1HP	480/600	50/60 Hz	MOTOR
	660VA	120	50/60 Hz	PILOT DUTY
3PDT	960VA	240	50/60Hz	PILOT DUTY
	B600		50/60Hz	PILOT DUTY
	13A	28	DC	RESISTIVE
	15A	28	DC (NO)	RESISTIVE
	20A	15	DC	RESISTIVE
	20A	150	50/60 Hz	RESISTIVE
	††15A	250	50/60 Hz	RESISTIVE
	†10A	300	50/60 Hz	RESISTIVE
	20A	150	50/60 Hz	BALLAST
	6-2/3A	277	50/60 Hz	BALLAST
3PDT	1/2HP	120	50/60Hz	MOTOR
	1/2HP	208/240	50/60 Hz	MOTOR
	1HP	240	50/60 Hz	MOTOR
	3/4HP	120	50/60Hz	MOTOR
	470VA	120/240	50/60Hz	PILOT DUTY
	B300		50/60Hz	PILOT DUTY

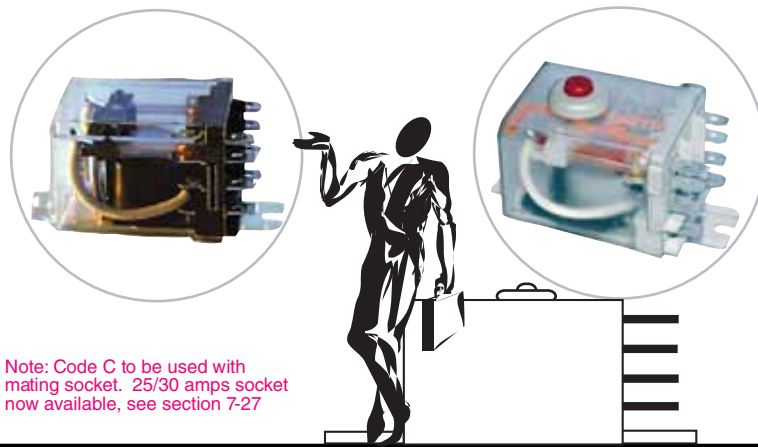

Note: Code C to be used with mating socket. 25/30 amps socket now available, see section 7-27

CLASS 389D LOAD RATINGS

CONTACT CONFIGURATION	CURRENT OR HORSE POWER	LOAD VOLTAGE	LOAD VOLTAGE FREQUENCY	TYPE OF LOAD
SPST (NO-DM)	30A	28	DC	RESISTIVE
	30A	300	50/60 Hz	RESISTIVE
	10A	600	50/60 Hz	RESISTIVE
	1HP	120	50/60 Hz	MOTOR
	1-1/2HP	200 thru 600	50/60 Hz	MOTOR
	765VA	120	50/60 Hz	PILOT DUTY
	960VA	240,480,600	50/60 Hz	PILOT DUTY
	A600		50/60 Hz	PILOT DUTY
SPDT (DB and DM)	25 A	277	50/60 Hz	BALLAST

†† UL APPLIANCE RATED. ALL OTHER RATINGS NOT SO MARKED ARE INDUSTRIAL RATED
† CSA RATING ONLY, NOT UL



389 & 389F FLANGE MOUNT POWER RELAYS



20, 25 & 30 AMPS

WIRING DIAGRAM
(VIEWED FROM PIN END)

ORDERING CODE

389F **XCX** **C1** **M** **-120A**

CLASS:

FLAG INDICATOR
STANDARD FEATURE

CONTACT CONFIGURATION:

DPDT: **XBX**, 3PDT: **XCX**

OPTIONAL:

MAGNETIC BLOWOUT:
CODE 69 (XBX ONLY)

CONSTRUCTION STYLE:

* ENCLOSED, PLAIN COVER: CODE C
ENCLOSED, FLANGE COVER: CODE C1
ENCLOSED TOP FLANGE MOUNT: CODE C3
ENCLOSED DIN MOUNT: CODE C4

TERMINAL STYLE:

0.250 QUICK CONNECT
SOLDER TERMINALS: NO CODE
PRINTED CIRCUIT TERMINALS: CODE T

OPTIONS:

BI - POLAR L.E.D. STATUS LAMP: CODE L
PUSH BUTTON: CODE M

COIL VOLTAGE:

6, 12, 24, 120, 240 ADD "A" FOR AC COILS
6, 12, 24, 48, 110 ADD "D" FOR DC COILS

* Note: Code C to be used with mating socket. 25/30 amps socket now available, see section 7-27

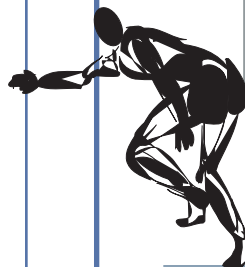

389

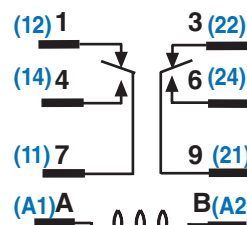

DPDT

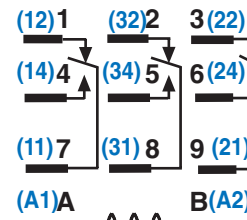

3PDT

ALTERNATE NEMA
OR IEC () NUMBERS
VIEWED FROM
PIN SIDE

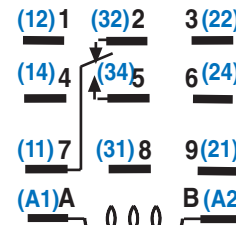

SPDT

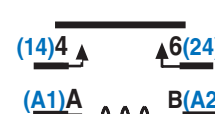

SPST-NO-DM



SPDT-NC-NO-DB-DM



389F

STANDARD PART NUMBERS	CONTACT CONFIGURATION	COIL MEASURED @ 25 °C	
		NOMINAL INPUT VOLTAGE	NOMINAL RESISTANCE (OHMS)
AC OPERATED FLANGE MOUNT WITH PUSH BUTTON, 25 AMP			
389FXBXC1M-240A	DPDT	220/240 VAC, 50/60Hz	7200 Ω
389FXBXC1M-120A	DPDT	110/120 VAC, 50/60Hz	1700 Ω
AC OPERATED FLANGE MOUNT WITH PUSH BUTTON, 20 AMP			
389FXCXC1M-240A	3PDT	220/240 VAC, 50/60Hz	4600 Ω
389FXCXC1M-120A	3PDT	110/120 VAC, 50/60Hz	1200 Ω
DC OPERATED FLANGE MOUNT WITH PUSH BUTTON, 25 AMP			
389FXBXC1M-12D	DPDT	12 VDC	100 Ω
389FXBXC1M-24D	DPDT	24 VDC	400 Ω
DC OPERATED FLANGE MOUNT WITH PUSH BUTTON, 20 AMP			
389FXCXC1M-12D	3PDT	12 VDC	100 Ω
389FXCXC1M-24D	3PDT	24 VDC	400 Ω

RETROFITS SCHRACK RM.
SEE END OF SECTION 1 FOR CROSS REFERENCE

STANDARD PART NUMBERS	CONTACT CONFIGURATION	COIL MEASURED @ 25 °C	
		NOMINAL INPUT VOLTAGE	NOMINAL RESISTANCE (OHMS)
AC OPERATED FLANGE MOUNT, 30 AMP			
W389ADCX-4	SPST-NO (DM)	110/120 VAC, 50/60Hz	1100 Ω
W389ADCX-5	SPST-NO (DM)	220/240 VAC, 50/60Hz	4300 Ω
W389ADZCX-3	SPDT-NO-NC (DB-DM)	24 VAC, 50/60Hz	44 Ω
W389ADZCX-4	SPDT-NO-NC (DB-DM)	110/120 VAC, 50/60Hz	1100 Ω
DC OPERATED FLANGE MOUNT, 30 AMP			
W389DCX-2	SPST-NO (DM)	12 VDC	100 Ω
W389DCX-3	SPST-NO (DM)	24 VDC	400 Ω
W389DZCX-2	SPST-NO-NC (DB-DM)	12 VDC	100 Ω
W389DZCX-3	SPST-NO-NC (DB-DM)	24VDC	400 Ω

AC OPERATED FLANGE MOUNT, 25 AMP			
W389ACX-4	SPDT	110/120 VAC, 50/60Hz	1700 Ω
W389ACX-8	DPDT	24 VAC, 50/60Hz	72 Ω
W389ACX-9	DPDT	110/120 VAC, 50/60Hz	1700 Ω
W389ACX-10	DPDT	220/240 VAC, 50/60Hz	7200 Ω
AC OPERATED FLANGE MOUNT, 20 AMP			
W389ACX-14	3PDT	110/120 VAC, 50/60Hz	1200 Ω
W389ACX-15	3PDT	220/240 VAC, 50/60Hz	4600 Ω
DC OPERATED FLANGE MOUNT, 25 AMP			
W389CX-2	SPDT	12 VDC	100 Ω
W389CX-3	SPDT	24VDC	400 Ω
W389CX-7	DPDT	12 VDC	100 Ω
W389CX-8	DPDT	24VDC	400 Ω
DC OPERATED FLANGE MOUNT, 20 AMP			
W389CX-12	3PDT	12 VDC	100 Ω
W389CX-13	3PDT	24VDC	400 Ω

RETROFITS POTTER & BRUMFIELD KUMP & KUHP.
SEE END OF SECTION 1 FOR CROSS REFERENCE

FEATURES

2 MILLIMETER CONTACT GAPS AND 8 MILLIMETER CREEPAGE AND CLEARANCE

WIDE SPACING BETWEEN STATIONARY CONTACT TERMINALS

ARC BARRIERS BETWEEN CONTACTS

OPTIONAL BLOWOUT MAGNET

IMPROVED DIELECTRIC STRENGTH BETWEEN CONTACT

WIDE SELECTION OF MOUNTING OPTIONS

BENEFITS

MEETS INTERNATIONAL REQUIREMENTS.

CLEARANCE FOR FULLY BOOTED QUICK CONNECT TERMINALS

IMPROVED DIELECTRIC STRENGTH BETWEEN CONTACT SETS.

HIGH VOLTAGE DC SWITCHING

4000 Vrms DIELECTRIC BETWEEN MUTUALLY INSULATED CONDUCTIVE ELEMENTS AND FRAME.

ALLOWS INSTALLATIONS TO BE "CUSTOMIZED"



COMPLIES WITH REQUIREMENTS OF

* IEC STANDARDS 947-4-1 AND 947-5-1 LOW VOLTAGE DIRECTIVE

* IEC = INTERNATIONAL ELECTROTECHNICAL COMMISSION

* CE TESTING AND EVALUATION PERFORMED BY THE UNDERWRITERS LABORATORIES AS A THIRD PARTY PARTICIPANT

MANUFACTURED
UNDER
ISO 9002
& QS 9000

STANDARD SIDE FLANGE COVER

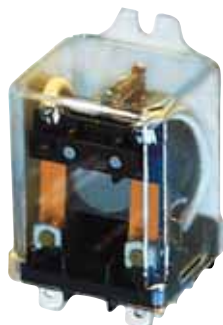

OPTIONAL TOP FLANGE MOUNT COVER

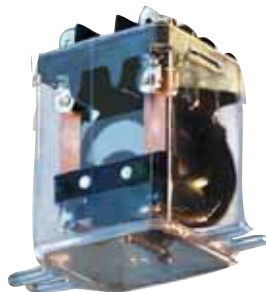

OPTIONAL DIN MOUNT COVER



GENERAL SPECIFICATIONS (@ 25°C)

	UNITS	
COIL		
Pull-in Voltage AC (50/60 Hz):≤	% of nominal	85
Pull-in Voltage DC:≤	% of nominal	80
Dropout Voltage AC (50/60 Hz):≥	% of nominal	10
Dropout Voltage DC:≥	% of nominal	10
Maximum Voltage:	% of nominal	110
Resistance:	% ±	10
Coil Power AC (60 Hz):	VA	3
Coil Power DC:	W	2
Insulation System Per UL Standard 1446:		Class B (130 °C) or Class F (155 °C)
Duty:		Continuous
CONTACTS		
Contact Material:		Silver alloy gold flashed
Contact Rating AC Amperes (AC1):	A	30 / 20 / 15
Contact Rating AC Voltage:	V	277 / 600
Contact Rating DC Amperes (DC1):	A	30
Contact Rating DC Voltage:	V	28
Horse Power (AC):	HP	1 @ 120
Horse Power (AC):	HP	2 @ 208 - 600
Minimum Recommended Load:	ma	100 @ 5 VDC or 0.5 W
TIMING		
Operate Time:	ms	20
Release Time:	ms	15

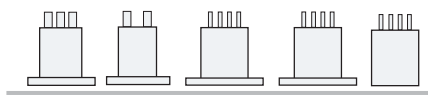

	UNITS	
DIELECTRIC STRENGTH		
Coil to Contacts:	V rms	4000
Across Open Contacts:	V rms	1000
Pole to Pole:	V rms	1000
Contacts to Frame:	V rms	Not applicable
Insulation Resistance:	megohms minimum @VDC	1000 @ 500
TEMPERATURE		
Operating, AC Lower:	°C	-30
Operating, AC Upper:	°C	+60
Operating, DC Lower:	°C	-30
Operating, DC Upper:	°C	+50
Storage, Lower:	°C	-40
Storage, Upper:	°C	+105
LIFE EXPECTANCY		
Electrical @ Rated Load (AC1):	operations	100,000
Mechanical @ no Load :	operations	10,000,000
MISCELLANEOUS		
Operating Position:		Any
Insulation Material:	94V-0	Molded plastic
Enclosure Material:	94V-0	Polycarbonate
Cover Protection Category:	IP	40
Terminals:	Inch (mm)	0.250, 0.09 x 0.032 (6.35, 2.29 x 0.81)
Weight:	grams	85

300 HIGH CURRENT & HIGH VOLTAGE POWER RELAY



DPDT, UP TO 30 AMPS UP TO 600 VAC OR 150 VDC

WIRING DIAGRAM (VIEWED FROM PIN END)

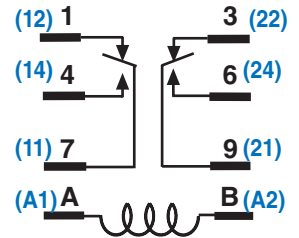

ALTERNATE NEMA
OR IEC () NUMBERS
VIEWED FROM
PIN SIDE

OUTLINE DIMENSIONS

DIMENSIONS SHOWN IN INCHES & (MILLIMETERS).

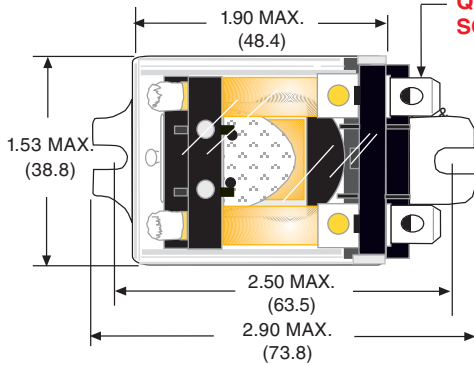

QUICK CONNECT SOLDER TERMINALS

PRINTED CIRCUIT TERMINALS

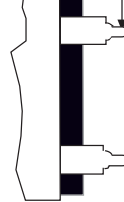

PRINTED CIRCUIT MOUNTING HOLE LAYOUT (TOP VIEW)

ENCLOSED FLANGE MOUNT

Optional Push Button

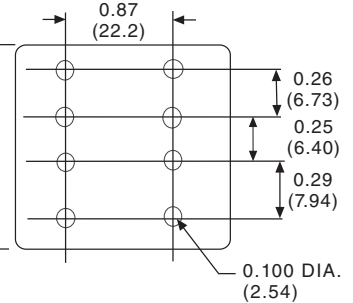
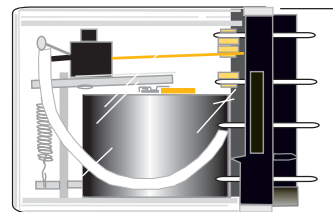
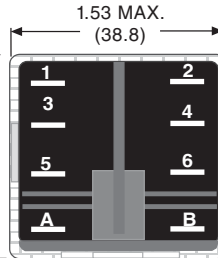
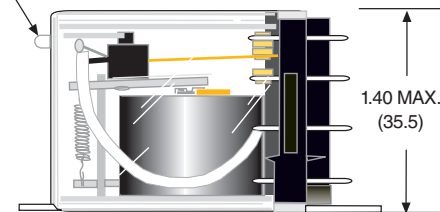

ORDERING CODE

F **300** **XBX** **C1** **LM** **-24D**

TEMPERATURE RATING:

130°C COIL (CLASS B): **NO CODE**
155°C COIL (CLASS F): **CODE F**

CLASS:

CONTACT CONFIGURATION:

DPDT: **XBX**
SPDT-DB-DM: **XHX**

OPTIONAL:

MAGNETIC BLOWOUT :**CODE 69**

CONSTRUCTION STYLE:

* ENCLOSED, PLAIN COVER: **CODE C**
ENCLOSED, FLANGE COVER: **CODE C1**
ENCLOSED TOP FLANGE MOUNT: **CODE C3**
ENCLOSED DIN MOUNT: **CODE C4**

TERMINAL STYLE:

QUICK CONNECT SOLDER TERMINALS: **NO CODE**
PRINTED CIRCUIT TERMINALS: **CODE T**

OPTIONS:

BI - POLAR L.E.D. STATUS LAMP: **CODE L**
PUSH BUTTON: **CODE M**

COIL VOLTAGE:

6, 12, 24, 120, 240 **ADD "A" FOR AC COILS**
6, 12, 24, 48, 110 **ADD "D" FOR DC COILS**

* Note: Code C recommended to be used with printed circuit terminals only.

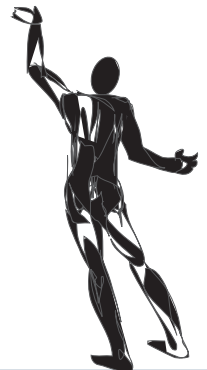

STANDARD PART NUMBERS	CONTACT CONFIGURATION	COIL MEASURED @ 25 °C	
		NOMINAL INPUT VOLTAGE	NOMINAL RESISTANCE (OHMS)
AC OPERATED, 30 AMP			
300XBXC1-240A	DPDT	220/240 VAC, 50/60Hz	5400 Ω
300XBXC1-120A	DPDT	110/120 VAC, 50/60Hz	1270 Ω
300XBXC1-24A	DPDT	24 VAC, 50/60Hz	54 Ω
300XBXC1-12A	DPDT	12 VAC, 50/60Hz	13.5 Ω
DC OPERATED, 30 AMP			
300XBXC1-110D	DPDT	110/125 VDC	6300 Ω
300XBXC1-24D	DPDT	24 VDC	300 Ω
300XBXC1-12D	DPDT	12 VDC	75 Ω
DC OPERATED, 30 AMP WITH MAGNETIC BLOWOUT			
300XBX69C1-110D	DPDT	110/125 VDC	6300 Ω
300XBX69C1-24D	DPDT	24 VDC	300 Ω
300XBX69C1-12D	DPDT	12 VDC	75 Ω



UL CONTACT LOAD RATINGS TABLE FOR 9A

LOAD	LOAD VOLTAGE	SPST	SPDT	
		N.O. LOAD	N.O. LOAD	N.C. LOAD
GENERAL PURPOSE	240 VAC	30 AMP	20 AMP	10 AMP
RESISTIVE	28 VDC	30 AMP	30 AMP	10 AMP
MOTOR	125 VAC	1 HP	1 HP	1/4 HP
	240 VAC	2 HP	2 HP	1/2 HP
FLA/LRA ‡	120 VAC	22/98 AMP	22/98 AMP	-
	240 VAC	30/80 AMP	30/80 AMP	12/30 AMP
TUNGSTEN	240 VAC	5 AMP	5 AMP	-
BALLAST	277 VAC	10 AMP	10 AMP	3 AMP
PILOT DUTY	240 VAC	470 VA	470 VA	275 VA

‡ FLA = Full load amps,
LRA = Locked rotor amps.

UL CONTACT LOAD RATINGS TABLE FOR 92

RATING	LOAD VOLTAGE	DPST-N.O. & DPDT	DPDT
		N.O. LOAD	N.C. LOAD
RESISTIVE LOAD	120/277 VAC	30 AMP	3 A MP
	28 VDC	20 AMP	3 A MP
MOTOR	120 VAC	1 HP	-
	240 VAC	3 HP	-
TUNGSTEN	120 VAC	10 AMP	-
LRA/FLA‡	240 VAC	96/22	-
		110/25.3	-
PILOT DUTY	240 VAC	3 AMP	-



CLASS "F" INSULATION 155 °C. FLANGE MOUNTED.
EPOXY SEALED WITH REMOVABLE TAPE SEAL OVER VENT HOLE (REMOVED AFTER CLEANING)

GENERAL SPECIFICATIONS (@ 25°C)

	UNITS	
COIL		
Pull-in Voltage AC (50/60 Hz):≤	% of nominal	80
Pull-in Voltage DC:≤	% of nominal	75
Dropout Voltage AC (50/60 Hz):≥	% of nominal	10
Dropout Voltage DC:≥	% of nominal	10
Maximum Voltage:	% of nominal	120
Resistance:	% ±	10
Coil Power AC (60 Hz):	VA	9A: 2.8, 92: 4
Coil Power DC:	W	9A: 1, 92: 1.7
Insulation System Per UL Standard 1446:		Class F (155 °C)
Duty:		Continuous
CONTACTS		
Contact Configuration:		9A: SPST-NO & SPDT 92: DPST-NC & DPDT
Contact Material:		Silver alloy
Contact Rating AC Amperes (AC1):	A	30
Contact Rating AC Voltage:	V	9A: 240, 92: 277
Contact Rating DC Amperes (DC1):	A	9A: 30, 92: 20
Contact Rating DC Voltage:	V	28
Horse Power (AC):	HP	9A: 1 @ 120, 2 @ 240 VAC
Horse Power (AC):	HP	92: 1 @ 120, 3 @ 240 VAC
Pilot Duty (60 Hz):	VA	9A: 470, 92: 720
Minimum Recommended Load:	ma	100 @ 5 VDC or 0.5 W
TIMING		
Operate Time:	ms	20
Release Time:	ms	20

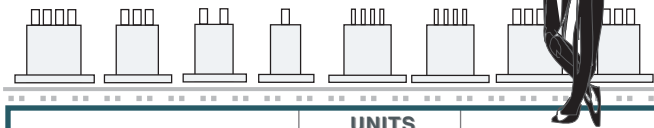

	UNITS	
DIELECTRIC STRENGTH		
Coil to Contacts:	V rms	2500
Across Open Contacts:	V rms	1500
Pole to Pole:	V rms	9A: Not applicable 92: 2500
Contacts to Frame:	V rms	Not Applicable
Insulation Resistance:	megohms minimum @VDC	1000 @ 500
VIBRATION RESISTANCE		
Functional:	g's	10
SHOCK RESISTANCE		
Functional:	g's	20
TEMPERATURE		
Operating, AC Lower:	°C	-55
Operating, AC Upper:	°C	+85
Operating, DC Lower:	°C	-55
Operating, DC Upper:	°C	+85
Storage, Lower:	°C	-55
Storage, Upper:	°C	+105
LIFE EXPECTANCY		
Electrical @ Rated Load (AC1):	operations	100,000
Mechanical @ no Load :	operations	9A: 10,000,000 92: 5,000,000
MISCELLANEOUS		
Operating Position:		Any
Insulation Material:	94V-0	Molded plastic
Enclosure Material:	94V-0	Polycarbonate
Cover Protection Category:	IP	40
Terminals:	Inch (mm)	92: 0.250 x 0.032 (6.35 x 0.81)
Weight:	grams	9A: 33, 92: 86

9A FLANGE MOUNT MINIATURE RELAY



SPST-N.O. & SPDT, 30 AMPS

WIRING DIAGRAM
(VIEWED FROM PIN END)

OUTLINE DIMENSIONS

DIMENSIONS SHOWN IN INCHES & (MILLIMETERS).

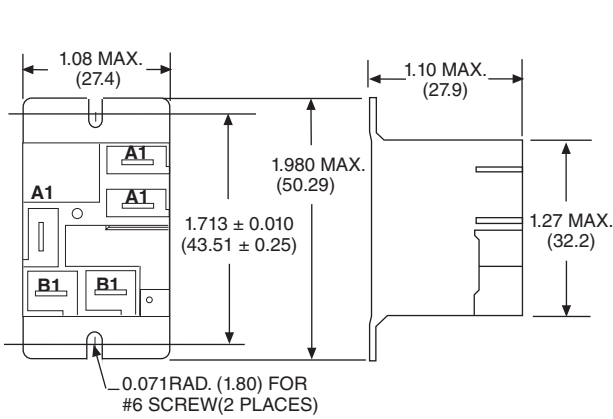

WITH OPTIONAL DIN ADAPTER

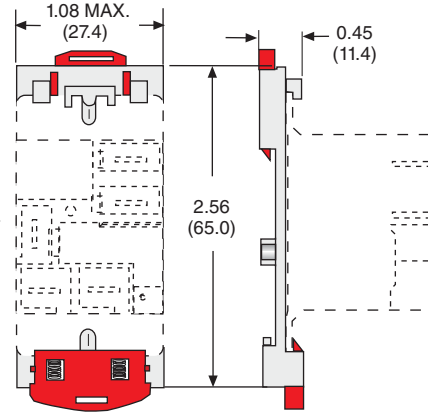

A1 = 0.250 X 0.032 (6.35 X 0.81)
Quick Connect Terminal

B1 = 0.187 x 0.020 (4.78 x 0.508)
Quick Connect Terminal

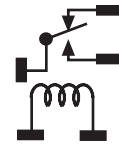

FIG. A

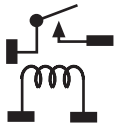

FIG. D

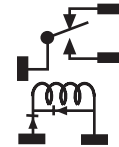

FIG. B

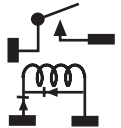

FIG. E



FIG. C

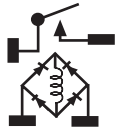

FIG. F



STANDARD
FLANGE COVER



OPTIONAL DIN
ADAPTER
16-9A DIN-1

ORDERED AND SHIPPED
SEPARATELY

MEETS UL 873 AND UL 508
SPACING - (8MM) THRU AIR,
(9.5 MM) OVER SURFACE

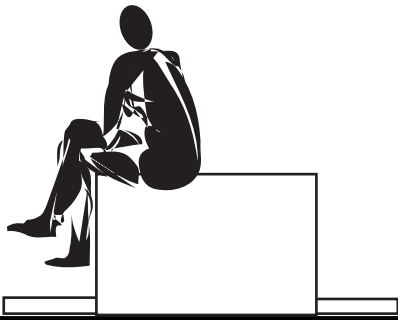

STANDARD PART NUMBERS	CONTACT CONFIGURATION	FIG.	COIL MEASURED @ 25 °C	
			NOMINAL INPUT VOLTAGE	NOMINAL RESISTANCE (OHMS)
FLANGE MOUNT, 30 AMP				
W9AS1D52-5	SPST-NO	A	5 VDC	25 Ω
W9AS1D52-12	SPST-NO	A	12 VDC	144 Ω
W9AS1D52-24	SPST-NO	A	24 VDC	576 Ω
W9AS1D52-110	SPST-NO	A	110/125 VDC	12100 Ω
FLANGE MOUNT, 20 AMP				
W9AS5D52-5	SPDT	D	5 VDC	25 Ω
W9AS5D52-12	SPDT	D	12 VDC	144 Ω
W9AS5D52-24	SPDT	D	24 VDC	576 Ω
W9AS5D52-110	SPDT	D	110/125 VDC	12100 Ω
FLANGE MOUNT, 30 AMP				
W9AS1A52-24	SPST-NO	F	24 VAC, 50/60 Hz	500 Ω
W9AS1A52-120	SPST-NO	E	120 VAC, 50/60 Hz	3,000 Ω
W9AS1A52-240	SPST-NO	E	240 VAC, 50/60 Hz	12,100 Ω
FLANGE MOUNT, 20 AMP				
W9AS5A52-24	SPDT	C	24 VAC, 50/60 Hz	500 Ω
W9AS5A52-120	SPDT	B	120 VAC, 50/60 Hz	3,000 Ω
W9AS5A52-240	SPDT	B	240 VAC, 50/60 Hz	12,100 Ω

92 FLANGE / DIN MOUNT POWER RELAY



DPST-N.O. & DPDT 30 AMPS

WIRING DIAGRAM (VIEWED FROM PIN END)

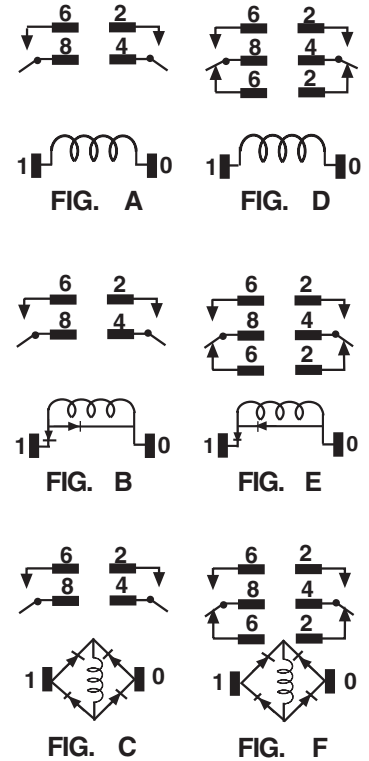

NEW

OUTLINE DIMENSIONS DIMENSIONS SHOWN IN INCHES & (MILLIMETERS).

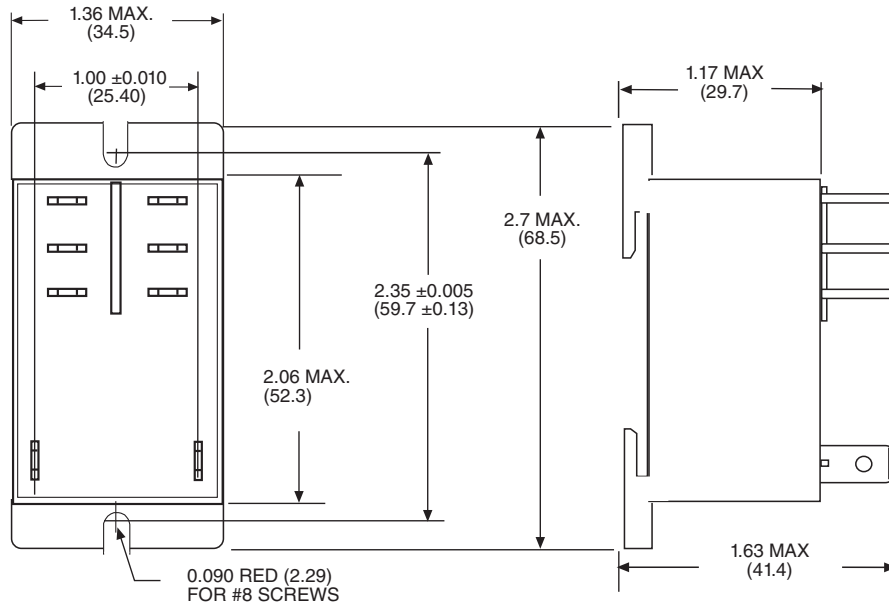

**IMPROVED FLANGE
COVER WITH DIN**

**MEETS UL 873, UL 508 AND UL
1950 - (0.125 MM) THRU AIR,
(0.25 MM) OVER SURFACE**

DIN MOUNT PART NUMBERS	SUPERCEDES PART NUMBERS	FIG.	CONTACT CONFIGURATION	COIL MEASURED @ 25 °C	
				NOMINAL INPUT VOLTAGE	NOMINAL RESISTANCE (OHMS)
AC OPERATED COIL FLANGE MOUNT, 30 AMP					
DUAL MARKED					
W92S7A22D-24	W92S7A22-24	C	DPST-NO	24 VAC, 50/60 Hz	250 Ω
W92S7A22D-120	W92S7A22-120	B	DPST-NO	120 VAC, 50/60 Hz	1,600 Ω
W92S7A22D-240	W92S7A22-240	B	DPST-NO	240 VAC (50/60 Hz)	6,500 Ω
W92S11A22D-24	W92S11A22-24	F	DPDT	24 VAC, 50/60 Hz	250 Ω
W92S11A22D-120	W92S11A22-120	E	DPDT	120 VAC, 50/60 Hz	1,600 Ω
W92S11A22D-240	W92S11A22-240	E	DPDT	240 VAC, 50/60 Hz	6,500 Ω
DC OPERATED COIL FLANGE MOUNT, 30 AMP					
W92S7D22D-12	W92S7D22-12	A	DPST-NO	12 VDC	86 Ω
W92S7D22D-24	W92S7D22-24	A	DPST-NO	24 VDC	350 Ω
W92S7D22D-110	W92S7D22-110	A	DPST-NO	110/125 VDC	7,255 Ω
W92S11D22D-12	W92S11D22-12	D	DPDT	12 VDC	86 Ω
W92S11D22D-24	W92S11D22-24	D	DPDT	24 VDC	350 Ω
W92S11D22D-110	W92S11D22-110	D	DPDT	110/125 VDC	7,255 Ω



DPDT, 30 AMPS

WIRING DIAGRAM (VIEWED FROM PIN END)

— **BENEFITS** — **MAGNECRAFT: W21ACPX-2** (UL RECOGNIZED) — **MIDTEX: TYPE 136** (NOT UL RECOGNIZED) —

CURRENT RATING:	30 AMPS @ 120 / 240 VAC, 20 AMPS @ 28 VDC	15 AMPS @ 120 VAC, 15 AMPS @ 28 VDC
HORSEPOWER RATING:	1-1/2 HP @ 120 VAC, 2 HP @ 240 VAC	1/4 HP @ 120 VAC, NOT UL RATED
TUNGSTEN LOAD RATING:	2.4 KW @ 120 / 240 VAC	1 KW @ 120 / 240 VAC
ELECTRICAL LIFE @ RATED LOAD:	200,000 OPERATIONS	100,000 OPERATIONS

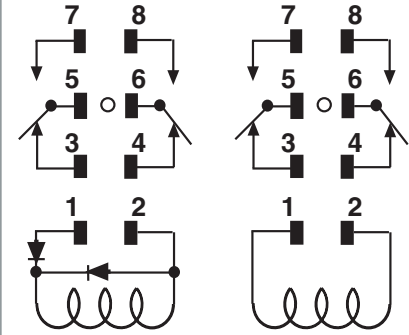

21

136

RECTIFIED COIL

MANUFACTURED UNDER ISO 9001

GENERAL SPECIFICATIONS (@ 25°C)

	UNITS	
COIL		
Pull-in Voltage AC (50/60 Hz):≤	% of nominal	65
Pull-in Voltage DC:≤	% of nominal	Not Applicable
Dropout Voltage AC (50/60 Hz):≥	% of nominal	10
Dropout Voltage DC:≥	% of nominal	Not Applicable
Maximum Voltage:	% of nominal	10
Resistance:	% ±	Not Applicable
Insulation System Per UL Standard 1446:		Class B (130 °C)
CONTACTS		
Contact Material:		Silver alloy
Contact Rating AC Amperes (AC1):	A	30
Contact Rating AC Voltage:	V	240
Contact Rating DC Amperes (DC1):	A	20
Contact Rating DC Voltage:	V	28
Horse Power (AC):	Hp	1 1/2 @ 120 V
Horse Power (AC):	Hp	2 @ 240 V
Minimum Recommended Load:	ma	100 @ 5 VDC or 0.5 W
TIMING		
Operate Time:	ms	20
Release Time:	ms	20
DIELECTRIC STRENGTH		
Coil to Contacts:	V rms	1500
Across Open Contacts:	V rms	500
Pole to Pole:	V rms	1500
Contacts to Frame:	V rms	Not Applicable
Insulation Resistance:	megohms minimum @VDC	1000 @ 500
TEMPERATURE		
Operating, AC Lower:	°C	Not Applicable
Operating, AC Upper:	°C	Not Applicable
Operating, DC Lower:	°C	-40
Operating, DC Upper:	°C	+80
Storage, Lower:	°C	-40
Storage, Upper:	°C	+130
LIFE EXPECTANCY		
Electrical @ Rated Load (AC1):	operations	200,000
Mechanical @ no Load :	operations	5,000,000
MISCELLANEOUS		
Operating Position:		Any
Insulation Material:	94V-0	Molded plastic
Enclosure Material:	94V-0	polycarbonate
Cover Protection Category:	IP	40
Terminals:	Inch (mm)	0.250 x 0.032 (6.35 x 0.81)
Weight:	grams	205

EXCEEDS NEMA STD. TS 2-1992 APPROVED BY D.O.T FOR:
California Minnesota Georgia New York Illinois Texas
Oregon Colorado Maryland Missouri North Carolina

OUTLINE DIMENSIONS

DIMENSIONS SHOWN IN INCHES & (MILLIMETERS).

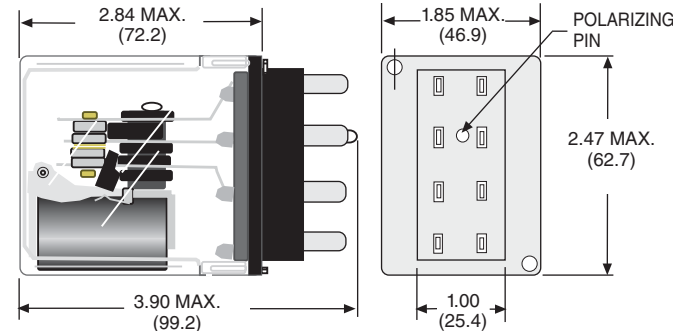

Mating Sockets
70-TRF8-1, 70-TRB8-1 : **SOLDER**
See section 7

STANDARD PART NUMBER	CONTACT CONFIGURATION	COIL MEASURED @ 25 °C	
		NOMINAL INPUT VOLTAGE	NOMINAL POWER
AC RECTIFIED - PLUG-IN, 30 AMP			
W21ACPX-2	DPDT	110/120 VAC, 50/60Hz	4.0 VA
136-627200	DPDT	110/120 VAC, 50/60Hz	10 VA

UL CONTACT LOAD RATINGS TABLE



CONTACT CONFIGURATION	CURRENT OR HORSE POWER	LOAD VOLTAGE	LOAD VOLTAGE FREQUENCY	TYPE OF LOAD
1 POLE THRU 6 POLES	5 AMP	120 VAC	50/60 Hz	RESISTIVE
	5 AMP	28 VDC	DC	RESISTIVE
	3 AMP	120 VAC	50/60 Hz	RESISTIVE
	3 AMP	28 VDC	DC	RESISTIVE



BIFURCATED CONTACTS (LOW LEVEL APPLICATIONS)

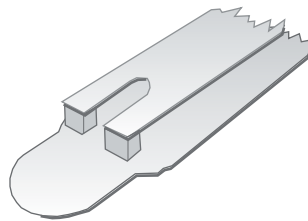

STANDARD CONTACTS (5 AMP CROSS BAR)

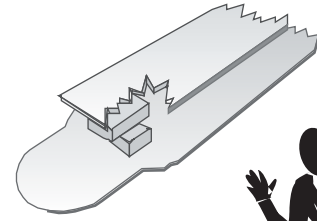

STANDARD CLASS 67 MINIATURE INDUSTRIAL RELAYS ARE DESIGNED FOR APPLICATIONS REQUIRING DPDT TO 6PDT CONTACTS WHERE SPACE AND WEIGHT ARE OF PRIME IMPORTANCE. SHATTER RESISTANT, SEE-THRU PLASTIC COVERS ARE UTILIZED TO PROTECT AGAINST DUST, TAMPERING AND ELECTRICAL SHOCK. THE 67T MODELS HAVE BIFURCATED CONTACTS AND ARE DESIGNED FOR LOW LEVEL SWITCHING APPLICATIONS.

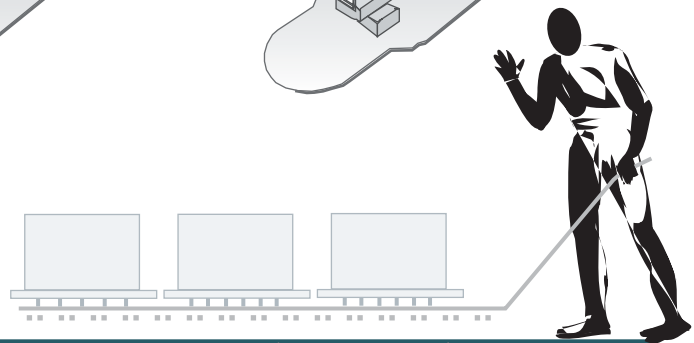

GENERAL SPECIFICATIONS (@ 25°C)

	UNITS	
COIL		
Pull-in Voltage AC (50/60 Hz):	% of nominal	80
Pull-in Voltage DC:	% of nominal	75
Dropout Voltage AC (50/60 Hz):	% of nominal	10
Dropout Voltage DC:	% of nominal	10
Maximum Voltage:	% of nominal	120
Resistance:	% ±	10
Coil Power AC (60 Hz):	VA	2.75
Coil Power DC:	W	0.45
Insulation System Per UL Standard 1446:		Class B (130 °C)
Duty:		Continuous
CONTACTS		
Contact Material:		Silver alloy
Contact Rating AC Amperes (AC1):		5/3
Contact Rating AC Voltage:	A	120 / 120
Contact Rating DC Amperes (DC1):	V	5/3
Contact Rating DC Voltage:	A	28 / 28
Minimum Recommended Load:	V	100 @ 5 VDC or 0.5 W
TIMING		
Operate Time:	ms	25
Release Time:	ms	20

	UNITS	
DIELECTRIC STRENGTH		
Coil to Contacts:	V rms	1500
Across Open Contacts:	V rms	1000
Pole to Pole:	V rms	1000
Contacts to Frame:	V rms	1000
Insulation Resistance:	megohms minimum @VDC	1000 @ 500
VIBRATION RESISTANCE		
Functional:	g's	10
SHOCK RESISTANCE		
Functional:	g's	20
TEMPERATURE		
Operating, AC Lower:	°C	-40
Operating, AC Upper:	°C	+60
Operating, DC Lower:	°C	-40
Operating, DC Upper:	°C	+60
Storage, Lower:	°C	-40
Storage, Upper:	°C	+130
LIFE EXPECTANCY		
Electrical @ Rated Load (AC1):	operations	100,000
Mechanical @ no Load :	operations	10,000,000
MISCELLANEOUS		
Operating Position:		Any
Insulation Material:	94V-0	Molded plastic
Enclosure Material:	94V-0	Polycarbonate
Cover Protection Category:	IP	40
Terminals:	Inch (mm)	0.10, 0.04 x 0.01 (2.54, 1.01 x 0.25)
Weight:	grams	22 to 40

67 MINIATURE ENCLOSED INDUSTRIAL RELAY



DPDT THRU 6PDT 3 & 5 AMPS

WIRING DIAGRAM

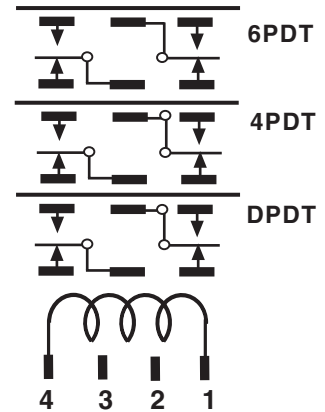

Mating Sockets

70-303-1, 70-305-1, 70-307-1: **SOLDER**
70-304-1, 70-306-1, 70-308-1: **PRINTED CIRCUIT**
See section 7

OUTLINE DIMENSIONS
DIMENSIONS SHOWN IN INCHES & (MILLIMETERS).

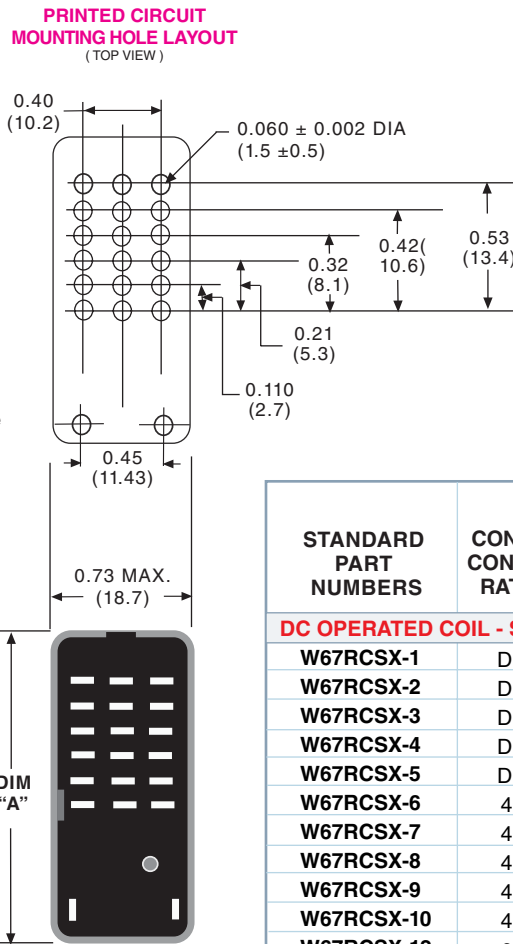
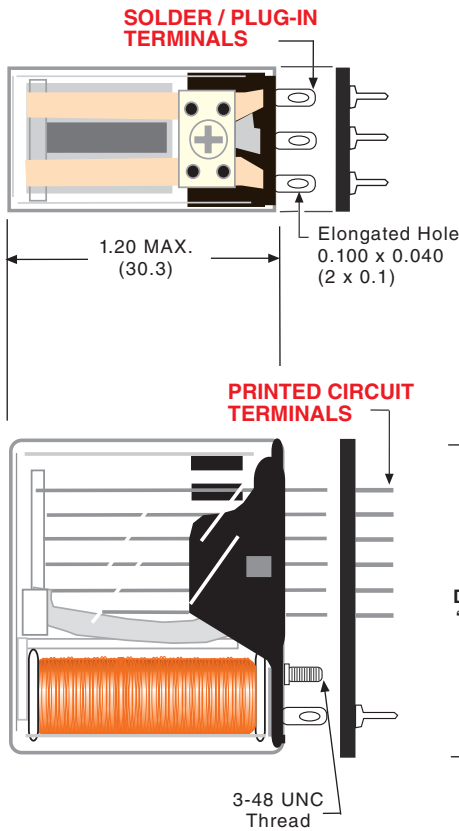

DIMENSIONS



CONTACT CONFIGU	"A"
6PDT	1.374 (34.9)
4PDT	1.156 (29.4)
DPDT	0.978 (24.8)

STANDARD PART NUMBERS	CONTACT CONFIGURATION	COIL MEASURED @ 25 °C	
		NOMINAL INPUT VOLTAGE	NOMINAL RESISTANCE (OHMS)
DC OPERATED COIL - SOLDER/PLUG-IN, 5 AMP			
W67RCSX-1	DPDT	5 VDC	52 Ω
W67RCSX-2	DPDT	12 VDC	185 Ω
W67RCSX-3	DPDT	24 VDC	700 Ω
W67RCSX-4	DPDT	48 VDC	2,500 Ω
W67RCSX-5	DPDT	110/125 VDC	15,000 Ω
W67RCSX-6	4PDT	5 VDC	52 Ω
W67RCSX-7	4PDT	12 VDC	185 Ω
W67RCSX-8	4PDT	24 VDC	700 Ω
W67RCSX-9	4PDT	48 VDC	2,500 Ω
W67RCSX-10	4PDT	110/125 VDC	15,000 Ω
W67RCSX-12	6PDT	12 VDC	90 Ω
W67RCSX-13	6PDT	24 VDC	430 Ω
DC OPERATED COIL-BIFURCATED CONTACTS, 3 AMP			
W67TRCSX-2	DPDT	12 VDC	185 Ω
W67TRCSX-3	DPDT	24 VDC	700 Ω
W67TRCSX-7	4PDT	12 VDC	185 Ω
W67TRCSX-8	4PDT	24 VDC	700 Ω
W67TRCSX-12	6PDT	12 VDC	90 Ω
W67TRCSX-13	6PDT	24 VDC	430 Ω
DC OPERATED PRINTED CIRCUIT, 5 AMP			
W67RPCX-2	DPDT	12 VDC	185 Ω
W67RPCX-3	DPDT	24 VDC	700 Ω
W67RPCX-7	4PDT	12 VDC	185 Ω
W67RPCX-8	4PDT	24 VDC	700 Ω
W67RPCX-12	6PDT	12 VDC	90 Ω
W67RPCX-13	6PDT	24 VDC	430 Ω
AC OPERATED COIL - SOLDER/PLUG-IN, 5 AMP			
W67ARCSX-5	DPDT	110/120 VAC, 50/60Hz	9000 Ω
W67ARCSX-10	4PDT	110/120 VAC, 50/60Hz	8000 Ω
W67ARCSX-15	6PDT	110/120 VAC, 50/60Hz	8000 Ω
DC OPERATED COIL ULTRA SENSITIVE -SOLDER/PLUG-IN, 3 AMP			
W67SCSX-1	DPDT	9.4 MADC	1,000 Ω
W67SCSX-2	DPDT	6.4 MADC	2,500 Ω
W67SCSX-3	DPDT	4.5 MADC	5,000 Ω
W67SCSX-6	4PDT	13.7 MADC	1,000 Ω
W67SCSX-7	4PDT	9.1 MADC	2,500 Ω
W67SCSX-8	4PDT	6.5 MADC	5,000 Ω

RETROFITS POTTER & BRUMFIELD R10.
SEE END OF SECTION 1 FOR CROSS REFERENCE

UL CONTACT LOAD RATINGS TABLE

CONTACT CONFIGURATION	CURRENT	LOAD VOLTAGE	LOAD VOLTAGE FREQUENCY	TYPE OF LOAD
ALL STYLES	10 AMP	120 VAC	50/60 Hz	RESISTIVE
	5 AMP	240 VAC	50/60 Hz	RESISTIVE
	10 AMP	28 VDC	DC	RESISTIVE
	0.5 AMP	125 VDC	DC	RESISTIVE
	3 AMP	120 VAC	50/60 Hz	INDUCTIVE
	1 AMP	240 VAC	50/60 Hz	INDUCTIVE
	3 AMP	28 VDC	DC	INDUCTIVE
SUFFIX "69" WITH BLOWOUT MAGNET FOR DC SWITCHING (NOT UL OR CSA)				
SINGLE MAKE AND DOUBLE MAKE	1.5 AMP	125 VDC	DC	RESISTIVE
	4 AMP	125 VDC	DC	RESISTIVE
	0.5 AMP	250 VDC	DC	RESISTIVE
	1.5 AMP	250 VDC	DC	RESISTIVE
	0.5 AMP	125 VDC	DC	INDUCTIVE
	1.5 AMP	125 VDC	DC	INDUCTIVE
	150 mA	250 VDC	DC	INDUCTIVE
	0.5 AMP	250 VDC	DC	INDUCTIVE

CONTACTS CAN CLOSE ON 30 AMP LOADS AND CARRY 10 AMPS CONTINUOUSLY AT ALL VOLTAGES SHOWN

US
UL Recognized
File No. E13224

168986

US
LISTED 225G
IND. CONT. EQ.

WHEN USED WITH
SOCKETS 27390D
OR 33377D

CURRENT LIMITED
TO RATING OF
RELAY OR SOCKET
WHICHEVER IS LESS

COIL SPECIFICATIONS @ 25°C

AC RELAYS, 50/60 HZ 5 VA (COIL DATA @ 60HZ)					DC RELAYS, 1.8 WATTS (2.5 W @ 125 VDC)			
Nominal Voltage	Resistance Ohms ±10%	Milliamperes		Impedance Ohms	Nominal Voltage	Resistance Ohms ±10%	Milliamperes	
		Inrush (Open)	Sealed (Pull-In)				Cold	Hot
6	1.1	1500	840	7.2	6	15.5	385	304
12	4.2	750	410	27	12	63.5	189	147
24	15.5	375	200	120	24 / 28*	250	96	77
120	540	75	40	2700	32	375	86	62
240	2100	32	17	13,400	115/125*	6200	20	16



OUTLINE DIMENSIONS

DIMENSIONS SHOWN IN INCHES & (MILLIMETERS).

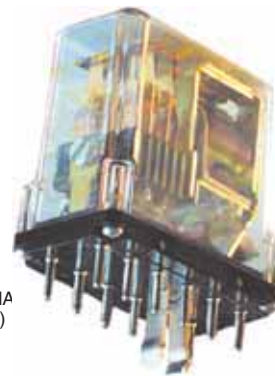
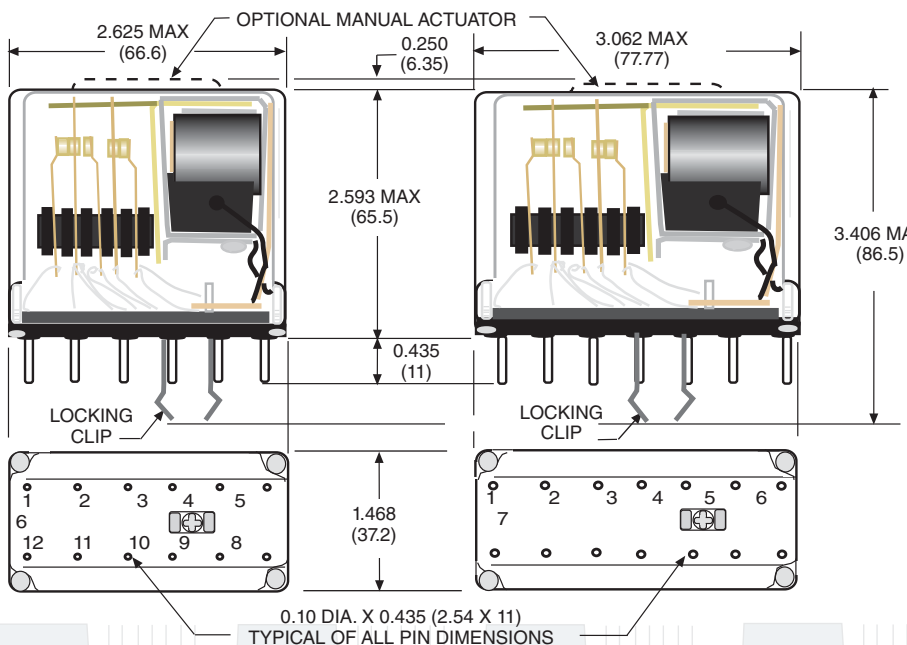

* 24 VDC & 110 VDC Relays Have Name Plates Stamped 24-28 & 110-125 VDC Respectively. These Relays Operate At 80% Of The Lower Voltages And Operate Within Allowable Temperature Rises At 110% Of Higher Voltages. 250 VDC: Use 125 VDC Relay And Series Resistor (6000 Ω, 5 W) Not Supplied.

THE 219 COIL IS ENCAPSULATED IN THERMO-SET EPOXY FOR PROTECTION. THE BUILT-IN LOCKING CLIP ELIMINATES THE NEED FOR ANY EXTERNAL HOLD-DOWN DEVICE. NUCLEAR QUALIFIED VERSIONS ARE AVAILABLE. PLEASE CONSULT FACTORY.

219 PLUG-IN RELAY WITH INTEGRAL LOCKING CLIP



12 & 14 PIN, 10 AMPS

WIRING DIAGRAM (TOP VIEW)



Mating Sockets
27390D, 33377D:
SCREW/PANEL/DIN
See section 7

GENERAL SPECIFICATIONS (@ 25°C)

	UNITS	
COIL		
Pull-in Voltage AC (50/60 Hz):≤	% of nominal	85
Pull-in Voltage DC:≤	% of nominal	80
Dropout Voltage AC (50/60 Hz):≥	% of nominal	10
Dropout Voltage DC:≥	% of nominal	10
Maximum Voltage:	% of nominal	110
Resistance:	% ±	10
Insulation System Per UL Standard 1446: Duty:		Class B (130°C) Continuous
CONTACTS		
Contact Configuration:		to 6PDT
Contact Material:		Silver alloy, gold diffused
Contact Rating AC Amperes (AC1):	A	10/5
Contact Rating AC Voltage:	V	120 / 120
Contact Rating DC Amperes (DC1):	A	10/5
Contact Rating DC Voltage:	V	28 / 28
Minimum Recommended Load:	ma	100 @ 5 VDC or 0.5 W
TIMING		
Operate Time:	ms	25
Release Time:	ms	20
DIELECTRIC STRENGTH		
Coil to Contacts:	V rms	1500
Across Open Contacts:	V rms	1500
Pole to Pole:	V rms	1500
Contacts to Frame:	V rms	1500
Insulation Resistance:	megohms minimum @VDC	1000 @ 500
VIBRATION RESISTANCE		
Functional:	g's	10
SHOCK RESISTANCE		
Functional:	g's	20
TEMPERATURE		
Operating, AC Lower:	°C	-40
Operating, AC Upper:	°C	+80
Operating, DC Lower:	°C	-40
Operating, DC Upper:	°C	+80
Storage, Lower:	°C	-40
Storage, Upper:	°C	+130
LIFE EXPECTANCY		
Electrical @ Rated Load (AC1):	operations	100,000
Mechanical @ no Load :	operations	10,000,000
MISCELLANEOUS		
Operating Position:		Any
Insulation Material:	94V-0	Molded plastic
Enclosure Material:	94V-0	polycarbonate
Cover Protection Category:	IP	40
Weight:	grams	241

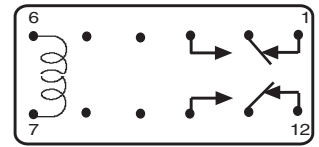

**219XBP
DPDT**

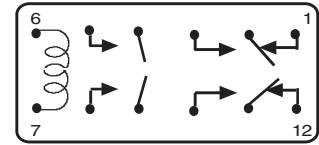

**219BBXP
DPDT+2 NO**

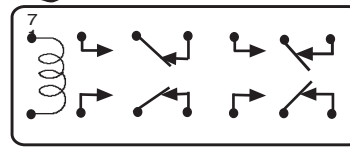

**219DXBP
4PDT**

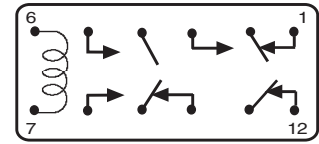

**219ABAP
DPDT+1NO & 1NC**

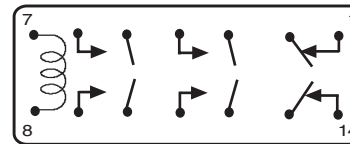

**219DXBP
4P-NO+2P-NC**

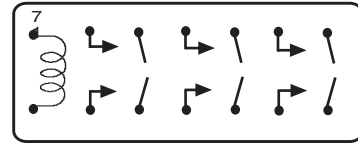

**219FXXP
6P-NO**

ORDERING CODE

219 **XBX** **P** **L** **-24D**

CLASS: _____

CONTACT CONFIGURATION:

- DPDT: **XBX**
- DPDT +1 POLE: NO & 1 POLE NC: **ABA**
- 2 POLE: NO & DPDT: **BBX**
- 4 PDT: **DXD**
- 6 POLE: NO: **FXX**
- 4 POLE: NO & 2 POLE: NC: **DXB**

OPTIONAL MAGNETIC BLOWOUT: _____

CODE 69

OPTIONAL BIFURCATED CONTACTS: _____

CODE 33

STANDARD FEATURES: _____

POLYCARBONATE COVER: CODE P

OPTIONAL FEATURES: _____

STATUS LAMP: CODE L

MANUAL ACTUATOR: CODE M

COIL VOLTAGE: _____

6, 12, 24, 120, 240 **ADD "A" FOR AC COILS**

6, 12, 24, 48, 110 /125 **ADD "D" FOR DC COILS**

COIL VOLTAGES & FREQUENCIES MUST BE SPECIFIED.

Make before break and other contact configurations available,

UL
UL Recognized
File No. E43641

UL
LISTED 367G
IND. CONT. EQ.
WHEN USED WITH
SOCKETS:
70-464-1, 70-465-1,
70-750D8-1 & 70-750D11-1

CURRENT LIMITED
TO RATING OF
RELAY OR SOCKET
WHICHEVER IS LESS

FEATURES

VACUUM BAKED & DRY
NITROGEN FILLED

HERMETICALLY
SEALED METAL
ENCLOSURE

PLUG-IN STYLE
MOUNTING

BENEFITS

REMOVES CONTAMINANTS AND PROVIDES
A CLEAN & DRY ATMOSPHERE FOR CONTACTS.

IDEAL FOR USE IN HAZARDOUS LOCATIONS.
UL CERTIFIED FOR CLASS 1 DIVISION 2 GROUP
A, B, C & D HAZARDS.

WHEN USED WITH 70-464-1, 70-465-1, 70-750D8-1 OR
70-750D11-1 SOCKETS,
THE 750H CAN BE DIN RAIL MOUNTED OR PANEL MOUNTED.



**CERTIFIED CLASS 1
DIVISION 2 FOR
HAZARDOUS LOCATIONS
UL GROUPS A, B, C & D**

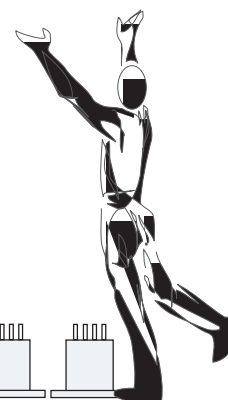

GENERAL SPECIFICATIONS (@ 25°C)

	UNITS	
COIL		
Pull-in Voltage AC (50/60 Hz):≤	% of nominal	85
Pull-in Voltage DC:≤	% of nominal	80
Dropout Voltage AC (50/60 Hz):≥	% of nominal	10
Dropout Voltage DC:≥	% of nominal	10
Maximum Voltage:	% of nominal	110
Resistance:	% ±	10
Coil Power AC (60 Hz):	VA	2.0
Coil Power DC:	W	1.2
Insulation System Per UL Standard 1446: Duty:		Class B (130 °C) Continuous
CONTACTS		
Contact Material:		Silver alloy gold flashed
Contact Rating AC Amperes (AC1):	A	2 Pole-12, 3 Pole-10
Contact Rating AC Voltage:	V	120 / 240
Contact Rating DC Amperes (DC1):	A	10
Contact Rating DC Voltage:	V	30
Horse Power (AC):	HP	1/2 @ 120
Horse Power (AC):	HP	1/3 @ 240
Minimum Recommended Load:	ma	100 @ 5 VDC or 0.5 W
TIMING		
Operate Time:	ms	15
Release Time:	ms	10

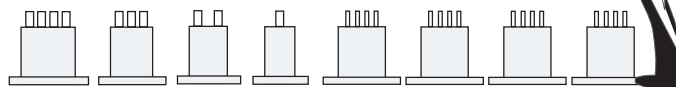

	UNITS	
DIELECTRIC STRENGTH		
Coil to Contacts:	V rms	1250
Across Open Contacts:	V rms	500
Pole to Pole:	V rms	1250
Contacts to Frame:	V rms	Not applicable
Insulation Resistance:	megohms minimum @VDC	1000 @ 500
TEMPERATURE		
Operating, AC Lower:	°C	-45
Operating, AC Upper:	°C	+55
Operating, DC Lower:	°C	-45
Operating, DC Upper:	°C	+70
Storage, Lower:	°C	-45
Storage, Upper:	°C	+105
LIFE EXPECTANCY		
Electrical @ Rated Load (AC1):	operations	100,000
Mechanical @ no Load :	operations	5,000,000
MISCELLANEOUS		
Operating Position:		Any
Insulation Material:	94V-0	Molded plastic
Enclosure Material:		Steel
Cover Protection Category:	IP	67
Weight:	grams	130

750H OCTAL STYLE HERMETICALLY SEALED RELAY



**DPDT, 12 AMPS
3PDT, 10 AMPS**

WIRING DIAGRAM
(VIEWED FROM PIN END)

OUTLINE DIMENSIONS
DIMENSIONS SHOWN IN INCHES & (MILLIMETERS).

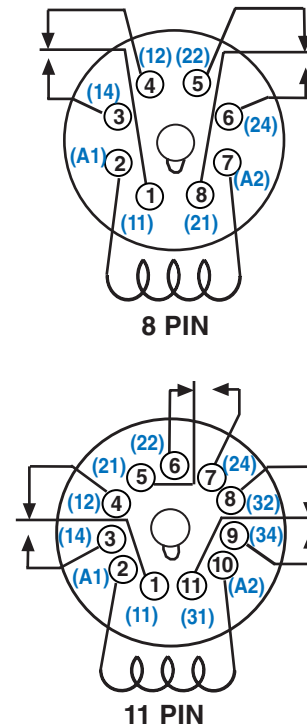
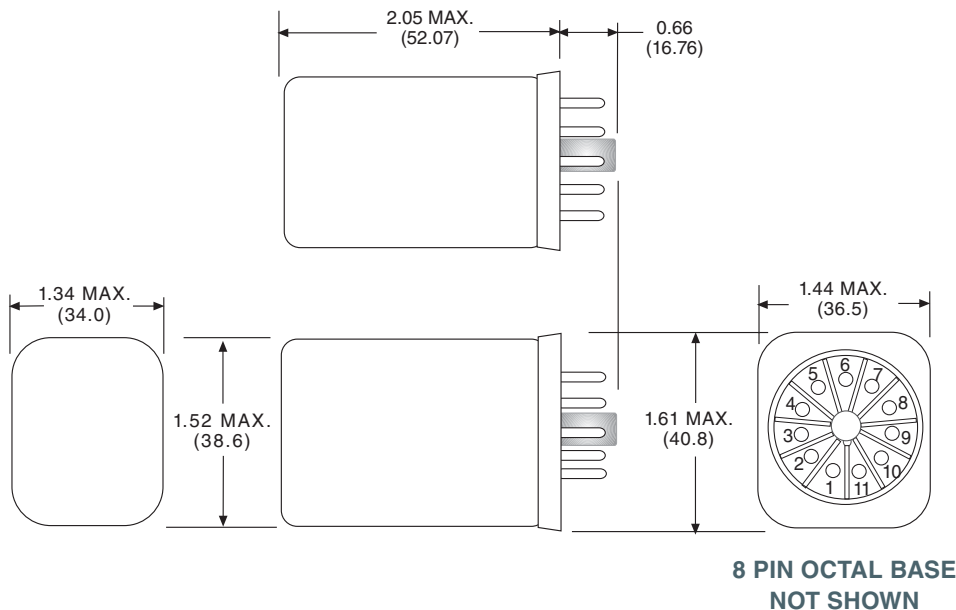

ALTERNATE NEMA
OR IEC () NUMBERS
VIEWED FROM
PIN SIDE



Mating Sockets
70-750D8-1, 70-750D11-1,
70-464-1, 70-465-1: SCREW/DIN
70-169-1, 70-170-1: SCREW/PANEL
See Section 7



STANDARD PART NUMBERS		CONTACT CONFIGURATION	COIL MEASURED @ 25 °C	
			NOMINAL INPUT VOLTAGE	NOMINAL RESISTANCE (OHMS)
NEW PART NUMBER	SUPERCEDES			
AC OPERATED - 8 PIN OCTAL, 12 AMP				
750XBXH-12A		DPDT	12 VAC, 50/60Hz	72 Ω
750XBXH-24A		DPDT	24 VAC, 50/60Hz	1,700 Ω
750XBXH-120A	W88AHPX-24	DPDT	110/120 VAC, 50/60Hz	9,100 Ω
DC OPERATED - 8 PIN OCTAL, 12 AMP				
750XBXH-12D	W88HPX-33	DPDT	12 VDC	120 Ω
750XBXH-24D	W88HPX-34	DPDT	24 VDC	470 Ω
750XBXH-110/125D		DPDT	110/125 VDC	10,000 Ω
AC OPERATED - 11 PIN OCTAL, 10 AMP				
750XCXH-12A		3PDT	12 VAC, 50/60Hz	72 Ω
750XCXH-24A		3PDT	24 VAC, 50/60Hz	1,700 Ω
750XCXH-120A	*W88AHPX-36	3PDT	110/120 VAC, 50/60Hz	9,100 Ω
DC OPERATED - 11 PIN OCTAL, 10 AMP				
750XCXH-12D		3PDT	12 VDC	120 Ω
750XCXH-24D	*W88HPX-51	3PDT	24 VDC	470 Ω
750XCXH-110/125D		3PDT	110/125 VDC	10,000 Ω

* SOCKET CONNECTIONS TO TERMINALS 5 & 6 (21 & 22) MUST BE REVERSED

SECTION 1

CROSS REFERENCE GUIDE



MAGNECRAFT & STRUTHERS-DUNN	IDEC		
781XAXM4L-24A	RH1B-L-AC24		
781XAXM4L120A	RH1B-L-AC120		
781XAXM4L-220/230A	RH1B-L-AC240		
781XAXM4L-240A	RH1B-L-AC240		
781XAXM4L-12D	RH1B-L-DC12		
781XAXM4L-24D	RH1B-L-DC24		
781XAXM4L-110D	RH1B-L-DC110		
781XAXTM4L-120A	RH1V2-L-AC120		
781XAXTM4L-12D	RH1V2-L-DC12		
781XAXTM4L-24D	RH1V2-L-DC24		
781XAXC-24A	RH1B-U-AC24		
781XAXC-120A	RH1B-U-AC120		
781XAXC-24D	RH1B-U-DC24		
MAGNECRAFT & STRUTHERS-DUNN	OMRON	RELECO	
782XAXM4L-12A		C7-A10X/AC12	
782XAXM4L-24A		C7-A10X/AC24	
782XAXM4L120A		C7-A10X/AC115	
782XAXM4L-220/230A		C7-A10X/AC230	
782XAXM4L-240A			
782XAXM4L-12D		C7-A10X/DC12	
782XAXM4L-24D		C7-A10X/DC24	
782XAXM4L-110D		C7-A10X/DC110	
782XAXTM4L-12A		C7-A10PX/AC12	
782XAXTM4L-24A		C7-A10PX/AC24	
782XAXTM4L120A		C7-A10PX/AC115	
782XAXTM4L-12D		C7-A10PX/DC12	
782XAXTM4L-24D		C7-A10PX/DC24	
782XAXTM4L-110D		C7-A10PX/DC110	
782XAXC-12A	LY1-AC12		
782XAXC-24A	LY1-AC24		
782XAXC120A	LY1-AC110/120		
782XAXC-220/230A	LY1-AC220/240		
782XAXC-240A	LY1-AC220/240		
782XAXCL-24A	LY1N-AC24		
782XAXCL120A	LY1N-AC110/120		
782XAXCL-240A	LY1N-AC220/240		
782XAXC-12D	LY1-DC12		
782XAXC-24D	LY1-DC24		
782XAXC-110D	LY1-DC110		
782XAXTCL-24D	LY1N-DC24		
782XAXTC-12A	LY1-0-AC12		
782XAXTC-24A	LY1-0-AC24		
782XAXTC-120A	LY1-0-AC110/120		
782XAXTC-12D	LY1-0-DC12		
782XAXTC-24D	LY1-0-DC24		
782XAXTC-110D	LY1-0-DC110		

THE CROSS REFERENCE IS INTENDED TO MATCH FOOT PRINT, INTERNAL WIRING, AND CONTACT LOAD RATINGS. CONSTRUCTION FEATURES AND GENERAL SPECIFICATIONS SHOULD BE COMPARED IF EXACT REPLACEMENT IS REQUIRED.

CROSS REFERENCE GUIDE

MAGNECRAFT & STRUTHERS-DUNN	OMRON	FINDER	RELECO	IDEC	RELPOL
782BXM4L-24A	LY212N-AC24	56.32.8024.20.94	C7-A20X/AC24		RY2-1012-26-5024-WTL
782BXM4L120A	LY212N-AC120	56.32.8120.20.94	C7-A20X/AC120		RY2-1012-26-5120-WTL
782BXM4L-220/230A		56.32.8230.20.94	C7-A20X/AC230		RY2-1012-26-5230-WTL
782BXM4L-240A		56.32.8240.20.94			RY2-1012-26-5240-WTL
782BXM4L-12D	LY212N-DC12	56.32.9012.20.94	C7-A20X/DC12		RY2-1012-26-1012-WTL
782BXM4L-24D	LY212N-DC24	56.32.9024.20.94	C7-A20X/DC24		RY2-1012-26-1024-WTL
782BXM4L-110D		56.32.9110.20.94	C7-A20X/DC110		RY2-1012-26-1110-WTL
782XBXC-6A	LY2-AC06			RH2B-U-AC6	RY2-1006-26-5006
782XBXC-24A	LY2-AC24			RH2B-U-AC24	RY2-1012-26-5024
782XBXC120A	LY2-AC110/120			RH2B-U-AC120	RY2-1012-26-5120
782XBXC220/230A	LY2-AC220/240			RH2B-U-AC240	RY2-1012-26-5230
782XBXC240A	LY2-AC220/240			RH2B-U-AC240	RY2-1012-26-5240
782XBXC-6D	LY2-DC06			RH2B-U-DC6	RY2-1012-26-5006
782XBXC-12D	LY2-DC12			RH2B-U-DC12	RY2-1012-26-1012
782XBXC-24D	LY2-DC24			RH2B-U-DC24	RY2-1012-26-1024
782XBXC48D	LY2-DC48			RH2B-U-DC48	RY2-1012-26-1048
782XBXC-110D	LY2-DC110			RH2B-U-DC110	RY2-1012-26-1110
782XBXTC-24A	LY2-0-AC24		C7-A20X/AC24	RH2V2-AC24	
782XBXTC120A	LY2-0-AC120		C7-A20X/AC115	RH2V2-AC120	
782XBXTC-6D	LY2-0-DC06			RH2V2-DC6	
782XBXTC-12D	LY2-0-DC12		C7-A20X/DC12	RH2V2-DC12	
782XBXTC-24D	LY2-0-DC24		C7-A20X/DC24	RH2V2-DC24	
MAGNECRAFT & STRUTHERS-DUNN	OMRON	FINDER	RELECO	IDEC	
783CXM4L-24A				RH3B-ULC-AC24	
783CXM4L-120A				RH3B-ULC-AC120	
783CXM4L-220/230A					
783CXM4L-240A				RH3B-ULC-AC240	
783CXM4L-12D				RH3B-ULC-DC12	
783CXM4L-24D				RH3B-ULC-DC24	
783CXM4L-110D				RH3B-ULC-DC110	
783XCXTM4L-120A				RH3V2-ULC-AC120	
783XCXTM4L-12D				RH3V2-ULC-DC12	
783XCXTM4L-24D				RH3V2-ULC-DC24	
783XCXC-24A	LY3-AC24			RH3B-U-AC24	
783XCXC-120A	LY3-AC120			RH3B-U-AC120	
783XCXC-240A	LY3-AC240			RH3B-U-DC24	
MAGNECRAFT & STRUTHERS-DUNN	OMRON	FINDER	RELECO	IDEC	
784DXM4L-24A	LY412N-AC24	56.34.8024.20.94		RH4B-ULC-AC24	
784DXM4L-120A	LY412N-AC120	56.34.8120.20.94		RH4B-ULC-AC120	
784DXM4L-220/230A		56.34.8230.20.94			
784DXM4L-240A		56.34.8240.20.94		RH4B-ULC-AC240	
784DXM4L-12D	LY412N-DC12	56.34.9012.20.94		RH4B-ULC-DC12	
784DXM4L-24D	LY412N-DC24	56.34.9024.20.94		RH4B-ULC-DC24	
784DXM4L-110D		56.34.9110.20.94		RH4B-ULC-DC110	
784DXTM4L-120A		56.44.8120.20.94		RH4V2-ULC-AC120	

THE CROSS REFERENCE IS INTENDED TO MATCH FOOT PRINT, INTERNAL WIRING, AND CONTACT LOAD RATINGS. CONSTRUCTION FEATURES AND GENERAL SPECIFICATIONS SHOULD BE COMPARED IF EXACT REPLACEMENT IS REQUIRED.

SECTION 1

CROSS REFERENCE GUIDE



MAGNECRAFT & STRUTHERS-DUNN	OMRON	FINDER	RELECO	IDEC	
784XDXTM4L-12D		56.44.9012.20.94		RH4V2-ULC-DC12	
784XDXTM4L-24D		56.44.9024.20.94		RH4V2-ULC-DC24	
784XDXC-24A	LY4-AC24	56.34.8024.20.94		RH4B-U-AC24	
784XDXC-120A	LY4-AC120	56.34.8120.20.94		RH4B-U-AC120	
784XDXC-24D	LY4-DC24	56.34.8240.20.94		RH4B-U-DC24	
MAGNECRAFT & STRUTHERS-DUNN	OMRON	FINDER	RELECO	TYCO / SCHRACK	RELPOL
782XDX3M4L-24A			C9-T48X/AC24		
782XDX3M4L120A			C9-T48X/AC115		
782XDX3M4L-220/230A			C9-T48X/AC230		
782XDX3M4L-240A					
782XDX3M4L-12D			C9-T48X/DC12		
782XDX3M4L-24D			C9-T48X/DC24		
782XDX3M4L-110D			C9-T48X/DC110		
782XDX1M4L-24A			C9-A48X/AC24		
782XDX1M4L120A			C9-A48X/AC115		
782XDX1M4L-220/230A			C9-A48X/AC230		
782XDX1M4L-240A					
782XDX1M4L-12D			C9-A48X/DC12		
782XDX1M4L-24D			C9-A48X/DC24		
782XDX1M4L-110D			C9-A48X/DC110		
782XDX2M4L-24A		55.34.8024.20.94	C9-T48X/AC24	PT570524	R4-2014-23-5024-WTL
782XDX2M4L120A		55.34.8120.20.94	C9-T48X/AC115	PT570615	R4-2014-23-5012-WTL
782XDX2M4L-220/230A		55.34.8230.20.94	C9-T48X/AC230	PT570730	R4-2014-23-5030-WTL
782XDX2M4L-240A		55.34.8240.20.94		PT570730	R4-2014-23-5040-WTL
782XDX2M4L-12D		55.34.9012.20.94	C9-T48X/DC12	PT570012	R4-2014-23-1012-WTL
782XDX2M4L-24D		55.34.9024.20.94	C9-T48X/DC24	PT570024	R4-2014-23-1024-WTL
782XDX2M4L-110D		55.34.9110.20.94	C9-T48X/DC110	PT570110	R4-2014-23-1110-WTL
782XDX3C-12A	MY4Z-AC-12				
782XDX3C-24	MY4Z-AC-24				
782XDX3C-120A	MY4Z-AC-120				
782XDX3C-220/230A	MY4Z-AC-220/230				
782XDX3C-240A	MY4Z-AC-240				
782XDX3C-6D	MY4Z-DC-6				
782XDX3C-12D	MY4Z-DC-12				
782XDX3C-24D	MY4Z-DC-24				
782XDX3C-110D	MY4Z-DC-110				
782XDX1C-12A	MY4-AC-12				
782XDX1C-24	MY4-AC-24				
782XDX1C-120A	MY4-AC-120				
782XDX1C-220/230A	MY4-AC-220/230				
782XDX1C-240A	MY4-AC-240				
782XDX1C-6D	MY4-DC-6				
782XDX1C-12D	MY4-DC-12				
782XDX1C-24D	MY4-DC-24				
782XDX1C-110D	MY4-DC-110				
782XDX2C-12A	MY4-AC-12				R4-2014-23-5012
782XDX2C-120A	MY4-AC-120				R4-2014-23-5120

THE CROSS REFERENCE IS INTENDED TO MATCH FOOT PRINT, INTERNAL WIRING, AND CONTACT LOAD RATINGS. CONSTRUCTION FEATURES AND GENERAL SPECIFICATIONS SHOULD BE COMPARED IF EXACT REPLACEMENT IS REQUIRED.

CROSS REFERENCE GUIDE

MAGNECRAFT & STRUTHERS-DUNN	OMRON	FINDER	RELECO	TYCO / SCHRACK	RELPOL	ALLEN-BRADLEY
782XDX2C-220/230A	MY4-AC220/240				R4-2014-23-5012	
782XDX2C-240A	MY4-AC240				R4-2014-23-5120	
782XDX2C-12D	MY4-DC12				R4-2014-23-5230	
782XDX2C-24D	MY4-DC24				R4-2014-23-5240	
782XDX2C-110D	MY4-DC110				R4-2014-23-1012	
782XDXT1C-24A	MY4-02-AC24				R4-2014-23-1024	
782XDXT1C-120A	MY4-02-AC120				R4-2014-23-1110	
782XDXT1C-12D	MY4-02-DC12					
782XDXT1C-24D	MY4-02-DC24					
782XDXT1C-110D	MY4-02-DC110					
782XBX3M4L-24A			C9-T28X/AC24			
782XBX3M4L-120A			C9-T28X/AC115			
782XBX3M4L-220/230A			C9-T28X/AC230			
782XBX3M4L-240A						
782XBX3M4L-12D			C9-T28X/DC12			
782XBX3M4L-24D			C9-T28X/DC24			
782XBX3M4L-110D			C9-T28X/DC110			
782XBX2M4L-24A		55.32.8024.20.94	C9-A20X/AC24	PT270524	R2-2012-23-5024-WTL	700-HC24A24-1-4
782XBX2M4L-120A		55.32.8120.20.94	C9-A20X/AC115	PT270615	R2-2012-23-5120-WTL	700-HC24A1-1-4
782XBX2M4L-220/230A		55.32.8230.20.94	C9-A20X/AC230	PT270730	R2-2012-23-5230-WTL	700-HC24A2-1-4
782XBX2M4L-240A		55.32.8240.20.94		PT270730	R2-2014-23-5240-WTL	700-HC24A2-1-4
782XBX2M4L-12D		55.32.9012.20.94	C9-A20X/DC12	PT270012	R2-2012-23-1012-WTL	700-HC24Z12-1-4
782XBX2M4L-24D		55.32.9024.20.94	C9-A20X/DC24	PT270024	R2-2012-23-1024-WTL	700-HC24Z24-1-4
782XBX2M4L-110D		55.32.9110.20.94	C9-A20X/DC110	PT270110	R2-2012-23-1110-WTL	700-HC24Z1-1-4
MAGNECRAFT & STRUTHERS-DUNN	TYCO / SCHRACK HERMETICALLY SEALED					
782DXH10-24A		KHS17A11-24				
782DXH10-120A		KHS17A11-120				
782DXH10-12D		KHS17D11-12				
782DXH10-24D		KHS17D11-24				
782DXH10-110D		KHS17D11-110				
782DXH21-120A		KHS17A12-120				
782DXH21-12D		KHS17D12-12				
782DXH21-24A		KHS17A12-24				
MAGNECRAFT & STRUTHERS-DUNN	OMRON	FINDER	RELECO	TYCO / P & B / SCHRACK	RELPOL	ALLEN-BRADLEY
750XBXM4L-24A	MK2PN-S-AC24	60.12.8024.20.70	C2-A20X/AC24	KRPA-11ANFP-24 or MT228024	R15-2012-23-5024-WTL	700-HA32A24-1-4
750XBXM4L-120A	MK2PN-S-AC120	60.12.8120.20.70	C2-A20X/AC120	KRPA-11ANFP-120 or MT228115	R15-2012-23-5210-WTL	700-HA32AA1-1-4
750XBXM4L-220/240A	MK2PN-S-AC240	60.12.8204.20.70	C2-A20X/AC240	KRPA-11ANFP-240 or MT228240	R15-2012-23-5230-WTL	700-HA32A2-1-4
750XBXM4L-12D	MK2PN-S-DC12	60.12.9012.20.70	C2-A20X/DC12	KRPA-11DNFP-12 or MT223012	R15-2012-23-1012-WTL	700-HA32Z12-1-4
750XBXM4L-24D	MK2PN-S-DC24	60.12.9024.20.70	C2-A20X/DC24	KRPA-11DNFP-24 or MT223024	R15-2012-23-1024-WTL	700-HA32Z24-1-4
750XBXM4L-110D	MK2PN-S-DC110	60.12.9110.20.70	C2-A20X/DC110	KRPA-11DNFP-24 or MT223110	R15-2012-23-1110-WTL	700-HA32Z1-1-4
750XCXM4L-24A	MK3PN-S-AC24	60.13.8024.20.70	C3-A30X/AC24	KRPA-14DNFP-24 or MT328024	R15-2012-23-5024-WTL	700-HA33A24-1-4
750XCXM4L-120A	MK3PN-S-AC120	60.13.8120.20.70	C3-A30X/AC120	KRPA-14ANFP-120 or MT322115	R15-2012-23-5210-WTL	700-HA33AA1-1-4
750XCXM4L-220/240A	MK3PN-S-AC240	60.13.8204.20.70	C3-A30X/AC240	KRPA-14ANFP-240 or MT328240	R15-2012-23-5230-WTL	700-HA33A2-1-4
750XCXM4L-12D	MK3PN-S-DC12	60.13.9012.20.70	C3-A30X/DC12	KRPA-14DNFP-12 or MT323012	R15-2012-23-1012-WTL	700-HA33Z12-1-4
750XCXM4L-24D	MK3PN-S-DC24	60.13.9024.20.70	C3-A30X/DC24	KRPA-14DNFP-24 or MT323024	R15-2012-23-1024-WTL	700-HA33Z24-1-4
750XCXM4L-110D	MK3PN-S-DC110	60.13.9110.20.70	C3-A30X/DC110	KRPA-14DNFP-24 or MT323110	R15-2012-23-1110-WTL	

THE CROSS REFERENCE IS INTENDED TO MATCH FOOT PRINT, INTERNAL WIRING, AND CONTACT LOAD RATINGS. CONSTRUCTION FEATURES AND GENERAL SPECIFICATIONS SHOULD BE COMPARED IF EXACT REPLACEMENT IS REQUIRED.

MAGNECRAFT & STRUTHERS-DUNN	OMRON	TYCO / P & B / SCHRACK	IDEC			
750XBXC-24A	MK2P-S-AC24	KRPA-11AG-24	RH2P-U-AC24			
750XBXC-120A	MK2P-S-AC120	KRPA-11AG-120	RH2P-U-AC120			
750XBXC-220/240A	MK2P-S-AC240	KRPA-11AG-240				
750XBXC-12D	MK2P-S-DC12	KRPA-11DG-12	RH2P-U-DC12			
750XBXC-24D	MK2P-S-DC24	KRPA-11DG-24	RH2P-U-DC24			
750XBXC-110D	MK2P-S-DC110	KRPA-11DG-110	RH2P-U-DC110			
750XCXC-24A	MK3P5-S-AC24	KRPA-14AG-24	RH3P-U-AC24			
750XCXC-120A	MK3P5-S-AC120	KRPA-14AG-120	RH3P-U-AC120			
750XCXC-220/240A	MK3P5-S-AC240	KRPA-14AG-240	RH3P-U-AC240			
750XCXC-12D	MK3P5-S-DC12	KRPA-14DG-12	RH3P-U-DC12			
750XCXC-24D	MK3P5-S-DC24	KRPA-14DG-24	RH3P-U-DC24			
750XCXC-110D	MK3P5-S-DC110	KRPA-14DG-110	RH3P-U-DC110			
MAGNECRAFT & STRUTHERS-DUNN	FINDER	RELECO	TYCO / P & B / SCHRACK	IDEC	RELPOL	ALLEN-BRADLEY
788BXM4L-24A	62.32.8024.00.70	C5-A20X/AC24		RR2BA-U-AC24		700-HB32A24-1-4
788BXM4L-120A	62.32.8120.00.70	C5-A20X/AC120		RR2BA-U-AC120		700-HB32AA1-1-4
788BXM4L-220/240A	62.32.8204.00.70	C5-A20X/AC240		RR2BA-U-AC240		700-HB32A2-1-4
788BXM4L-12D	62.32.9012.00.70	C5-A20X/DC12		RR2BA-U-DC12		700-HB32Z12-1-4
788BXM4L-24D	62.32.9024.00.70	C5-A20X/DC24		RR2BA-U-DC24		700-HB32Z24-1-4
788BXM4L-110D	62.32.9110.00.70	C5-A20X/DC110		RR2BA-U-DC110		700-HB32Z1-1-4
788XCXM4L-24A	62.33.8024.00.70	C5-A30X/AC24		RR3BA-U-AC24		700-HB33A24-1-4
788XCXM4L-120A	62.33.8120.00.70	C5-A30X/AC120		RR3BA-U-AC120		700-HB33AA1-1-4
788XCXM4L-220/240A	62.33.8204.00.70	C5-A30X/AC240		RR3BA-U-AC240		700-HB33A2-1-4
788XCXM4L-12D	62.33.9012.00.70	C5-A30X/DC12		RR3BA-U-DC12		700-HB33Z12-1-4
788XCXM4L-24D	62.33.9024.00.70	C5-A30X/DC24		RR3BA-U-DC24		700-HB33Z24-1-4
788XCXM4L-110D	62.33.9110.00.70	C5-A30X/DC110		RR3BA-U-DC110		
788XBXC-24A			KUP-11A45 (or F) -24 or RM202524		RUC-1012-26-5024	
788XBXC-120A			KUP-11A45- (or F) 120 or RM202615		RUC-1012-26-5210	
788XBXC-220/240A			KUP-11A45- (or F) 240 or RM202730		RUC-1012-26-5230	
788XBXC-12D			KUP-11D45- (or F) 12 or RM202012		RUC-1012-26-1012	
788XBXC-24D			KUP-11D45- (or F) 24 or RM202024		RUC-1012-26-1024	
788XBXC-110D			KUP-11D45- (or F) 110 or RM202110		RUC-1012-26-1110	
788XCXC-24A			KUP-14A45- (or F) 24 or RM302524		RUC-1013-26-5024	
788XCXC-120A			KUP-14A45- (or F) 120 or RM302615		RUC-1013-26-5210	
788XCXC-220/240A			KUP-14A45- (or F) 240 or RM302730		RUC-1013-26-5230	
788XCX-12D			KUP-14D45- (or F) 12 or RM302012		RUC-1013-26-1012	
788XCX-24D			KUP-14D45- (or F) 24 or RM302024		RUC-1013-26-1024	
788XCXC-110D			KUP-14D45- (or F) 110 or RM302110		RUC-1013-23-1110	
MAGNECRAFT & STRUTHERS-DUNN	OMRON	TYCO / P & B / SCHRACK	IDEC	DELTROL		
A283XAXC-24A	MJN1C-AC24	KUP5A15 (or F) - 24	RR1BA-U-AC24V	20306-82		
A283XAXC-120A	MJN1C-AC120	KUP5A15 (or F) - 120	RR1BA-U-AC120V	20306-84		
A283XAXC-240A	MJN1C-AC240	KUP5A15 (or F) - 240	RR1BA-U-AC240V	20306-85		
A283XBXC-24A	MJN2C-AC24	KUP11A15 (or F) - 24	RR2BA-U-AC24V	20307-82		
A283XBXC-120A	MJN2C-AC120	KUP11A15 (or F) - 120	RR2BA-U-AC120V	20307-84		
A283XBXC-240A	MJN2C-AC240	KUP11A15 (or F) - 240	RR2BA-U-AC240V	20307-85		
A283XCXC-24A	MJN3C-AC24	KUP14A15 (or F) - 24	RR3B-U-AC24V	20308-82		
A283XCXC-120A	MJN3C-AC120	KUP14A15 (or F) - 120	RR3B-U-AC120V	20308-84		

THE CROSS REFERENCE IS INTENDED TO MATCH FOOT PRINT, INTERNAL WIRING, AND CONTACT LOAD RATINGS. CONSTRUCTION FEATURES AND GENERAL SPECIFICATIONS SHOULD BE COMPARED IF EXACT REPLACEMENT IS REQUIRED.

CROSS REFERENCE GUIDE

MAGNECRAFT & STRUTHERS-DUNN	OMRON	TYCO / POTTER & BRUMFIELD	IDEC	DELTROL
A283XCXC-240A	MJN3C-AC240	KUP14A15 (or F) - 240	RR3B-U-AC240V	20308-85
A283XAXC-12D	MJN1C-DC12	KUP5D15 (or F) - 12	RR1BA-U-DC12V	20309-81
A283XAXC-24D	MJN1C-DC24	KUP5D15 (or F) - 24	RR1BA-U-DC24V	20309-82
A283XBXC-12D	MJN2C-DC12	KUP11D15 (or F) - 12	RR2BA-U-DC12V	20310-81
A283XBXC-24D	MJN2C-DC24	KUP11D15 (or F) - 24	RR2BA-U-DC24V	20310-82
A283XBXC-110D	MJN2C-DC110	KUP11D15 (or F) - 110	RR2B-U-DC110V	20310-84
A283XCXC-12D	MJN3C-DC12	KUP14D15 (or F) - 12	RR3B-U-DC12V	20311-81
A283XCXC-24D	MJN3C-DC24	KUP14D15 (or F) - 24	RR3B-U-DC24V	20311-82
A283XAXC1-120A	MJN1CF-AC120	KUP5A55 (or F) - 120	RR1BA-US-AC120V	20545-84
A283XAXC1-240A	MJN1CF-AC240	KUP5A55 (or F) - 240	RR1BA-US-AC240V	20545-85
A283XBXC1-120A	MJN2CF-AC120	KUP11A55 (or F) - 120	RR2BA-US-AC120V	20546-84
A283XBXC1-240A	MJN2CF-AC240	KUP11A55 (or F) - 240	RR2BA-US-AC240V	20546-85
A283XCXC1-120A	MJN3CF-AC120	KUP14A55 (or F) - 120	RR3B-US-AC120V	20547-84
A283XCXC1-240A	MJN3CF-AC240	KUP14A55 (or F) - 240	RR1BA-US-DC240V	20547-85
A283XAXC1-12D	MJN1CF-DC12	KUP5D55 (or F) - 12	RR1BA-US-DC12V	20551-81
A283XAXC1-24D	MJN1CF-DC24	KUP11D55 (or F) - 24	RR2BA-US-DC24V	20551-82
A283XBXC1-12D	MJN2CF-DC12	KUP11D55 (or F) - 12	RR2BA-US-DC12V	20552-81
A283XBXC1-24D	MJN2CF-DC24	KUP11D55 (or F) - 24	RR2B-US-DC24V	20552-82
A283XCXC1-24D	MJN3CF-DC24	KUP14D55 (or F) - 24	RR3B-US-DC24V	20553-82
A283XBX69C-120A		KUEP-11A15-120		
A283XBX69C-12D		KUEP-11D15-12		
A283XBX69C-24D		KUEP-11D15-24		
A283BXX69C-24D		KUEP-7D15-24		
A283BXX69C-48D		KUEP-7D15-48		
A283XBX69C-110D		KUEP-11D15-110		
A283HXX69C-120A		KUEP-3A15-120		
A283HXX69C-12D		KUEP-3D15-12		
A283HXX69C-24D		KUEP-3D15-24		
A283HXX69C-48D		KUEP-3D15-48		
A283HXX69C-110D		KUEP-3D15-110		
MAGNECRAFT & STRUTHERS-DUNN	TYCO / POTTER & BRUMFIELD	TYCO / SCHRACK	FINDER	
388JXCXC1M-240A	KUMP-14A68-240	RM333740		
388JXCXC1M-120A	KUMP-14A68-120	RM333615		
388JXCXC1M-12D	KUMP-14D68-12	RM333012		
388JXCXC1M-24D	KUMP-14D68-24	RM333024		
388JXCXCM-240A	KUMP-14A28-240	RM332740	6233 8240 0040	
388JXCXCM-120A	KUMP-14A28-120	RM332615	6233 8120 0040	
388JXCXCM-12D	KUMP-14D28-12	RM332012	6233 9012 0040	
388JXCXCM-24D	KUMP-14D28-24	RM332024	6233 9024 0040	
388JXBXC1M-240A	KUMP-11A68-240	RM233740		
388JXBXC1M-120A	KUMP-11A68-120	RM233615		
388JXBXC1M-12D	KUMP-11D68-12	RM233012		
388JXBXC1M-24D	KUMP-11D68-24	RM233024		
388JXBXCM-240A	KUMP-11A28-240	RM232740	6232 8240 0040	
388JXBXCM-120A	KUMP-11A28-120	RM232615	6232 8120 0040	
388JXBXCM-12D	KUMP-11D28-12	RM232012	6232 9012 0040	
388JXBXCM-24D	KUMP-11D28-24	RM232024	6232 9024 0040	

THE CROSS REFERENCE IS INTENDED TO MATCH FOOT PRINT, INTERNAL WIRING, AND CONTACT LOAD RATINGS. CONSTRUCTION FEATURES AND GENERAL SPECIFICATIONS SHOULD BE COMPARED IF EXACT REPLACEMENT IS REQUIRED.

SECTION 1

CROSS REFERENCE GUIDE



MAGNECRAFT & STRUTHERS-DUNN	TYCO / POTTER & BRUMFIELD	TYCO / SCHRACK	FINDER
388VCXXCM-220/240A	KUGP-12A15-240	RM632740	62.33 8240.0310
388VCXXCM-120A	KUGP-12A15-120	RM632615	62.33 8120.0310
388VCXXCM-24A	KUGP-12A15-24	RM632524	62.32 8024.0310
388VBXXCM-220/240A	KUGP-7A15-240	RM532740	62.22 8240.0310
388VBXXCM-120A	KUGP-7A15-120	RM532615	62.23 8120.0310
388VBXXCM-24A	KUGP-7A15-24	RM532524	62.23 8024.0310
388VCXXCM-24D	KUGP-12D15-24	RM632024	62.32 9024.0310
388VCXXCM-12D	KUGP-12D15-12	RM632012	62.32 9012.0310
388VBXXCM-24D	KUGP-7D15-24	RM532024	62.32 9024.0310
388VBXXCM-12D	KUGP-7D15-12	RM532012	62.33 9012.0310
MAGNECRAFT & STRUTHERS-DUNN		TYCO / SCHRACK	FINDER
389FXCXC1M-240A		RM735740	6283 8240 0040
389FXCXC1M-120A		RM735615	6283 8120 0040
389FXBXC1M-240A		RM835740	6282 8240 0040
389FXBXC1M-120A		RM83561	6282 8240 0040
389FXCXC1M-12D		RM735024	6283 9024 0040
389FXCXC1M-24D		RM735012	6283 9012 0040
389FXBXC1M-12D		RM835024	6282 9024 0040
389FXBXC1M-24D		RM835012	6282 9012 0040
MAGNECRAFT & STRUTHERS-DUNN	TYCO / POTTER & BRUMFIELD	TYCO / SCHRACK	DELTROL
W389ADCX-4	KUMP-3A5G-120	RMD 05 615	0840-84
W389ADCX-5	KUMP-3A5G-240	RMD 05 740	20840-85
W389ADZCX-3	KUMP-6A5G-24	RMC 05 524	
W389ADZCX-4	KUMP-6A5G-120	RMC 05 615	
W389DCX-2	KUMP-3D5G-12	RMD 05 012	20848-81
W389DCX-3	KUMP-3D5G-24	RMD 05 024	20848-82
W389DZCX-2	KUMP-6D5G-12	RMC 05 012	
W389DZCX-3	KUMP-6D5G-24	RMC 05 024	
W389ACX-4	KUHP-5A51-120		
W389ACX-8	KUHP11A51-24		
W389ACX-9	KUHP11A51-120		
W389ACX-10	KUHP11A51-240		
W389ACX-14	-		
W389ACX-15	-		
W389CX-2	KUHP5D51-12		
W389CX-3	KUHP5D51-24		
W389CX-7			
W389CX-8			
W389CX-12			
W389CX-13			
MAGNECRAFT & STRUTHERS-DUNN	DELTROL		
300XBXC1-240A	20844-85		
300XBXC1-120A	20844-84		
300XBXC1-24A	20844-82		
300XBXC1-12A	20844-81		

THE CROSS REFERENCE IS INTENDED TO MATCH FOOT PRINT, INTERNAL WIRING, AND CONTACT LOAD RATINGS. CONSTRUCTION FEATURES AND GENERAL SPECIFICATIONS SHOULD BE COMPARED IF EXACT REPLACEMENT IS REQUIRED.

CROSS REFERENCE GUIDE

MAGNECRAFT & STRUTHERS-DUNN		DELTROL			
300XBXC1-110D		20852-84			
300XBXC1-24D		20852-82			
300XBXC1-12D		20852-81			
MAGNECRAFT & STRUTHERS-DUNN		TYCO / POTTER & BRUMFIELD	AMERICAN ZETTLER		
W9AS1D52-5		T9AS1D52-5	AZ2280-1A-5DEF		
W9AS1D52-12		T9AS1D52-12	AZ2280-1A-12DEF		
W9AS1D52-24		T9AS1D52-24	AZ2280-1A-24DEF		
W9AS1D52-48		T9AS1D52-48	AZ2280-1A-48DEF		
W9AS1D52-110		T9AS1D52-110	AZ2280-1A-110DEF		
W9AS5D52-5		T9AS5D52-5	AZ2280-1C-5DEF		
W9AS5D52-12		T9AS5D52-12	AZ2280-1C-12DEF		
W9AS5D52-24		T9AS5D52-24	AZ2280-1C-24DEF		
W9AS5D52-48		T9AS5D52-48	AZ2280-1C-48DEF		
W9AS5D52-110		T9AS5D52-110	AZ2280-1C-110DEF		
W9AS1A52-24			AZ2280-1A-24AEF		
W9AS1A52-120			AZ2280-1A-120AEF		
W9AS1A52-240			AZ2280-1A-240AEF		
W9AS5A52-24			AZ2280-1C-24AEF		
W9AS5A52-120			AZ2280-1C-120AEF		
W9AS5A52-240			AZ2280-1C-240AEF		
MAGNECRAFT & STRUTHERS-DUNN		TYCO / POTTER & BRUMFIELD	AMERICAN ZETTLER	OMRON	AROMAT
W92S7D22-12		T92P7D22-12	AZ2800-2A-12D	G7L-2A-TUB-CB-DC12	HE2aN-Q-DC12V
W92S7D22-24		T92P7D22-24	AZ2800-2A-24D	G7L-2A-TUB-CB-DC24	HE2aN-Q-DC24V
W92S7D22-110		T92P7D22-110	AZ2800-2A-110D	G7L-2A-TUB-CB-DC110	HE2aN-Q-DC110V
W92S11D22-12		T92P11D22-12	AZ2800-2C-12D		
W92S11D22-24		T92P11D22-24	AZ2800-2C-24D		
W92S11D22-110		T92P11D22-110	AZ2800-2C-110D		
W92S7A22-24		T92P7A22-24	AZ2800-2A-24AE	G7L-2A-TUB-CB-AC24	HE2aN-Q-AC24V
W92S7A22-120		T92P7A22-120	AZ2800-2A-120AE	G7L-2A-TUB-CB-AC120	HE2aN-Q-AC120V
W92S7A22-240		T92P7A22-240	AZ2800-2A-240AE	G7L-2A-TUB-CB-AC240	HE2aN-Q-AC240V
W92S11A22-24		T92P11A22-24	AZ2800-2C-24AE		
W92S11A22-120		T92P11A22-120	AZ2800-2C-120AE		
W92S11A22-240		T92P11A22-240	AZ2800-2C-240AE		
MAGNECRAFT & STRUTHERS-DUNN		TYCO / POTTER & BRUMFIELD			
W67RCSX-1		R10E1(X or Y)2-V28			
W67RCSX-2		R10E1(X or Y)2-V185			
W67RCSX-3		R10E1(X or Y)2-V700			
W67RCSX-4		R10E1(X or Y)2-V2.5K			
W67RCSX-5		R10E1(X or Y)2-V15.0K			
W67RCSX-6		R10E1(X or Y)4-V28			
W67RCSX-7		R10E1(X or Y)4-V185			
W67RCSX-8		R10E1(X or Y)4-V700			
W67RCSX-9		R10E1(X or Y)4-V2.5K			
W67RCSX-10		R10E1(X or Y)4-V15.0K			

THE CROSS REFERENCE IS INTENDED TO MATCH FOOT PRINT, INTERNAL WIRING, AND CONTACT LOAD RATINGS. CONSTRUCTION FEATURES AND GENERAL SPECIFICATIONS SHOULD BE COMPARED IF EXACT REPLACEMENT IS REQUIRED.

CROSS REFERENCE GUIDE

MAGNECRAFT & STRUTHERS-DUNN	TYCO / POTTER & BRUMFIELD
W67RCSX-12	R10E1(X or Y)6-V90
W67RCSX-13	R10E1(X or Y)6-V430
W67TRCSX-2	R10E1(P or Z)2-V185
W67TRCSX-3	R10E1(P or Z)2-V700
W67TRCSX-7	R10E1(P or Z)4-V185
W67TRCSX-8	R10E1(P or Z)4-V700
W67TRCSX-12	R10E1(P or Z)6-V90
W67TRCSX-13	R10E1(P or Z)6-V430
W67RPCX-2	R10E2(X or Y)2-V185
W67RPCX-3	R10E2(X or Y)2-V700
W67RPCX-7	R10E2(X or Y)4-V185
W67RPCX-8	R10E2(X or Y)4-V700
W67RPCX-12	R10E2(X or Y)6-V90
W67RPCX-13	R10E2(X or Y)6-V430
W67ARCSX-5	R10E1(X or Y)2-120V
W67ARCSX-10	R10E1(X or Y)4-120V
W67ARCSX-15	R10E1(X or Y)6-120V
W67SCSX-1	R10SE1(X or Y)2-J1.0K
W67SCSX-2	R10SE1(X or Y)2-J2.5K
W67SCSX-3	R10SE1(X or Y)2-J5.0K
W67SCSX-6	R10SE1(X or Y)4-J1.0K
W67SCSX-7	R10SE1(X or Y)4-J2.5K
W67SCSX-8	R10SE1(X or Y)4-J5.0K
MAGNECRAFT & STRUTHERS-DUNN	TYCO / POTTER & BRUMFIELD
750XBXH-12A	KR11AGE (or GF) 12
750XBXH-24A	KR11AGE (or GF) 24
750XBXH-120A	KR11AGE (or GF) 120
750XBXH-12D	KR11DGE (or GF) 12
750XBXH-24D	KR11DGE (or GF) 24
750XBXH-110D	KR11DGE (or GF) 110
750XCXH-12A	KR14AGE (or GF) 12
750XCXH-24A	KR14AGE (or GF) 24
750XCXH-120A	KR14AGE (or GF) 120
750XCXH-12D	KR14DGE (or GF) 12
750XCXH-24D	KR14DGE (or GF) 24
750XCXH-110D	KR14DGE (or GF) 110
MAGNECRAFT & STRUTHERS-DUNN	TYCO / POTTER & BRUMFIELD
W21ACPX-2	136-62T3A1

U. S. A.

MAGNECRAFT & STRUTHERS-DUNN
700 ORANGE STREET
DARLINGTON, SC. 29532-3739
TEL.: (843) 393-5421 FAX: (843) 393-4123
WEBSITE: www.magnecraft.com
EMAIL: info@magnecraft.com

EUROPE

MAGNECRAFT & STRUTHERS-DUNN
OFFICE MUNICH
FORSTENRIEDER ALLEE 227
D 81476 MUNCHEN/GERMANY
TEL.: 4989 75080310 FAX: 4989 7559344
EMAIL: renatesteinback@magnecraft.de

FOR SOCKET COMPATIBLE AND FLANGE MOUNTED RELAYS APPLICATION ENGINEERING ASSISTANCE

Chuck Johnson, PRODUCT MANAGER
FAX: (847) 441-2522
EMAIL: cjohnson@magnecraft.com

Joe Zintel, PRODUCT MANAGER
FAX: (847) 441-2522
EMAIL: jzintel@magnecraft.com



THE CROSS REFERENCE IS INTENDED TO MATCH FOOT PRINT, INTERNAL WIRING, AND CONTACT LOAD RATINGS. CONSTRUCTION FEATURES AND GENERAL SPECIFICATIONS SHOULD BE COMPARED IF EXACT REPLACEMENT IS REQUIRED.



Компания «ЭлектроПласт» предлагает заключение долгосрочных отношений при поставках импортных электронных компонентов на взаимовыгодных условиях!

Наши преимущества:

- Оперативные поставки широкого спектра электронных компонентов отечественного и импортного производства напрямую от производителей и с крупнейших мировых складов;
- Поставка более 17-ти миллионов наименований электронных компонентов;
- Поставка сложных, дефицитных, либо снятых с производства позиций;
- Оперативные сроки поставки под заказ (от 5 рабочих дней);
- Экспресс доставка в любую точку России;
- Техническая поддержка проекта, помощь в подборе аналогов, поставка прототипов;
- Система менеджмента качества сертифицирована по Международному стандарту ISO 9001;
- Лицензия ФСБ на осуществление работ с использованием сведений, составляющих государственную тайну;
- Поставка специализированных компонентов (Xilinx, Altera, Analog Devices, Intersil, Interpoint, Microsemi, Aeroflex, Peregrine, Syfer, Eurofarad, Texas Instrument, Miteq, Cobham, E2V, MA-COM, Hittite, Mini-Circuits, General Dynamics и др.);

Помимо этого, одним из направлений компании «ЭлектроПласт» является направление «Источники питания». Мы предлагаем Вам помощь Конструкторского отдела:

- Подбор оптимального решения, техническое обоснование при выборе компонента;
- Подбор аналогов;
- Консультации по применению компонента;
- Поставка образцов и прототипов;
- Техническая поддержка проекта;
- Защита от снятия компонента с производства.



Как с нами связаться

Телефон: 8 (812) 309 58 32 (многоканальный)

Факс: 8 (812) 320-02-42

Электронная почта: org@eplast1.ru

Адрес: 198099, г. Санкт-Петербург, ул. Калинина, дом 2, корпус 4, литера А.