

DS1099

Low-Frequency Dual EconOscillator

General Description

The DS1099 is a low-cost, low-power, low-frequency silicon oscillator that generates two square-wave outputs with frequencies between 0.25Hz and 1.048MHz. Individual output enables allow both outputs to be enabled/disabled independently. Both outputs are capable of sinking 16mA, allowing them to directly interface to light-emitting diodes (LEDs) as well as other external circuitry. The DS1099 operates over a wide supply voltage, making it suitable for both 3V and 5V systems. The device is shipped from the factory custom programmed and calibrated, ready to be inserted into the end application.

Contact the factory for custom frequencies or requirements.

Applications

- Flashing LED Status Indicators
- Consumer Appliances
- Servers
- Printers
- Switch-Mode Power Supplies

Features

- Low-Cost, Low-Frequency EconOscillator™ with Dual Outputs
- Factory Programmed
- Output Frequencies Independently Programmable from 0.25Hz to 1.048MHz
- 2.7V to 5.5V Single-Supply Operation
- No External Timing Components Required
- Independent Output Enables
- CMOS/TTL-Compatible Outputs
- Oscillator Outputs Capable of Sinking 16mA to Directly Drive LEDs
- Relieves Microprocessor of Periodic Interrupt
- Low-Power Consumption
- Operating Temperature Range: -40°C to +125°C
- ±100ppm/°C Temp Drift (max)

Ordering Information

PART	TEMP RANGE	PIN-PACKAGE
DS1099U- α O α 1	-40°C to +125°C	8 μ SOP

*Where α 0 and α 1 specify the factory-programmed divider settings for OUT0 and OUT1, respectively.

Ordering information is continued on the last page.

EconOscillator is a trademark of Maxim Integrated Products, Inc.

Typical Operating Circuit



Pin Configuration



Absolute Maximum Ratings

Voltage Range on V_{CC} Relative to Ground-0.5V to +6.0V
 Voltage Range on $\overline{OE0}$ and $\overline{OE1}$
 Relative to Ground-0.5V to ($V_{CC} + 0.5V$),
 not to exceed 6.0V

Operating Temperature Range..... -40°C to +125°C
 Storage Temperature Range -55°C to +125°C
 Soldering Temperature See IPC/JEDEC
 J-STD-020A Specification

Stresses beyond those listed under "Absolute Maximum Ratings" may cause permanent damage to the device. These are stress ratings only, and functional operation of the device at these or any other conditions beyond those indicated in the operational sections of the specifications is not implied. Exposure to absolute maximum rating conditions for extended periods may affect device reliability.

Recommended DC Operating Conditions

($T_A = -40^\circ\text{C}$ to $+125^\circ\text{C}$)

PARAMETER	SYMBOL	CONDITIONS	MIN	TYP	MAX	UNITS
Supply Voltage	V_{CC}	(Note 1)	2.7		5.5	V
Input Logic 1 ($\overline{OE0}$, $\overline{OE1}$)	V_{IH}		0.7 x V_{CC}		$V_{CC} +$ 0.3	V
Input Logic 0 ($\overline{OE0}$, $\overline{OE1}$)	V_{IL}		-0.3		+0.3 x V_{CC}	V

DC Electrical Characteristics

($V_{CC} = +2.7V$ to $+5.5V$, $T_A = -40^\circ\text{C}$ to $+125^\circ\text{C}$, unless otherwise noted.)

PARAMETER	SYMBOL	CONDITIONS	MIN	TYP	MAX	UNITS
Standby Supply Current	I_{STBY}	$\overline{OE0} = \overline{OE1} = V_{CC}$		145	275	μA
Active Supply Current (Note 2)	I_{CC}	$C_L = 15\text{pF}$ per output, $\overline{OE0} = \overline{OE1} = \text{GND}$, $V_{CC} = 3.3V$	1.048MHz (both)	323		μA
			4kHz (both)	146		
			1Hz (both)	145		
High-Level Output Voltage (OUT0, OUT1)	V_{OH}	$I_{OH} = -1\text{mA}$, $V_{CC} = \text{MIN}$	2.4			V
Low-Level Output Voltage (OUT0, OUT1)	V_{OL}	$I_{OL} = 16\text{mA}$ (-40°C to $+85^\circ\text{C}$) $I_{OL} = 12\text{mA}$ (-40°C to $+125^\circ\text{C}$)			0.4	V
High-Level Input Current ($\overline{OE0}$, $\overline{OE1}$)	I_{IH}	$V_{IH} = V_{CC}$			+1.0	μA
Low-Level Input Current ($\overline{OE0}$, $\overline{OE1}$)	I_{IL}	$V_{IL} = 0.0V$	-1.0			μA

AC Electrical Characteristics

(V_{CC} = +2.7V to +5.5V, T_A = -40°C to +125°C, unless otherwise noted.)

PARAMETER	SYMBOL	CONDITIONS	MIN	TYP	MAX	UNITS
Master Oscillator Frequency	f _{MOSC}			1.048		MHz
Nominal Output Frequency	f _{OUT0} , f _{OUT1}		0.25	1,048,000		Hz
Output Frequency Tolerance	Δf _{OUT}	T _A = +25°C, V _{CC} = 4.1V	-1.0		+1.0	%
Voltage Frequency Variation (Note 3)	Δf _{OUT}	T _A = +25°C		3300		ppm/V
		2.7V to 5.5V, T _A = +25°C	-2.0		+2.5	%
Temperature Frequency Variation	Δf _{OUT}	(Notes 3, 4)	-100		+100	ppm/°C
Output Duty Cycle			45		55	%
Power-Up Time	t _{PU}	(Note 5)			10	ms
Output Rise/Fall Time	t _R , t _F	C _L = 15pF (both)			20	ns

Note 1: All voltages referenced to ground.

Note 2: Active supply current combines the standby current with the output current. The output current is defined by I = (C_{LOAD} + 12pF) × V_{CC} × f_{OUT} for each output when enabled.

Note 3: This is the change observed in output frequency due to changes in temperature or voltage.

Note 4: This parameter is guaranteed by design.

Note 5: This indicates the time between power-up and the outputs becoming active.

Typical Operating Characteristics

(V_{CC} = +5.0V, T_A = +25°C, unless otherwise noted.)

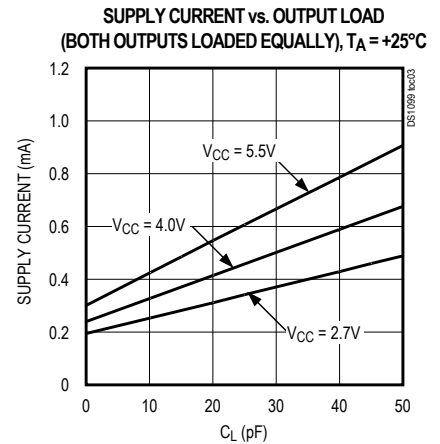
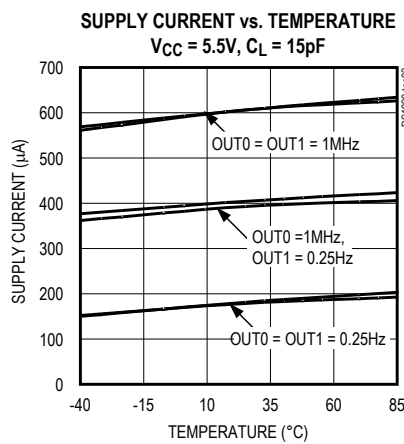
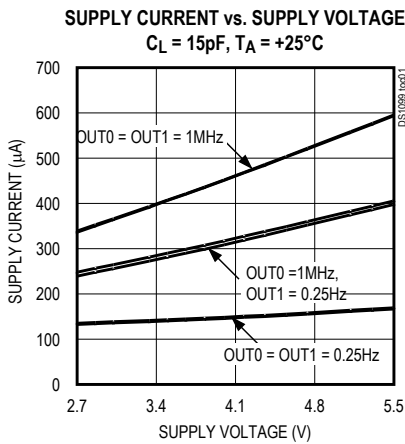

Typical Operating Characteristics (continued)

($V_{CC} = +5.0V$, $T_A = +25^\circ C$, unless otherwise noted.)

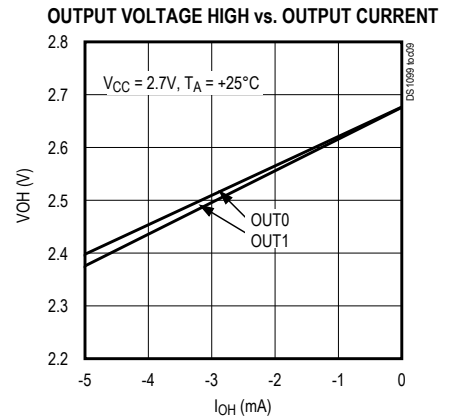
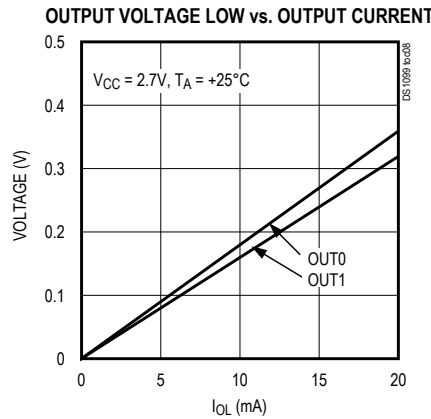
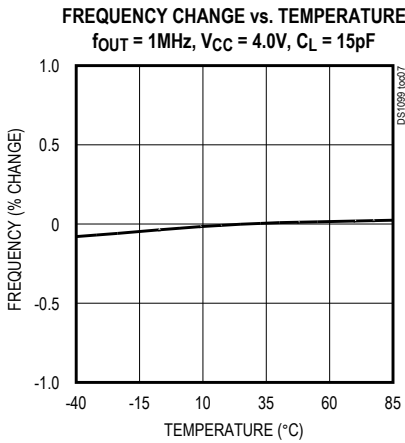
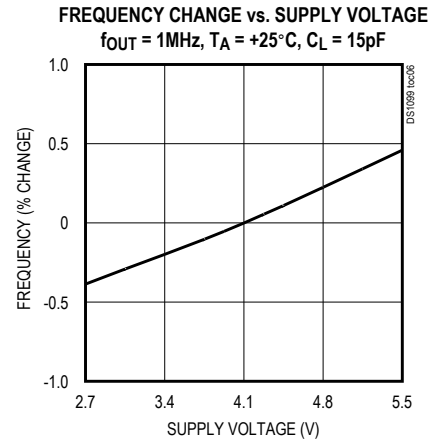
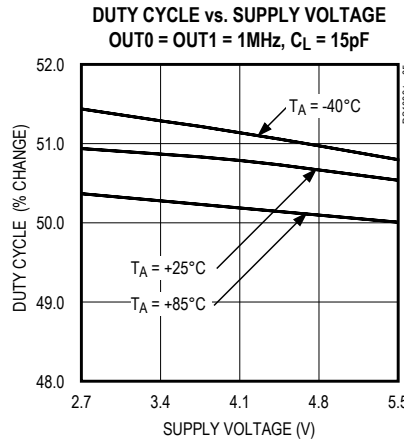
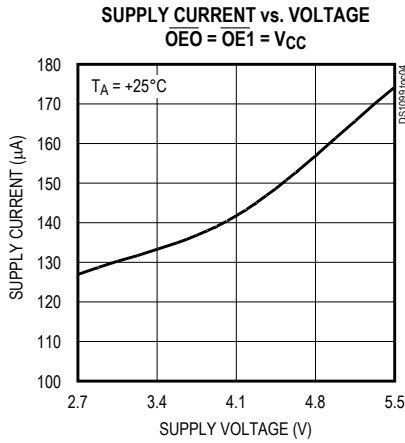

Pin Description

PIN	NAME	FUNCTION
1	OUT1	Oscillator Outputs. Each output is forced high when the corresponding \overline{OE} is high.
2	OUT0	
3	V_{CC}	Positive Supply Terminal
4	GND	Ground
5	$\overline{OE0}$	Output Enable for OUT0 and OUT1, respectively. When low, the outputs are enabled. When high, the corresponding output is disabled (forced high).
6	$\overline{OE1}$	
7, 8	N.C.	No Connection

Functional Diagram

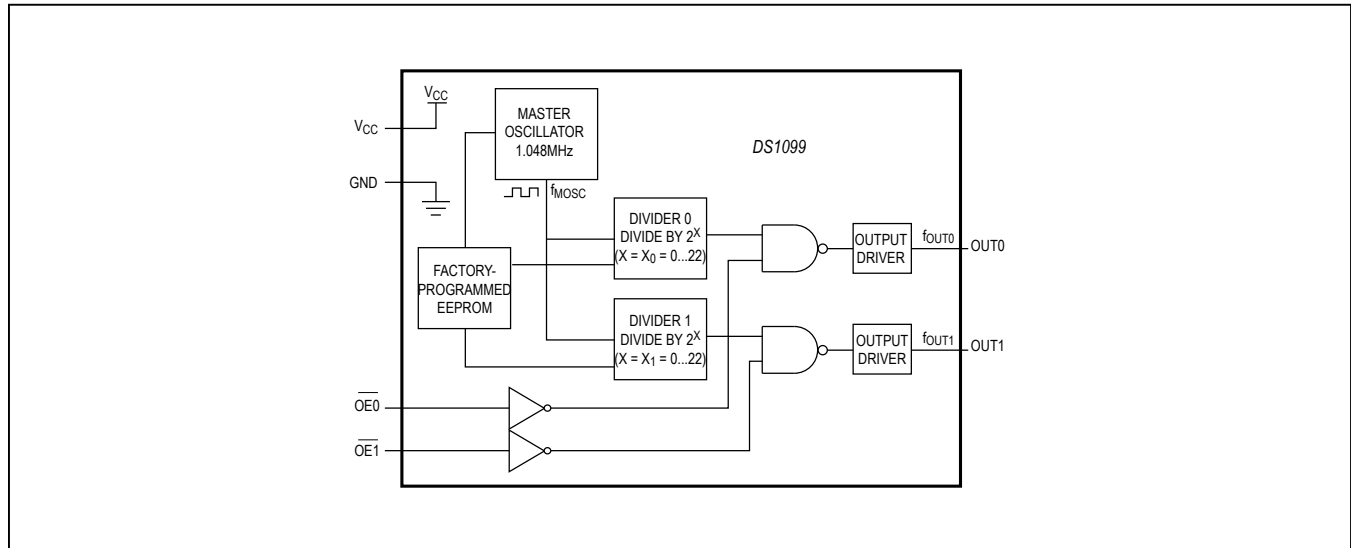

Detailed Description

The DS1099 consists of a fixed-frequency 1.048MHz master oscillator followed by two independent factory-programmable dividers. The two divider outputs are connected to pins OUT0 and OUT1, which are

Table 1. Divider Settings and Output Frequencies

DIVIDER SETTING X_0 OR X_1	DIVISOR	f_{OUT0} OR f_{OUT1}
0	1	1.048MHz
1	2	0.524MHz
2	4	0.262MHz
3	8	0.131MHz
4	16	65.50kHz
5	32	32.75kHz
—	—	—
19	524,288	2Hz
20	1,048,576	1Hz
21	2,097,152	0.5Hz
22	4,194,304	0.25Hz

independently enabled/disabled using the output-enable pins, OE0 and OE1, respectively. When the output-enable pins are active (low), the corresponding outputs are enabled. If either output-enable pin is tied to its inactive state (high), then the corresponding output is disabled and forced high immediately. The output-enable pins only disable the corresponding output driver(s) and do not shut down the master oscillator or the dividers.

Since the master oscillator frequency, f_{MOSC} , is fixed, the frequency of OUT0 and OUT1 is determined by DIVIDER 0 and DIVIDER 1, respectively. And since each output has its own divider, f_{OUT0} and f_{OUT1} can be programmed independent of each other.

The frequency of the outputs are calculated as follows:

$$f_{OUT0} = f_{MOSC} / 2^{X_0} = 1.048\text{MHz} / 2^{X_0}$$

$$f_{OUT1} = f_{MOSC} / 2^{X_1} = 1.048\text{MHz} / 2^{X_1}$$

where X_0 is the DIVIDER 0 setting and X_1 is the DIVIDER 1 setting. Valid values for X_0 and X_1 are integers 0 to 22 (dec).

Table 1 shows output frequencies and divider values for the range of divider settings.

The divider settings, X_0 and X_1 , are factory programmed. When placing an order for the DS1099, it is required to specify X_0 and X_1 . If only one output is used, it is recommended that the unused output be disabled.

The oscillator outputs are asynchronous. Since the master oscillator and dividers are free running, even when both outputs are disabled, the state of the output when \overline{OE} becomes active is unknown for up to half an f_{OUT} period. When \overline{OE} is brought low, the output is enabled instantaneously. Likewise, if the output is disabled while outputting the low half of a cycle, the output instantaneously is forced high before the current cycle is completed.

Ordering Information (continued)

α	DIVISOR	f_{OUT}
A	2^0	1.048MHz
B	2^1	0.524MHz
C	2^2	0.262MHz
D	2^3	0.131MHz
E	2^4	65.50kHz
F	2^5	32.750kHz
G	2^6	16.375kHz
H	2^7	8.187kHz
J	2^8	4.093kHz
K	2^9	2.046kHz
L	2^{10}	1.023kHz
M	2^{11}	511.7Hz
N	2^{12}	255.8Hz
P	2^{13}	127.9Hz
Q	2^{14}	63.96Hz
R	2^{15}	31.98Hz
S	2^{16}	16Hz
T	2^{17}	8Hz
U	2^{18}	4Hz
W	2^{19}	2Hz
X	2^{20}	1Hz
Y	2^{21}	0.5Hz
Z	2^{22}	0.25Hz

Branding Information

The package branding includes a0 and a1 on the top of the package next to or below 1099.

Applications Information

Power-Supply Decoupling

To achieve best results, it is highly recommended that a decoupling capacitor is used on the IC power-supply pins. Typical values of decoupling capacitors are 0.01 μ F and 0.1 μ F. Use a high-quality, ceramic, surface-mount capacitor, and mount it as close as possible to the V_{CC} and GND pins of the IC to minimize lead inductance.

Chip Topology

SUBSTRATE CONNECTED TO Ground

Package Information

For the latest package outline information and land patterns (footprints), go to www.maximintegrated.com/packages. Note that a "+", "#", or "-" in the package code indicates RoHS status only. Package drawings may show a different suffix character, but the drawing pertains to the package regardless of RoHS status.

Revision History

REVISION NUMBER	REVISION DATE	DESCRIPTION	PAGES CHANGED
1	9/07	—	1, 2, 3, 5, 6
2	5/15	Remove automotive reference from data sheet	1

For pricing, delivery, and ordering information, please contact Maxim Direct at 1-888-629-4642, or visit Maxim Integrated's website at www.maximintegrated.com.

Maxim Integrated cannot assume responsibility for use of any circuitry other than circuitry entirely embodied in a Maxim Integrated product. No circuit patent licenses are implied. Maxim Integrated reserves the right to change the circuitry and specifications without notice at any time. The parametric values (min and max limits) shown in the Electrical Characteristics table are guaranteed. Other parametric values quoted in this data sheet are provided for guidance.



Компания «ЭлектроПласт» предлагает заключение долгосрочных отношений при поставках импортных электронных компонентов на взаимовыгодных условиях!

Наши преимущества:

- Оперативные поставки широкого спектра электронных компонентов отечественного и импортного производства напрямую от производителей и с крупнейших мировых складов;
- Поставка более 17-ти миллионов наименований электронных компонентов;
- Поставка сложных, дефицитных, либо снятых с производства позиций;
- Оперативные сроки поставки под заказ (от 5 рабочих дней);
- Экспресс доставка в любую точку России;
- Техническая поддержка проекта, помощь в подборе аналогов, поставка прототипов;
- Система менеджмента качества сертифицирована по Международному стандарту ISO 9001;
- Лицензия ФСБ на осуществление работ с использованием сведений, составляющих государственную тайну;
- Поставка специализированных компонентов (Xilinx, Altera, Analog Devices, Intersil, Interpoint, Microsemi, Aeroflex, Peregrine, Syfer, Eurofarad, Texas Instrument, Miteq, Cobham, E2V, MA-COM, Hittite, Mini-Circuits, General Dynamics и др.);

Помимо этого, одним из направлений компании «ЭлектроПласт» является направление «Источники питания». Мы предлагаем Вам помощь Конструкторского отдела:

- Подбор оптимального решения, техническое обоснование при выборе компонента;
- Подбор аналогов;
- Консультации по применению компонента;
- Поставка образцов и прототипов;
- Техническая поддержка проекта;
- Защита от снятия компонента с производства.



Как с нами связаться

Телефон: 8 (812) 309 58 32 (многоканальный)

Факс: 8 (812) 320-02-42

Электронная почта: org@eplast1.ru

Адрес: 198099, г. Санкт-Петербург, ул. Калинина, дом 2, корпус 4, литера А.