



PT8510

Cable Actuated Sensor

Heavy Industrial • 0...5, 0...10 Vdc

Absolute Linear Position to 60 inches (1524 mm)

Aluminum or Stainless Steel Enclosure Options

VLS Option to Prevent Free-Release Damage

IP68 • NEMA 6 Protection

General

Full Stroke Range	0-2 to 0-60 inches
Options	
Output Signal	0...5, 0...10, -5...+5, -10...+10 VDC
Accuracy	± 1.00% to ± 0.15% full stroke (see ordering information)
Repeatability	± 0.05% full stroke
Resolution	essentially infinite
Measuring Cable	nylon-coated stainless steel or thermoplastic
Enclosure Material	powder-painted aluminum or stainless steel
Sensor	plastic-hybrid precision potentiometer
Potentiometer Cycle Life	see ordering information
Maximum Retraction	see ordering information
Acceleration	
Weight	3 lbs. (6 lbs.) max.

The PT8510 can operate from an unregulated 14.5 to 40 VDC power supply while providing an output signal that is proportional to the linear movement of its measuring cable. The PT8510 has a maximum measurement range up to 60" and has 4 output signal options to choose from: 0...10, 0...5, -10...+10 and -5...+5 Vdc.

As a member of our innovative family of NEMA-4 rated cable-extension transducers, the PT8510 offers numerous benefits. It installs in minutes, fits into areas unsuited for rod-type measurement devices, and works without perfectly parallel alignment.

Output Signal

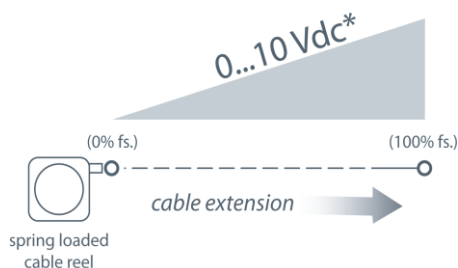

**Also Available: 0...5, -5...+5, -10...+10 Vdc*

Electrical

Input Voltage	see ordering information
Input Current	10 mA maximum
Output Impedance	1000 ohms
Maximum Load	5000 ohms
Zero and Span Adjustment	see ordering information

Environmental

Enclosure	NEMA 4/4X/6, IP 67/68
Operating Temperature	-40° to 200°F (-40° to 90°C)
Vibration	up to 10 g to 2000 Hz maximum

PT8510

Heavy Industrial • 0...5, 0...10 Vdc

Outline Drawing:

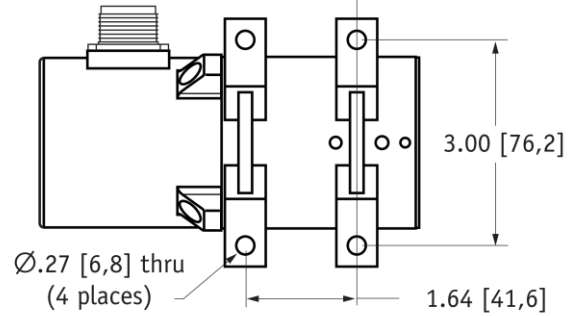
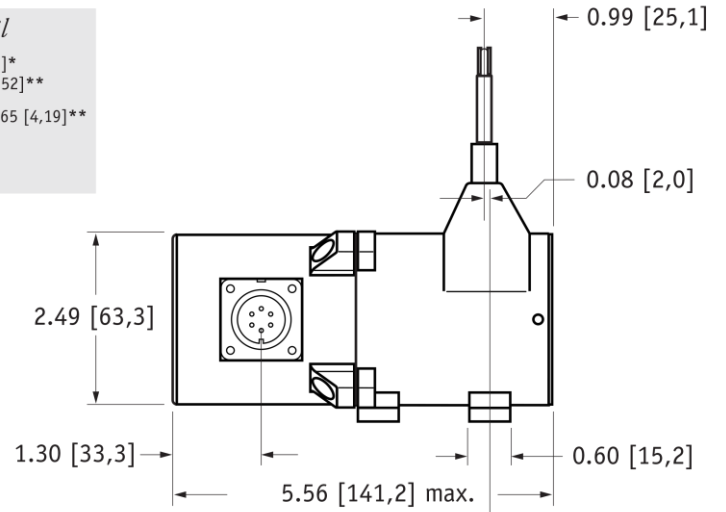
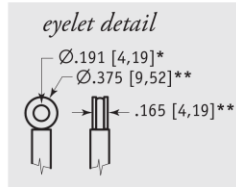
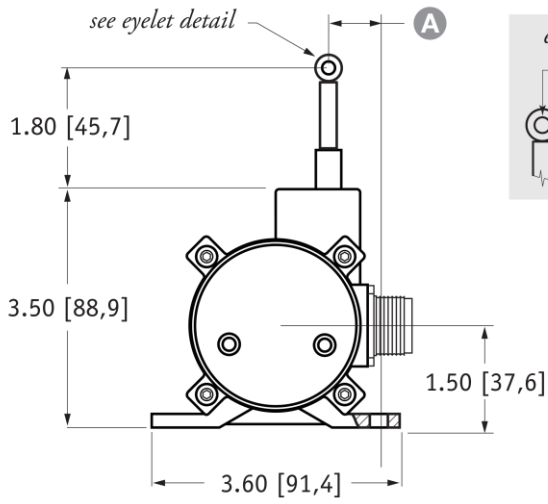

RANGE		A
2", 10"	1.16 [29,5]	
5", 25", 50"	0.66 [16,8]	
15"	0.99 [25,7]	
20", 40"	0.85 [21,6]	
30", 60"	0.52 [13,3]	

DIMENSIONS ARE IN INCHES [MM]
 tolerances are ±0.02 in. [±0,5 mm] unless otherwise noted
 note: *tolerance = +.005 -.001 [+.13 -.03] **tolerance = +.005 -.005 [+.-.13 -.13]

PT8510

Heavy Industrial • 0...5, 0...10 Vdc

Ordering Information

Model Number:

PT8510- _____ **1** - **1** _____
order code: R A B C D E F G

Sample Model Number:

PT8510 - 0030 - 111 - 1110

- R** range: 30 inches
- A** enclosure/cable tension: aluminum/standard (9 oz.)
- B** measuring cable: .034 nylon-coated stainless
- E** output signal: 0...10 vdc
- F** electrical connection: 6-pin plastic connector
- G** cable guide option: standard nylon cable guide

Full Stroke Range:

R order code:	0002	0005	0010	0015	0020	0025	0030	0040	0050	0060
full stroke range, min:	2 in.	5 in.	10 in.	15 in.	20 in.	25 in.	30 in.	40 in.	50 in.	60 in.
accuracy (% of f.s.):	1.00%	1.00%	0.18%	0.18%	0.18%	0.18%	0.18%	0.15%	0.15%	0.15%
potentiometer cycle life*:	2.5 x 10 ⁶	2.5 x 10 ⁶	5 x 10 ⁵	5 x 10 ⁵	5 x 10 ⁵	5 x 10 ⁵	5 x 10 ⁵	2.5 x 10 ⁵	2.5 x 10 ⁵	2.5 x 10 ⁵

*-1 cycle is defined as the travel of the measuring cable from full retraction to full extension and back to full retraction

Enclosure Material and Measuring Cable Tension:

A order code:	1	5	2	3	6	4	8	7	9
enclosure:	aluminum			303 stainless			316 stainless		
cable tension:	standard	medium	high	standard	medium	high	standard	medium	high
max. acceleration:	15 g	25 g	40 g	6 g	12 g	18 g	6 g	12 g	18 g

cable tension option specifications	Range:	2 in.	5 in.	10 in.	15 in.	20 in.	25 in.	30 in.	40 in.	50 in.	60 in.
	Standard:	39 oz.	16 oz.	39 oz.	26 oz.	20 oz.	16 oz.	13 oz.	20 oz.	16 oz.	13 oz.
	Medium:	65 oz.	26 oz.	65 oz.	43 oz.	33 oz.	26 oz.	22 oz.	33 oz.	26 oz.	22 oz.
	High:	116 oz.	47 oz.	116 oz.	77 oz.	60 oz.	47 oz.	40 oz.	60 oz.	47 oz.	40 oz.

tension tolerance: ± 50%

Measuring Cable:

B order code:	1	2	3	4
cable construction:	Ø.034-inch nylon-coated stainless steel rope	Ø.047-inch bare stainless steel rope	Ø.058-inch PVC jacketed vectra fiber rope	Ø.031-inch bare stainless steel rope
available ranges:	all ranges	5, 15, 20, 25, 30-inch only	thru 30 inches only	40, 50, 60-inch only
general use:	indoor	outdoor, debris, high temperature	high voltage or magnetic field	outdoor, debris, high temperature

Output Signals:





F order code:	1	2	3	4	5	6	7	8
output signal options:	0...10 VDC	10...0 VDC	0...5 VDC	5...0 VDC	-10...+10 VDC	+10...-10 VDC	-5...+5 VDC	+5...-5 VDC
input voltage:	14.5 - 40 vdc		10.5 - 40 vdc		14.5 - 40 vdc		10.5 - 40 vdc	
span adjustment:	to 50% of factory set span				to 75% of factory set span			
zero adjustment:	from factory set zero to 50% of full stroke range				from factory set zero to 25% of full stroke range			

Example:

ordercode = **1** = 0...10 vdc

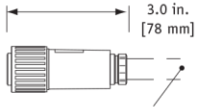
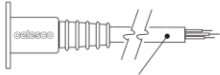
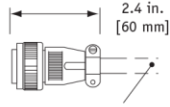

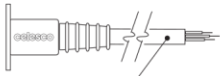
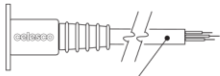
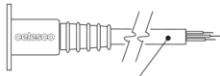
Electrical Connection:

<p>F <i>order code:</i> 1</p> <p>6-pin plastic connector w/mating plug IP 67, NEMA 4X** ,6</p>  <p>1/2 - 5/16" [14 - 8 mm] cable dia. 16 AWG max conductor size connector: MS3102E-14S-6P mating plug: MS3106E-14S-6S</p>	<p>2</p> <p>10-ft. [3 M] waterproof cable IP 67, NEMA 4X** , 6</p>  <p>10 ft. x 0.4-in. dia. [3 M x 10 mm dia.] 3-conductor, 18 AWG type SJTOW</p>	<p>3</p> <p>6-pin metal connector w/mating plug IP 65, NEMA 4</p>  <p>3/8-in. [9 mm] max cable dia. 16 AWG max conductor size connector: MS3102E-14S-6P mating plug: MS3106E-14S-6S</p>	<p>4</p> <p>25-ft. [7.5 M] instrumentation cable IP 67, NEMA 6</p>  <p>25 ft. x 0.2-in. dia. [7.5 M x 5 mm dia.] 6-conductor, 24 AWG shielded</p>																								
<p>F <i>order code:</i> 5</p> <p>100-ft. [30 M] waterproof cable IP 67, NEMA 4X** ,6</p>  <p>100 ft. x 0.4-in. dia. [30 M x 10 mm dia.] 18 AWG, type SJTOW</p>	<p>6</p> <p>10-ft. [3 M] pressure tested* waterproof cable IP 68, NEMA 4X** , 6P</p>  <p>10 ft. x 0.4-in. dia. [3 M x 10 mm dia.] 3-conductor, 18 AWG type SJTOW</p>	<p>7</p> <p>100-ft. [30 M] pressure tested* waterproof cable IP 68, NEMA 4X** , 6P</p>  <p>100 ft. x 0.4-in. dia. [30 M x 10 mm dia.] 3-conductor, 18 AWG type SJTOW</p>																									
<p>6-pin Mating Plug</p> <table border="1"> <tr> <th>pin</th> <th>signal</th> </tr> <tr> <td>A</td> <td>input voltage</td> </tr> <tr> <td>B</td> <td>output signal</td> </tr> <tr> <td>C</td> <td>common</td> </tr> </table>  <p><i>contact view</i></p>	pin	signal	A	input voltage	B	output signal	C	common	<p>Waterproof Cable</p> <table border="1"> <tr> <th>color code</th> <th>signal</th> </tr> <tr> <td>WHITE</td> <td>input voltage</td> </tr> <tr> <td>GREEN</td> <td>output signal</td> </tr> <tr> <td>BLACK</td> <td>common</td> </tr> </table>	color code	signal	WHITE	input voltage	GREEN	output signal	BLACK	common	<p>Instrumentation Cable</p> <table border="1"> <tr> <th>color code</th> <th>signal</th> </tr> <tr> <td>RED</td> <td>input voltage</td> </tr> <tr> <td>GREEN</td> <td>output signal</td> </tr> <tr> <td>BLACK</td> <td>common</td> </tr> </table> <p><i>Note: WHITE, BLUE, BROWN are not used.</i></p>	color code	signal	RED	input voltage	GREEN	output signal	BLACK	common	
pin	signal																										
A	input voltage																										
B	output signal																										
C	common																										
color code	signal																										
WHITE	input voltage																										
GREEN	output signal																										
BLACK	common																										
color code	signal																										
RED	input voltage																										
GREEN	output signal																										
BLACK	common																										

*-Test pressure: 100 feet [30 meters] H₂O (40 PSID); Test Medium: Air; Duration: 2 hours. **-Applies to stainless steel enclosure only.

Cable Guide Options:

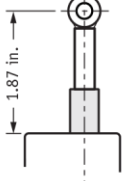
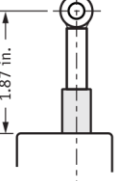
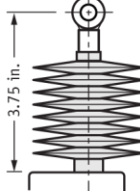
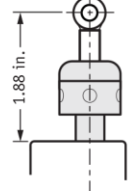
<p>G <i>order code:</i> 0</p> <p>standard cable guide</p>  <p>1.87 in.</p>	<p>1</p> <p>stainless steel cable guide</p>  <p>1.87 in.</p>	<p>2*</p> <p>polyurethane cable bellows</p>  <p>3.75 in.</p>	<p>3</p> <p>integral cable brush</p>  <p>1.88 in.</p>
---	--	--	---

*note: all ranges up to 25 inches only

Output Signal Selection (does not apply to -5...+5 and -10...+10 VDC options)

The output signal direction can be reversed at any time by simply changing the dip-switch settings found on the internal signal board. After the settings have been changed, adjustment of the Zero and Span trim pots will be required to precisely match signal values to the beginning and end points of the stroke.

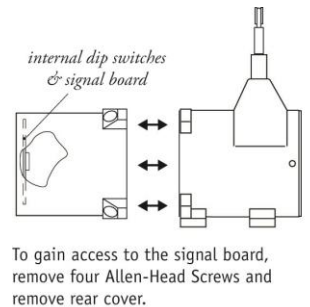
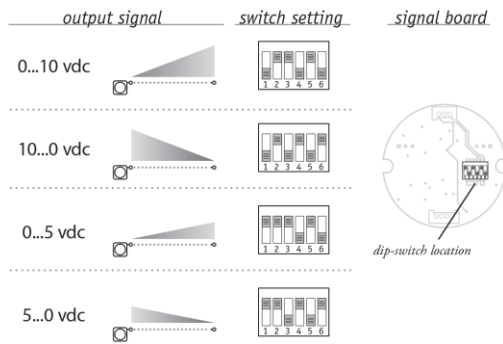

VLS Option - Free Release Protection

The patented Celesco Velocity Limiting System (VLS) is an option for PT8000 Series cable extension transducers that limits cable retraction to a safe 40 to 55 inches per second.

The VLS option prevents the measuring cable from ever reaching a damaging velocity during an accidental free release. This option is ideal for mobile applications that require frequent cable disconnection and reconnection. It prevents expensive unscheduled downtime due to accidental cable mishandling or attachment failure.

VLS is NOT available for medium and high cable tension options or 2, 5 and 15-inch stroke ranges.

How to Configure Model Number for VLS

VLS8510-	-	1	-	1	-	1	0
0015		1		1		1	0
0020		2		2		2	1
0025		3		3		3	3
0030		4		4		4	4
0040				5		5	5
0050				6		6	6
0060				7		7	7
				8			

■ = available options**

creating VLS model number (example):

1. select PT8420 model **PT8510-0060-111-1110**
2. remove "PT" from the model number **8510-0060-111-1110**
3. add "VLS" **VLS + 8510-0060-111-1110**
4. completed model number! **VLS8510-0060-111-1110**

**Note: please contact factory for a solution to options not supported.

NORTH AMERICA

Measurement Specialties, Inc.,
 a TE Connectivity company
 20630 Plummer Street
 Chatsworth, CA 91311
 Tel +1 800 423 5483
 Tel +1 818 701 2750
 Fax +1 818 701 2799
 info@celesco.com

TE.com/sensorsolutions

Measurement Specialties, Inc., a TE Connectivity company.

Measurement Specialties, TE Connectivity, TE Connectivity (logo) and EVERY CONNECTION COUNTS are trademarks. All other logos, products and/or company names referred to herein might be trademarks of their respective owners.

The information given herein, including drawings, illustrations and schematics which are intended for illustration purposes only, is believed to be reliable. However, TE Connectivity makes no warranties as to its accuracy or completeness and disclaims any liability in connection with its use. TE Connectivity's obligations shall only be as set forth in TE Connectivity's Standard Terms and Conditions of Sale for this product and in no case will TE Connectivity be liable for any incidental, indirect or consequential damages arising out of the sale, resale, use or misuse of the product. Users of TE Connectivity products should make their own evaluation to determine the suitability of each such product for the specific application.

© 2015 TE Connectivity Ltd. family of companies All Rights Reserved.

PT8510 12/01/2015



Компания «ЭлектроПласт» предлагает заключение долгосрочных отношений при поставках импортных электронных компонентов на взаимовыгодных условиях!

Наши преимущества:

- Оперативные поставки широкого спектра электронных компонентов отечественного и импортного производства напрямую от производителей и с крупнейших мировых складов;
- Поставка более 17-ти миллионов наименований электронных компонентов;
- Поставка сложных, дефицитных, либо снятых с производства позиций;
- Оперативные сроки поставки под заказ (от 5 рабочих дней);
- Экспресс доставка в любую точку России;
- Техническая поддержка проекта, помощь в подборе аналогов, поставка прототипов;
- Система менеджмента качества сертифицирована по Международному стандарту ISO 9001;
- Лицензия ФСБ на осуществление работ с использованием сведений, составляющих государственную тайну;
- Поставка специализированных компонентов (Xilinx, Altera, Analog Devices, Intersil, Interpoint, Microsemi, Aeroflex, Peregrine, Syfer, Eurofarad, Texas Instrument, Miteq, Cobham, E2V, MA-COM, Hittite, Mini-Circuits, General Dynamics и др.);

Помимо этого, одним из направлений компании «ЭлектроПласт» является направление «Источники питания». Мы предлагаем Вам помощь Конструкторского отдела:

- Подбор оптимального решения, техническое обоснование при выборе компонента;
- Подбор аналогов;
- Консультации по применению компонента;
- Поставка образцов и прототипов;
- Техническая поддержка проекта;
- Защита от снятия компонента с производства.



Как с нами связаться

Телефон: 8 (812) 309 58 32 (многоканальный)

Факс: 8 (812) 320-02-42

Электронная почта: org@eplast1.ru

Адрес: 198099, г. Санкт-Петербург, ул. Калинина, дом 2, корпус 4, литера А.