

# G9EA-1

DC Power Relays (60-A, 100-A Models)



## DC Power Relays Capable of Interrupting High-voltage, High-current Loads

- A compact relay (73 x 36 x 67.2 mm (L x W x H)) capable of switching 400-V 60-A DC loads. (Capable of interrupting 600 A at 300 VDC max.)
- The switching section and driving section are gas-injected and hermetically sealed, allowing these compact relays to interrupt high-capacity loads. The sealed construction also requires no arc space, saves space, and helps ensure safe applications.
- Downsizing and optimum design allow no restrictions on the mounting direction.
- Terminal Cover and DIN Track Adapters are also available for industrial applications.
- UL/CSA standard UL508 approved.

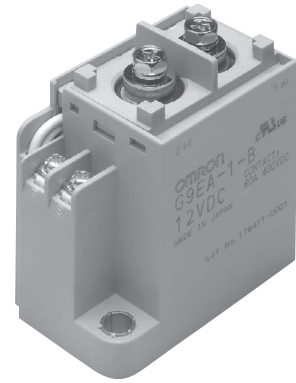

**RoHS Compliant**

Refer to "DC Power Relays Common Precautions".

### Model Number Legend

G9EA-  -  -  -  

1   2   3   4

**1. Number of Poles**  
1: 1 pole

**2. Contact Form**  
Blank: SPST-NO

**3. Coil Terminals**

B: M3.5 screw terminals  
Blank: Lead wire output

**4. Special Functions**

CA: High-current conduction (100 A)

### List of Models

Classification	Terminals		Contact form	Rated coil voltage	Model
	Coil terminals	Contact terminals			
Switching/current conduction models	Screw terminals	Screw terminals	SPST-NO	12 VDC	G9EA-1-B
	Lead wires			24 VDC	G9EA-1
High-current conduction models	Screw terminals			48 VDC	G9EA-1-B-CA
	Lead wires			60 VDC 100 VDC	G9EA-1-CA

Note 1. Two M5 screws are provided for the contact terminal connection.

Note 2. Two M3.5 screws are provided for the coil terminal connection.

### Ratings

#### Coil

Rated voltage	Item	Rated current (mA)	Coil resistance (Ω)	Must-operate voltage (V)	Must-release voltage (V)	Maximum voltage (V)	Power consumption (W)
12 VDC		417	28.8	75% max. of rated voltage	8% min. of rated voltage	130% of rated voltage (at 23°C within 10 minutes)	Approx. 5 W
24 VDC		208	115.2				
48 VDC		102	469.3				
60 VDC		86.2	695.7				
100 VDC		53.6	1864				
							Approx. 5.2 W
							Approx. 5.4 W

Note 1. The figures for the rated current and coil resistance are for a coil temperature of 23°C and have a tolerance of ±10%.

Note 2. The figures for the operating characteristics are for a coil temperature of 23°C.

Note 3. The figure for the maximum voltage is the maximum voltage that can be applied to the relay coil.

#### Contacts

Item	Resistive load	
	G9EA-1(-B)	G9EA-1(-B)-CA
Rated load	60 A at 400 VDC, 100 A at 120 VDC	30 A at 400 VDC
Rated carry current	60 A	100 A
Maximum switching voltage	400 V	400 V
Maximum switching current	100 A	30 A

### Characteristics

Item	Model	G9EA-1(-B)	G9EA-1(-B)-CA
Contact resistance 1		30 mΩ max. (0.6 mΩ typical)	10 mΩ max. (0.3 mΩ typical)
Contact voltage drop		0.1 V max. (for a carry current of 60 A)	0.1 V max. (for a carry current of 100 A)
Operate time		50 ms max.	
Release time		30 ms max.	
Insulation resistance	Between coil and contacts	1,000 MΩ min.	
	Between contacts of the same polarity	1,000 MΩ min.	
Dielectric strength *2	Between coil and contacts	2,500 VAC, 1 min	
	Between contacts of the same polarity	2,500 VAC, 1 min	
Impulse withstand voltage *3		4,500 V	
Vibration resistance	Destruction	10 to 55 to 10 Hz, 0.75-mm single amplitude (Acceleration: 2.94 to 88.9 m/s <sup>2</sup> )	
	Malfunction	10 to 55 to 10 Hz, 0.75-mm single amplitude (Acceleration: 2.94 to 88.9 m/s <sup>2</sup> )	
Shock resistance	Destruction	490 m/s <sup>2</sup>	
	Malfunction	196 m/s <sup>2</sup>	
Mechanical endurance *4		200,000 ops. min.	
Electrical endurance (resistive load) *5		120 VDC, 100 A, 3,000 ops. min.	400 VDC, 30 A, 1,000 ops. min.
		400 VDC, 60 A, 3,000 ops. min.	120 VDC, 30 A, 2,500 ops. min.
		400 VDC, 30 A, 30,000 ops. min.	-
Short-time carry current		100 A (10 min)	150 A (10 min)
Maximum interruption current		600 A at 300 VDC (5 times)	-
Overload interruption		180 A at 400 VDC (100 times min.)	100 A at 120 VDC (150 times min.)
Reverse polarity interruption		-60 A at 200 VDC (1,000 times min.)	-
Ambient operating temperature		-40 to 70°C (with no icing or condensation)	
Ambient operating humidity		5% to 85% RH	
Weight (including accessories)		Approx. 310 g	

Note. The above values are initial values at an ambient temperature of 23°C unless otherwise specified.

\*1. The contact resistance was measured with 1A at 5VDC using the voltage drop method.

\*2. The insulation resistance was measured with a 500-VDC megohmmeter.

\*3. The impulse withstand voltage was measured with a JEC-212 (1981) standard impulse voltage waveform (1.2 × 50 μs).

\*4. The mechanical endurance was measured at a switching frequency of 3,600 operations/hr.

\*5. The electrical endurance was measured at a switching frequency of 60 operations/hr.

### Engineering Data

#### G9EA-1(-B) Switching/Current Conduction Models

##### ● Maximum Switching Capacity

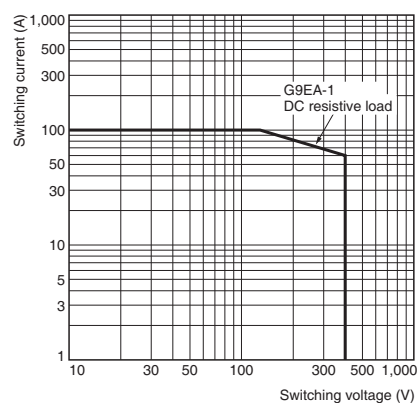

##### ● Electrical Endurance (Switching Performance)

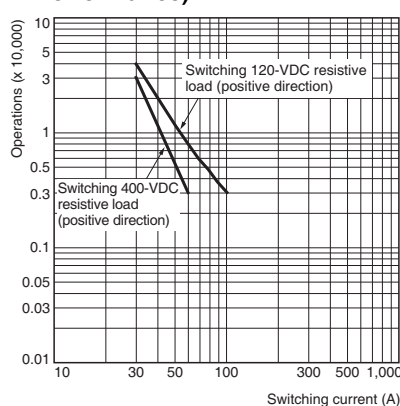

##### ● Electrical Endurance (Interruption Performance)

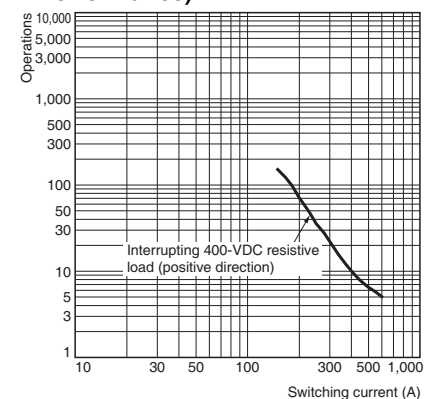

##### ● Carry Current vs Energizing Time

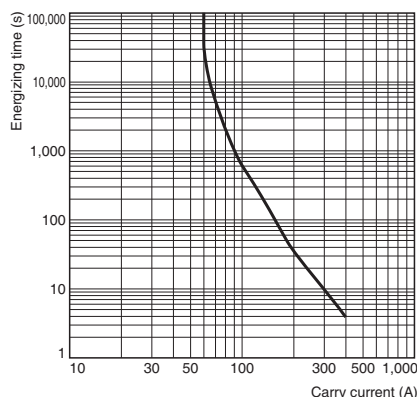

## G9EA-1(B)-CA High-current Conduction Models

### ● Maximum Switching Capacity

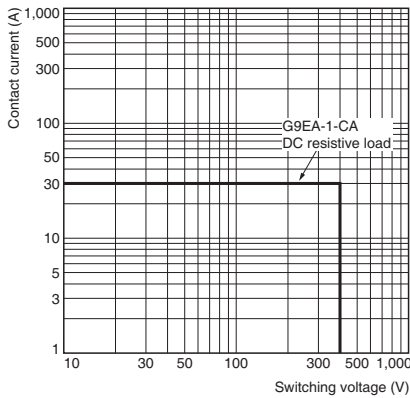

### ● Electrical Endurance (Switching Performance)

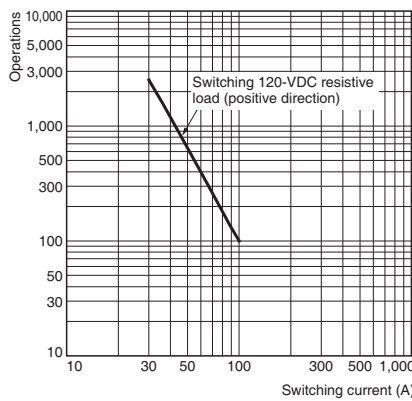

### ● Carry Current vs Energizing Time

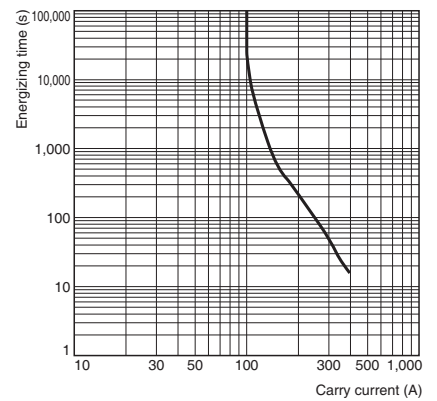

## All G9EA-1 Models

### ● Must-operate Voltage and Must-release Voltage Distributions

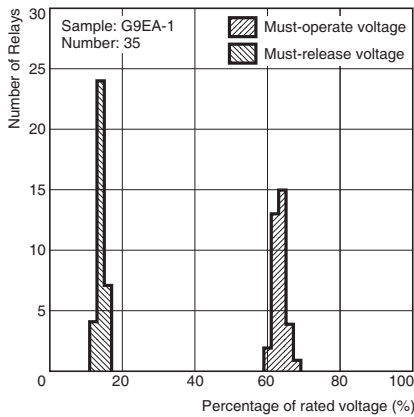

### ● Time Characteristic Distributions

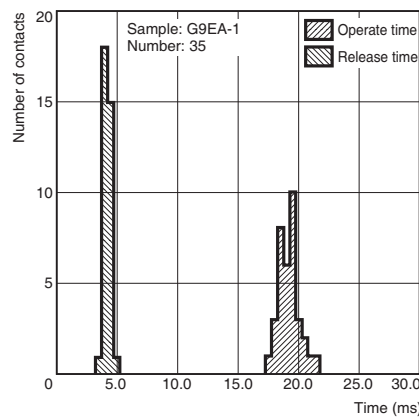

### ● Vibration Malfunction

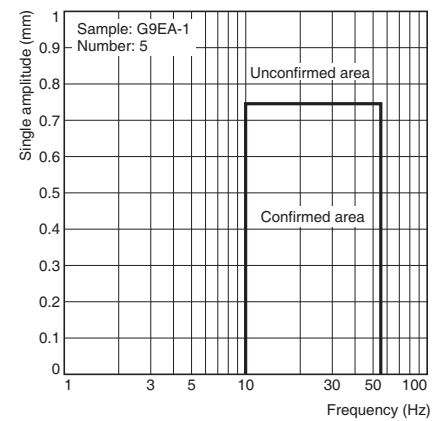

### ● Vibration Resistance

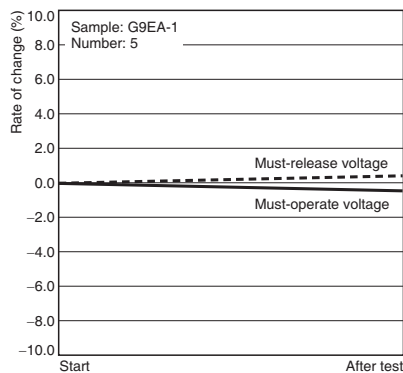

Characteristics were measured after applying vibration at a frequency of 10 to 55 Hz (single amplitude of 0.75 mm) to the test piece (not energized) for 2 hours each in 3 directions. The percentage rate of change is the average value for all of the samples

### ● Shock Malfunction

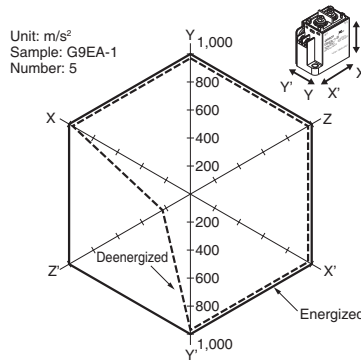

The value at which malfunction occurred was measured after applying shock to the test piece 3 times each in 6 directions along 3 axes.

### ● Shock Resistance

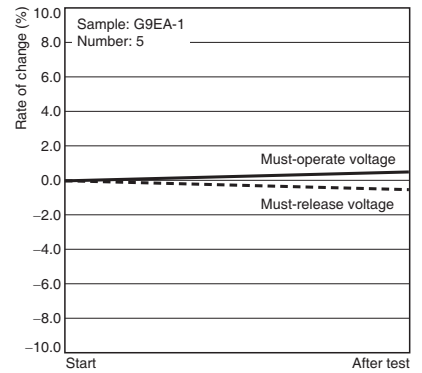

Characteristics were measured after applying a shock of 490 m/s² to the test piece 3 times each in 6 directions along 3 axes. The percentage rate of change is the average value for all of the samples.

# G9EA-1

## DC Power Relays (60-A, 100-A Models)

### ■ Dimensions (Unit: mm)

#### ● Models with Screw Terminals G9EA-1-B(-CA)

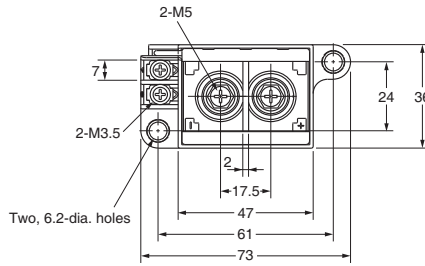
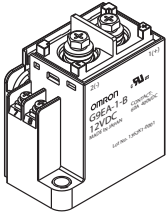

#### Terminal Arrangement/ Internal Connections (TOP VIEW)

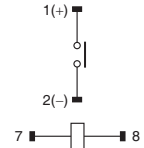

Note: Be sure to connect terminals with the correct polarity. Coils do not have polarity.

#### Mounting Hole Dimensions (TOP VIEW)

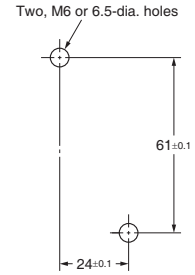

Dimension (mm)	Tolerance (mm)
10 or lower	±0.3
10 to 50	±0.5
50 or higher	±1

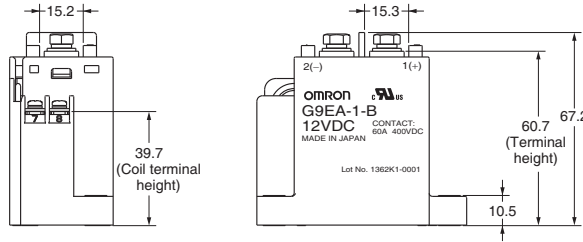

#### ● Models with Lead Wires G9EA-1(-CA)

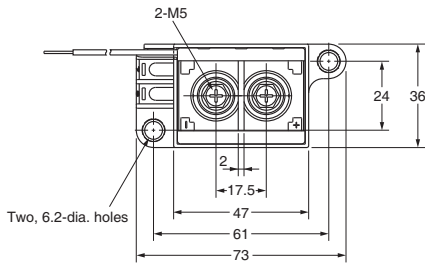
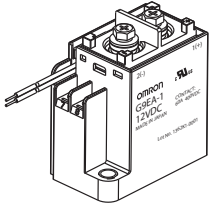

#### Terminal Arrangement/ Internal Connections (TOP VIEW)

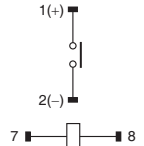

Note: Be sure to connect terminals with the correct polarity. Coils do not have polarity.

#### Mounting Hole Dimensions (TOP VIEW)

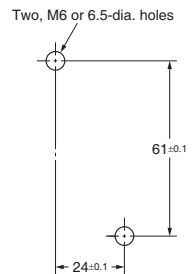

Dimension (mm)	Tolerance (mm)
10 or lower	±0.3
10 to 50	±0.5
50 or higher	±1

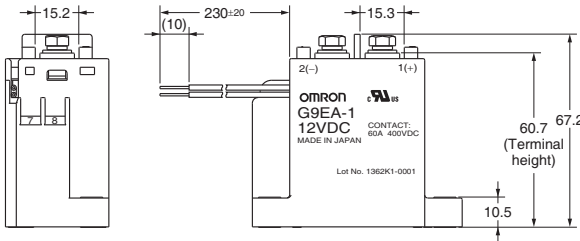

### Options (Unit: mm)

#### Terminal Cover

P9EA-C

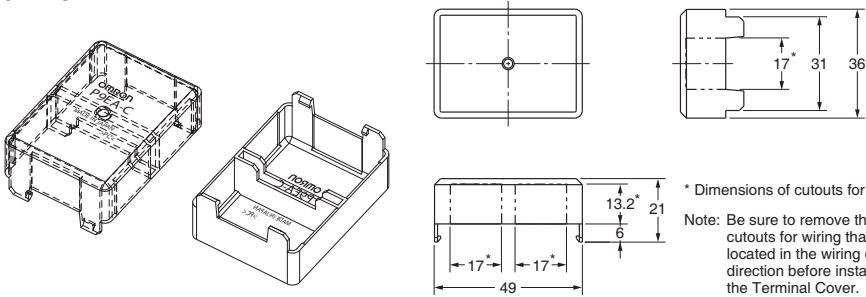

\* Dimensions of cutouts for wiring.

Note: Be sure to remove the cutouts for wiring that are located in the wiring outlet direction before installing the Terminal Cover.

Dimension (mm)	Tolerance (mm)
10 or lower	±0.3
10 to 50	±0.5
50 or higher	±1

#### DIN Track Adapter

P9EA-D

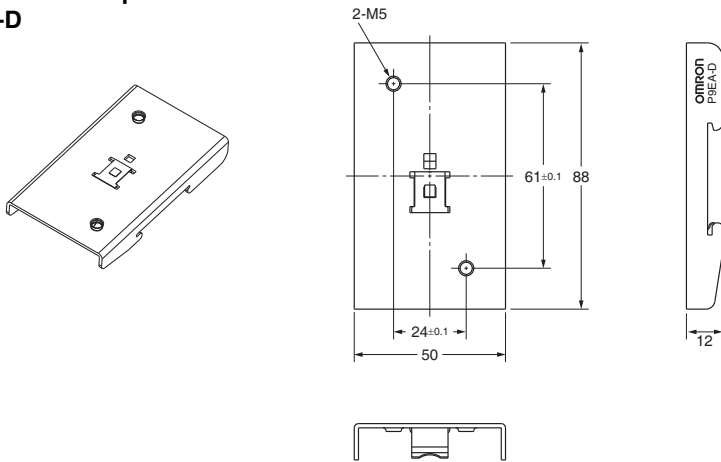

Dimension (mm)	Tolerance (mm)
10 or lower	±0.3
10 to 50	±0.5
50 or higher	±1

G  
9  
E  
A  
·  
1

• Application examples provided in this document are for reference only. In actual applications, confirm equipment functions and safety before using the product.  
• Consult your OMRON representative before using the product under conditions which are not described in the manual or applying the product to nuclear control systems, railroad systems, aviation systems, vehicles, combustion systems, medical equipment, amusement machines, safety equipment, and other systems or equipment that may have a serious influence on lives and property if used improperly. Make sure that the ratings and performance characteristics of the product provide a margin of safety for the system or equipment, and be sure to provide the system or equipment with double safety mechanisms.

**Note: Do not use this document to operate the Unit.**



Компания «ЭлектроПласт» предлагает заключение долгосрочных отношений при поставках импортных электронных компонентов на взаимовыгодных условиях!

Наши преимущества:

- Оперативные поставки широкого спектра электронных компонентов отечественного и импортного производства напрямую от производителей и с крупнейших мировых складов;
- Поставка более 17-ти миллионов наименований электронных компонентов;
- Поставка сложных, дефицитных, либо снятых с производства позиций;
- Оперативные сроки поставки под заказ (от 5 рабочих дней);
- Экспресс доставка в любую точку России;
- Техническая поддержка проекта, помощь в подборе аналогов, поставка прототипов;
- Система менеджмента качества сертифицирована по Международному стандарту ISO 9001;
- Лицензия ФСБ на осуществление работ с использованием сведений, составляющих государственную тайну;
- Поставка специализированных компонентов (Xilinx, Altera, Analog Devices, Intersil, Interpoint, Microsemi, Aeroflex, Peregrine, Syfer, Eurofarad, Texas Instrument, Miteq, Cobham, E2V, MA-COM, Hittite, Mini-Circuits, General Dynamics и др.);

Помимо этого, одним из направлений компании «ЭлектроПласт» является направление «Источники питания». Мы предлагаем Вам помощь Конструкторского отдела:

- Подбор оптимального решения, техническое обоснование при выборе компонента;
- Подбор аналогов;
- Консультации по применению компонента;
- Поставка образцов и прототипов;
- Техническая поддержка проекта;
- Защита от снятия компонента с производства.



#### Как с нами связаться

**Телефон:** 8 (812) 309 58 32 (многоканальный)

**Факс:** 8 (812) 320-02-42

**Электронная почта:** [org@eplast1.ru](mailto:org@eplast1.ru)

**Адрес:** 198099, г. Санкт-Петербург, ул. Калинина, дом 2, корпус 4, литера А.