

Terminal Relay G6B-4□□ND

Compact Terminal Relay with 4 Independent Outputs

- Equipped with four G6B Mini-relays that are compact, highly sensitive, and highly resistant to dielectric surges, and that can switch 5 amps of power.
- Sealed plastic construction used for relays.
- Easy wiring with separated input/output terminals.
- Special P6B Mounting Socket used to facilitate maintenance (except for high-reliability models).
- Standard models meet UL508 and CSA requirements.
- DIN Track mounting, and screw mounting models are available.

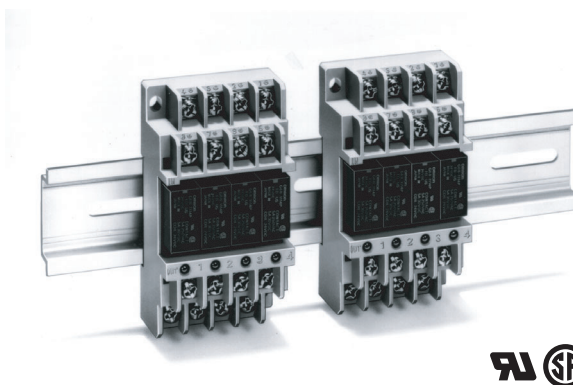

Model Number Structure

■ Model Number Legend

G6B-□□□ND
1 2 3

Note: UL508 and CSA requirements met by standard models.

1. Number of Poles

- 4: 4 poles (4PST-NO standard circuit)
- 47: 4 poles (4PST-NO long-life circuit)
- 48: 4 poles (4PST-NO high-reliability circuit)

2. Mounting

- None: DIN Track or screw mounting
- F: Screw mounting

3. Input Terminal

- B: Phillips screw (3.5 mm) terminals (4 independent points)
- B1: Flat-bladed screw terminals (4 points with same common)
- P: Connector terminals (4 independent points)

Ordering Information

■ List of Models

Classification	Contact form	Mounting method	Terminals	Rated voltage	Model
Equipped with operation indicator and diode to absorb coil surge	4PST (standard)	DIN Track or screw mounting	Phillips screw terminal	5 VDC 12 VDC 24 VDC	G6B-4BND
	4PST (long-life)	DIN Track or screw mounting	Phillips screw terminal	5 VDC 12 VDC 24 VDC	G6B-47BND
	4PST (high reliability)	DIN Track or screw mounting	Phillips screw terminal	5 VDC 12 VDC 24 VDC	G6B-48BND
	4PST (standard)	Screw mounting	Flat-bladed screw terminal	5 VDC 12 VDC 24 VDC	G6B-4FB1ND
	4PST (standard)	Screw mounting	Connector	5 VDC 12 VDC 24 VDC	G6B-4FPND

Note: 1. For replacement relays, use relays with the same voltage specifications as the relays provided with the Terminal when it was purchased. Longer operating life can be achieved by replacing the G6B-4□□ND with the G6B-1147P-FD-US.

2. Standard models are also available without relays mounted to the sockets. To obtain such terminals, replace the "G6B" portion of the model number with "P6BF." For example, to order G6B-4BND with empty sockets, use model number P6BF-4BND. Also specify voltage specifications for models with operation indicators.

Specifications

■ Ratings

Coil Ratings (per G6B Relay)

Rated voltage	5 VDC	12 VDC	24 VDC
Rated current	35.5 mA	19.1 mA	10.7 mA
Coil resistance	125 Ω	720 Ω	2,880 Ω
Must operate voltage	80% max. of rated voltage		
Must release voltage	10% min. of rated voltage		
Max. voltage	130% of rated voltage		
Power consumption	Approx. 200 mW		

- Note:**
1. Rated current and coil resistance were measured at a coil temperature of 23°C with a tolerance of ±20%.
 2. Operating characteristics were measured at a coil temperature of 23°C.
 3. The maximum allowable voltage is the maximum value of the allowable voltage range for the relay coil operating power supply. There is no continuous allowance.
 4. Diodes to absorb coil surge are equivalent to S5688J (reverse voltage resistance: 600 V; forward current: 1 A).

Contact Ratings

Classification	G6B-4BND (standard), G6B-47BND (long-life)		G6B-48BND (high-reliability)	
Load	Resistive load ($\cos\phi = 1$)	Inductive load ($\cos\phi = 0.4$, L/R = 7 ms)	Resistive load ($\cos\phi = 1$)	Inductive load ($\cos\phi = 0.4$, L/R = 7 ms)
Rated load	5 A at 250 VAC, 5 A at 30 VDC	2 A at 250 VAC, 2 A at 30 VDC	2 A at 250 VAC, 2 A at 30 VDC	0.5 A at 250 VAC, 0.5 A at 30 VDC
Rated carry current	5 A		2 A	
Max. switching voltage	380 VAC, 125 VDC			
Max. switching current	5 A		2 A	
Max. switching power	1,250 VA, 150 W	500 VA, 60 W	500 VA, 60 W	125 VA, 15 W
Error rate (reference value) (see note)	10 mA at 5 VDC		1 mA at 1 VDC	

Note: This value fulfills the P reference value of opening/closing at a rate of 120 times per min (ambient operating environment and determination criteria according to JIS C5442).

■ Characteristics

Contact resistance (see note 2)	100 mΩ max.
Operate time	10 ms max. (approx. 3 ms)
Release time	15 ms max. (approx. 4 ms)
Switching power	Mechanical: 18,000 operations/hr Rated load: 1,800 operations/hr
Insulation resistance	1,000 MΩ min. (at 500 VDC)
Dielectric strength	2,000 VAC, 50/60 Hz for 1 min between coil and contacts 2,000 VAC, 50/60 Hz for 1 min between contacts of different polarity 1,000 VAC, 50/60 Hz for 1 min between contacts of same polarity 250 VAC, 50/60 Hz for 1 min between coils of different polarity
Vibration resistance	Destruction: 10 to 55 to 10 Hz, 0.75-mm single amplitude (1.5-mm double amplitude) Malfunction: 10 to 55 to 10 Hz, 0.75-mm single amplitude (1.5-mm double amplitude)
Shock resistance	Destruction: 1,000 m/s ² (approx. 100G) Malfunction: 100 m/s ² (approx. 10G)
Endurance	Mechanical: 50,000,000 operations min. (at 18,000 operations/hr) Electrical: 100,000 operations min. (at 1,800 operations/hr, rated load) 500,000 operations min. for long-life at 2 A 100,000 operations min for long-life at 5 A
Ambient temperature	Operating: -25°C to 55°C (with no icing or condensation) Storage: -25°C to 55°C (with no icing or condensation)
Ambient humidity	Operating: 35% to 85%
Weight	Approx. 75 g

- Note:**
1. The above values are initial values.
 2. Measurement condition: 1 A at 5 VDC

Engineering Data

Maximum Switching Power

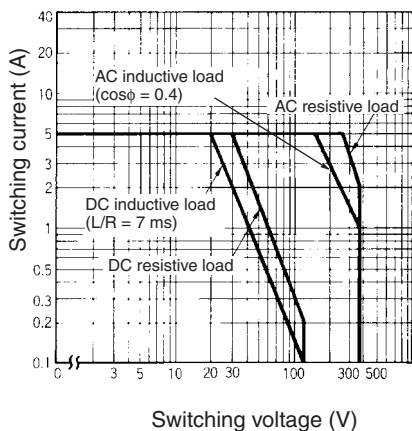

Endurance

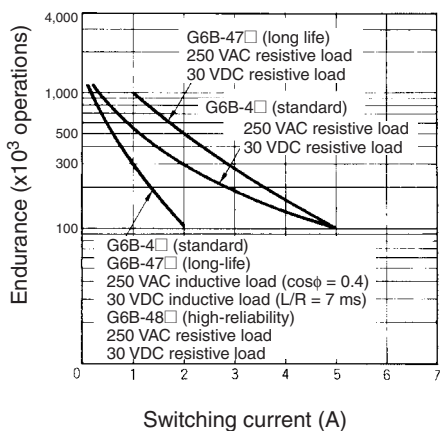

Contact Reliability (High-reliability Models)

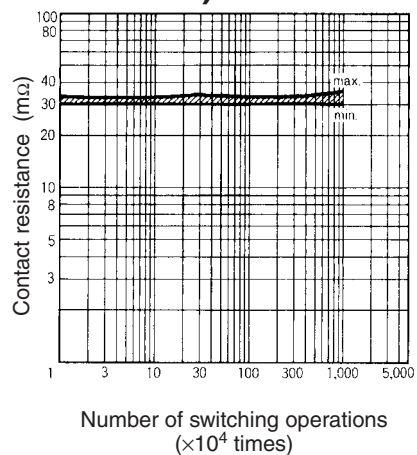

Dimensions

Note: All units are in millimeters unless otherwise indicated.

Philip Screw Terminals

G6B-4BND
G6B-47BND
G6B-48BND

Note: G6B-4BND is shown in illustration (terminal numbers are incised).

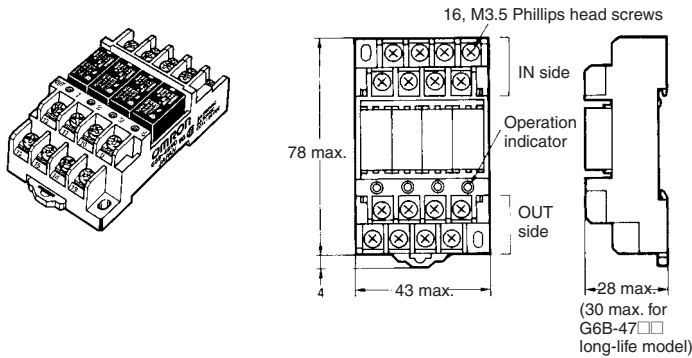

Mounting Holes

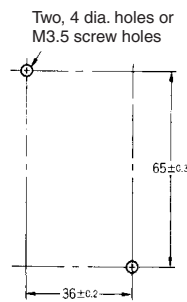

Terminal Arrangement/ Internal Connections (Top View)

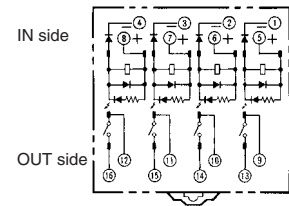

Note: Do not reverse the coil polarity.

Flat Screw Terminal

G6B-4FB1ND

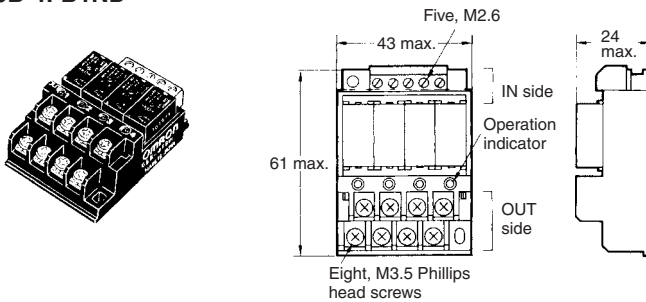

Mounting Holes

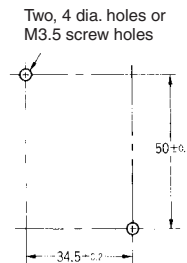

Terminal Arrangement/ Internal Connections (Top View)

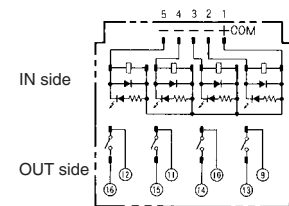

Note: Do not reverse the coil polarity.

Connector Terminal

G6B-4FPND

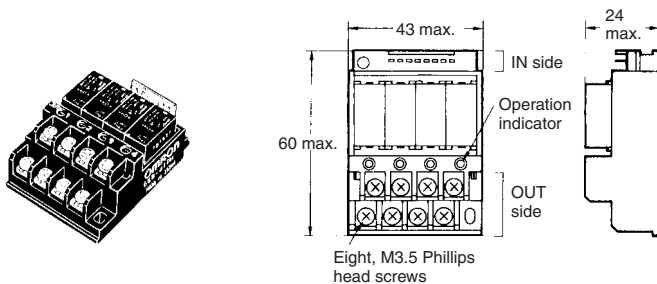

Mounting Holes

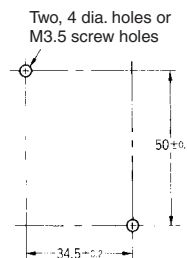

Terminal Arrangement/ Internal Connections (Top View)

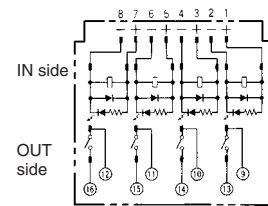

Note: Do not reverse the coil polarity.

■ Accessories (Order Separately)

Replacement Relays

Applicable terminal relay	Rated voltage	Model
G6B-4BND	5 VDC 12 VDC 24 VDC	G6B-1114P-FD-US
G6B-47BND	5 VDC 12 VDC 24 VDC	G6B-1174P-FD-US

Note: Relays cannot be replaced for G6B-48BND, which is mounted directly to boards.

Relay Mounting Products

Name	Model
Relay Removal Tool	P6B-Y1
Short Bars	G6B-4-SB
Mounting Track	PFP-100N
	PFP-50N
	PFP-100N2
End Plate	PFP-M
Spacer	PFP-S

P6B-Y1 Relay Removal Tool

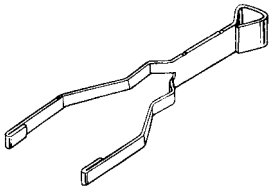

G6B-4-SB Short Bars

Short Bars are used to wire crossovers for common terminals for coils or contacts.

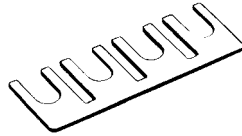

G6B-4-C Terminal Covers (Two per set)

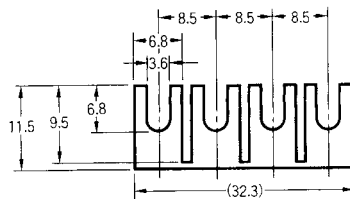
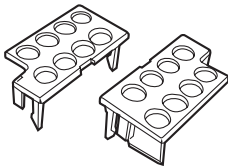

Precautions

Wiring

Be sure to turn OFF the power when wiring the Unit and do not touch the charged terminals of the Unit. Otherwise, an electric shock may result.

Do not apply overvoltage to the input terminals. Otherwise, the Unit may malfunction or burn.

Relay Models

Do not connect the Unit to loads exceeding the rated switching power (switching voltage or current). Otherwise, faulty insulation, contact weld, or faulty contact of Relays, or damage to Relays may result, or the Relays may malfunction or burn.

The life of Relays varies with the switching condition. Test the Relays under the actual operating conditions before using the Relays within the permissible switching frequency. The use of deteriorated Relays may result in the faulty insulation of the Relays or cause the Relays to burn.

Do not use the Unit in locations with inflammable gas. Otherwise, a fire or explosion due to the heat of the Relays or sparks from the Relays may result when they are switched.

Correct Use

Mounting

Heat generated by the relays must be considered when gang-mounting. Space must be provided between the relays or other methods must be taken to maintain the relays' ambient temperature at 55 °C or lower.

Replacement of Relays

G6B-4□□ND

Use the P6B-Y1 Removal Tool as shown in the following diagram.

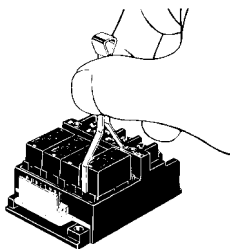

Be sure to turn OFF the power to the Unit before replacing a Relay. Relays must be inserted straight onto the socket connector pins to ensure proper connection.

G6B-48BND models (high reliability) are connected directly to boards to increase reliability and the relays are thus not replaceable. If relay replacement is necessary, use the P6BF-4BND Terminal Sockets together with the G6B-1184P Mini Relays. P6BF-4BND Terminal Sockets are equipped with relay replacement sockets.

Do not mount Relays that are different to one another in voltage.

Relays Mounted

G6B-4□□ND standard: G6B-1114P-FD-US
 G6B-4□□ND long life: G6B-1174P-FD
 G6B-4□□ND high reliability: G6B-1184P-US
 Replacement is not possible for G6B-48BND.

Wiring

Be sure to connect the input terminals with the correct polarity.

Coil Voltage

Be sure not to impose voltage exceeding the permissible voltage on the coil continuously.

Do not use the relays when other inductive loads are connected in parallel with the coil input or when there are surges during power supply because the built-in diodes used to absorb surge may be destroyed.

Do Not Use the Following Circuit

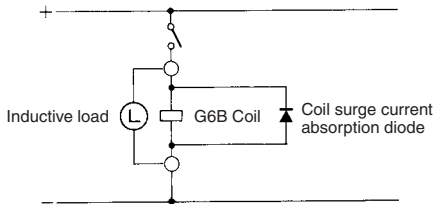

Handling

Do not drop, shock, or vibrate the Unit excessively. Otherwise, damage to the Unit may result or the Unit may malfunction. Make sure that all the Relays are properly mounted before use.

Screw Tightening Torque

Tighten each terminal screw to a torque of 0.78 to 1.18N·m.
 Tighten each mounting screw to a torque of 0.59 to 0.98 N·m.

Installation Environment

Do not install the Unit in the following locations. Otherwise, damage to the Unit may result or the Unit may malfunction.

- Locations with direct sunlight.
- Locations with an ambient temperature range not within 0°C to 55°C.
- Locations with rapid temperature changes resulting in condensation or locations with relative humidity ranges not within 10% to 90%.
- Locations with corrosive or inflammable gas.
- Locations with excessive dust, salinity, or metal powder.
- Locations with vibration or shock affecting the Unit.
- Locations with water, oil, or chemical sprayed on the Unit.

Disassembly, Repair, and Modification

Do not disassemble, repair, or modify the Unit. Otherwise, an electric shock may result or the Unit may malfunction.

ALL DIMENSIONS SHOWN ARE IN MILLIMETERS.
 To convert millimeters into inches, multiply by 0.03937. To convert grams into ounces, multiply by 0.03527.



Компания «ЭлектроПласт» предлагает заключение долгосрочных отношений при поставках импортных электронных компонентов на взаимовыгодных условиях!

Наши преимущества:

- Оперативные поставки широкого спектра электронных компонентов отечественного и импортного производства напрямую от производителей и с крупнейших мировых складов;
- Поставка более 17-ти миллионов наименований электронных компонентов;
- Поставка сложных, дефицитных, либо снятых с производства позиций;
- Оперативные сроки поставки под заказ (от 5 рабочих дней);
- Экспресс доставка в любую точку России;
- Техническая поддержка проекта, помощь в подборе аналогов, поставка прототипов;
- Система менеджмента качества сертифицирована по Международному стандарту ISO 9001;
- Лицензия ФСБ на осуществление работ с использованием сведений, составляющих государственную тайну;
- Поставка специализированных компонентов (Xilinx, Altera, Analog Devices, Intersil, Interpoint, Microsemi, Aeroflex, Peregrine, Syfer, Eurofarad, Texas Instrument, Miteq, Cobham, E2V, MA-COM, Hittite, Mini-Circuits, General Dynamics и др.);

Помимо этого, одним из направлений компании «ЭлектроПласт» является направление «Источники питания». Мы предлагаем Вам помощь Конструкторского отдела:

- Подбор оптимального решения, техническое обоснование при выборе компонента;
- Подбор аналогов;
- Консультации по применению компонента;
- Поставка образцов и прототипов;
- Техническая поддержка проекта;
- Защита от снятия компонента с производства.



Как с нами связаться

Телефон: 8 (812) 309 58 32 (многоканальный)

Факс: 8 (812) 320-02-42

Электронная почта: org@eplast1.ru

Адрес: 198099, г. Санкт-Петербург, ул. Калинина, дом 2, корпус 4, литера А.