



**TV-5/TV-8 rated
1 Form A 5A/8A silent type
power relays**

LK-Q RELAYS



RoHS compliant

Protective construction: Flux-resistant type

FEATURES

1. High sensitivity

A nominal operating power of 250mW and high sensitivity make it ideal for energy saving (LK relay is 530mW).

2. Silent

Approx. 10 dB less sound pressure than previous LK series relay

3. High inrush current capability

Switching capability;

- TV-5 type: inrush 100A, steady: 5A
- TV-8 type: inrush 118A, steady: 8A

4. Long insulation distance

- 1) Creepage distance and clearances between contact and coil: Min. 6 mm .236 inch (In compliance with IEC60065)
- 2) Surge withstand voltage between contact and coil: 10,000 V

5. Conforms to the various safety standards

UL/C-UL, TÜV, and SEMKO approved

TYPICAL APPLICATIONS

- Flat-panel TVs
- Audio visual equipment

ORDERING INFORMATION

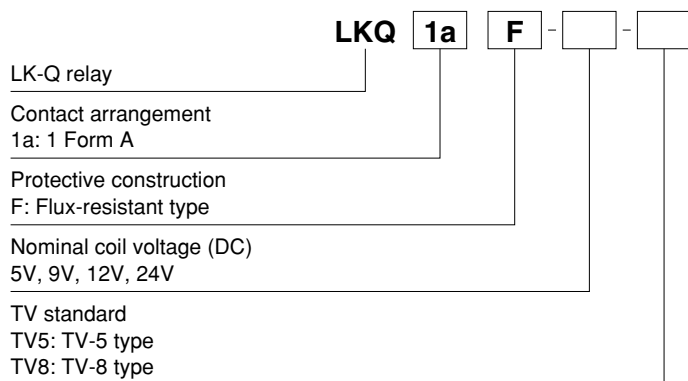

Note: Certified by UL/C-UL, TÜV and SEMKO

TYPES

Contact arrangement	Nominal coil voltage	Part No.	
		TV-5 type	TV-8 type
1 Form A	5V DC	LKQ1aF-5V-TV5	LKQ1aF-5V-TV8
	9V DC	LKQ1aF-9V-TV5	LKQ1aF-9V-TV8
	12V DC	LKQ1aF-12V-TV5	LKQ1aF-12V-TV8
	24V DC	LKQ1aF-24V-TV5	LKQ1aF-24V-TV8

Standard packing Carton: 100 pcs. Case: 500 pcs.

RATING

1. Coil data

Nominal coil voltage	Pick-up voltage (at 20°C 68°F)	Drop-out voltage (at 20°C 68°F)	Nominal operating current [±10%] (at 20°C 68°F)	Coil resistance [±10%] (at 20°C 68°F)	Nominal operating power	Max. applied voltage (at 20°C 68°F)
5V DC	80%V or less of nominal voltage (Initial)	10%V or more of nominal voltage (Initial)	50mA	100Ω	250mW	6.5V DC
9V DC			27.8mA	324Ω		11.7V DC
12V DC			20.8mA	576Ω		15.6V DC
24V DC			10.4mA	2,304Ω		31.2V DC

2. Specifications

Characteristics	Item	Specifications	
		TV-5 type	TV-8 type
Contact	Arrangement	1 Form A	
	Contact resistance (Initial)	Max. 100 mΩ (By voltage drop 6 V DC 1A)	
	Contact material	AgSnO ₂ type	
Rating	Nominal switching capacity (resistive load)	5A 277V AC	8A 277V AC
	Max. switching power (resistive load)	1,385VA	2,216VA
	Max. switching voltage	277V AC	
	Max. switching current	5A (AC)	8A (AC)
	Min. switching capacity (reference value)*1	100mA, 5V DC	
Electrical characteristics	Insulation resistance (Initial)	Min. 1,000MΩ (at 500V DC) Measurement at same location as "Breakdown voltage" section.	
	Breakdown voltage (Initial)	Between open contacts	1,000 Vrms for 1 min. (Detection current: 10 mA)
		Between contact and coil	4,000 Vrms for 1 min. (Detection current: 10 mA)
	Surge breakdown voltage*2 (Between contact and coil) (Initial)	10,000 V	
	Operate time (at nominal voltage) (at 20°C 68°F) (Initial)	Max. 15 ms (excluding contact bounce time.)	
Release time (at nominal voltage) (at 20°C 68°F) (Initial)	Max. 5 ms (excluding contact bounce time) (Without diode)		
Mechanical characteristics	Shock resistance	Functional	200 m/s ² (Half-wave pulse of sine wave: 11 ms; detection time: 10μs.)
		Destructive	1,000 m/s ² (Half-wave pulse of sine wave: 6 ms.)
	Vibration resistance	Functional	10 to 55 Hz at double amplitude of 1.5 mm (Detection time: 10μs.)
		Destructive	10 to 55 Hz at double amplitude of 1.5 mm
Expected life	Mechanical (at 180 times/min.)	Min. 10 ⁶	
	Electrical	Min. 10 ⁵ (ON: 1.5s, OFF: 1.5s, at nominal switching capacity)	Min. 5×10 ⁴ (ON: 1.5s, OFF: 1.5s, at nominal switching capacity)
Conditions	Conditions for operation, transport and storage*3	Ambient temperature: -40°C to +70°C -40°F to +158°F, Humidity: 5 to 85% R.H. (Not freezing and condensing at low temperature), Air pressure: 86 to 106kPa	
	Max. operating speed	20 times/min. (at nominal switching capacity)	
Unit weight		Approx. 12 g .42 oz	

Notes: *1. This value can change due to the switching frequency, environmental conditions, and desired reliability level, therefore it is recommended to check this with the actual load.

*2. Wave is standard shock voltage of ±1.2×50μs according to JEC-212-1981

*3. The upper limit of the ambient temperature is the maximum temperature that can satisfy the coil temperature rise value. Refer to Usage, transport and storage conditions in NOTES.

REFERENCE DATA

1. Max. switching power (AC resistive load)

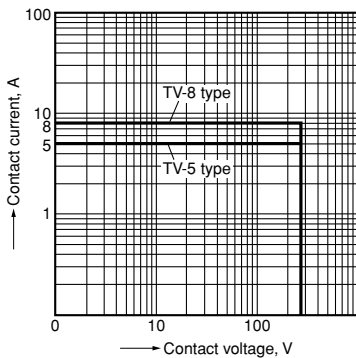

2-(1). Coil temperature rise (TV-5 type)

Sample: LKQ1aF-12V-TV5, 6 pcs.
Point measured: coil inside
Contact current: 0A, 5A

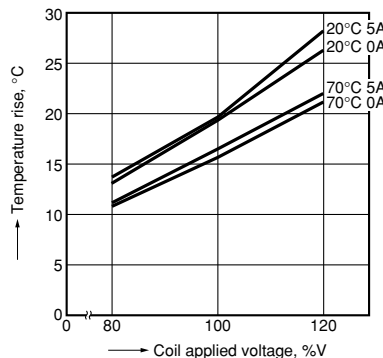

2-(2). Coil temperature rise (TV-8 type)

Sample: LKQ1aF-12V-TV8, 6 pcs.
Point measured: coil inside
Contact current: 0A, 8A

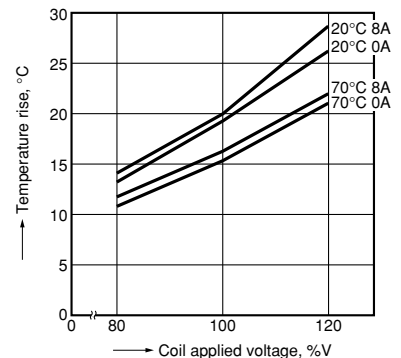

3-(1). Ambient temperature characteristics and coil applied voltage (TV-5 type)

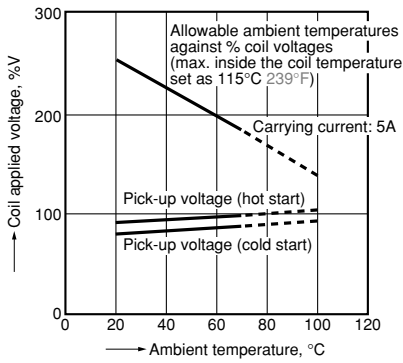

3-(2). Ambient temperature characteristics and coil applied voltage (TV-8 type)

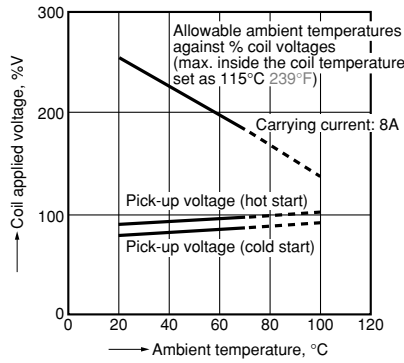

4-(1). Electrical life test (TV-5 type)

(5A 277V AC, resistive load)

Sample: LKQ1aF-12V-TV5, 6 pcs.
Operation frequency: 20 times/min.
(ON/OFF = 1.5s: 1.5s)
Ambient temperature: 20°C 68°F

Circuit:

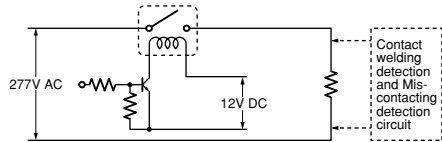

Change of pick-up and drop-out voltage

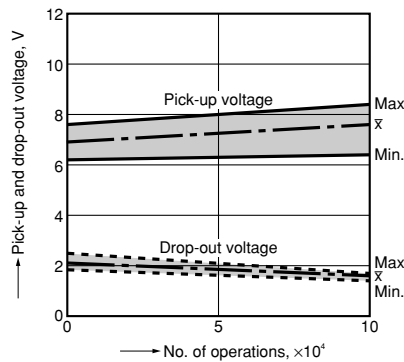

Change of contact resistance

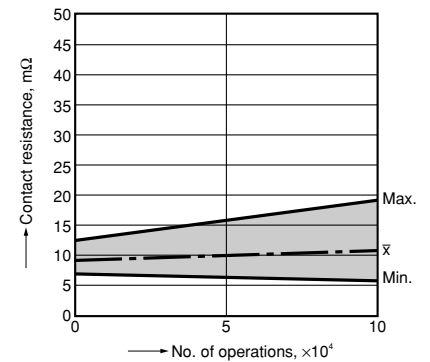

4-(2). Electrical life test (TV-8 type)

(8A 277V AC, resistive load)

Sample: LKQ1aF-12V-TV8, 6 pcs.
Operation frequency: 20 times/min.
(ON/OFF = 1.5s: 1.5s)
Ambient temperature: 20°C 68°F

Circuit:

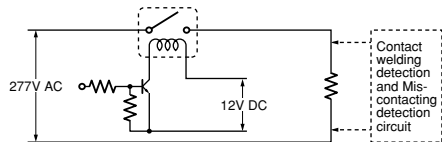

Change of pick-up and drop-out voltage

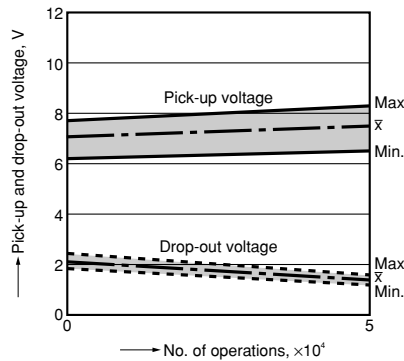

Change of contact resistance

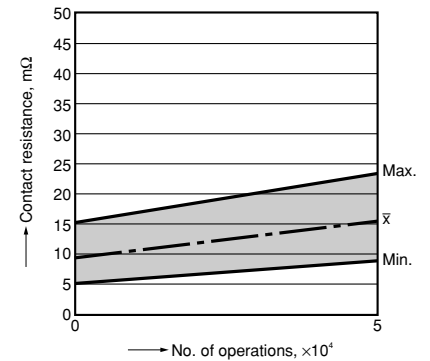

5-(1). Operation noise distribution

Measuring conditions
Sample: LKQ1aF-12V-TV5, 50pcs
Background noise: approx. 20dB
Coil voltage: 12V DC
Equipment setting: "A" weighted
Single part (refer to figure below)
With diode

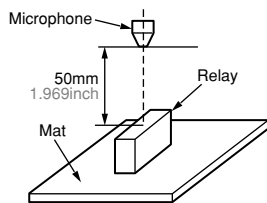

When operate (At contact making)

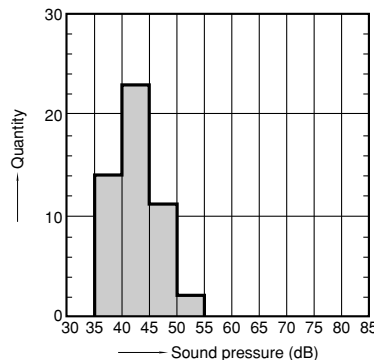

When release (At contact breaking)

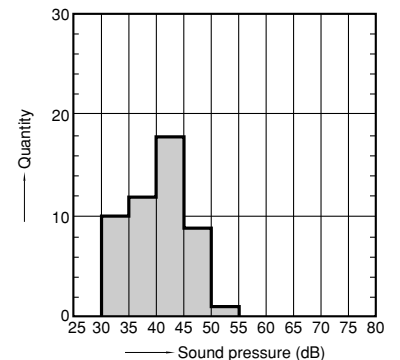

5-(2). Operation noise distribution
(refer to comparison)

Measuring conditions
Sample: LKT1aF-12V, 50pcs
Background noise: approx. 20dB
Coil voltage: 12V DC
Equipment setting: "A" weighted
Single part (refer to figure below)
With diode

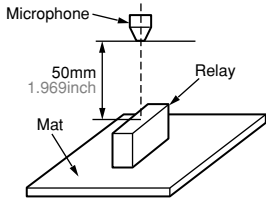

When operate

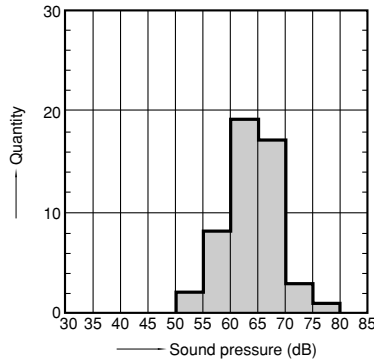

When release

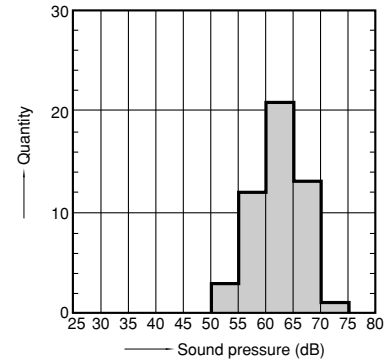

DIMENSIONS (mm inch)

The CAD data of the products with a **CAD Data** mark can be downloaded from: <http://industrial.panasonic.com/ac/e/>

CAD Data

External dimensions

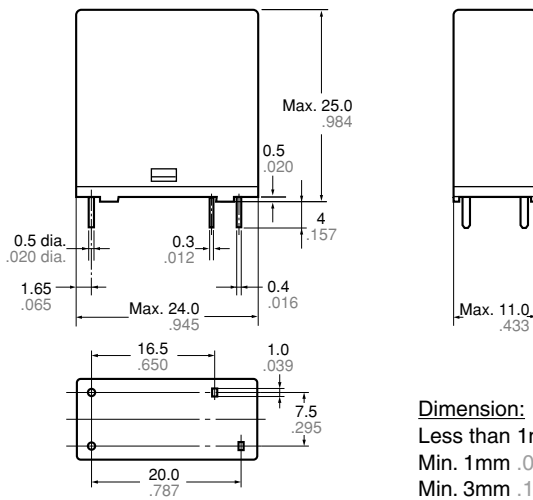

PC board pattern (Bottom view)

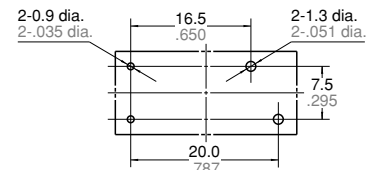

Tolerance: $\pm 0.1 \pm 0.004$

Schematic (Bottom view)



Dimension:

Less than 1mm .039inch:
Min. 1mm .039inch less than 3mm .118 inch: $\pm 0.2 \pm 0.008$
Min. 3mm .118 inch:

General tolerance

$\pm 0.1 \pm 0.004$
 $\pm 0.2 \pm 0.008$
 $\pm 0.3 \pm 0.012$

SAFETY STANDARDS

Item	UL/C-UL (Recognized)			TÜV (Certified)			SEMKO (Certified)		TV rating (UL/C-UL)	
	File No.	Contact rating	Cycles	File No.	Contact rating	Cycles	File No.	Contact rating	File No.	Contact rating
TV-5 type	E43149	10A 277V AC General use	5x10 ⁴	B 12 09 13461 333	5A 250V AC (cosφ=1.0)	10 ⁵	1408509	3A/100A 250V AC	E43149	TV-5
		5A 277V AC General use	10 ⁵							
		5A 30V DC Resistive	10 ⁵							
TV-8 type	E43149	10A 277V AC General use	5x10 ⁴	B 12 09 13461 333	8A 250V AC (cosφ=1.0)	2x10 ⁴	1408509	3/100A 250V AC	E43149	TV-8
		8A 277V AC General use	5x10 ⁴							
		5A 277V AC General use	10 ⁵							
		5A 30V DC Resistive	10 ⁵							

* CSA standard: Certified by C-UL

NOTES

1. For cautions for use, please read
"GENERAL APPLICATION
GUIDELINES".

Please contact

Panasonic Corporation

Electromechanical Control Business Division

■ 1006, Oaza Kadoma, Kadoma-shi, Osaka 571-8506, Japan
industrial.panasonic.com/ac/e/

Panasonic[®]

©Panasonic Corporation 2016

Mouser Electronics

Authorized Distributor

Click to View Pricing, Inventory, Delivery & Lifecycle Information:

Panasonic:

[LKQ1AF-12V-TV-5](#) [LKQ1AF-12V-TV-8](#) [LKQ1AF-12V-TV8-Y2](#) [LKQ1AF-24V-TV-5](#) [LKQ1AF-24V-TV-8](#) [LKQ1AF-5V-TV-5](#) [LKQ1AF-5V-TV-8](#) [LKQ1AF-9V-TV-5](#) [LKQ1AF-9V-TV-8](#) [LKQ1AF-5V-TV8-Y2](#)



Компания «ЭлектроПласт» предлагает заключение долгосрочных отношений при поставках импортных электронных компонентов на взаимовыгодных условиях!

Наши преимущества:

- Оперативные поставки широкого спектра электронных компонентов отечественного и импортного производства напрямую от производителей и с крупнейших мировых складов;
- Поставка более 17-ти миллионов наименований электронных компонентов;
- Поставка сложных, дефицитных, либо снятых с производства позиций;
- Оперативные сроки поставки под заказ (от 5 рабочих дней);
- Экспресс доставка в любую точку России;
- Техническая поддержка проекта, помощь в подборе аналогов, поставка прототипов;
- Система менеджмента качества сертифицирована по Международному стандарту ISO 9001;
- Лицензия ФСБ на осуществление работ с использованием сведений, составляющих государственную тайну;
- Поставка специализированных компонентов (Xilinx, Altera, Analog Devices, Intersil, Interpoint, Microsemi, Aeroflex, Peregrine, Syfer, Eurofarad, Texas Instrument, Miteq, Cobham, E2V, MA-COM, Hittite, Mini-Circuits, General Dynamics и др.);

Помимо этого, одним из направлений компании «ЭлектроПласт» является направление «Источники питания». Мы предлагаем Вам помощь Конструкторского отдела:

- Подбор оптимального решения, техническое обоснование при выборе компонента;
- Подбор аналогов;
- Консультации по применению компонента;
- Поставка образцов и прототипов;
- Техническая поддержка проекта;
- Защита от снятия компонента с производства.



Как с нами связаться

Телефон: 8 (812) 309 58 32 (многоканальный)

Факс: 8 (812) 320-02-42

Электронная почта: org@eplast1.ru

Адрес: 198099, г. Санкт-Петербург, ул. Калинина, дом 2, корпус 4, литера А.