

Octal I²C 16-/12-Bit Rail-to-Rail DACs with 10ppm/°C Max Reference

DESCRIPTION

FEATURES

- Integrated Reference 10ppm/°C Max
- Maximum INL Error: ±4LSB
- Guaranteed Monotonic Over Temperature
- Selectable Internal or External Reference
- 2.7V to 5.5V Supply Range (LTC2657-L)
- Integrated Reference Buffers
- Ultralow Crosstalk between DACs(0.8nV•s)
- Power-On-Reset to Zero-Scale/Mid-Scale
- 400kHz I²C Interface
- Tiny 20-Lead 4mm × 5mm QFN and 20-Lead Thermally enhanced TSSOP packages

APPLICATIONS

- Mobile Communications
- Process Control and Industrial Automation
- Instrumentation
- Automatic Test Equipment
- Automotive

The LTC[®]2657 is a family of octal I²C 16-/12-Bit Rail-to-Rail DACs with Integrated 10ppm/°C Max Reference. The DACs have built-in high performance, rail-to-rail, output buffers and are guaranteed monotonic. The LTC2657-L has a full-scale output of 2.5V with the integrated reference and operates from a single 2.7V to 5.5V supply. The LTC2657-H has a full-scale output of 4.096V with the integrated reference and operates from a 4.5V to 5.5V supply. Each DAC can also operate with an external reference, which sets the full-scale output to 2 times the external reference voltage.

The parts use a 2-wire I²C compatible serial interface. The LTC2657 operates in both the standard mode (maximum clock rate of 100kHz) and the fast mode (maximum clock rate of 400kHz). The LTC2657 incorporates a power-on reset circuit that is controlled by the PORSEL pin. If PORSEL is tied to GND the DACs reset to zero-scale at power-up. If PORSEL is tied to V_{CC}, the DACs reset to mid-scale at power-up.

LT, LT, LTC and LTM are registered trademarks of Linear Technology Corporation. All other trademarks are the property of their respective owners. Protected by U.S. Patents including 5396245, 6891433 and patent pending.

BLOCK DIAGRAM

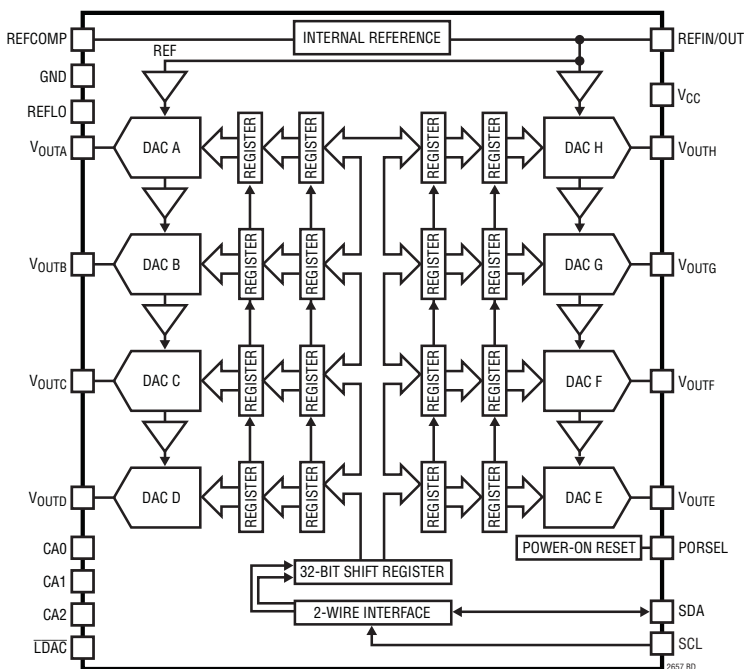

INL vs Code (LTC2657-16)

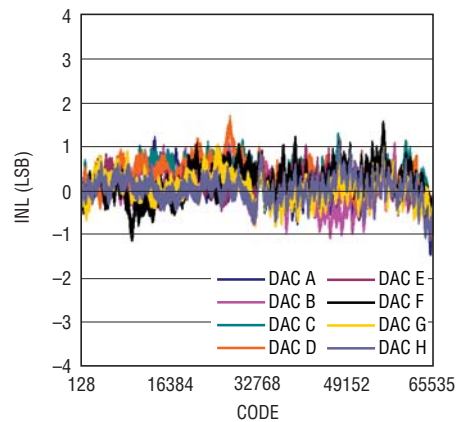

2657 TA01

ABSOLUTE MAXIMUM RATINGS

(Notes 1, 2)

Supply Voltage (V_{CC}) -0.3V to 6V
 SCL, SDA, \overline{LDAC} , REFLO..... -0.3V to 6V
 V_{OUTA} to V_{OUTH} -0.3V to $\text{Min}(V_{CC} + 0.3V, 6V)$
 REFIN/OUT, REFCOMP -0.3V to $\text{Min}(V_{CC} + 0.3V, 6V)$
 PORSEL, CA0, CA1, CA2... -0.3V to $\text{Min}(V_{CC} + 0.3V, 6V)$

Operating Temperature Range
 LTC2657C 0°C to 70°C
 LTC2657I..... -40°C to 85°C
 Maximum Junction Temperature..... 150°C
 Storage Temperature Range..... -65 to 150°C
 Lead Temperature (Soldering FE-Package, 10 sec).. 300°C

PIN CONFIGURATION

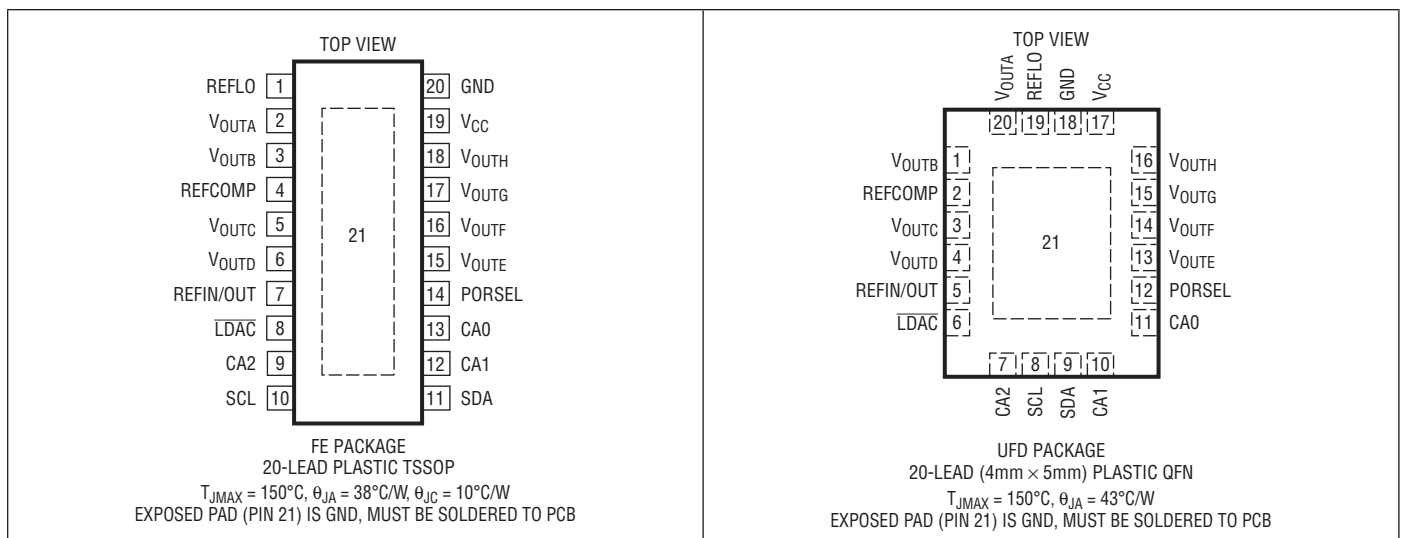

PRODUCT SELECTOR GUIDE

LTC2657 B C UFD -L 16 #TR PBF

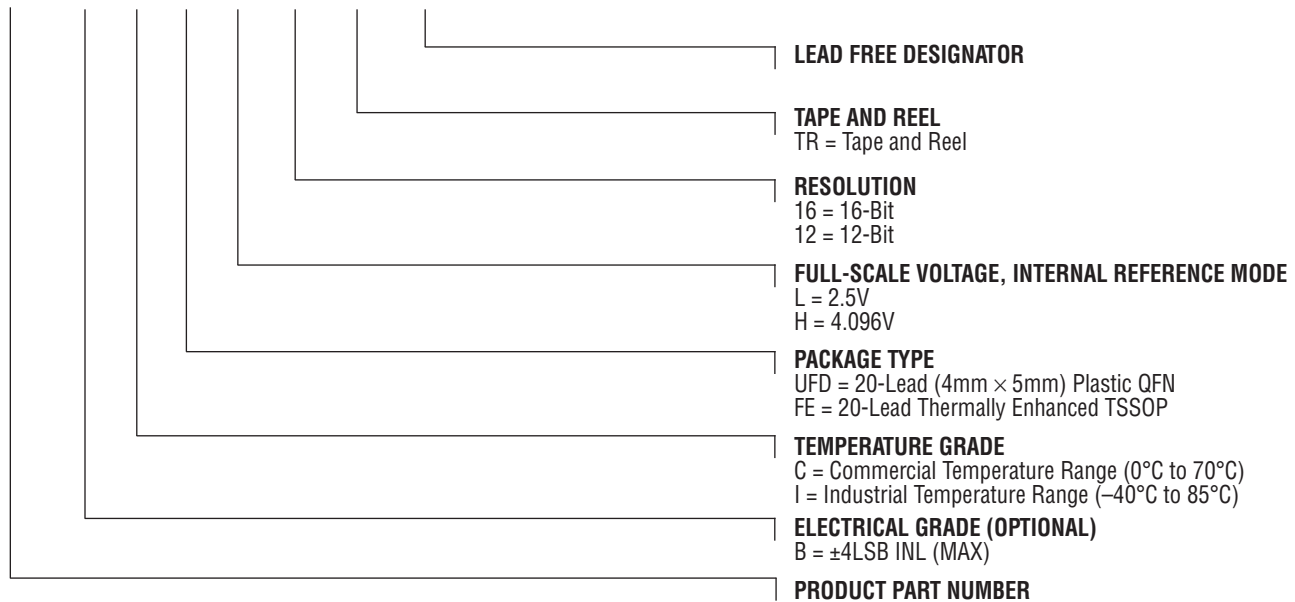

Consult LTC Marketing for information on non-standard lead based finish parts.

For more information on lead free part marking, go to: <http://www.linear.com/leadfree/>

For more information on tape and reel specifications, go to: <http://www.linear.com/tapeandreel/>

ORDER INFORMATION

LEAD FREE FINISH	TAPE AND REEL	PART MARKING*	PACKAGE DESCRIPTION	TEMPERATURE RANGE	MAXIMUM INL
LTC2657BCFE-L16#PBF	LTC2657BCFE-L16#TRPBF	LTC2657FE-L16	20-Lead Thermally Enhanced TSSOP	0°C to 70°C	±4
LTC2657BIFE-L16#PBF	LTC2657BIFE-L16#TRPBF	LTC2657FE-L16	20-Lead Thermally Enhanced TSSOP	-40°C to 85°C	±4
LTC2657BCUFD-L16#PBF	LTC2657BCUFD-L16#TRPBF	57L16	20-Lead (4mm × 5mm) Plastic QFN	0°C to 70°C	±4
LTC2657BIUFD-L16#PBF	LTC2657BIUFD-L16#TRPBF	57L16	20-Lead (4mm × 5mm) Plastic QFN	-40°C to 85°C	±4
LTC2657BCFE-H16#PBF	LTC2657BCFE-H16#TRPBF	LTC2657FE-H16	20-Lead Thermally Enhanced TSSOP	0°C to 70°C	±4
LTC2657BIFE-H16#PBF	LTC2657BIFE-H16#TRPBF	LTC2657FE-H16	20-Lead Thermally Enhanced TSSOP	-40°C to 85°C	±4
LTC2657BCUFD-H16#PBF	LTC2657BCUFD-H16#TRPBF	57H16	20-Lead (4mm × 5mm) Plastic QFN	0°C to 70°C	±4
LTC2657BIUFD-H16#PBF	LTC2657BIUFD-H16#TRPBF	57H16	20-Lead (4mm × 5mm) Plastic QFN	-40°C to 85°C	±4
LTC2657CFE-L12#PBF	LTC2657CFE-L12#TRPBF	LTC2657FE-L12	20-Lead Thermally Enhanced TSSOP	0°C to 70°C	±1
LTC2657IFE-L12#PBF	LTC2657IFE-L12#TRPBF	LTC2657FE-L12	20-Lead Thermally Enhanced TSSOP	-40°C to 85°C	±1
LTC2657CUFD-L12#PBF	LTC2657CUFD-L12#TRPBF	57L12	20-Lead (4mm × 5mm) Plastic QFN	0°C to 70°C	±1
LTC2657IUFD-L12#PBF	LTC2657IUFD-L12#TRPBF	57L12	20-Lead (4mm × 5mm) Plastic QFN	-40°C to 85°C	±1
LTC2657CFE-H12#PBF	LTC2657CFE-H12#TRPBF	LTC2657FE-H12	20-Lead Thermally Enhanced TSSOP	0°C to 70°C	±1
LTC2657IFE-H12#PBF	LTC2657IFE-H12#TRPBF	LTC2657FE-H12	20-Lead Thermally Enhanced TSSOP	-40°C to 85°C	±1
LTC2657CUFD-H12#PBF	LTC2657CUFD-H12#TRPBF	57H12	20-Lead (4mm × 5mm) Plastic QFN	0°C to 70°C	±1
LTC2657IUFD-H12#PBF	LTC2657IUFD-H12#TRPBF	57H12	20-Lead (4mm × 5mm) Plastic QFN	-40°C to 85°C	±1

Consult LTC Marketing for parts specified with wider operating temperature ranges. *The temperature grade is identified by a label on the shipping container. Consult LTC Marketing for information on non-standard lead based finish parts.

For more information on lead free part marking, go to: <http://www.linear.com/leadfree/>

For more information on tape and reel specifications, go to: <http://www.linear.com/tapeandreeel/>

ELECTRICAL CHARACTERISTICS

The ● denotes the specifications which apply over the full operating temperature range, otherwise specifications are at $T_A = 25^\circ\text{C}$. $V_{CC} = 2.7\text{V}$ to 5.5V , V_{OUT} unloaded unless otherwise specified.
LTC2657B-L16/LTC2657-L12 (Internal Reference = 1.25V)

SYMBOL	PARAMETER	CONDITIONS	LTC2657-12			LTC2657B-16			UNITS
			MIN	TYP	MAX	MIN	TYP	MAX	
DC Performance									
	Resolution		●	12			16		Bits
	Monotonicity	(Note 3)	●	12			16		Bits
DNL	Differential Nonlinearity	(Note 3)	●	±0.1	±0.5		±0.3	±1	LSB
INL	Integral Nonlinearity (Note 3)	$V_{CC} = 5.5\text{V}$, $V_{REF} = 2.5\text{V}$	●	±0.5	±1		±2	±4	LSB
	Load Regulation	$V_{CC} = 5\text{V} \pm 10\%$, Internal Reference, Mid-Scale, $-15\text{mA} \leq I_{OUT} \leq 15\text{mA}$	●	0.04	0.125		0.6	2	LSB/mA
		$V_{CC} = 3\text{V} \pm 10\%$, Internal Reference, Mid-Scale, $-7.5\text{mA} \leq I_{OUT} \leq 7.5\text{mA}$	●	0.06	0.25		1	4	LSB/mA
ZSE	Zero-Scale Error		●	1	3		1	3	mV
V_{OS}	Offset Error	(Note 4) $V_{REF} = 1.25\text{V}$	●	±1	±2		±1	±2	mV
	V_{OS} Temperature Coefficient			2			2		$\mu\text{V}/^\circ\text{C}$
GE	Gain Error		●	±0.02	±0.1		±0.02	±0.1	%FSR
	Gain Temperature Coefficient			1			1		ppm/ $^\circ\text{C}$

ELECTRICAL CHARACTERISTICS

The ● denotes the specifications which apply over the full operating temperature range, otherwise specifications are at $T_A = 25^\circ\text{C}$. $V_{CC} = 2.7\text{V}$ to 5.5V , V_{OUT} unloaded unless otherwise specified.
LTC2657B-L16/LTC2657-L12 (Internal Reference = 1.25V)

SYMBOL	PARAMETER	CONDITIONS	MIN	TYP	MAX	UNITS
V_{OUT}	DAC Output Span	Internal Reference		0 to 2.5		V
		External Reference = V_{EXTREF}		0 to $2 \cdot V_{EXTREF}$		V
PSR	Power Supply Rejection	$V_{CC} \pm 10\%$		-80		dB
R_{OUT}	DC Output Impedance	$V_{CC} = 5\text{V} \pm 10\%$, Internal Reference, Mid-Scale, $-15\text{mA} \leq I_{OUT} \leq 15\text{mA}$	●	0.04	0.15	Ω
		$V_{CC} = 3\text{V} \pm 10\%$, Internal Reference, Mid-Scale, $-7.5\text{mA} \leq I_{OUT} \leq 7.5\text{mA}$	●	0.04	0.15	Ω
	DC Crosstalk (Note 5)	Due to Full-Scale Output Change Due to Load Current Change Due to Powering Down (per Channel)		± 1.5 ± 2 ± 1		μV $\mu\text{V}/\text{mA}$ μV
I_{SC}	Short-Circuit Output Current (Note 6)	$V_{CC} = 5.5\text{V}$, $V_{EXTREF} = 2.8\text{V}$ Code: Zero-Scale, Forcing Output to V_{CC} Code: Full-Scale, Forcing Output to GND	●	20	65	mA
			●	20	65	mA
		$V_{CC} = 2.7\text{V}$, $V_{EXTREF} = 1.4\text{V}$ Code: Zero-Scale, Forcing Output to V_{CC} Code: Full-Scale, Forcing Output to GND	●	10	40	mA
			●	10	40	mA

Reference

	Reference Output Voltage			1.248	1.25	1.252	V
	Reference Temperature Coefficient	(Note 7) C-Grade Only			± 2	± 10	ppm/ $^\circ\text{C}$
	Reference Line Regulation	$V_{CC} \pm 10\%$			-80		dB
	Reference Short-Circuit Current	$V_{CC} = 5.5\text{V}$, Forcing REFIN/OUT to GND	●			5	mA
	REFCOMP Pin Short-Circuit Current	$V_{CC} = 5.5\text{V}$, Forcing REFCOMP to GND	●			200	μA
	Reference Load Regulation	$V_{CC} = 3\text{V} \pm 10\%$ or $5\text{V} \pm 10\%$, $I_{OUT} = 100\mu\text{A}$ Sourcing			40		mV/mA
	Reference Output Voltage Noise Density	$C_{REFCOMP} = C_{REFIN/OUT} = 0.1\mu\text{F}$ at $f = 1\text{kHz}$			30		nV/ $\sqrt{\text{Hz}}$
	Reference Input Range	External Reference Mode (Note 14)	●	0.5		$V_{CC}/2$	V
	Reference Input Current		●		0.001	1	μA
	Reference Input Capacitance	(Note 9)			40		pF

Power Supply

V_{CC}	Positive Supply Voltage	For Specified Performance	●	2.7		5.5	V
I_{CC}	Supply Current (Note 8)	$V_{CC} = 5\text{V}$, Internal Reference On	●		3.1	4.25	mA
		$V_{CC} = 5\text{V}$, Internal Reference Off	●		2.7	3.7	mA
		$V_{CC} = 3\text{V}$, Internal Reference On	●		3	3.8	mA
		$V_{CC} = 3\text{V}$, Internal Reference Off	●		2.6	3.2	mA
I_{SD}	Supply Current in Shutdown Mode (Note 8)	$V_{CC} = 5\text{V}$	●			3	μA

Digital I/O

V_{IL}	Low Level Input Voltage (SDA and SCL)		●			$0.3V_{CC}$	V
V_{IH}	High Level Input Voltage (SDA and SCL)		●	$0.7V_{CC}$			V
$V_{IL(LDAC)}$	Low Level Input Voltage (LDAC)	$V_{CC} = 4.5\text{V}$ to 5.5V	●			0.8	V
		$V_{CC} = 2.7\text{V}$ to 4.5V	●			0.6	V
$V_{IH(LDAC)}$	High Level Input Voltage (LDAC)	$V_{CC} = 3.6\text{V}$ to 5.5V	●	2.4			V
		$V_{CC} = 2.7\text{V}$ to 3.6V	●	2			V

ELECTRICAL CHARACTERISTICS

The ● denotes the specifications which apply over the full operating temperature range, otherwise specifications are at $T_A = 25^\circ\text{C}$. $V_{CC} = 2.7\text{V}$ to 5.5V , V_{OUT} unloaded unless otherwise specified. LTC2657B-L16/LTC2657-L12 (Internal Reference = 1.25V)

SYMBOL	PARAMETER	CONDITIONS				UNITS
			MIN	TYP	MAX	
$V_{IL(CA)}$	Low Level Input Voltage (CA0 and CA2)	See Test Circuit 1	●		0.15 V_{CC}	V
$V_{IH(CA)}$	High Level Input Voltage (CA0 and CA2)	See Test Circuit 1	●	0.85 V_{CC}		V
R_{INH}	Resistance from CA_n (n = 0, 1, 2) to V_{CC} to Set $CA_n = V_{CC}$	See Test Circuit 2	●		10	k Ω
R_{INL}	Resistance from CA_n (n = 0, 1, 2) to GND to Set $CA_n = \text{GND}$	See Test Circuit 2	●		10	k Ω
R_{INF}	Resistance from CA_n (n = 0, 1, 2) to V_{CC} or GND to Set $CA_n = \text{FLOAT}$	See Test Circuit 2	●	2		M Ω
V_{OL}	Low Level Output Voltage	Sink Current = 3mA	●	0	0.4	V
t_{OF}	Output Fall Time	$V_O = V_{IH(MIN)}$ to $V_O = V_{IL(MAX)}$, $C_B = 10\text{pF}$ to 400pF (Note 13)	●	20+0.1 C_B	250	ns
t_{SP}	Pulse Width of Spikes Suppressed by Input Filter		●	0	50	ns
I_{IN}	Input Leakage	$0.1V_{CC} \leq V_{IN} \leq 0.9V_{CC}$	●		1	μA
C_{IN}	I/O Pin Capacitance	(Note 9)	●		10	pF
C_B	Capacitance Load for Each Bus Line		●		400	pF
C_{CA_n}	External Capacitive Load on Address Pins CA0, CA1 and CA2		●		10	pF

The ● denotes the specifications which apply over the full operating temperature range, otherwise specifications are at $T_A = 25^\circ\text{C}$. $V_{CC} = 4.5\text{V}$ to 5.5V , V_{OUT} unloaded unless otherwise specified. LTC2657B-H16/LTC2657-H12 (Internal Reference = 2.048V)

SYMBOL	PARAMETER	CONDITIONS	LTC2657-12			LTC2657B-16			UNITS
			MIN	TYP	MAX	MIN	TYP	MAX	
DC Performance									
	Resolution		●	12			16		Bits
	Monotonicity	(Note 3)	●	12			16		Bits
DNL	Differential Nonlinearity	(Note 3)	●	± 0.1	± 0.5		± 0.3	± 1	LSB
INL	Integral Nonlinearity (Note 3)	$V_{CC} = 5.5\text{V}$, $V_{REF} = 2.5\text{V}$	●	± 0.5	± 1		± 2	± 4	LSB
	Load Regulation	$V_{CC} = 5\text{V} \pm 10\%$, Internal Reference, Mid-Scale, $-15\text{mA} \leq I_{OUT} \leq 15\text{mA}$	●	0.04	0.125		0.6	2	LSB/mA
ZSE	Zero-Scale Error		●	1	3		1	3	mV
V_{OS}	Offset Error	(Note 4) $V_{REF} = 2.048\text{V}$	●	± 1	± 2		± 1	± 2	mV
	V_{OS} Temperature Coefficient			2			2		$\mu\text{V}/^\circ\text{C}$
GE	Gain Error		●	± 0.02	± 0.1		± 0.02	± 0.1	%FSR
	Gain Temperature Coefficient			1			1		ppm/ $^\circ\text{C}$

ELECTRICAL CHARACTERISTICS

The ● denotes the specifications which apply over the full operating temperature range, otherwise specifications are at $T_A = 25^\circ\text{C}$. $V_{CC} = 4.5\text{V}$ to 5.5V , V_{OUT} unloaded unless otherwise specified.
LTC2657B-H16/LTC2657-H12 (Internal Reference = 2.048V)

SYMBOL	PARAMETER	CONDITIONS	MIN	TYP	MAX	UNITS
V_{OUT}	DAC Output Span	Internal Reference External Reference = V_{EXTREF}		0 to 4.096 0 to $2 \cdot V_{EXTREF}$		V V
PSR	Power Supply Rejection	$V_{CC} \pm 10\%$		-80		dB
R_{OUT}	DC Output Impedance	$V_{CC} = 5\text{V} \pm 10\%$, Internal Reference, Mid-Scale, $-15\text{mA} \leq I_{OUT} \leq 15\text{mA}$	●	0.04	0.15	Ω
	DC Crosstalk	Due to Full-Scale Output Change Due to Load Current Change Due to Powering Down (per Channel)		± 1.5 ± 2 ± 1		μV $\mu\text{V}/\text{mA}$ μV
I_{SC}	Short-Circuit Output Current (Note 4)	$V_{CC} = 5.5\text{V}$, $V_{EXTREF} = 2.8\text{V}$ Code: Zero-Scale, Forcing Output to V_{CC} Code: Full-Scale, Forcing Output to GND	● ●	20 20	65 65	mA mA

Reference

	Reference Output Voltage			2.044	2.048	2.052	V
	Reference Temperature Coefficient	(Note 7) C-Grade Only			± 2	± 10	ppm/ $^\circ\text{C}$
	Reference Line Regulation	$V_{CC} \pm 10\%$			-80		dB
	Reference Short-Circuit Current	$V_{CC} = 5.5\text{V}$, Forcing REFIN/OUT to GND	●			5	mA
	REFCOMP Pin Short-Circuit Current	$V_{CC} = 5.5\text{V}$, Forcing REFCOMP to GND	●			200	μA
	Reference Load Regulation	$V_{CC} = 3\text{V} \pm 10\%$ or $5\text{V} \pm 10\%$, $I_{OUT} = 100\mu\text{A}$ Sourcing			40		mV/mA
	Reference Output Voltage Noise Density	$C_{REFCOMP} = C_{REFIN/OUT} = 0.1\mu\text{F}$ at $f = 1\text{kHz}$			35		nV/ $\sqrt{\text{Hz}}$
	Reference Input Range	External Reference Mode (Note 14)	●	0.5		$V_{CC}/2$	V
	Reference Input Current		●		0.001	1	μA
	Reference Input Capacitance	(Note 9)	●		40		pF

Power Supply

V_{CC}	Positive Supply Voltage	For Specified Performance	●	4.5		5.5	V
I_{CC}	Supply Current (Note 8)	$V_{CC} = 5\text{V}$, Internal Reference On $V_{CC} = 5\text{V}$, Internal Reference Off	● ●		3.3 3	4.25 3.7	mA mA
I_{SD}	Supply Current in Shutdown Mode (Note 8)	$V_{CC} = 5\text{V}$	●			3	μA

Digital I/O

V_{IL}	Low Level Input Voltage (SDA and SCL)		●			$0.3V_{CC}$	V
V_{IH}	High Level Input Voltage (SDA and SCL)		●	$0.7V_{CC}$			V
$V_{IL(LDAC)}$	Low Level Input Voltage (LDAC)	$V_{CC} = 4.5\text{V}$ to 5.5V	●			0.8V	V
$V_{IH(LDAC)}$	High Level Input Voltage (LDAC)	$V_{CC} = 4.5\text{V}$ to 5.5V	●	2.4			V
$V_{IL(CA)}$	Low Level Input Voltage (CA0 to CA2)	See Test Circuit 1	●			$0.15V_{CC}$	V
$V_{IH(CA)}$	High Level Input Voltage (CA0 to CA2)	See Test Circuit 1	●	$0.85V_{CC}$			V
R_{INH}	Resistance from CA_n ($n = 0, 1, 2$) to V_{CC} to Set $CA_n = V_{CC}$	See Test Circuit 2	●			10	k Ω
R_{INL}	Resistance from CA_n ($n = 0, 1, 2$) to GND to Set $CA_n = \text{GND}$	See Test Circuit 2	●			10	k Ω
R_{INF}	Resistance from CA_n ($n = 0, 1, 2$) to V_{CC} or GND to Set $CA_n = \text{FLOAT}$	See Test Circuit 2	●	2			M Ω
V_{OL}	Low Level Output Voltage	Sink Current = 3mA	●	0		0.4	V

ELECTRICAL CHARACTERISTICS

The ● denotes the specifications which apply over the full operating temperature range, otherwise specifications are at $T_A = 25^\circ\text{C}$. $V_{CC} = 4.5\text{V}$ to 5.5V , V_{OUT} unloaded unless otherwise specified. LTC2657B-H16/LTC2657-H12 (Internal Reference = 2.048V)

SYMBOL	PARAMETER	CONDITIONS		MIN	TYP	MAX	UNITS
t_{OF}	Output Fall Time	$V_O = V_{IH(MIN)}$ to $V_O = V_{IL(MAX)}$, $C_B = 10\text{pF}$ to 400pF (Note 13)	●	$20+0.1C_B$		250	ns
t_{SP}	Pulse Width of Spikes Suppressed by Input Filter		●	0		50	ns
I_{IN}	Input Leakage	$0.1V_{CC} \leq V_{IN} \leq 0.9V_{CC}$	●			1	μA
C_{IN}	I/O Pin Capacitance	(Note 9)	●			10	pF
C_B	Capacitance Load for Each Bus Line		●			400	pF
C_{CA_n}	External Capacitive Load on Address Pins CA0, CA1 and CA2		●			10	pF

The ● denotes the specifications which apply over the full operating temperature range, otherwise specifications are at $T_A = 25^\circ\text{C}$. $V_{CC} = 2.7\text{V}$ to 5.5V , V_{OUT} unloaded unless otherwise specified. LTC2657B-H16/LTC2657-H12/ LTC2657B-L16/LTC2657-L12

SYMBOL	PARAMETER	CONDITIONS		MIN	TYP	MAX	UNITS
AC Performance							
t_S	Settling Time (Note 10)	$\pm 0.024\%$ ($\pm 1\text{LSB}$ at 12 Bits)			3.9		μs
		$\pm 0.0015\%$ ($\pm 1\text{LSB}$ at 16 Bits)			9.1		μs
	Settling Time for 1LSB Step	$\pm 0.024\%$ ($\pm 1\text{LSB}$ at 12 Bits)			2.4		μs
		$\pm 0.0015\%$ ($\pm 1\text{LSB}$ at 16 Bits)			4.5		μs
	Voltage Output Slew Rate				1.8		$\text{V}/\mu\text{s}$
	Capacitive Load Driving				1000		pF
	Glitch Impulse (Note 11)	At Mid-Scale Transition, L-Option			4		$\text{nV}\cdot\text{s}$
		At Mid-Scale Transition, H-Option			7		$\text{nV}\cdot\text{s}$
	DAC-to-DAC Crosstalk (Note 12)	$C_{REFCOMP} = C_{REFIN/OUT} = 0.22\mu\text{F}$			0.8		$\text{nV}\cdot\text{s}$
	Multiplying Bandwidth				150		kHz
e_n	Output Voltage Noise Density	At $f = 1\text{kHz}$			85		$\text{nV}/\sqrt{\text{Hz}}$
		At $f = 10\text{kHz}$			80		$\text{nV}/\sqrt{\text{Hz}}$
	Output Voltage Noise	0.1Hz to 10Hz, Internal Reference (L-Options)			8		μV_{P-P}
		0.1Hz to 10Hz, Internal Reference (H-Options)			12		μV_{P-P}
		0.1Hz to 200kHz, Internal Reference (L-Options)			600		μV_{P-P}
		0.1Hz to 200kHz, Internal Reference (H-Options)			650		μV_{P-P}

TIMING CHARACTERISTICS

The ● denotes the specifications which apply over the full operating temperature range, otherwise specifications are at $T_A = 25^\circ\text{C}$. LTC2657B-L16/LTC2657-L12/LTC2657B-H16/LTC2657-H12 (see Figure 1).

SYMBOL	PARAMETER	CONDITIONS	MIN	TYP	MAX	UNITS
$V_{CC} = 2.7\text{V to } 5.5\text{V}$						
f_{SCL}	SCL Clock Frequency		●	0	400	kHz
$t_{\text{HD(STA)}}$	Hold Time (Repeated) Start Condition		●	0.6		μs
t_{LOW}	Low Period of the SCL Clock Pin		●	1.3		μs
t_{HIGH}	High Period of the SCL Clock Pin		●	0.6		μs
$t_{\text{SU(STA)}}$	Set-Up Time for a Repeated Start Program		●	0.6		μs
$t_{\text{HD(DAT)}}$	Data Hold Time		●	0	0.9	μs
$t_{\text{SU(DAT)}}$	Data Set-Up Time		●	100		ns
t_r	Rise Time of Both SDA and SCL Signals		●	$20+0.1C_B$	300	ns
t_f	Fall Time of Both SDA and SCL Signals		●	$20+0.1C_B$	300	ns
$t_{\text{SU(STO)}}$	Set-Up Time for Stop Condition		●	0.6		μs
t_{BUF}	Bus Free Time Between a Stop and Start Condition		●	1.3		μs
t_1	Falling edge of the 9th Clock of the 3rd Input Byte to LDAC High or Low Transition		●	400		ns
t_2	LDAC Low Pulse Width		●	20		ns

Note 1: Stresses beyond those listed under Absolute Maximum Ratings may cause permanent damage to the device. Exposure to any Absolute Maximum Rating condition for extended periods may affect device reliability and lifetime.

Note 2: All voltages are with respect to GND.

Note 3: Linearity and monotonicity are defined from code k_L to code $2^N - 1$, where N is the resolution and k_L is the lower end code for which no output limiting occurs. For $V_{\text{REF}} = 2.5\text{V}$ and $N = 16$, $k_L = 128$ and linearity is defined from code 128 to code 65535. For $V_{\text{REF}} = 2.5\text{V}$ and $N = 12$, $k_L = 8$ and linearity is defined from code 8 to code 4,095.

Note 4: Inferred from measurement at code 128 (LTC2657-16) or code 8 (LTC2657-12).

Note 5: DC crosstalk is measured with $V_{\text{CC}} = 5\text{V}$ and using internal reference with the measured DAC at mid-scale.

Note 6: This IC includes current limiting that is intended to protect the device during momentary overload conditions. Junction temperature can exceed the rated maximum during current limiting. Continuous operation above the specified maximum operating junction temperature may impair device reliability.

Note 7: Temperature coefficient is calculated by dividing the maximum change in output voltage by the specified temperature range.

Note 8: Digital inputs at 0V or V_{CC} .

Note 9: Guaranteed by design and not production tested.

Note 10: Internal reference mode. DAC is stepped 1/4 scale to 3/4 scale and 3/4 scale to 1/4 scale. Load is $2\text{k}\Omega$ in parallel with 200pF to GND.

Note 11: $V_{\text{CC}} = 5\text{V}$ (H-Options) or $V_{\text{CC}} = 3\text{V}$ (L-Options), internal reference mode. DAC is stepped $\pm 1\text{LSB}$ between half-scale and half-scale -1 . Load is $2\text{k}\Omega$ in parallel with 200pF to GND.

Note 12: DAC-to-DAC crosstalk is the glitch that appears at the output of one DAC due to a full-scale change at the output of another DAC. It is measured with $V_{\text{CC}} = 5\text{V}$, using internal reference, with the measured DAC at mid-scale.

Note 13: C_B = capacitance of one bus line in pF.

Note 14: Gain error specification may be degraded for reference input voltages less than 1V. See Gain Error vs Reference Input curve in the Typical Performance Characteristics section.

TYPICAL PERFORMANCE CHARACTERISTICS LTC2657-L16, $T_A = 25^\circ\text{C}$ unless otherwise noted.

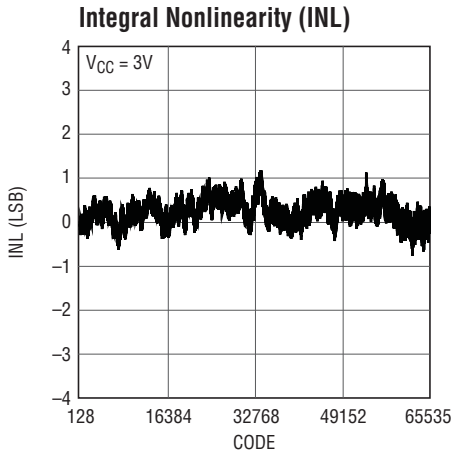

2657 G01

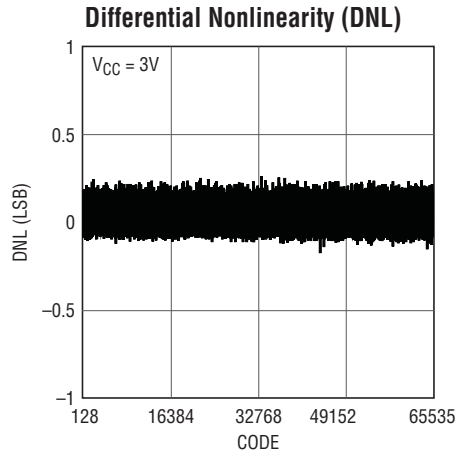

2657 G02

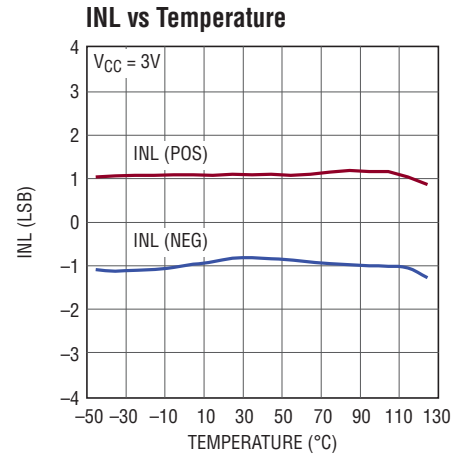

2657 G03

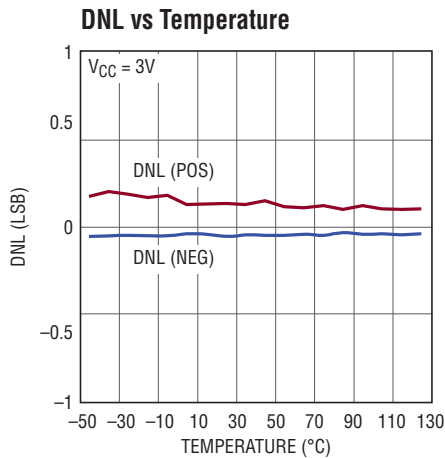

3586 G35

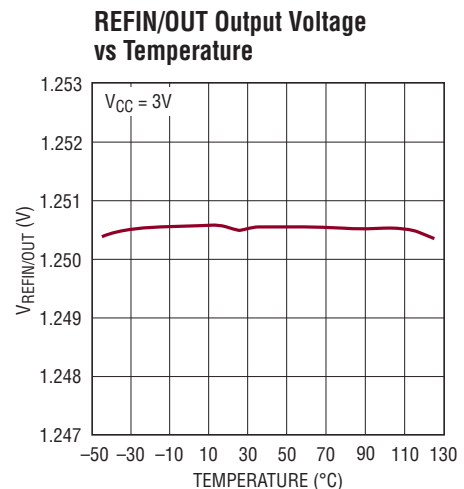

2657 G05

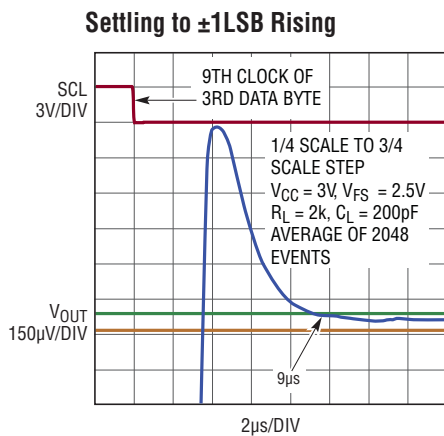

2657 G07

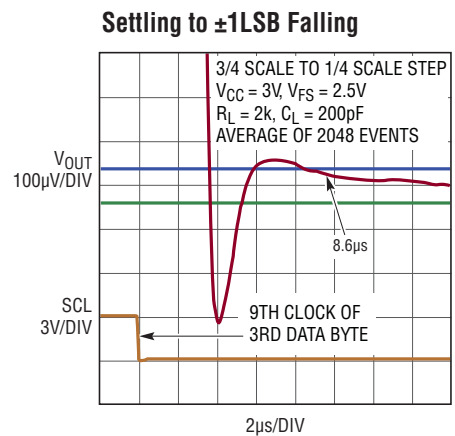

2657 G08

TYPICAL PERFORMANCE CHARACTERISTICS LTC2657-H16, $T_A = 25^\circ\text{C}$ unless otherwise noted.

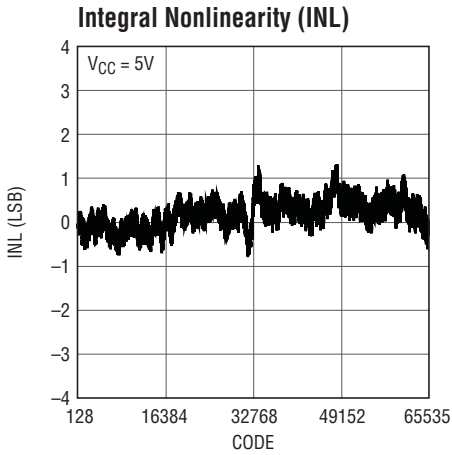

2657 G10

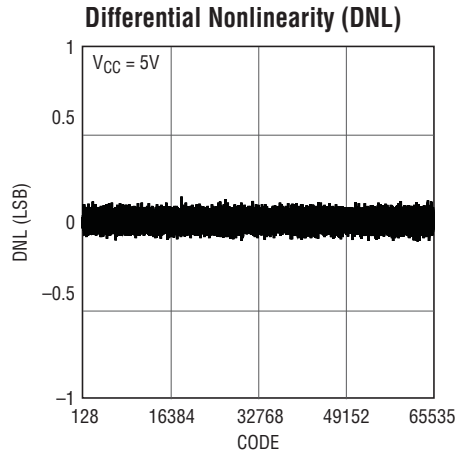

2657 G011

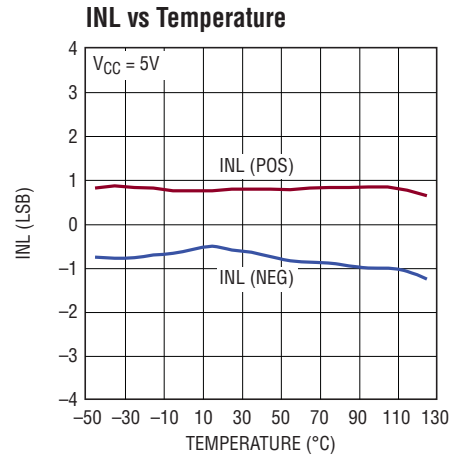

3586 G35

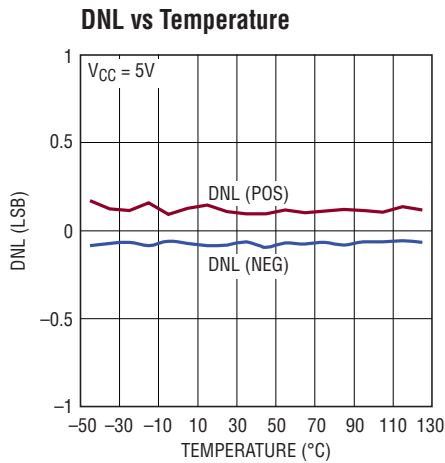

2657 G13

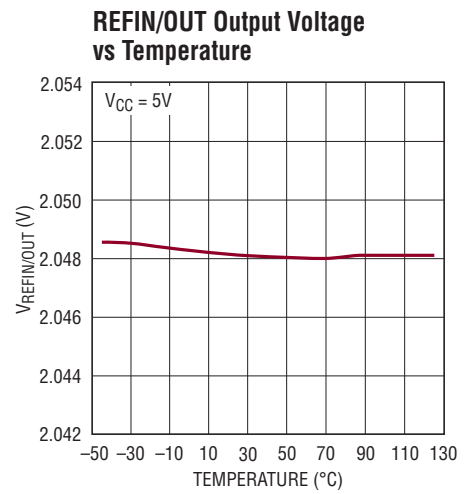

2657 G14

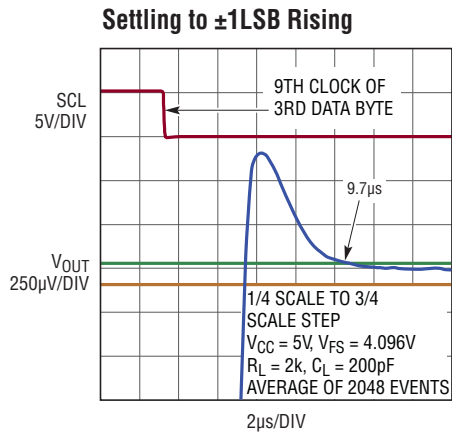

2657 G16

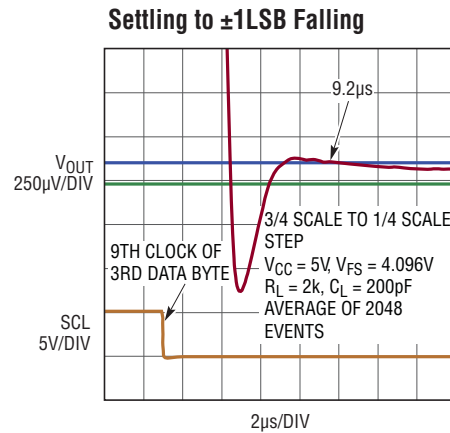

2657 G17

TYPICAL PERFORMANCE CHARACTERISTICS LTC2657-12, $T_A = 25^\circ\text{C}$ unless otherwise noted.

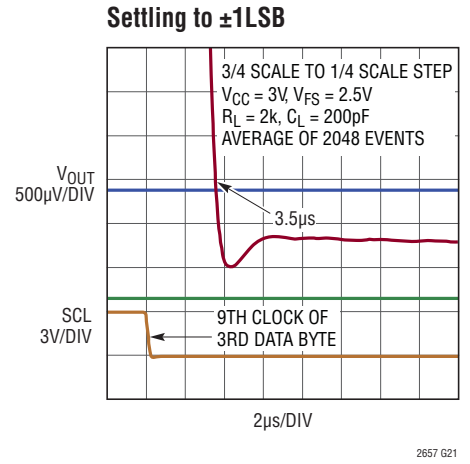
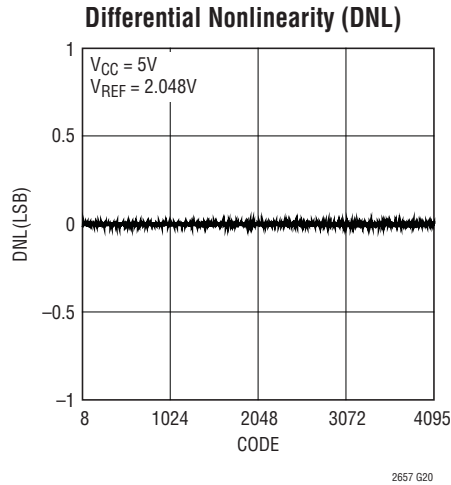
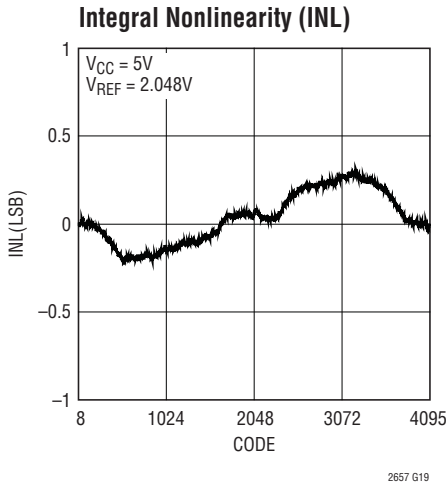

LTC2657

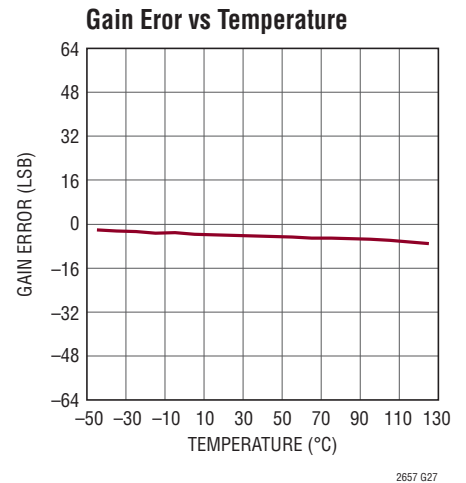
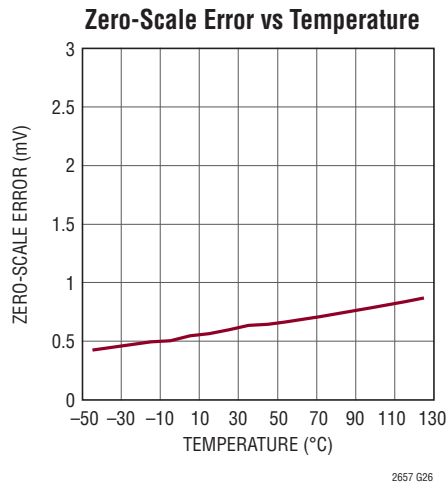
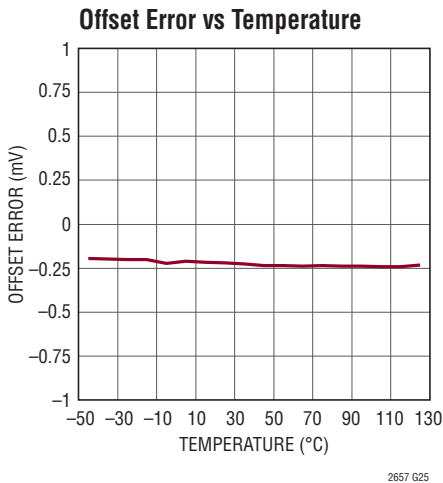
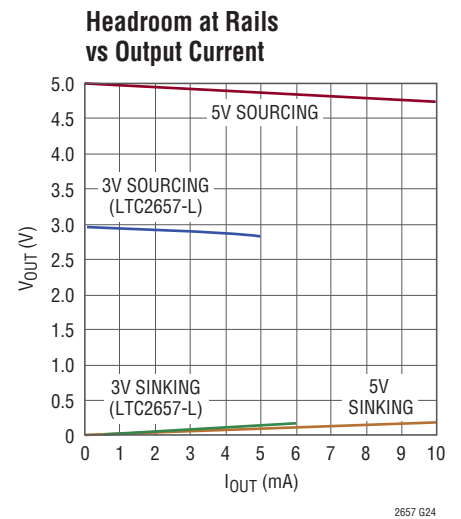
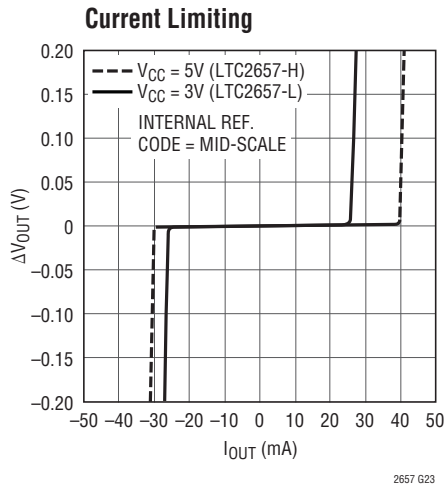
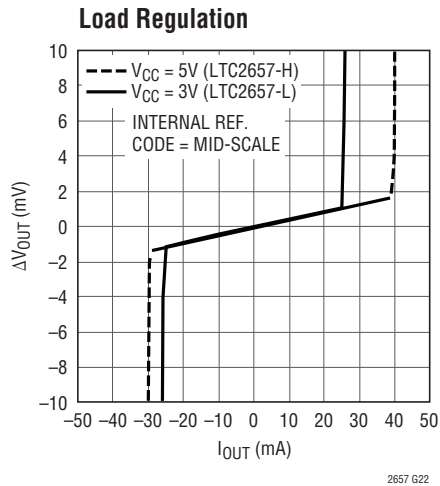

TYPICAL PERFORMANCE CHARACTERISTICS LTC2657, $T_A = 25^\circ\text{C}$ unless otherwise noted.

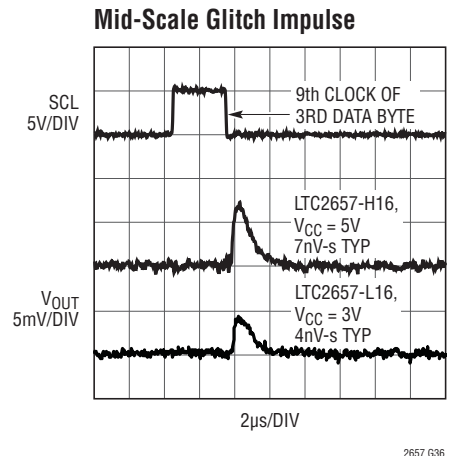
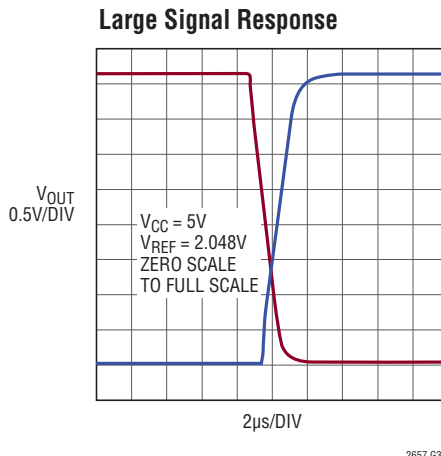
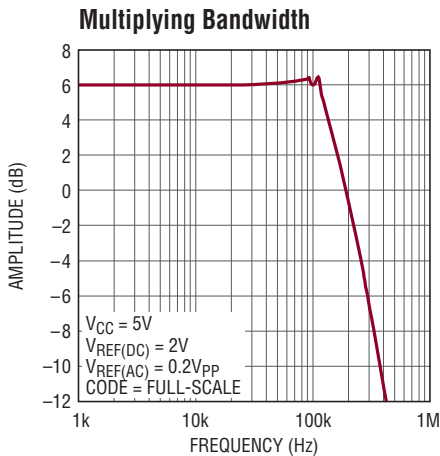
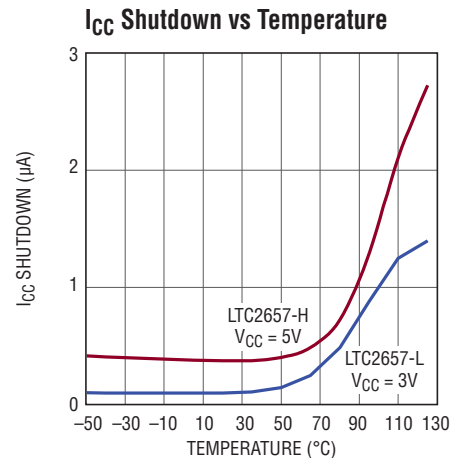
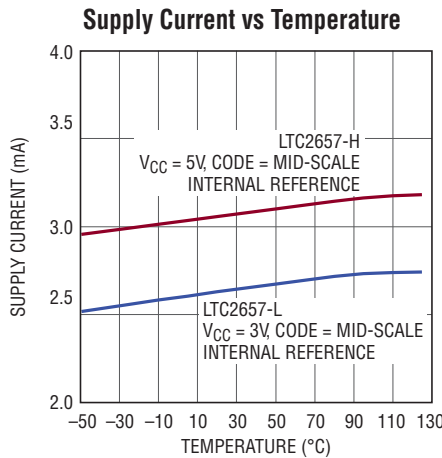
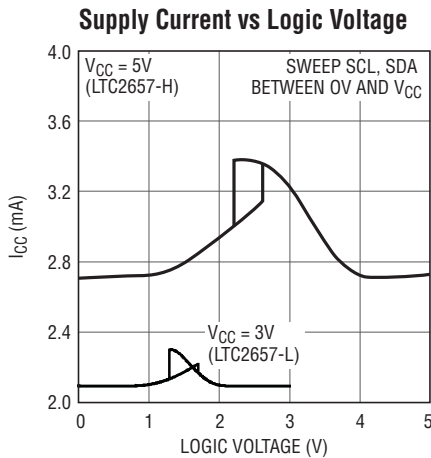
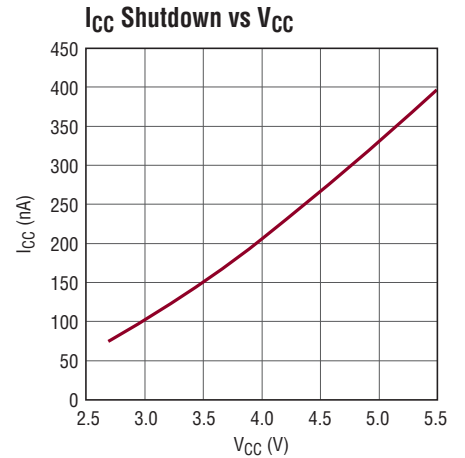
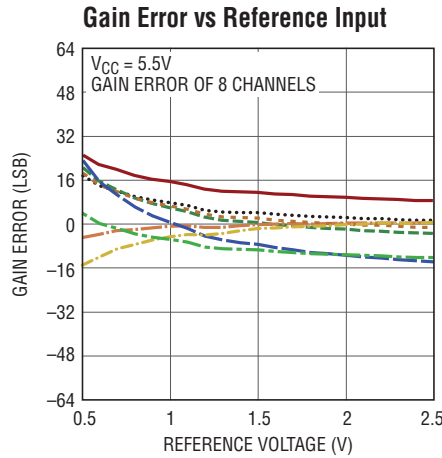
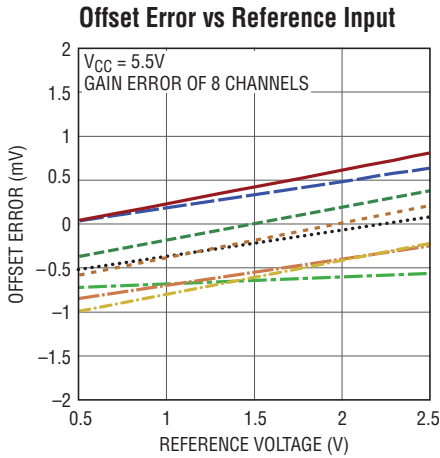

TYPICAL PERFORMANCE CHARACTERISTICS LTC2657

DAC to DAC Crosstalk (Dynamic)

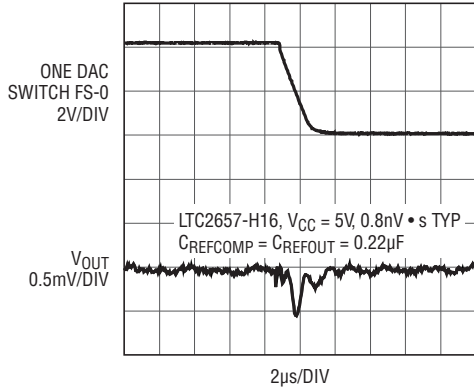

Power On Reset to Zero-Scale

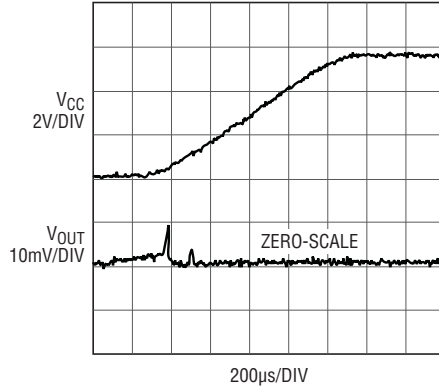

Power On Reset to Mid-Scale

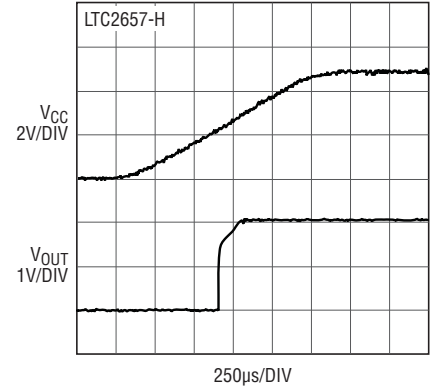

Noise Voltage Density vs Frequency

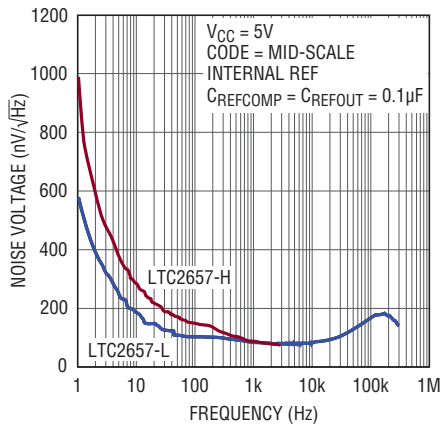

DAC Output 0.1Hz to 10Hz Voltage Noise

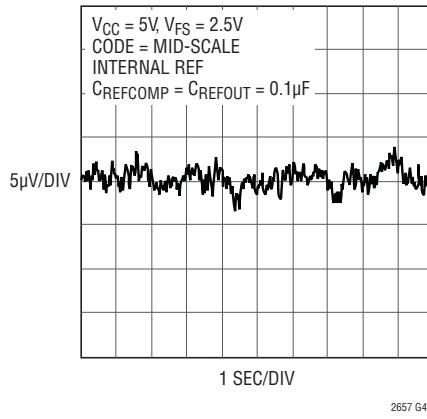

Reference Output 0.1Hz to 10Hz Voltage Noise

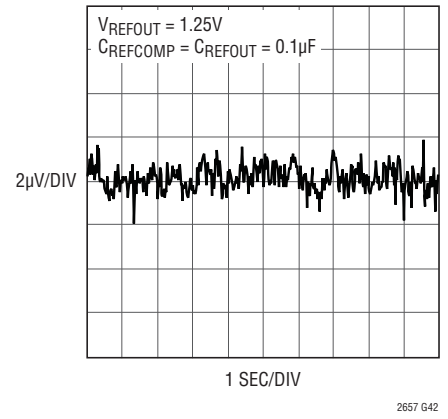

PIN FUNCTIONS (QFN/TSSOP)

V_{OUTA} to V_{OUTH} (Pins 1, 3, 4, 13, 14, 15, 16, 20/Pins 2, 3, 5, 6, 15, 16, 17, 18): DAC Analog Voltage Outputs. The output range is 0V to 2 times the voltage at the REFIN/OUT pin.

REFCOMP (Pin 2/Pin 4): Internal Reference Compensation pin. For low noise and reference stability, tie 0.1 μ F cap to GND. Connect to GND to use an external reference at start-up. Command 0111b must still be issued to turn off internal reference.

REFIN/OUT (Pin 5/Pin 7): This pin acts as the Internal Reference output in Internal Reference mode and acts as the Reference Input pin in External Reference mode. When acting as an output the nominal voltage at this pin is 1.25V for -L Options and 2.048V for -H Options. For low noise and reference stability tie a capacitor to GND. Capacitor value must be $\leq C_{REFCOMP}$. In External Reference mode, the allowable reference input voltage range is 0.5V to $V_{CC}/2$.

LDAC (Pin 6/Pin 8): Asynchronous DAC Update Pin. A falling edge on this input after four bytes have been written into the part immediately updates the DAC register with the contents of the input register. A low on this input without a complete 32-bit (four bytes including the slave address) data write transfer to the part does not update the DAC output. Software power-down is disabled when \overline{LDAC} is low.

CA2 (Pin 9/Pin 7): Chip Address Bit 2. Tie this pin to V_{CC} , GND or leave it floating to select an I²C slave address for the part (See Table 2).

SCL (Pin 8/Pin 10): Serial Clock Input Pin. Data is shifted into the SDA pin at the rising edges of the clock.

This high impedance pin requires a pull-up resistor or current source to V_{CC} .

SDA (Pin 9/Pin 11): Serial Data Bidirectional Pin. Data is shifted into the SDA pin and acknowledged by the SDA pin. This is a high impedance pin while data is shifted in. It is an open-drain N-channel output during acknowledgement. This pin requires a pull-up resistor or current source to V_{CC} .

CA1 (Pin 10/Pin 12): Chip Address Bit 1. Tie this pin to V_{CC} , GND or leave it floating to select an I²C slave address for the part (See Table 2)

CA0 (Pin 11/Pin 13): Chip Address Bit 0. Tie this pin to V_{CC} , GND or leave it floating to select an I²C slave address for the part (See Table 2).

PORSEL (Pin 12/Pin 14): Power-On-Reset Select pin. If tied to GND, the part resets to Zero-Scale at power up. If tied to V_{CC} , the part resets to Mid-Scale at power up.

V_{CC} (Pin 17/Pin 19): Supply Voltage Input. For -L Options, $2.7V \leq V_{CC} \leq 5.5V$, and for -H Options, $4.5V \leq V_{CC} \leq 5.5V$. Bypass to ground with a 0.1 μ F capacitor placed as close to pin as possible.

GND (Pin 18/Pin 20): Ground.

REFLO (Pin 19/Pin 1): Reference Low pin. The voltage at this pin sets the zero-scale voltage of all DACs. This pin should be tied to GND.

Exposed Pad (Pin 21/Pin 21): Ground. Must be Soldered to PCB Ground.

BLOCK DIAGRAM

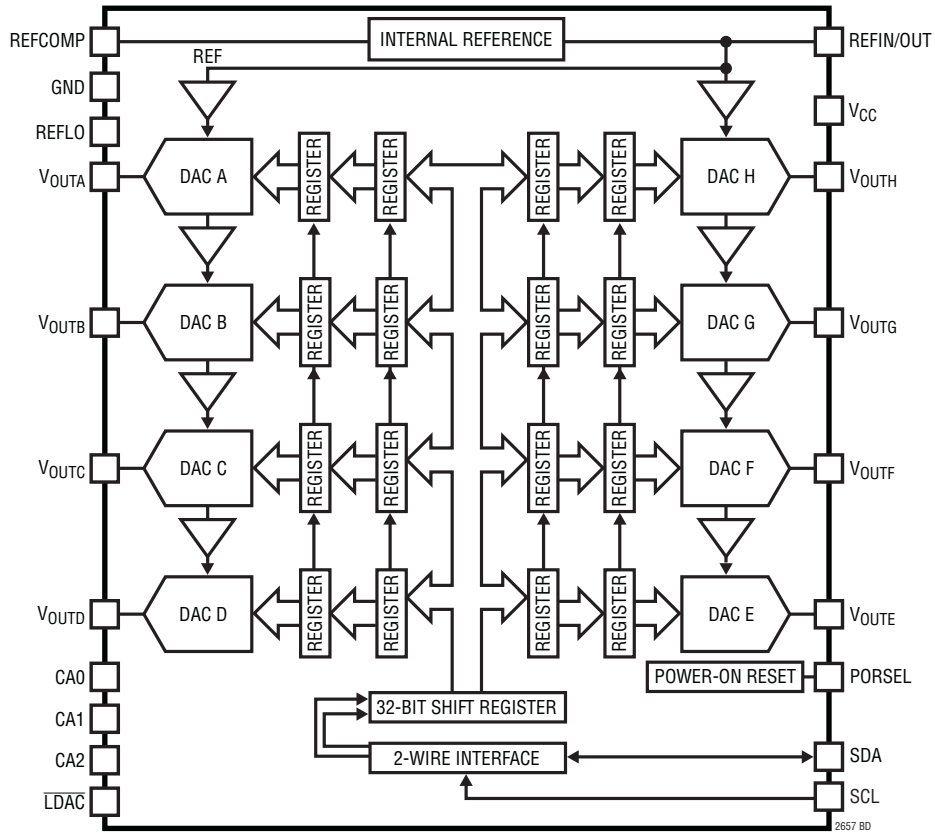

TEST CIRCUIT

Test Circuit 1

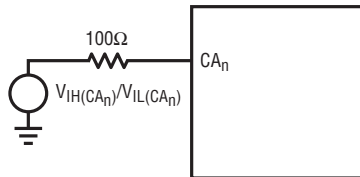

Test Circuit 2

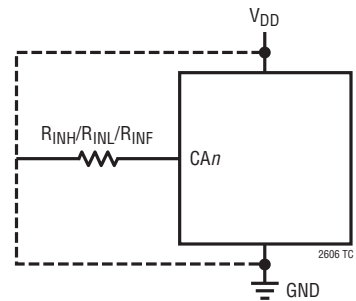

TIMING DIAGRAM

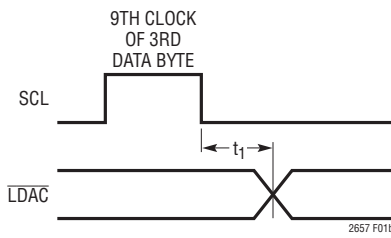
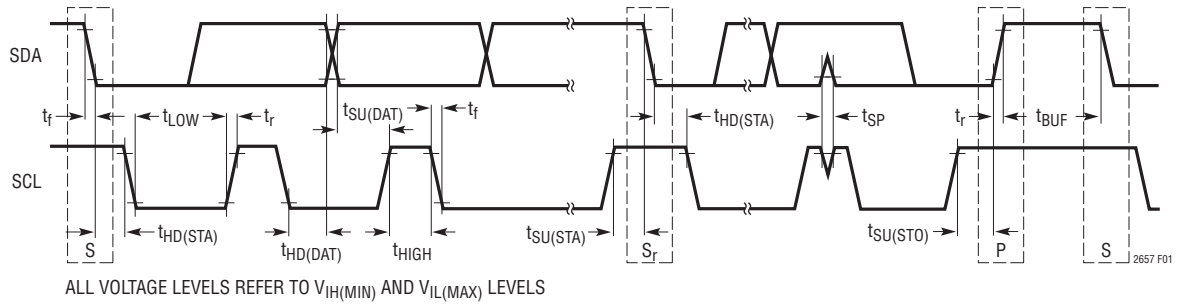

Figure 1

OPERATION

The LTC2657 is a family of octal voltage output DACs in 20-lead 4mm × 5mm QFN and in 20-lead thermally enhanced TSSOP packages. Each DAC can operate rail-to-rail in external reference mode, or with its full-scale voltage set by an integrated reference. Four combinations of accuracy (16- and 12-bit), and full-scale voltage (2.5V or 4.096V) are available. The LTC2657 is controlled using a 2-wire I²C compatible interface.

Power-On Reset

The LTC2657-L/-H clear the output to zero-scale if the PORSEL pin is tied to GND when power is first applied, making system initialization consistent and repeatable. For some applications, downstream circuits are active during DAC power-up, and may be sensitive to nonzero outputs from the DAC during this time. The LTC2657 contains circuitry to reduce the power-on glitch. The analog outputs typically rise less than 10mV above zero-scale during power on if the power supply is ramped to 5V in 1ms or more. In general, the glitch amplitude decreases as the power supply ramp time is increased. See “Power-On Reset Glitch” in the Typical Performance Characteristics section.

Alternatively, if PORSEL is tied to V_{CC}, The LTC2657-L/-H set the output to mid-scale when power is first applied.

Power Supply Sequencing and Start-Up

For the LTC2657 family of parts, the internal reference is powered-up at start-up by default. If an external reference is to be used, the REFCOMP pin (Pin 4 –TSSOP, Pin 2 -QFN) must be hardwired to GND. This configuration allows the use of an external reference at start-up and converts the REFIN/OUT pin to an input. However, the internal reference will still be ON and draw supply current. In order to use an external reference, command 0111b should be used to turn the Internal Reference OFF.(See Table1.)

The voltage at REFIN/OUT (Pin 7 –TSSOP, Pin 5 -QFN) should be kept within the range $-0.3V \leq \text{REFIN/OUT} \leq V_{CC} + 0.3V$ (see Absolute Maximum Ratings). Particular care should be taken to observe these limits during power supply turn-on and turn-off sequences, when the voltage at V_{CC} (Pin 19 –TSSOP, Pin 17 -QFN) is in transition.

Transfer Function

The digital-to-analog transfer function is:

$$V_{\text{OUT(IDEAL)}} = \left(\frac{k}{2^N}\right) \cdot 2 \cdot [V_{\text{REF}} - \text{REFLO}] + \text{REFLO}$$

where k is the decimal equivalent of the binary DAC input code, N is the resolution, and V_{REF} is the voltage at the REFIN/OUT Pin. The resulting DAC output span is 0V to 2 • V_{REF}, as it is necessary to tie REFLO to GND. V_{REF} is nominally 1.25V for LTC2657-L and 2.048V for LTC2657-H, in Internal Reference Mode.

Table 1. Command and Address Codes

COMMAND*				
C3	C2	C1	C0	
0	0	0	0	Write to Input Register n
0	0	0	1	Update (Power Up) DAC Register n
0	0	1	0	Write to Input Register n, Update (Power Up) All
0	0	1	1	Write to and Update (Power Up) n
0	1	0	0	Power Down n
0	1	0	1	Power Down Chip (All DACs and Reference)
0	1	1	0	Select Internal Reference (Power-Up Reference)
0	1	1	1	Select External Reference (Power-Down Reference)
1	1	1	1	No Operation
ADDRESS (n)*				
A3	A2	A1	A0	
0	0	0	0	DAC A
0	0	0	1	DAC B
0	0	1	0	DAC C
0	0	1	1	DAC D
0	1	0	0	DAC E
0	1	0	1	DAC F
0	1	1	0	DAC G
0	1	1	1	DAC H
1	1	1	1	All DACs

*Command and address codes not shown are reserved and should not be used.

Serial Interface

The LTC2657 communicates with a host using the standard 2-wire I²C interface. The Timing Diagrams (Figures 1 and 2) show the timing relationship of the signals on the bus. The two bus lines, SDA and SCL, must be high when the bus is not in use. External pull-up resistors or current sources are required on these lines. The value of

OPERATION

these pull-up resistors is dependent on the power supply and can be obtained from the I²C specifications. For an I²C bus operating in the fast mode, an active pull-up will be necessary if the bus capacitance is greater than 200pF. The LTC2657 is a receive-only (slave) device. The master can write to the LTC2657. The LTC2657 does not respond to a read command from the master.

The START (S) and STOP (P) Conditions

When the bus is not in use, both SCL and SDA must be high. A bus master signals the beginning of a communication to a slave device by transmitting a START condition (See Figure 1). A START condition is generated by transitioning SDA from high to low while SCL is high. When the master has finished communicating with the slave, it issues a STOP condition. A STOP condition is generated by transitioning SDA from low to high while SCL is high. The bus is then free for communication with another I²C device.

Acknowledge

The Acknowledge signal is used for handshaking between the master and the slave. An Acknowledge (active LOW) generated by the slave lets the master know that the latest byte of information was received. The Acknowledge related clock pulse is generated by the master. The master releases the SDA line (HIGH) during the Acknowledge clock pulse. The slave-receiver must pull down the SDA bus line during the Acknowledge clock pulse so that it remains a stable LOW during the HIGH period of this clock pulse. The LTC2657 responds to a write by a master in this manner. The LTC2657 does not acknowledge a read (retains SDA HIGH during the period of the Acknowledge clock pulse).

Chip Address

The state of CA0, CA1 and CA2 decides the slave address of the part. The pins CA0, CA1 and CA2 can be each set to any one of three states: V_{CC}, GND or float. This results in 27 selectable addresses for the part. The slave address assignments are shown in Table 2.

Table 2. Slave Address Map

CA2	CA1	CA0	A6	A5	A4	A3	A2	A1	A0
GND	GND	GND	0	0	1	0	0	0	0
GND	GND	FLOAT	0	0	1	0	0	0	1
GND	GND	V _{CC}	0	0	1	0	0	1	0
GND	FLOAT	GND	0	0	1	0	0	1	1
GND	FLOAT	FLOAT	0	1	0	0	0	0	0
GND	FLOAT	V _{CC}	0	1	0	0	0	0	1
GND	V _{CC}	GND	0	1	0	0	0	1	0
GND	V _{CC}	FLOAT	0	1	0	0	0	1	1
GND	V _{CC}	V _{CC}	0	1	1	0	0	0	0
FLOAT	GND	GND	0	1	1	0	0	0	1
FLOAT	GND	FLOAT	0	1	1	0	0	1	0
FLOAT	GND	V _{CC}	0	1	1	0	0	1	1
FLOAT	FLOAT	GND	1	0	0	0	0	0	0
FLOAT	FLOAT	FLOAT	1	0	0	0	0	0	1
FLOAT	FLOAT	V _{CC}	1	0	0	0	0	1	0
FLOAT	V _{CC}	GND	1	0	0	0	0	1	1
FLOAT	V _{CC}	FLOAT	1	0	1	0	0	0	0
FLOAT	V _{CC}	V _{CC}	1	0	1	0	0	0	1
V _{CC}	GND	GND	1	0	1	0	0	1	0
V _{CC}	GND	FLOAT	1	0	1	0	0	1	1
V _{CC}	GND	V _{CC}	1	1	0	0	0	0	0
V _{CC}	FLOAT	GND	1	1	0	0	0	0	1
V _{CC}	FLOAT	FLOAT	1	1	0	0	0	1	0
V _{CC}	FLOAT	V _{CC}	1	1	0	0	0	1	1
V _{CC}	V _{CC}	GND	1	1	1	0	0	0	0
V _{CC}	V _{CC}	FLOAT	1	1	1	0	0	0	1
V _{CC}	V _{CC}	V _{CC}	1	1	1	0	0	1	0
GLOBAL ADDRESS			1	1	1	0	0	1	1

In addition to the address selected by the address pins, the parts also respond to a global address. This address allows a common write to all LTC2657 parts to be accomplished with one 3-byte write transaction on the I²C bus. The global address is a 7-bit on-chip hardwired address and is not selectable by CA0, CA1 and CA2. The addresses corresponding to the states of CA0, CA1 and CA2 and the global address are shown in Table 2. The maximum capacitive load allowed on the address pins (CA0, CA1 and CA2) is 10pF, as these pins are driven during address detection to determine if they are floating.

OPERATION

Write Word Protocol

The master initiates communication with the LTC2657 with a START condition and a 7-bit slave address followed by the Write bit (W) = 0. The LTC2657 acknowledges by pulling the SDA pin low at the 9th clock if the 7-bit slave address matches the address of the part (set by CA0, CA1 and CA2) or the global address. The master then transmits three bytes of write data. The LTC2657 acknowledges each byte of data by pulling the SDA line low at the 9th clock of each data byte transmission. After receiving three complete bytes of data, the LTC2657 executes the command specified in the 24-bit input word. If more than three data bytes are transmitted after a valid 7-bit slave address, the LTC2657 does not acknowledge the extra bytes of data (SDA is high during the 9th clock). The first byte of the input word consists of the 4-bit command followed by 4-bit address. The next two bytes consist of the 16-bit data word. The 16-bit data word consists of the 16- or 12-bit input code, MSB to LSB, followed by 0 or 4 don't care bits (LTC2657-16 and LTC2657-12, respectively). A typical LTC2657 write transaction is shown in Figure 2. The command (C3-C0) and address (A3-A0) assignments are shown in Table 1. The first four commands in the table consist of write and update operations. A write operation loads a 16-bit data word from the 32-bit shift register into the input register. In an update operation, the data word is copied from the input register to the DAC register and converted to an analog voltage at the DAC output. The update operation also powers up the DAC if it had been in power-down mode. The data path and registers are shown in the Block Diagram.

Power-Down Mode

For power-constrained applications, power-down mode can be used to reduce the supply current whenever less than eight outputs are needed. When in power-down, the buffer amplifiers, bias circuits and integrated reference circuits are disabled, and draw essentially zero current. The DAC outputs are put into a high-impedance state, and the output pins are passively pulled to ground through individual 80k resistors. Input- and DAC-register contents are not disturbed during power-down.

Any channel or combination of channels can be put into power-down mode by using command 0100b in

combination with the appropriate DAC address, (n). The integrated reference is automatically powered down when external reference mode is selected using command 0111b. In addition, all the DAC channels and the integrated reference together can be put into power-down mode using "Power-Down Chip" command 0101b. For all power-down commands the 16-bit data word is ignored, but still required in order to complete a full communication cycle.

Normal operation resumes by executing any command which includes a DAC update, in software as shown in Table 1 or using the asynchronous LDAC pin. The selected DAC is powered up as its voltage output is updated. When a DAC which is in a powered-down state is powered up and updated, normal settling is delayed. If less than eight DACs are in a powered-down state prior to the update command, the power-up delay time is 12 μ s. If on the other hand, all eight DACs and the integrated reference are powered down, then the main bias generation circuit block has been automatically shut down in addition to the individual DAC amplifiers and reference inputs. In this case, the power up delay time is 14 μ s. The power up of the integrated reference depends on the command that powered it down. If the reference is powered down using the "Select External Reference" command (0111b), then it can only be powered back up by sending "Select Internal Reference" command (0110b). However if the reference was powered down by sending "Power Down Chip" command (0101b), then in addition to "Select Internal Reference" command (0110b), any command that powers up the DACs will also power up the integrated reference.

Reference Modes

For applications where an accurate external reference is not available, the LTC2657 has a user-selectable, integrated reference. The LTC2657-L has a 1.25V reference that provides a full-scale output of 2.5V. The LTC2657-H has a 2.048V reference that provides a full-scale output of 4.096V. Both references exhibit a typical temperature drift of 2ppm/ $^{\circ}$ C. Internal Reference mode can be selected by using command 0110b, and is the power-on default. A buffer is needed if the internal reference is required to drive external circuitry. For reference stability and low noise, it is recommended that a 0.1 μ F capacitor be tied between REFCOMP and GND. In this configuration, the

OPERATION

internal reference can drive up to 0.1 μ F capacitive load without any stability problems. In order to ensure stable operation, the capacitive load on the REFIN/OUT pin should not exceed the capacitive load on the REFCOMP pin.

The DAC can also operate in External Reference mode using command 0111b. In this mode, the REFIN/OUT pin acts as an input that sets the DAC's reference voltage. The input is high impedance and does not load the external reference source. The acceptable voltage range at this pin is $0.5V \leq \text{REFIN/OUT} \leq V_{CC}/2$. The resulting full-scale output voltage is $2 \cdot V_{\text{REFIN/OUT}}$. For using External Reference at Start-Up, see the Power Supply Sequencing and Start-Up Section.

Integrated Reference Buffers

Each of the eight DACs in LTC2657 has its own integrated high performance reference buffer. The buffers have very high input impedance and do not load the reference voltage source. These buffers shield the Reference Voltage from glitches caused by DAC switching and thus minimize DAC-to-DAC Dynamic Crosstalk. See the curve DAC-to-DAC Crosstalk (Dynamic) in the Typical Performance Characteristics section.

Voltage Outputs

Each of the eight rail-to-rail amplifiers contained in LTC2657 has guaranteed load regulation when sourcing or sinking up to 15mA at 5V (7.5mA at 3V).

Load regulation is a measure of the amplifier's ability to maintain the rated voltage accuracy over a wide range of load conditions. The measured change in output voltage per milliampere of forced load current change is expressed in LSB/mA.

DC output impedance is equivalent to load regulation, and may be derived from it by simply calculating a change in units from LSB/mA to Ohms. The amplifiers' DC output impedance is 0.040 Ω when driving a load well away from the rails.

When drawing a load current from either rail, the output voltage headroom with respect to that rail is limited by the 30 Ω typical channel resistance of the output devices; e.g., when sinking 1mA, the minimum output voltage = $30\Omega \cdot 1\text{mA} = 30\text{mV}$. See the graph Headroom at Rails vs Output Current in the Typical Performance Characteristics section.

The amplifiers are stable driving capacitive loads of up to 1000pF.

Board Layout

The excellent load regulation and DC crosstalk performance of these devices is achieved in part by keeping "signal" and "power" grounds separate.

The PC board should have separate areas for the analog and digital sections of the circuit. This keeps digital signals away from sensitive analog signals and facilitates the use of separate digital and analog ground planes which have minimal capacitive and resistive interaction with each other.

Digital and analog ground planes should be joined at only one point, establishing a system star ground as close to the device's ground pin as possible. Ideally, the analog ground plane should be located on the component side of the board, and should be allowed to run under the part to shield it from noise. Analog ground should be a continuous and uninterrupted plane, except for necessary lead pads and vias, with signal traces on another layer.

The GND pin functions as a return path for power supply currents in the device and should be connected to analog ground. The REFLO pin should be connected to system star ground. Resistance from the REFLO pin to system star ground should be as low as possible.

Rail-to-Rail Output Considerations

In any rail-to-rail voltage output device, the output is limited to voltages within the supply range.

Since the analog outputs of the device cannot go below ground, they may limit for the lowest codes as shown in Figure 3b. Similarly, limiting can occur in External Reference mode near full-scale when the REFIN/OUT pin is at $V_{CC}/2$. If $V_{\text{REFIN/OUT}} = V_{CC}/2$ and the DAC full-scale error (FSE) is positive, the output for the highest codes limits at V_{CC} as shown in Figure 3c. No full-scale limiting can occur if $V_{\text{REFIN/OUT}} \leq (V_{CC} - \text{FSE})/2$.

Offset and linearity are defined and tested over the region of the DAC transfer function where no output limiting can occur.

OPERATION

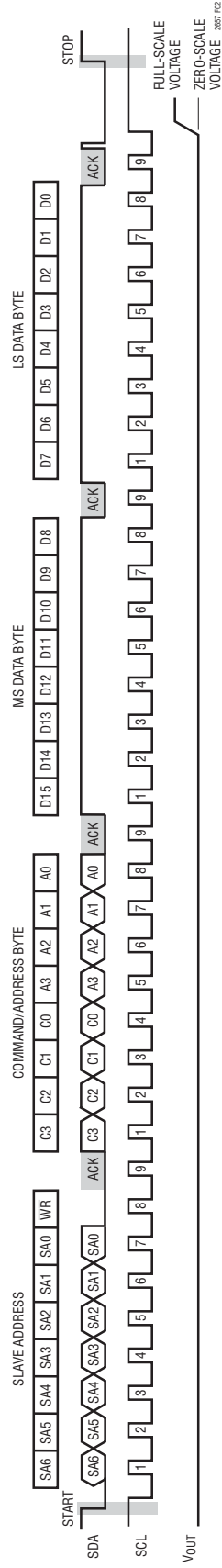

Figure 2. Typical LTC2657 Input Waveform – Programming DAC Output for Full-Scale

OPERATION

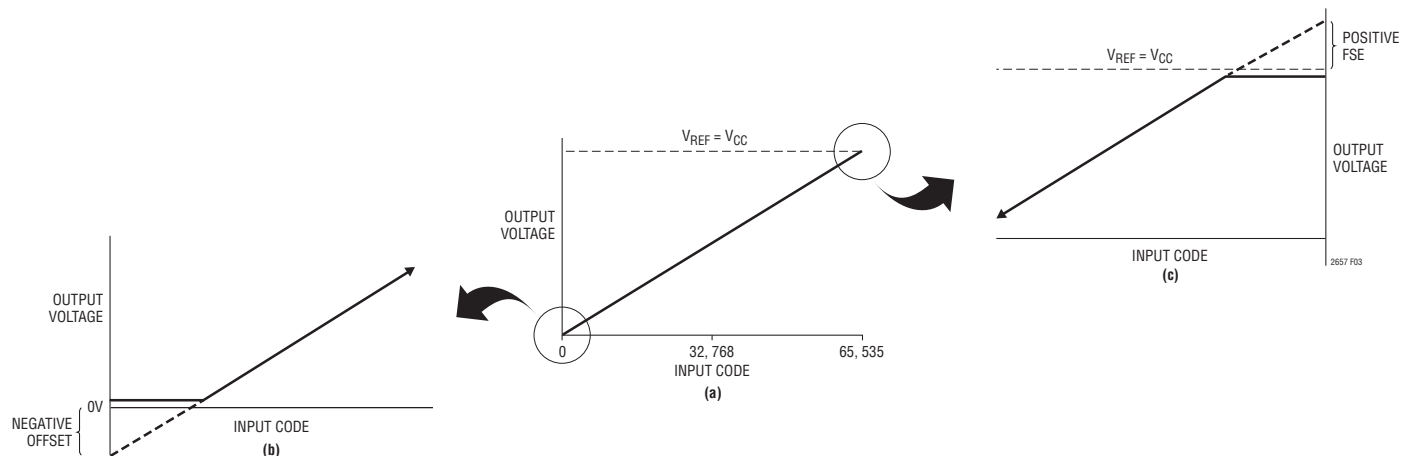
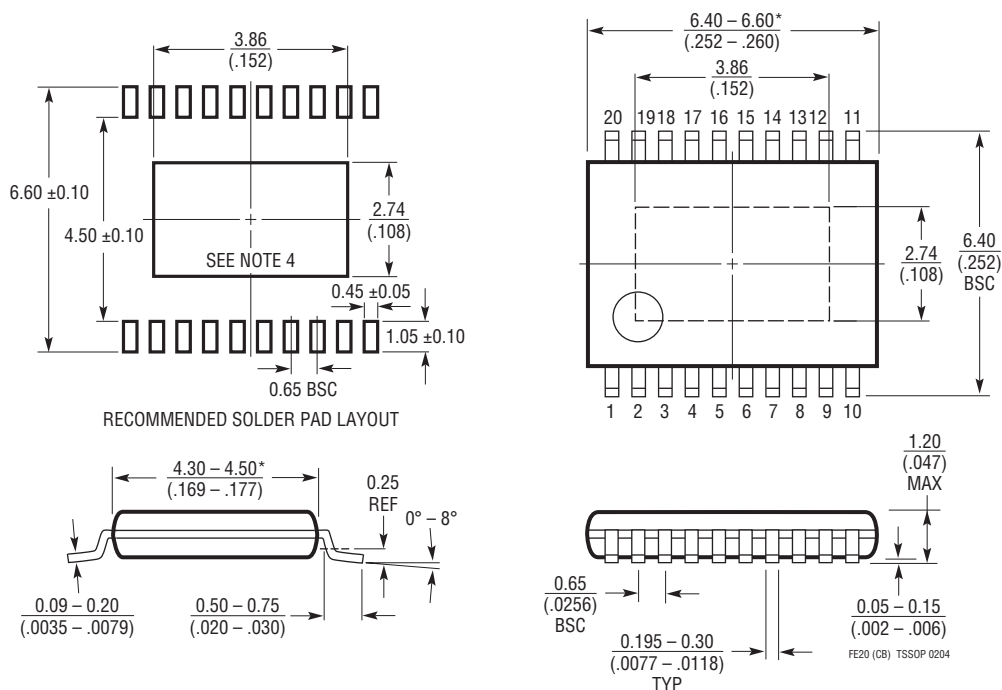

Figure 3. Effects of Rail-to-Rail Operation on a DAC Transfer Curve. (a) Overall Transfer Function (b) Effect of Negative Offset for Codes Near Zero-Scale (c) Effect of Positive Full-Scale Error for Codes Near Full-Scale

PACKAGE DESCRIPTION

FE Package
20-Lead Plastic TSSOP (4.4mm)
 (Reference LTC DWG # 05-08-1663)
Exposed Pad Variation CB



- NOTE:
1. CONTROLLING DIMENSION: MILLIMETERS
 2. DIMENSIONS ARE IN MILLIMETERS (INCHES)
 3. DRAWING NOT TO SCALE
 4. RECOMMENDED MINIMUM PCB METAL SIZE FOR EXPOSED PAD ATTACHMENT
- *DIMENSIONS DO NOT INCLUDE MOLD FLASH. MOLD FLASH SHALL NOT EXCEED 0.150mm (.006") PER SIDE

PACKAGE DESCRIPTION

UFD Package
20-Lead Plastic QFN (4mm × 5mm)
 (Reference LTC DWG # 05-08-1711 Rev B)

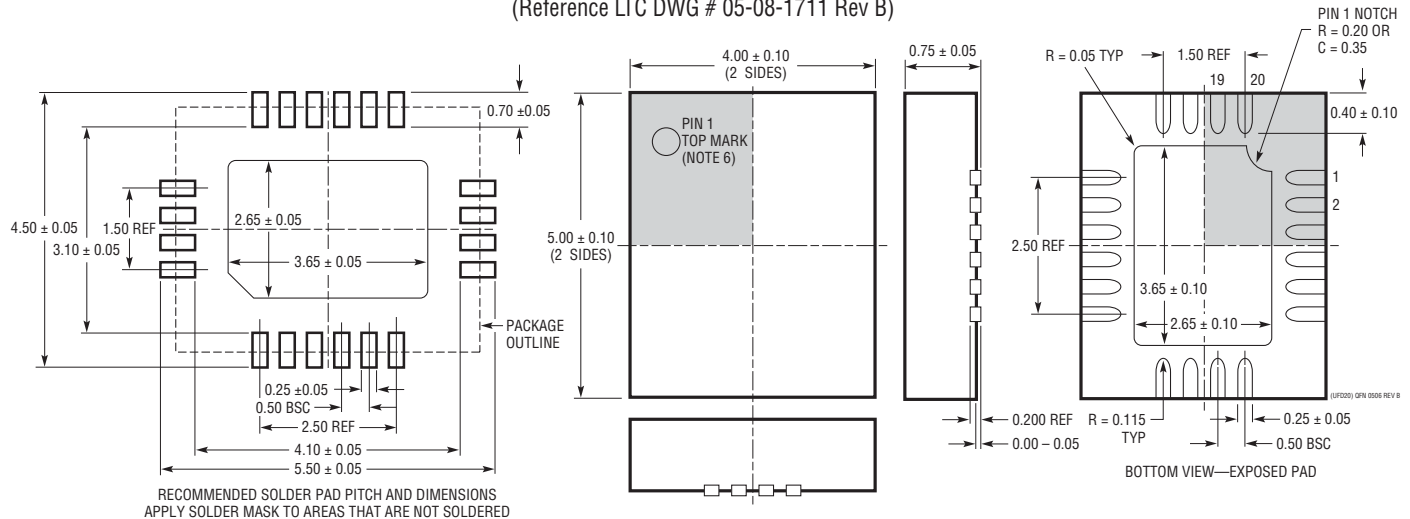

RECOMMENDED SOLDER PAD PITCH AND DIMENSIONS
 APPLY SOLDER MASK TO AREAS THAT ARE NOT SOLDERED

- NOTE:
1. DRAWING PROPOSED TO BE MADE A JEDEC PACKAGE OUTLINE MO-220 VARIATION (WXXX-X).
 2. DRAWING NOT TO SCALE
 3. ALL DIMENSIONS ARE IN MILLIMETERS

4. DIMENSIONS OF EXPOSED PAD ON BOTTOM OF PACKAGE DO NOT INCLUDE MOLD FLASH. MOLD FLASH, IF PRESENT, SHALL NOT EXCEED 0.15mm ON ANY SIDE
5. EXPOSED PAD SHALL BE SOLDER PLATED
6. SHADED AREA IS ONLY A REFERENCE FOR PIN 1 LOCATION ON THE TOP AND BOTTOM OF PACKAGE

RELATED PARTS

PART NUMBER	DESCRIPTION	COMMENTS
LTC1664	Quad 10-Bit V_{OUT} DAC in 16-Pin Narrow SSOP	$V_{CC} = 2.7V$ to $5.5V$, Micropower, Rail-to-Rail Output
LTC1821	Single 16-Bit V_{OUT} DAC with $\pm 1LSB$ INL, DNL	Parallel Interface, Precision 16-Bit Settling in $2\mu s$ for 10V Step
LTC2600/LTC2610/ LTC2620	Octal 16-/14-/12-Bit V_{OUT} DACs in 16-Lead Narrow SSOP	$250\mu A$ per DAC, 2.5V to 5.5V Supply Range, Rail-to-Rail Output, SPI Serial Interface
LTC2601/LTC2611/ LTC2621	Single 16-/14-/12-Bit V_{OUT} DACs in 10-Lead DFN	$300\mu A$ per DAC, 2.5V to 5.5V Supply Range, Rail-to-Rail Output, SPI Serial Interface
LTC2602/LTC2612/ LTC2622	Dual 16-/14-/12-Bit V_{OUT} DACs in 8-Lead MSOP	$300\mu A$ per DAC, 2.5V to 5.5V Supply Range, Rail-to-Rail Output, SPI Serial Interface
LTC2604/LTC2614/ LTC2624	Quad 16-/14-/12-Bit V_{OUT} DACs in 16-Lead SSOP	$250\mu A$ per DAC, 2.5V to 5.5V Supply Range, Rail-to-Rail Output, SPI Serial Interface
LTC2605/LTC2615/ LTC2625	Octal 16-/14-/12-Bit V_{OUT} DACs with I^2C Interface	$250\mu A$ per DAC, 2.7V to 5.5V Supply Range, Rail-to-Rail Output
LTC2606/LTC2616/ LTC2626	Single 16-/14-/12-Bit V_{OUT} DACs with I^2C Interface	$270\mu A$ per DAC, 2.7V to 5.5V Supply Range, Rail-to-Rail Output
LTC2609/LTC2619/ LTC2629	Quad 16-/14-/12-Bit V_{OUT} DACs with I^2C Interface	$250\mu A$ per DAC, 2.7V to 5.5V Supply Range, Rail-to-Rail Output with Separate V_{REF} Pins for Each DAC
LTC2637	Octal I^2C 12-/10-/8-Bit V_{OUT} DACs with 10ppm/ $^{\circ}C$ Reference	$125\mu A$ per DAC, 2.7V to 5.5V Supply Range, Internal 1.25V or 2.048V Reference, Rail-to-Rail Output, I^2C Interface
LTC2641/LTC2642	Single 16-/14-/12-Bit V_{OUT} DACs with $\pm 1LSB$ INL, DNL	$\pm 1LSB$ (Max) INL, DNL, $3mm \times 3mm$ DFN and MSOP Packages, $120\mu A$ Supply Current, SPI Interface
LTC2704	Quad 16-/14-/12-Bit V_{OUT} DACs with $\pm 2LSB$ INL, $\pm 1LSB$ DNL	Software Programmable Output Ranges Up to $\pm 10V$, SPI Interface
LTC2754	Quad 16-/14-/12-Bit I_{OUT} DACs with $\pm 1LSB$ INL, $\pm 1LSB$ DNL	Software Programmable Output Ranges Up to $\pm 10V$, SPI Interface
LTC2656	Octal 16-/12-Bit V_{OUT} DACs with $\pm 4LSB$ INL, $\pm 1LSB$ DNL	$4mm \times 5mm$ QFN-20, TSSOP-20 Packages, SPI Packages, Internal 10ppm/ $^{\circ}C$ (Max) Reference



Компания «ЭлектроПласт» предлагает заключение долгосрочных отношений при поставках импортных электронных компонентов на взаимовыгодных условиях!

Наши преимущества:

- Оперативные поставки широкого спектра электронных компонентов отечественного и импортного производства напрямую от производителей и с крупнейших мировых складов;
- Поставка более 17-ти миллионов наименований электронных компонентов;
- Поставка сложных, дефицитных, либо снятых с производства позиций;
- Оперативные сроки поставки под заказ (от 5 рабочих дней);
- Экспресс доставка в любую точку России;
- Техническая поддержка проекта, помощь в подборе аналогов, поставка прототипов;
- Система менеджмента качества сертифицирована по Международному стандарту ISO 9001;
- Лицензия ФСБ на осуществление работ с использованием сведений, составляющих государственную тайну;
- Поставка специализированных компонентов (Xilinx, Altera, Analog Devices, Intersil, Interpoint, Microsemi, Aeroflex, Peregrine, Syfer, Eurofarad, Texas Instrument, Miteq, Cobham, E2V, MA-COM, Hittite, Mini-Circuits, General Dynamics и др.);

Помимо этого, одним из направлений компании «ЭлектроПласт» является направление «Источники питания». Мы предлагаем Вам помощь Конструкторского отдела:

- Подбор оптимального решения, техническое обоснование при выборе компонента;
- Подбор аналогов;
- Консультации по применению компонента;
- Поставка образцов и прототипов;
- Техническая поддержка проекта;
- Защита от снятия компонента с производства.



Как с нами связаться

Телефон: 8 (812) 309 58 32 (многоканальный)

Факс: 8 (812) 320-02-42

Электронная почта: org@eplast1.ru

Адрес: 198099, г. Санкт-Петербург, ул. Калинина, дом 2, корпус 4, литера А.