

Product Description

Qorvo's TGP2109-SM is a packaged 6-bit digital phase shifter fabricated on Qorvo's high performance 0.15µm GaAs pHEMT process. It operates over 8 to 12 GHz and provides 360° of phase coverage with a LSB of 5.625°. It also achieves a low RMS phase error of 4° with 6 dB of insertion loss.

The TGP2109-SM was developed for simple system integration. It uses positive only switch logic eliminating the need for a negative voltage rail. In addition, both ports are matched to 50 ohms with DC blocking capacitors. Ease of use along with low insertion loss and a high degree of resolution makes the TGP2109-SM ideally suited for a variety of x-band phased array applications including commercial and military radars and phase array communication systems.

The device is lead-free and RoHS compliant.

Product Features

- Frequency Range: 8 to 12 GHz
- 6-Bit Digital Phase Shifter
- Bi-Directional
- 360° Coverage, LSB = 5.625°
- RMS Phase Error: 4°
- RMS Amplitude Error: 0.5 dB
- Insertion Loss: 6 dB
- Return Loss: 10 dB IRL; 15 dB ORL
- Input P1dB: 29 dBm
- Input IP3: >40 dBm
- IM3: <-50 dBc
- Control Voltage: VL: 0V to +0.2V, VH: +3V to +5V
- QFN Package Dimensions: 4.0 x 4.0 x 1.64 mm

Performance is typical across frequency. Please reference electrical specification table and data plots for more details.

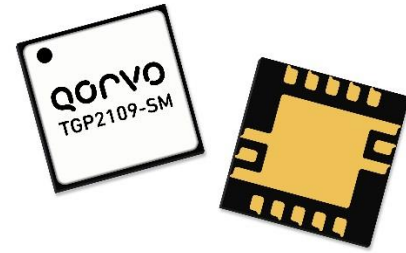

QFN 4x4 mm 16L

Functional Block Diagram

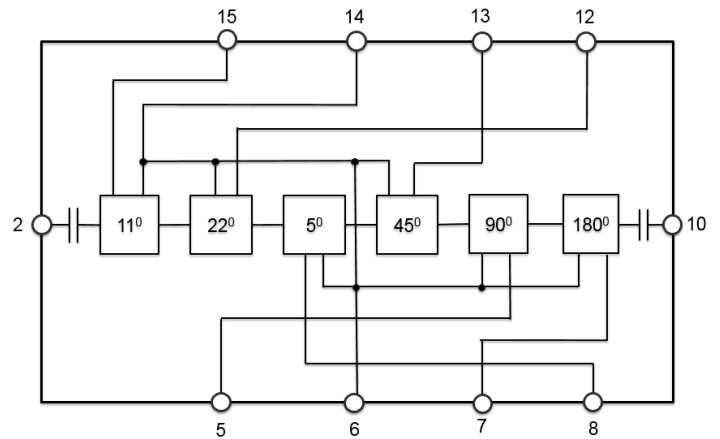

Applications

- X-Band Radar
- Satellite Communication Systems

Ordering Information

Part No.	Description
TGP2109-SM	8-12 GHz 6-Bit Digital Phase Shifter
TGP2109-SM EVB	TGP2109-SM Evaluation Board



TGP2109-SM

8 - 12 GHz 6-Bit Digital Phase Shifter

Absolute Maximum Ratings

Parameter	Value
Control and Reference Voltage	6 V
Control Current	0.5 mA
Power Dissipation	1.5 W
Input Power, CW, 50 Ω, 85°C	33 dBm
Channel Temperature	200 °C
Mounting Temperature (30 Seconds)	260 °C
Storage Temperature	-55 to 150 °C

Operation of this device outside the parameter ranges given above may cause permanent damage. These are stress ratings only, and functional operation of the device at these conditions is not implied. Extended application of Absolute Maximum Rating conditions may reduce device reliability.

Recommended Operating Conditions

Parameter	Value
Control Voltage VH	+3 V to +5 V
Control Voltage VL	0 V to +0.2 V
Control Current (Total)	< 100 μA
Temperature Range	-40 to +85 °C

Electrical specifications are measured at specified test conditions. Specifications are not guaranteed overall operating conditions.

Electrical Specifications

Test conditions unless otherwise noted: 25°C. Control Voltage: VL = 0 V, VH = +5 V, see Bias Truth Table.

Parameter	Min	Typical	Max	Units
Operational Frequency Range	8		12	GHz
Insertion Loss		6		dB
Input Return Loss		10		dB
Output Return Loss		15		dB
RMS Phase Error		4		deg
RMS Amplitude Error		0.5		dB
Input P1dB		29		dBm
Input IP3 (Tone Spacing = 10 MHz, Pin/Tone = 16 dBm)		> 40		dBm
IM3 (Tone Spacing = 10 MHz, Pin/Tone = 16 dBm)		< -50		dBc
Insertion Loss Temperature Coefficient		0.004		dB/°C

Bias Truth Table

Logic "0" = VL, value from 0 to +0.2 V; Logic "1" = VH = VREF, value from +3 V to +5 V

Phase Shifter	B1	B2	B3	B4	B5	B6	VREF
0° (Reference)	0	0	1	1	1	1	1
5°	1	0	1	1	1	1	1
11°	0	1	1	1	1	1	1
22°	0	0	0	1	1	1	1
45°	0	0	1	0	1	1	1
90°	0	0	1	1	0	1	1
180°	0	0	1	1	1	0	1
355°	1	1	0	0	0	0	1

Performance Plots – Small Signal

Test conditions unless otherwise noted: 25 °C. Data de-embedded to device reference planes

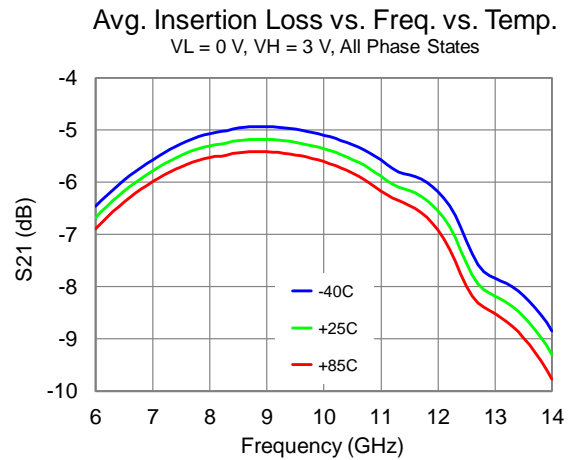
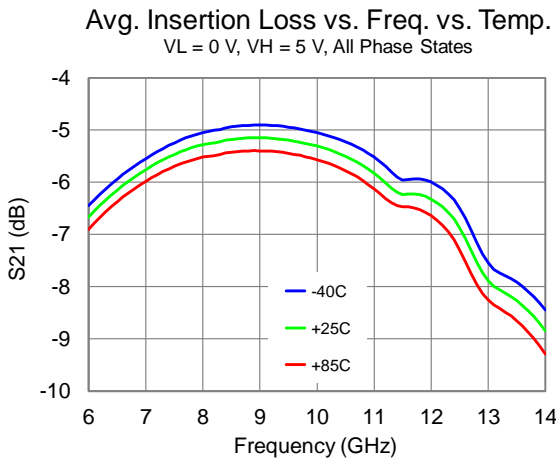
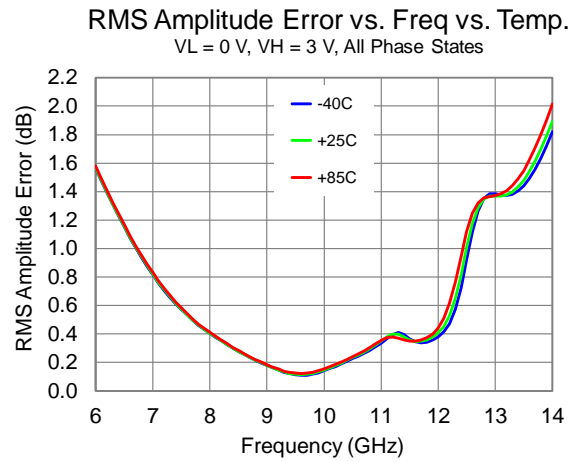
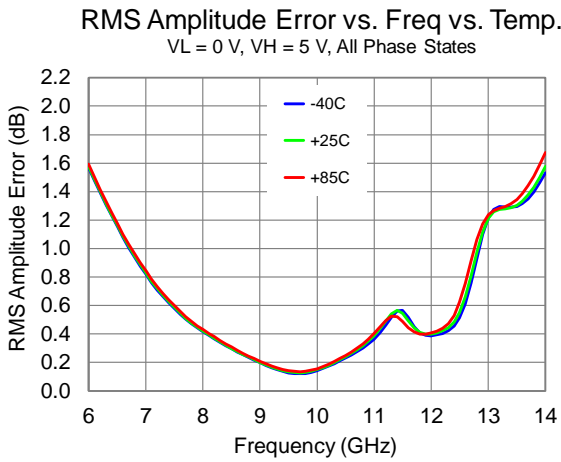
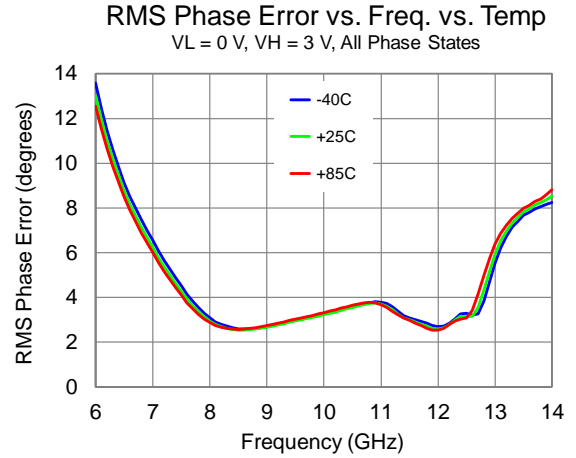
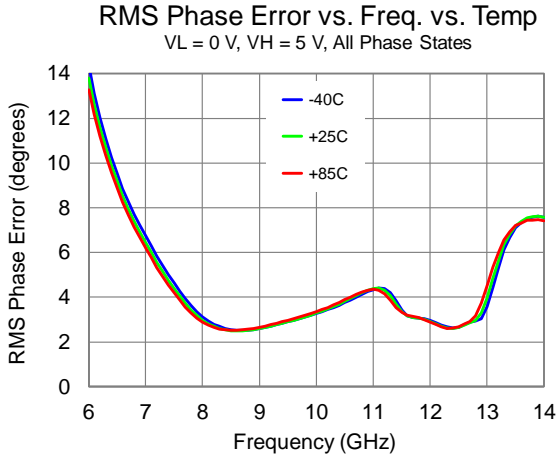

Performance Plots – Small Signal

Test conditions unless otherwise noted: 25 °C. Data de-embedded to device reference planes

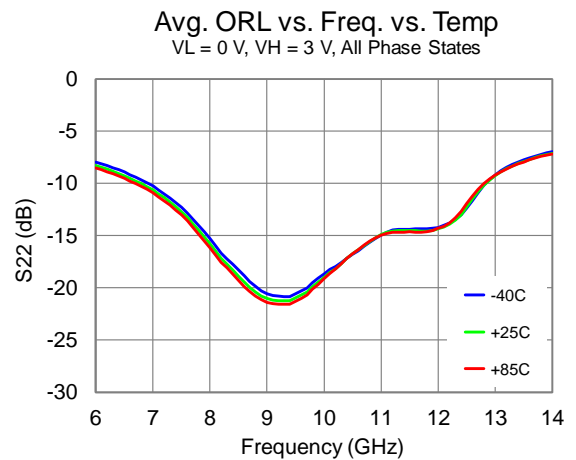
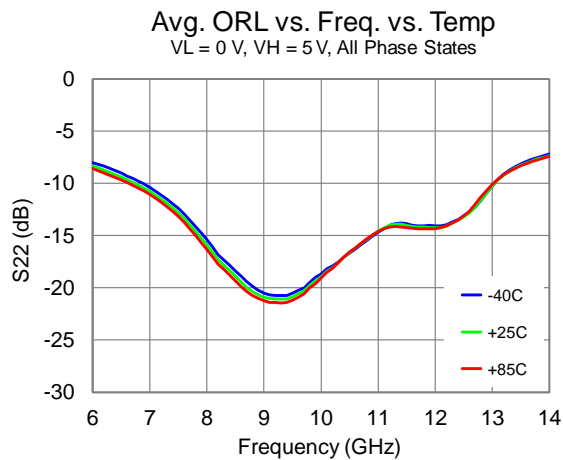
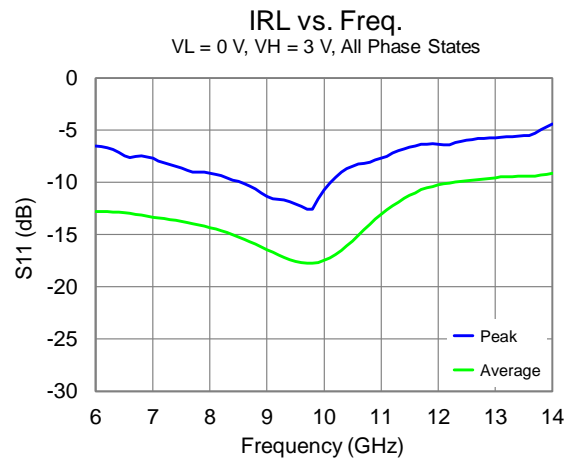
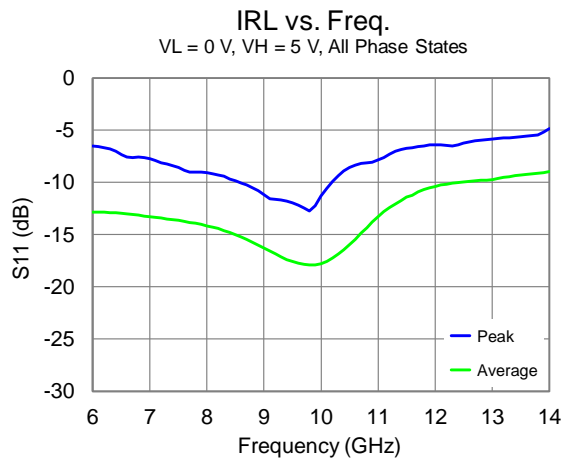
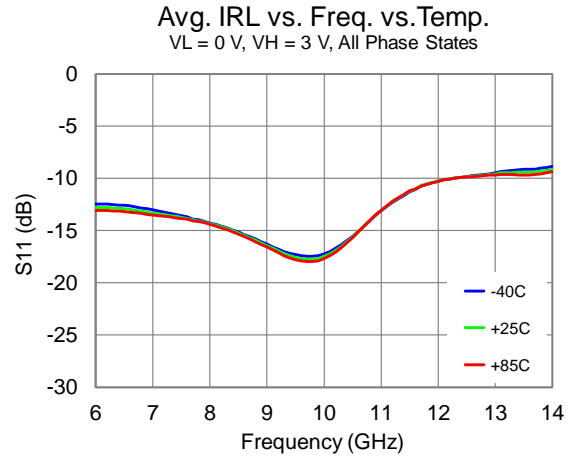
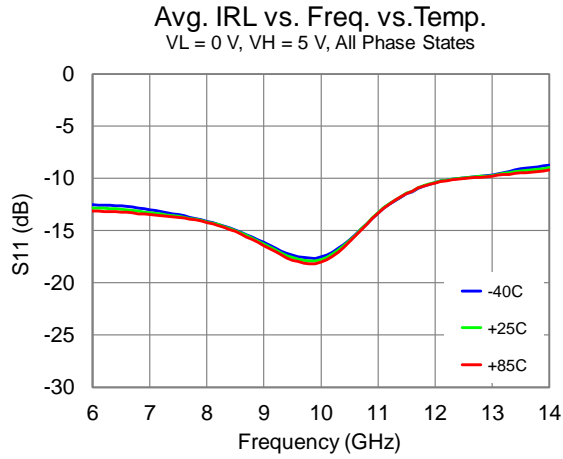

Performance Plots – Small Signal

Test conditions unless otherwise noted: 25 °C. Data de-embedded to device reference planes

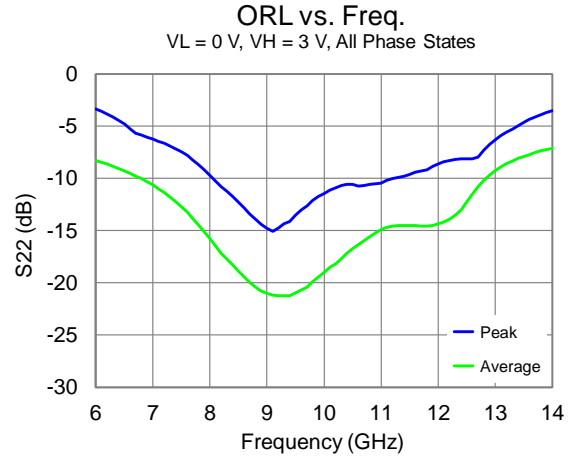
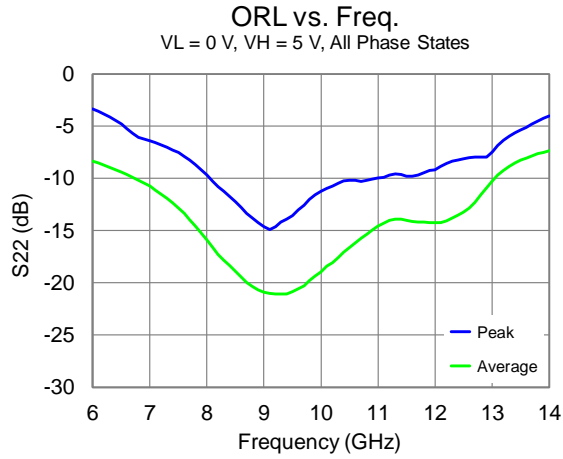

Performance Plots – Large Signal

Test conditions unless otherwise noted: Freq = 10 GHz, 25 °C. Data de-embedded to device reference planes

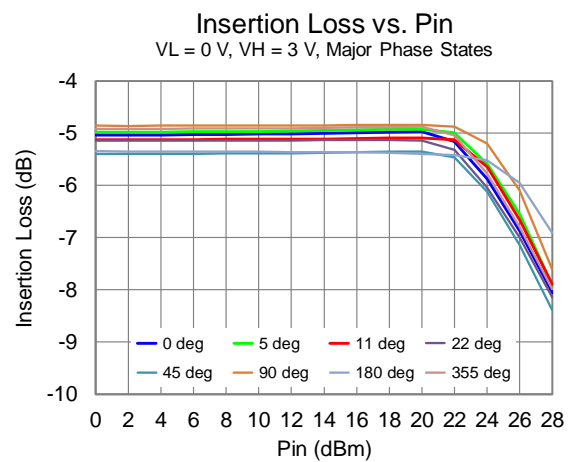
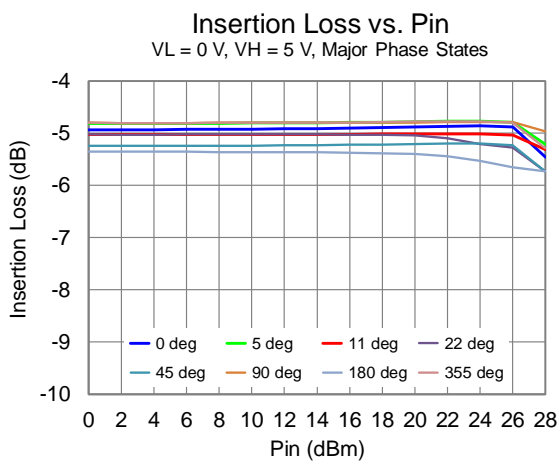
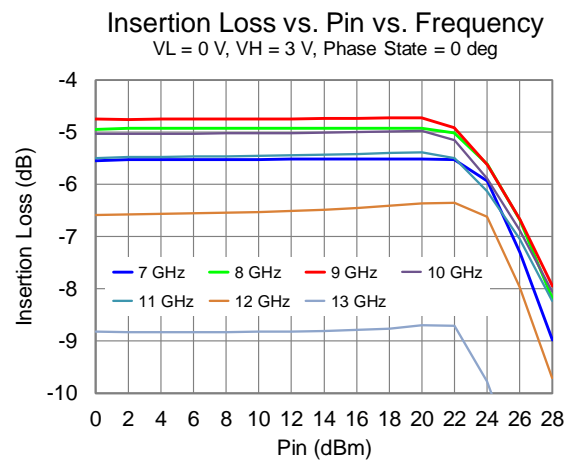
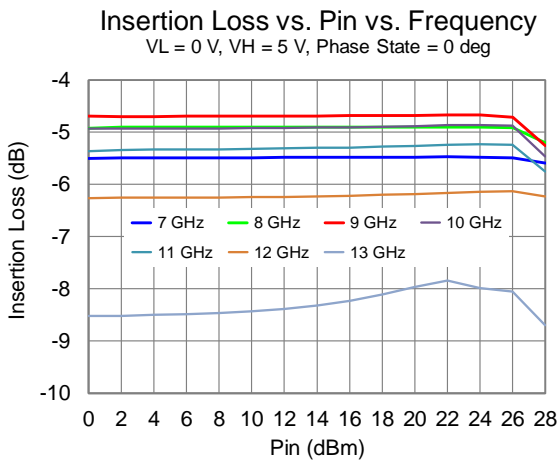
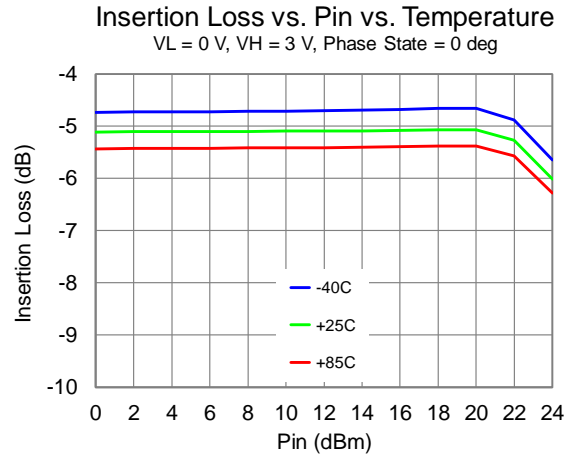
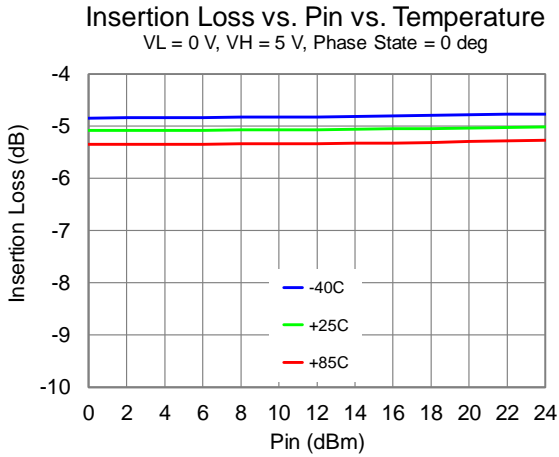

Performance Plots – Large Signal

Test conditions unless otherwise noted: Freq = 10 GHz, 25 °C. Data de-embedded to device reference planes

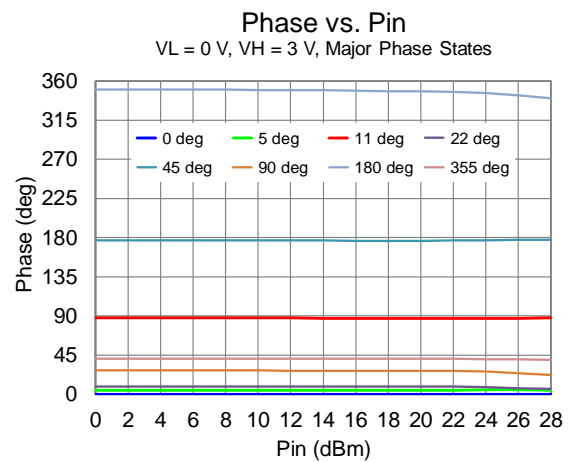
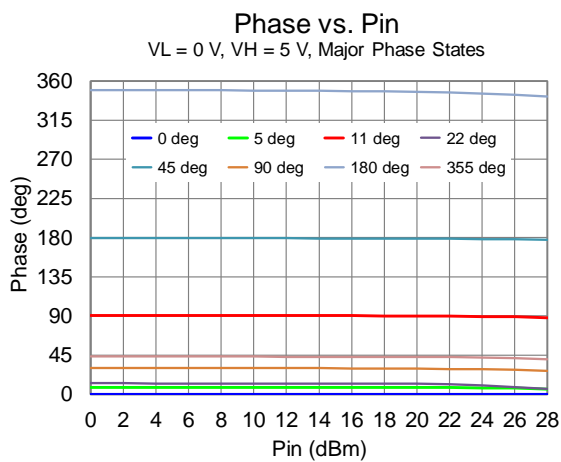
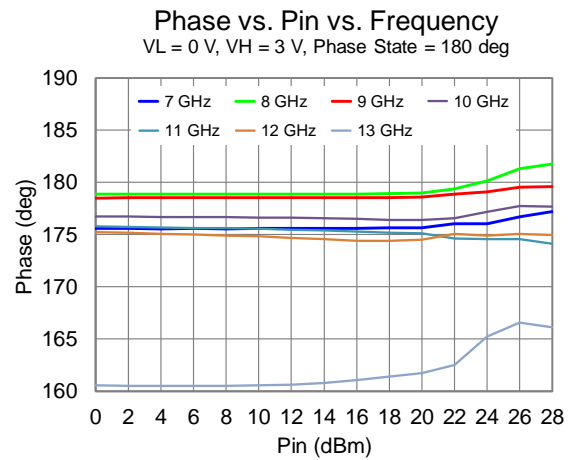
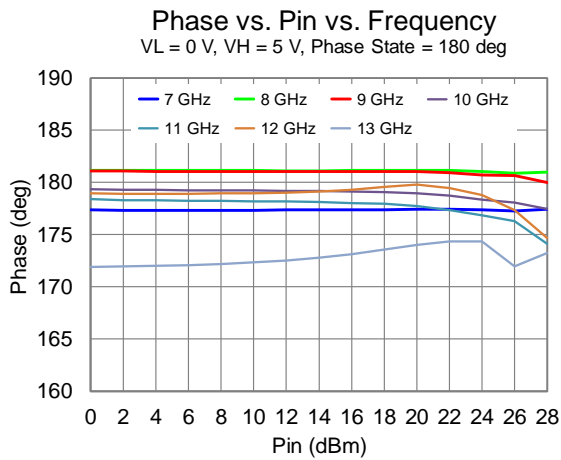
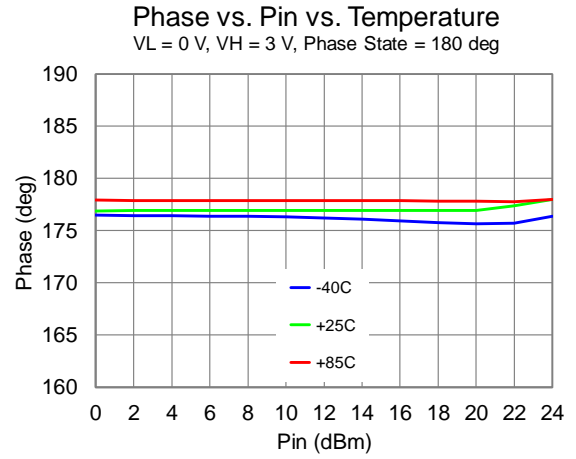
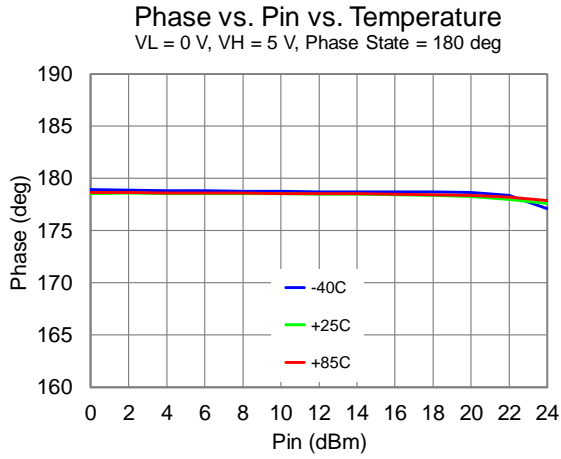

Performance Plots – Large Signal

Test conditions unless otherwise noted: Total current of VH, Freq = 10 GHz, 25 °C

Control Current vs. Pin vs. Temperature

VL = 0 V, VH = 5 V, Phase State = 0 deg

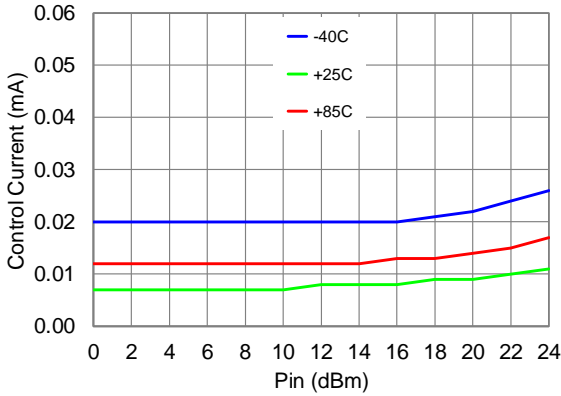

Control Current vs. Pin vs. Temperature

VL = 0 V, VH = 3 V, Phase State = 0 deg

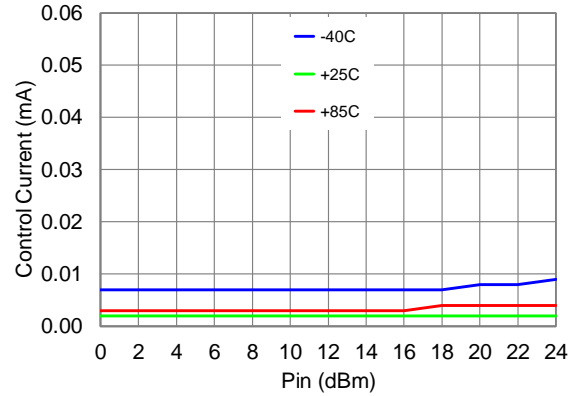

Control Current vs. Pin vs. Frequency

VL = 0 V, VH = 5 V, Phase State = 0 deg

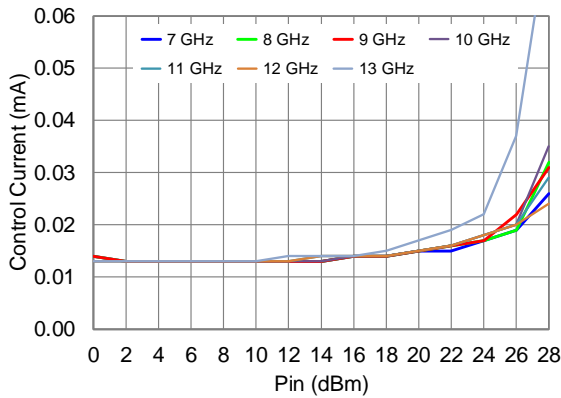

Control Current vs. Pin vs. Frequency

VL = 0 V, VH = 3 V, Phase State = 0 deg

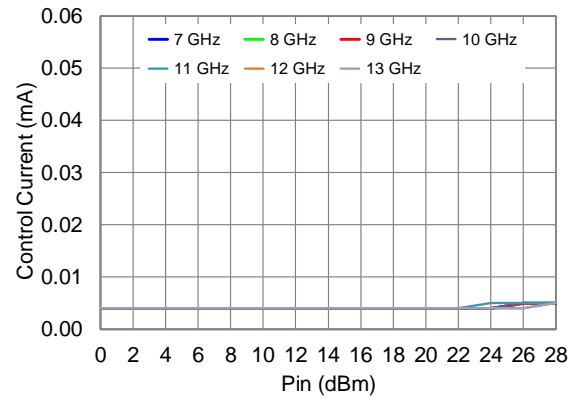

Control Current vs. Pin vs. Phase States

VL = 0 V, VH = 5 V

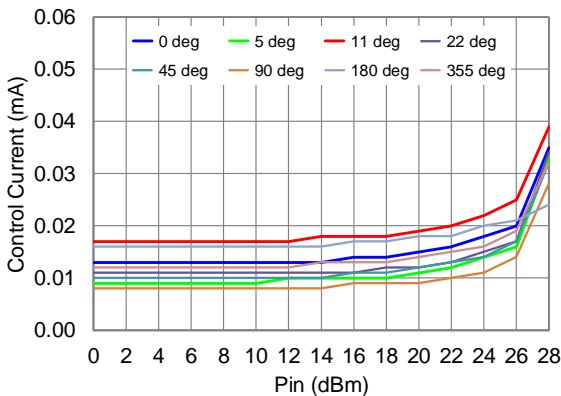

Control Current vs. Pin vs Phase States

VL = 0 V, VH = 3 V

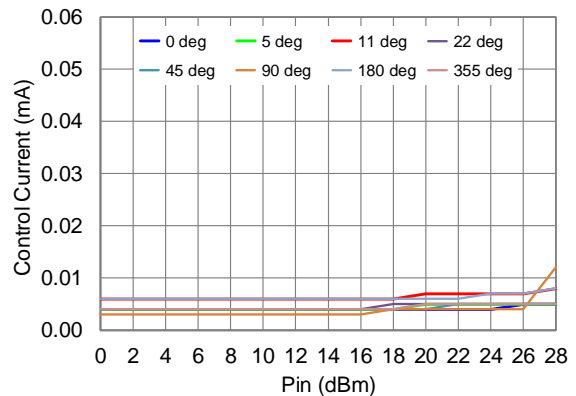

Performance Plots – Linearity

Test conditions unless otherwise noted: Tone Spacing = 10 MHz, 25 °C. Data de-embedded to device reference planes

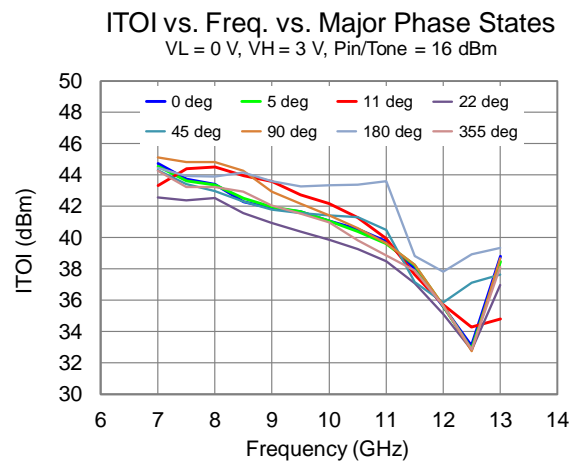
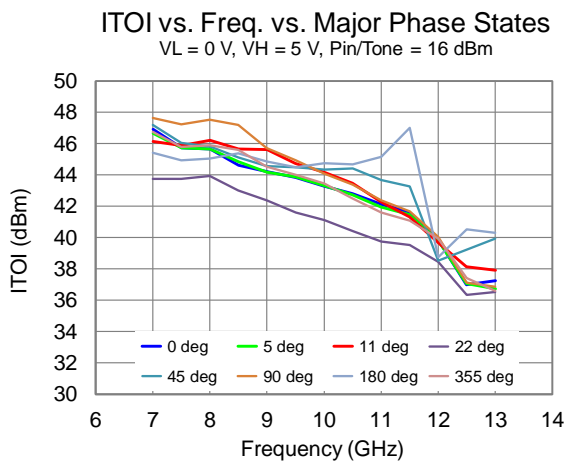
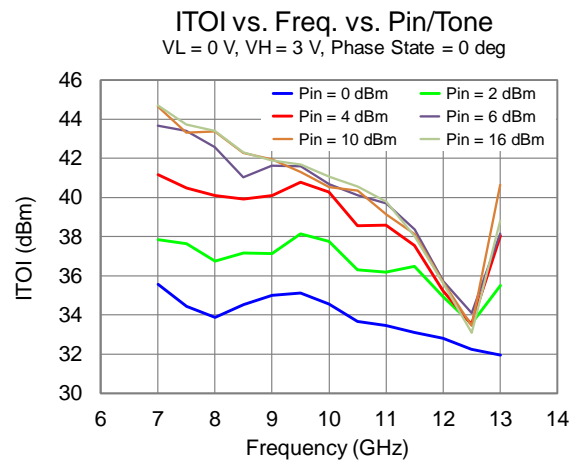
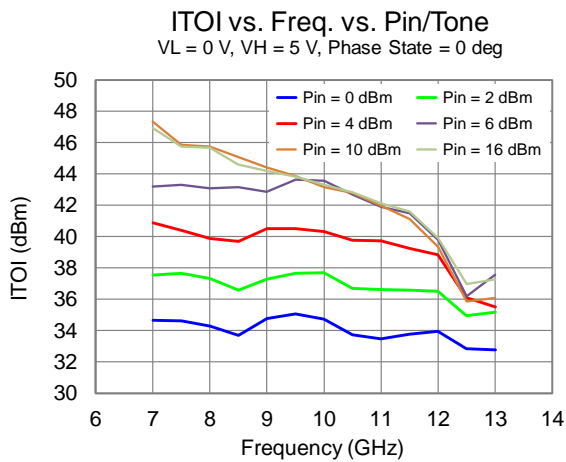
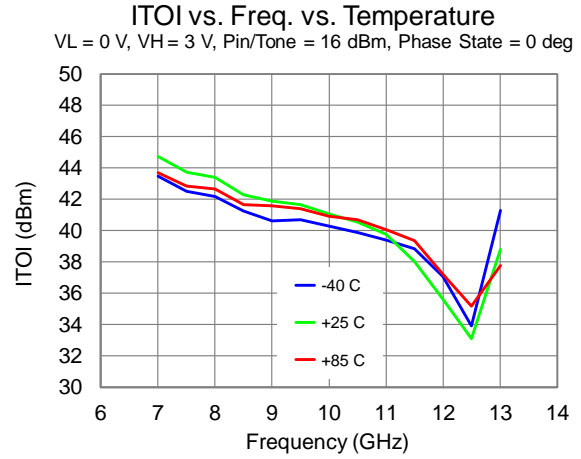
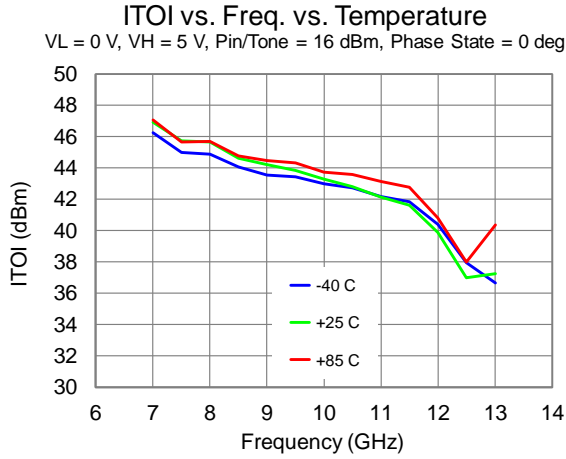

Performance Plots – Linearity

Test conditions unless otherwise noted: Tone Spacing = 10 MHz, 25 °C. Data de-embedded to device reference planes

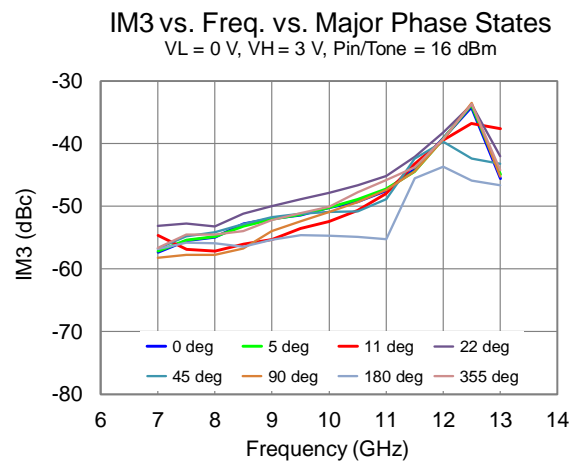
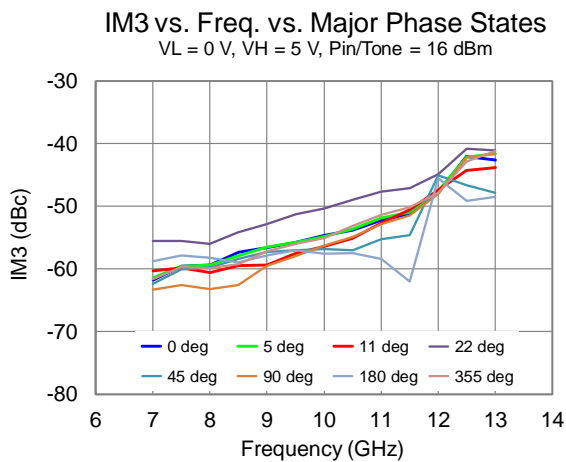
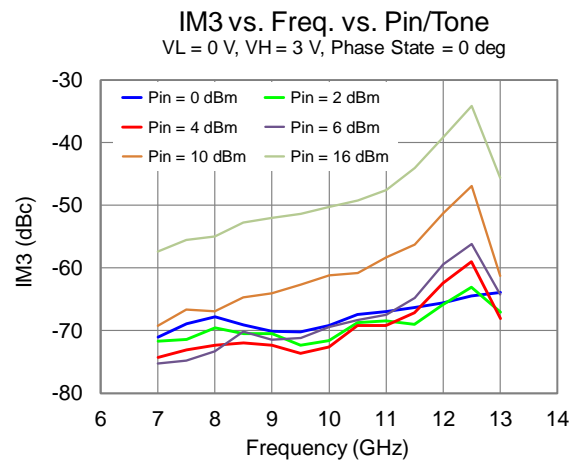
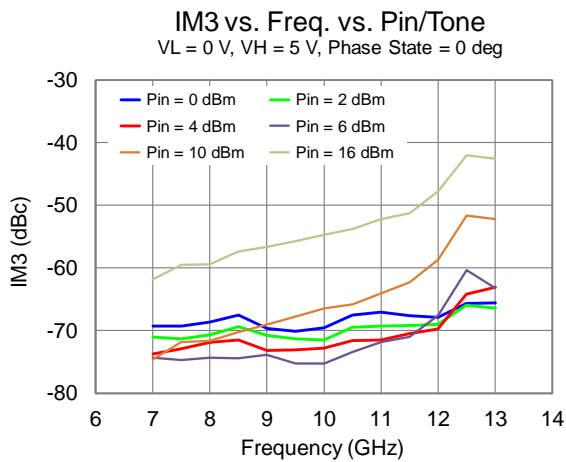
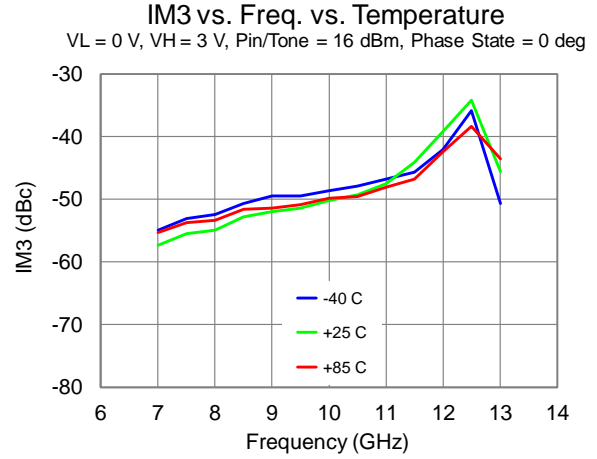
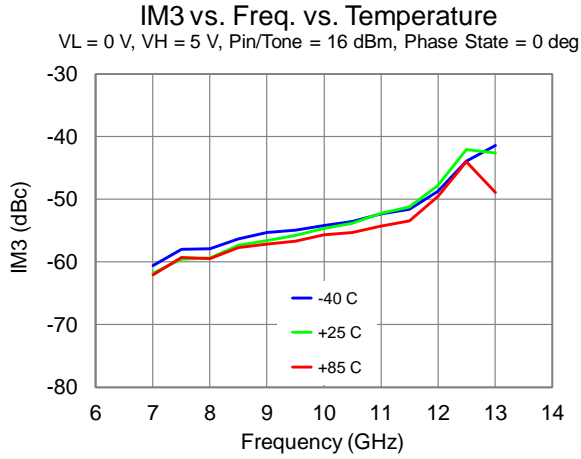

Package Pin Descriptions

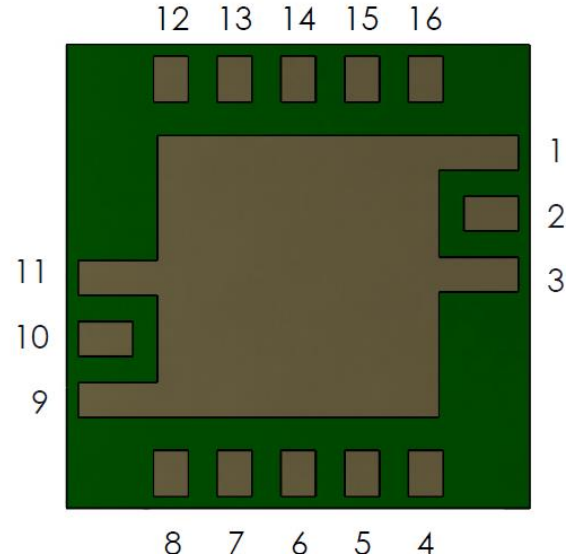

Package Pad	Symbol	Description
1, 3, 9, 11	GND	Internal grounding; must be grounded on PCB
2	RF Input	Input; matched to 50 Ohms; DC blocked; interchangeable to RF Output
4, 16	N/C	No Connection; recommend GND at the EVB level
5	B5	90° Bit
6, 14	REF	Reference; VREF can be biased to either side of the package
7	B6	180° Bit
8	B1	5° Bit
10	RF Output	Output; matched to 50 Ohms; DC blocked; interchangeable to RF Input
12	B3	22° Bit
13	B4	45° Bit
15	B2	11° Bit
17 (Slug)	GND	On PCB; multiple vias should be employed under the center pad (17) to minimize inductance and thermal resistance; see page 13 for suggested vias layout

Package Mechanical Drawing and Dimensions

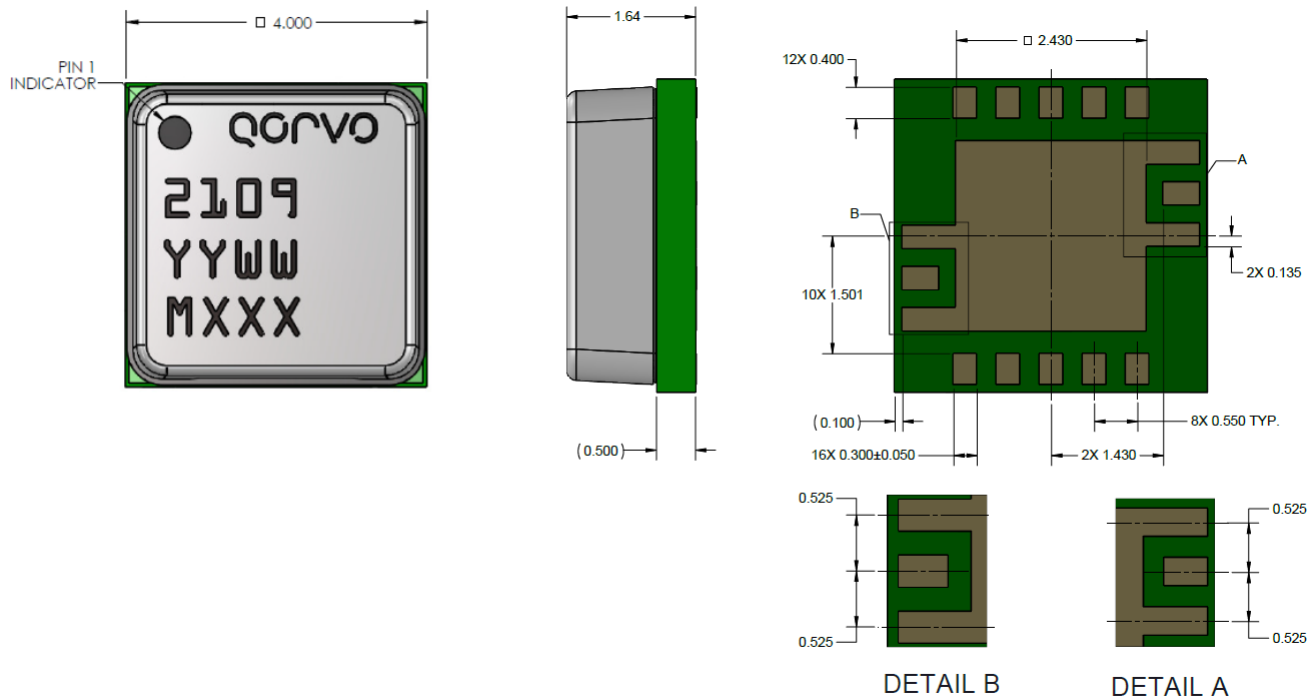

Units: mm

Tolerances: unless specified

.xx = ± 0.25

.xxx = ± 0.100

Angles = 0.5°

Materials:

Lid: Plastic

Base: Laminate

Plating: All metalized features are NiAu plated

The part is epoxy sealed

Marking:

2109: Part number

YY: Part Assembly year

WW: Part Assembly week

MXXX: Batch ID

Applications and EVB Information

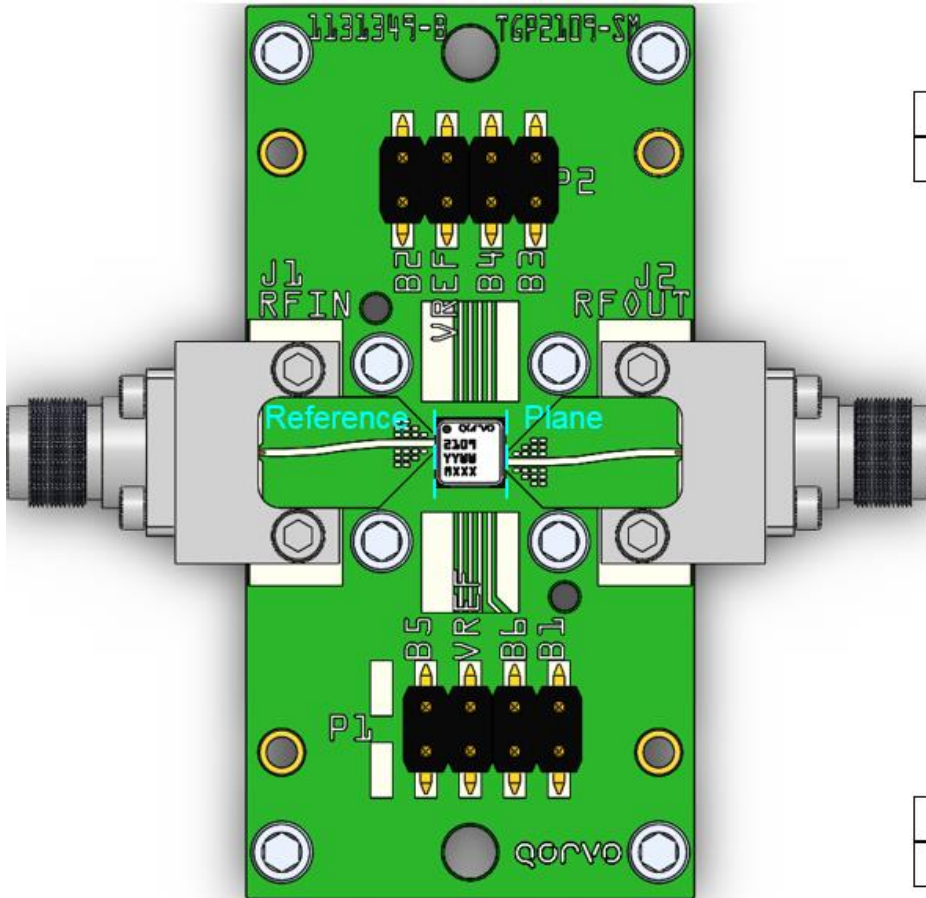

P2 Connectors (Top)

GND	GND	GND	GND
B2	VREF	B4	B3

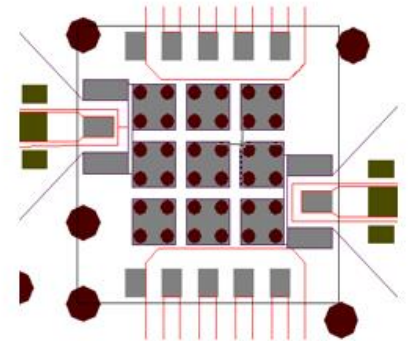

P1 Connectors (Bottom)

B5	VREF	B6	B1
GND	GND	GND	GND

RF layer is 0.008" thick Rogers RO4003C. Metal layers are 0.5-oz copper. The microstrip line taper at the connector interface is optimized for the Southwest Microwave end-launch connector 1092-02A-5.

Ground / thermal vias under the DUT are critical for the proper performance of this device. The PCB shown herein utilizes copper filled vias (8 mils diameter) under the DUT.

The pad pattern shown has been developed and tested for optimized assembly at Qorvo. The PCB land pattern has been developed to accommodate lead and package tolerances. Since surface mount processes vary from company to company, careful process development is recommended.

De-Quing network is not required; VREF can be biased to either side of the package (pin #6 or #14).

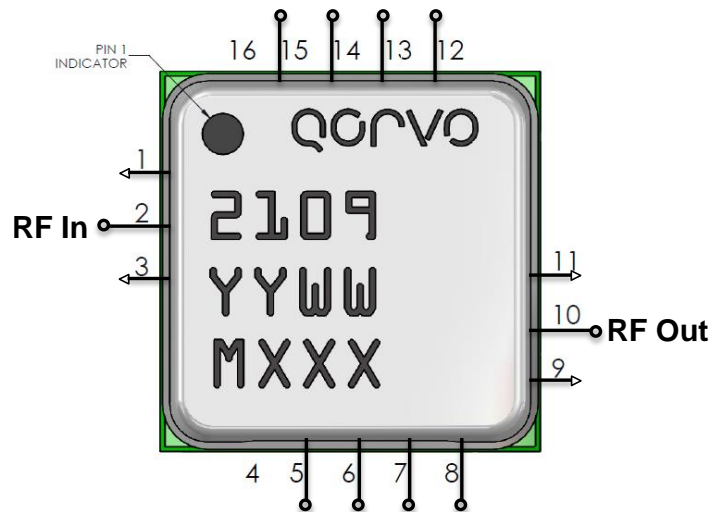

Thermal and Reliability Information

Parameter	Test Conditions	Value	Units
Channel Temperature (T_{CH})	$T_{BASE} = 85^{\circ}C$	85	$^{\circ}C$
Median Lifetime (T_M)		5.2E+9	Hrs

Notes:

- Under normal (lifetime) operating conditions, self-heating is not a significant contributor to channel temperature.

Median Lifetime

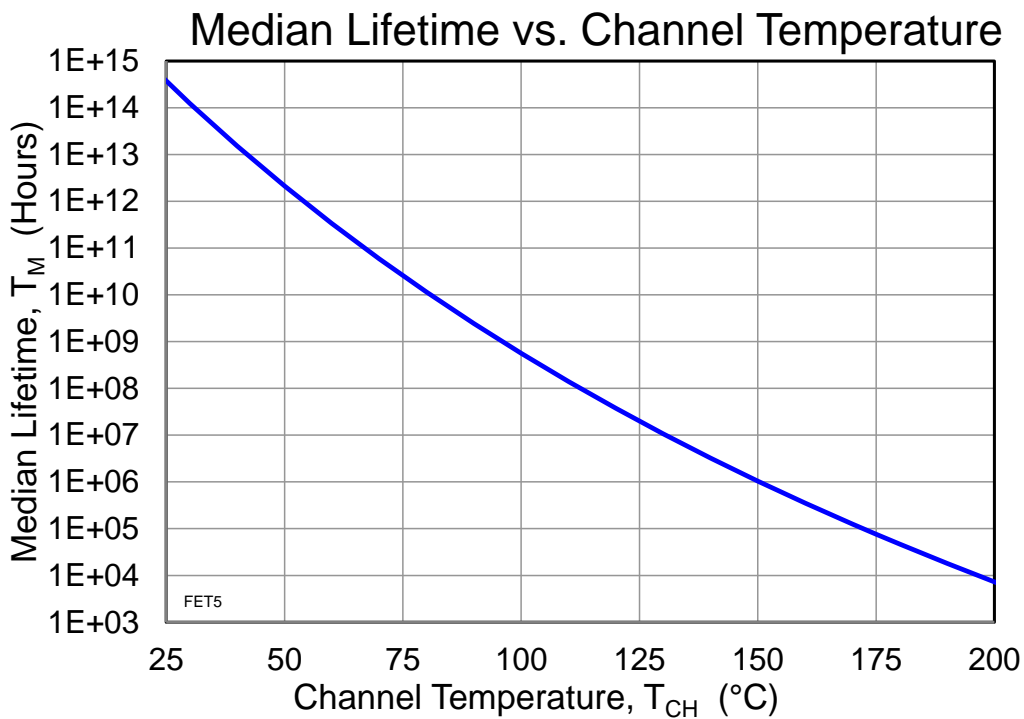

Solderability

1. Compatible with the latest version of J-STD-020, Lead-free solder, 260 °C.
2. The use of no-clean solder to avoid washing after soldering is recommended.
3. Package lead plating is NiAu.

Recommended Soldering Temperature Profile

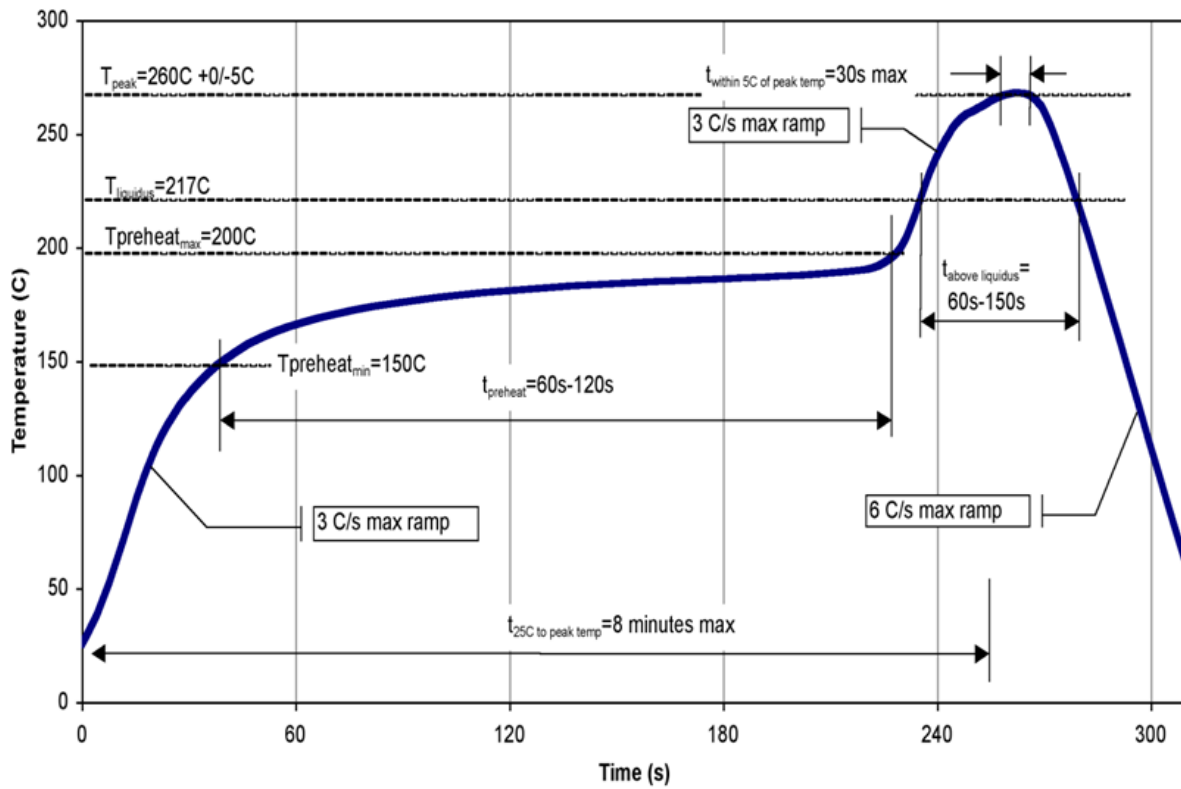

Handling Precautions

Parameter	Rating	Standard
ESD – Human Body Model (HBM)	Class 0	ESDA / JEDEC JS-001-2012
ESD – Charge Device Model (CDM)	Class C2	JS-002-2014
MSL – Moisture Sensitivity Level	Level 3	IPC/JEDEC J-STD-020



Caution!
ESD-Sensitive Device

RoHS Compliance

This product is compliant with the 2011/65/EU RoHS directive (Restrictions on the Use of Certain Hazardous Substances in Electrical and Electronic Equipment), as amended by Directive 2015/863/EU. This product also has the following attributes:

- Lead Free
- Halogen Free (Chlorine, Bromine)
- Antimony Free
- TBBP-A (C₁₅H₁₂Br₄O₂) Free
- PFOS Free

Contact Information

For the latest specifications, additional product information, worldwide sales and distribution locations:

Tel: 1-844-890-8163

Web: www.qorvo.com

Email: customer.support@qorvo.com

Important Notice

The information contained herein is believed to be reliable; however, Qorvo makes no warranties regarding the information contained herein and assumes no responsibility or liability whatsoever for the use of the information contained herein. All information contained herein is subject to change without notice. Customers should obtain and verify the latest relevant information before placing orders for Qorvo products. The information contained herein or any use of such information does not grant, explicitly or implicitly, to any party any patent rights, licenses, or any other intellectual property rights, whether with regard to such information itself or anything described by such information. **THIS INFORMATION DOES NOT CONSTITUTE A WARRANTY WITH RESPECT TO THE PRODUCTS DESCRIBED HEREIN, AND QORVO HEREBY DISCLAIMS ANY AND ALL WARRANTIES WITH RESPECT TO SUCH PRODUCTS WHETHER EXPRESS OR IMPLIED BY LAW, COURSE OF DEALING, COURSE OF PERFORMANCE, USAGE OF TRADE OR OTHERWISE, INCLUDING THE IMPLIED WARRANTIES OF MERCHANTABILITY AND FITNESS FOR A PARTICULAR PURPOSE.**

Without limiting the generality of the foregoing, Qorvo products are not warranted or authorized for use as critical components in medical, life-saving, or life-sustaining applications, or other applications where a failure would reasonably be expected to cause severe personal injury or death.

Copyright 2019 © Qorvo, Inc. | Qorvo is a registered trademark of Qorvo, Inc.



Компания «ЭлектроПласт» предлагает заключение долгосрочных отношений при поставках импортных электронных компонентов на взаимовыгодных условиях!

Наши преимущества:

- Оперативные поставки широкого спектра электронных компонентов отечественного и импортного производства напрямую от производителей и с крупнейших мировых складов;
- Поставка более 17-ти миллионов наименований электронных компонентов;
- Поставка сложных, дефицитных, либо снятых с производства позиций;
- Оперативные сроки поставки под заказ (от 5 рабочих дней);
- Экспресс доставка в любую точку России;
- Техническая поддержка проекта, помощь в подборе аналогов, поставка прототипов;
- Система менеджмента качества сертифицирована по Международному стандарту ISO 9001;
- Лицензия ФСБ на осуществление работ с использованием сведений, составляющих государственную тайну;
- Поставка специализированных компонентов (Xilinx, Altera, Analog Devices, Intersil, Interpoint, Microsemi, Aeroflex, Peregrine, Syfer, Eurofarad, Texas Instrument, Miteq, Cobham, E2V, MA-COM, Hittite, Mini-Circuits, General Dynamics и др.);

Помимо этого, одним из направлений компании «ЭлектроПласт» является направление «Источники питания». Мы предлагаем Вам помощь Конструкторского отдела:

- Подбор оптимального решения, техническое обоснование при выборе компонента;
- Подбор аналогов;
- Консультации по применению компонента;
- Поставка образцов и прототипов;
- Техническая поддержка проекта;
- Защита от снятия компонента с производства.



Как с нами связаться

Телефон: 8 (812) 309 58 32 (многоканальный)

Факс: 8 (812) 320-02-42

Электронная почта: org@eplast1.ru

Адрес: 198099, г. Санкт-Петербург, ул. Калинина, дом 2, корпус 4, литера А.