

# Series 41

## Characteristics

The rectangular design of the Series 41 (18x24 mm) makes it especially suited:

- Raised design
- PCB (with adaptor)

The series features a compact double-lit element that can be fitted from the front as a snap-on module.

## Functions

The Series 41 incorporates the following functions:

- Indicator
- Illuminated pushbutton

## Market segments

The EAO Series 41 is especially suited for applications in the segment:

- Machinery and Automation

Please refer to the EAO website to obtain detailed information regarding this series [www.products.eao.com](http://www.products.eao.com)  
Configure a product to your exact needs and request a quotation.





**Overview****Raised design**

Indicator 4

Illuminated pushbutton 5

**Accessories** 7**Drawings** 14**Technical data** 15**Marking** 17**Guidelines for use** 18**Index** 19

# 41 Raised design

## Indicator, IP 40

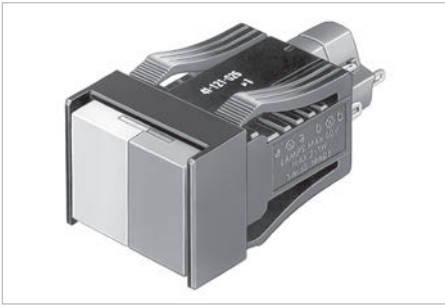

Product can differ from the current configuration.

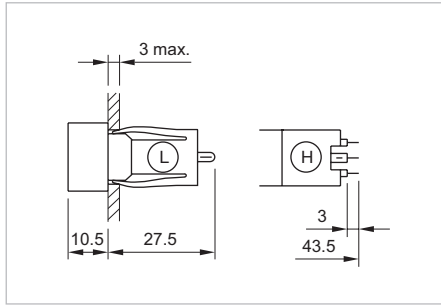

Dimensions [mm]  
 L = Solder terminal,  
 H = Universal terminal 2.0 x 0.5 mm

### Equipment consisting of (schematic overview)



**Lens**

page 7



**2 LEDs**

page 10

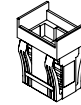



**Actuator**

Each Part Number listed below includes all the black components shown in the 3D-drawing.

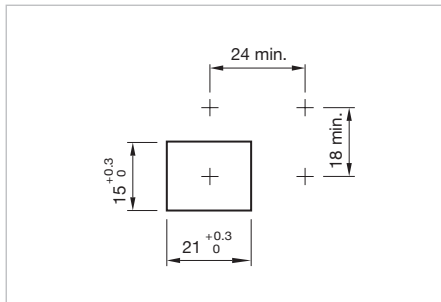
*To obtain a complete unit, please select the red components from the pages shown.*



Mounting cut-outs [mm]

| Terminal   | Part No.          | Wiring diagram | Weight   |
|--|-------------------|----------------|----------|
|  <p><b>Indicator, Front dimension 18 x 24 mm</b></p> |                   |                |          |
| Solder   | <b>41-040.005</b> | 1              | 0.009 kg |
|  <p><b>Indicator, Front dimension 18 x 24 mm</b></p> |                   |                |          |
| Universal 2.0 x 0.5 mm   | <b>41-041.006</b> | 1              | 0.009 kg |

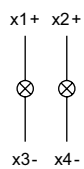

Wiring diagram 1

## Illuminated pushbutton, IP 40

### Equipment consisting of (schematic overview)

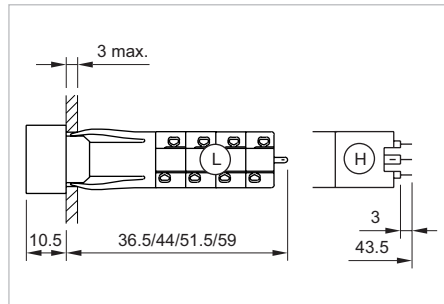
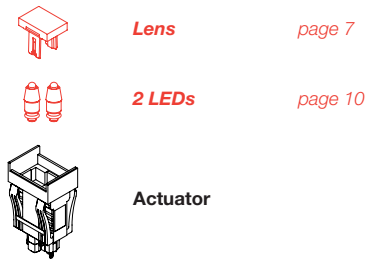

Product can differ from the current configuration.



Each Part Number listed below includes all the black components shown in the 3D-drawing.

To obtain a complete unit, please select the red components from the pages shown.

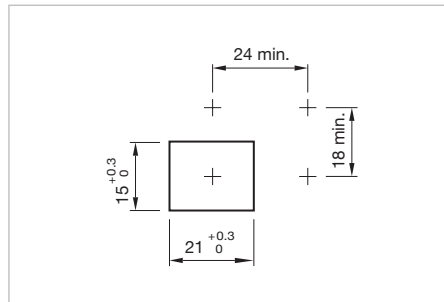
Dimensions [mm]  
L = Solder terminal,  
H = Universal terminal 2.0 x 0.5 mm



Mounting cut-outs [mm]

| Switching system   | Contacts    | Switching action | Terminal               | Part No.           | Wiring diagram | Weight   |
|--|-------------|------------------|------------------------|--------------------|----------------|----------|
|  <p><b>Illuminated pushbutton, Front dimension 18 x 24 mm</b></p> |             |                  |                        |                    |                |          |
| Snap-action switching element  | 1 NC + 1 NO | B                | Solder                 | <b>41-121.0252</b> | 1              | 0.011 kg |
|  |             | C                | Solder                 | <b>41-261.0252</b> | 2              | 0.011 kg |
|  | 2 NC + 2 NO | B                | Solder                 | <b>41-122.0252</b> | 3              | 0.012 kg |
|  |             | C                | Solder                 | <b>41-262.0252</b> | 4              | 0.013 kg |
|  | 3 NC + 3 NO | B                | Solder                 | <b>41-123.0252</b> | 5              | 0.014 kg |
|  |             | C                | Solder                 | <b>41-263.0252</b> | 6              | 0.014 kg |
|  | 4 NC + 4 NO | B                | Solder                 | <b>41-124.0252</b> | 7              | 0.015 kg |
|  |             | C                | Solder                 | <b>41-264.0252</b> | 8              | 0.015 kg |
|  <p><b>Illuminated pushbutton, Front dimension 18 x 24 mm</b></p> |             |                  |                        |                    |                |          |
| Low-level element  | 2 NO        | B                | Universal 2.0 x 0.5 mm | <b>41-421.036</b>  | 9              | 0.014 kg |
|  |             | C                | Universal 2.0 x 0.5 mm | <b>41-461.036</b>  | 10             | 0.014 kg |
|  | 2 NC        | B                | Universal 2.0 x 0.5 mm | <b>41-422.036</b>  | 11             | 0.014 kg |
|  |             | C                | Universal 2.0 x 0.5 mm | <b>41-462.036</b>  | 12             | 0.014 kg |
|  | 1 NC + 1 NO | B                | Universal 2.0 x 0.5 mm | <b>41-423.036</b>  | 13             | 0.014 kg |
|  |             | C                | Universal 2.0 x 0.5 mm | <b>41-463.036</b>  | 14             | 0.014 kg |

Contacts: NC = Normally closed, NO = Normally open  
Switching action: B = Momentary, C = Maintained

# 41 Raised design

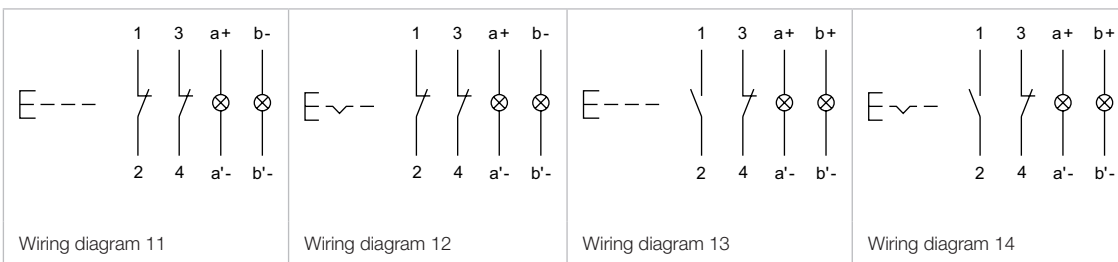

Front

Lens plastic single-colour

| Product attribute  | Dimension      | Lens                   | Part No.        | Weight   |
|--|----------------|------------------------|-----------------|----------|
|  <p><b>Lens plastic single-colour</b></p> |                |                        |                 |          |
| flat, illuminative   | 15.3 x 21.5 mm | red transparent        | <b>41-903.2</b> | 0.001 kg |
|  |                | orange transparent     | <b>41-903.3</b> | 0.001 kg |
|  |                | yellow transparent     | <b>41-903.4</b> | 0.001 kg |
|  |                | green transparent      | <b>41-903.5</b> | 0.001 kg |
|  |                | blue transparent       | <b>41-903.6</b> | 0.001 kg |
|  |                | colourless transparent | <b>41-903.7</b> | 0.001 kg |
| flat, illuminative, less suitable for film insert  | 15.3 x 21.5 mm | red transparent        | <b>41-904.2</b> | 0.001 kg |
|  |                | orange transparent     | <b>41-904.3</b> | 0.001 kg |
|  |                | yellow transparent     | <b>41-904.4</b> | 0.001 kg |
|  |                | green transparent      | <b>41-904.5</b> | 0.001 kg |
|  |                | colourless transparent | <b>41-904.7</b> | 0.001 kg |

Lens plastic bi-colour

| Product attribute  | Dimension      | Lens                              | Part No.          | Weight   |
|--|----------------|-----------------------------------|-------------------|----------|
|  <p><b>Lens plastic bi-colour</b></p> |                |                                   |                   |          |
| flat, illuminative   | 15.3 x 21.5 mm | red-orange transparent            | <b>41-907.2/3</b> | 0.002 kg |
|  |                | red-yellow transparent            | <b>41-907.2/4</b> | 0.002 kg |
|  |                | red-green transparent             | <b>41-907.2/5</b> | 0.002 kg |
|  |                | red-blue transparent              | <b>41-907.2/6</b> | 0.002 kg |
|  |                | red-colourless transparent        | <b>41-907.2/7</b> | 0.002 kg |
|  |                | orange-green transparent          | <b>41-907.3/5</b> | 0.002 kg |
|  |                | orange-blue transparent           | <b>41-907.3/6</b> | 0.002 kg |
|  |                | orange-colourless transparent     | <b>41-907.3/7</b> | 0.002 kg |
|  |                | yellow-green transparent          | <b>41-907.4/5</b> | 0.002 kg |
|  |                | yellow-blue transparent           | <b>41-907.4/6</b> | 0.002 kg |
|  |                | yellow-colourless transparent     | <b>41-907.4/7</b> | 0.002 kg |
|  |                | green-blue transparent            | <b>41-907.5/6</b> | 0.002 kg |
|  |                | green-colourless transparent      | <b>41-907.5/7</b> | 0.002 kg |
|  |                | blue-colourless transparent       | <b>41-907.6/7</b> | 0.002 kg |
|  |                | colourless-colourless transparent | <b>41-907.7/7</b> | 0.002 kg |
| flat, illuminative, less suitable for film insert  | 15.3 x 21.5 mm | red-orange transparent            | <b>41-908.2/3</b> | 0.002 kg |
|  |                | red-yellow transparent            | <b>41-908.2/4</b> | 0.002 kg |
|  |                | red-green transparent             | <b>41-908.2/5</b> | 0.002 kg |
|  |                | red-colourless transparent        | <b>41-908.2/7</b> | 0.002 kg |
|  |                | orange-yellow transparent         | <b>41-908.3/4</b> | 0.002 kg |
|  |                | orange-green transparent          | <b>41-908.3/5</b> | 0.002 kg |

# 41 Accessories

| Product attribute                                 | Dimension      | Lens                              | Part No.          | Weight   |
|---|----------------|-----------------------------------|-------------------|----------|
| flat, illuminative, less suitable for film insert | 15.3 x 21.5 mm | orange-colourless transparent     | <b>41-908.3/7</b> | 0.002 kg |
|   |                | yellow-green transparent          | <b>41-908.4/5</b> | 0.002 kg |
|   |                | yellow-colourless transparent     | <b>41-908.4/7</b> | 0.002 kg |
|   |                | green-colourless transparent      | <b>41-908.5/7</b> | 0.002 kg |
|   |                | colourless-colourless transparent | <b>41-908.7/7</b> | 0.002 kg |

## Protective cover, IP 40

### Additional Information

- Hinged, with means for sealing
- Front panel thickness reduces by 2 mm
- Please note that bigger minimum distances are necessary

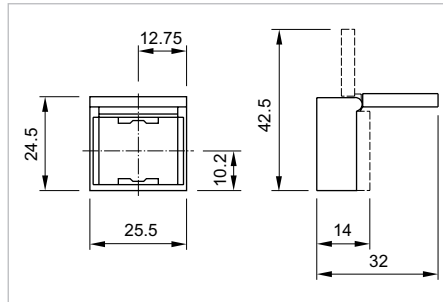

Dimensions [mm]

| Product attribute  | Dimension  | Material | Optics      | Part No.      | Weight   |
|--|------------|----------|-------------|---------------|----------|
|  <p><b>Protective cover</b></p> |            |          |             |               |          |
| for button with front dimension 15 x 21 mm   | 18 x 24 mm | Plastic  | transparent | <b>41-925</b> | 0.002 kg |

## Blind plug

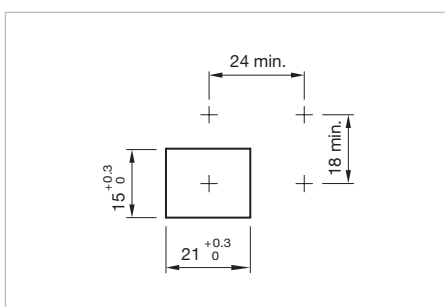

Einbauöffnungen [mm]

| Dimension  | Material | Colour | Part No.        | Weight   |
|--|----------|--------|-----------------|----------|
|  <p><b>Blind plug</b></p> |          |        |                 |          |
| 18 x 24 mm   | Plastic  | black  | <b>41-947.0</b> | 0.002 kg |



Rear side

PCB plug-in base

| Dimension  | Pins  | Terminal | Part No.      | Weight   |
|--|-------|----------|---------------|----------|
|  <p><b>PCB plug-in base</b></p> |       |          |               |          |
| 23.8 x 17.7 x 9.8 mm   | axial | PCB      | <b>41-940</b> | 0.004 kg |

The component layouts you will find from page 14

Flat receptacle

| Product attribute  | Part No.      | Weight   |
|--|---------------|----------|
|  <p><b>Flat receptacle</b></p> |               |          |
| 2.0 x 0.5 mm plug-in terminal  | <b>31-945</b> | 0.001 kg |

Insulation sleeve

| Product attribute   | Part No.      | Weight   |
|---|---------------|----------|
|  <p><b>Insulation sleeve</b></p> |               |          |
| for flat receptacle 2.0 mm  | <b>31-928</b> | 0.001 kg |

# 41 Accessories

## Illumination

### LED, T1 3/4 MG

#### Additional Information

- Due to high surface temperatures, the series resistor must not be soldered directly to the terminals of the equipment (use a terminal plate)
- Order two LEDs
- When using AC/DC types with AC operation, slight flickering can occur
- Luminous intensity data of the LEDs on direct voltage
- Electrical and optical data are measured at 25 °C
- The specified versions are built with a protection diode (half wave rectifier) in series and the LED
- Luminosity and wave length variations caused by LED manufacturing processes may cause slight differences regarding the illumination



Dimensions [mm]

| LED colour  | Operating voltage | Operation current | Lumi. intensity | Dom. wavelength | Part No.            | Weight   |
|---|-------------------|-------------------|-----------------|-----------------|---------------------|----------|
|  <p><b>Single-LED</b></p> |                   |                   |                 |                 |                     |          |
| Single-LED red  | 6 VDC +10 %       | 15 mA ±15 %       | 350 mcd         | 630 nm          | <b>10-2J06.3142</b> | 0.002 kg |
|   | 12 VAC/DC +10 %   | 7/14 mA ±15 %     | 330 mcd         | 630 nm          | <b>10-2J09.1062</b> | 0.002 kg |
|   | 24 VAC/DC +10 %   | 7/14 mA ±15 %     | 330 mcd         | 630 nm          | <b>10-2J12.1062</b> | 0.002 kg |
|   | 28 VAC/DC +10 %   | 7/14 mA ±15 %     | 330 mcd         | 630 nm          | <b>10-2J13.1062</b> | 0.002 kg |
|   | 48 VAC/DC +10 %   | 4/8 mA ±15 %      | 200 mcd         | 630 nm          | <b>10-2J19.1042</b> | 0.002 kg |
| Single-LED yellow   | 6 VDC +10 %       | 15 mA ±15 %       | 300 mcd         | 587 nm          | <b>10-2J06.3144</b> | 0.002 kg |
|   | 12 VAC/DC +10 %   | 7/14 mA ±15 %     | 280 mcd         | 587 nm          | <b>10-2J09.1064</b> | 0.002 kg |
|   | 24 VAC/DC +10 %   | 7/14 mA ±15 %     | 280 mcd         | 587 nm          | <b>10-2J12.1064</b> | 0.002 kg |
|   | 28 VAC/DC +10 %   | 7/14 mA ±15 %     | 280 mcd         | 587 nm          | <b>10-2J13.1064</b> | 0.002 kg |
|   | 48 VAC/DC +10 %   | 4/8 mA ±15 %      | 180 mcd         | 587 nm          | <b>10-2J19.1044</b> | 0.002 kg |
| Single-LED green  | 6 VDC +10 %       | 7 mA ±15 %        | 1050 mcd        | 525 nm          | <b>10-2J06.3145</b> | 0.002 kg |
|   | 12 VAC/DC +10 %   | 4/7 mA ±15 %      | 1050 mcd        | 525 nm          | <b>10-2J09.1065</b> | 0.002 kg |
|   | 24 VAC/DC +10 %   | 4/7 mA ±15 %      | 1050 mcd        | 525 nm          | <b>10-2J12.1065</b> | 0.002 kg |
|   | 28 VAC/DC +10 %   | 4/7 mA ±15 %      | 1050 mcd        | 525 nm          | <b>10-2J13.1065</b> | 0.002 kg |
|   | 48 VAC/DC +10 %   | 2/4 mA ±15 %      | 600 mcd         | 525 nm          | <b>10-2J19.1045</b> | 0.002 kg |
| Single-LED blue   | 6 VDC +10 %       | 15 mA ±15 %       | 680 mcd         | 470 nm          | <b>10-2J06.3146</b> | 0.002 kg |
|   | 12 VAC/DC +10 %   | 7/14 mA ±15 %     | 650 mcd         | 470 nm          | <b>10-2J09.1066</b> | 0.002 kg |
|   | 24 VAC/DC +10 %   | 7/14 mA ±15 %     | 650 mcd         | 470 nm          | <b>10-2J12.1066</b> | 0.002 kg |
|   | 28 VAC/DC +10 %   | 7/14 mA ±15 %     | 650 mcd         | 470 nm          | <b>10-2J13.1066</b> | 0.002 kg |
|   | 48 VAC/DC +10 %   | 4/8 mA ±15 %      | 400 mcd         | 470 nm          | <b>10-2J19.1046</b> | 0.002 kg |
| Single-LED white  | 6 VDC +10 %       | 15 mA ±15 %       | 750 mcd         | x0.31/y0.32 nm  | <b>10-2J06.3149</b> | 0.002 kg |
|   | 12 VAC/DC +10 %   | 7/14 mA ±15 %     | 700 mcd         | x0.31/y0.32 nm  | <b>10-2J09.1069</b> | 0.002 kg |
|   | 24 VAC/DC +10 %   | 7/14 mA ±15 %     | 700 mcd         | x0.31/y0.32 nm  | <b>10-2J12.1069</b> | 0.002 kg |
|   | 28 VAC/DC +10 %   | 7/14 mA ±15 %     | 700 mcd         | x0.31/y0.32 nm  | <b>10-2J13.1069</b> | 0.002 kg |
|   | 48 VAC/DC +10 %   | 4/8 mA ±15 %      | 400 mcd         | x0.31/y0.32 nm  | <b>10-2J19.1049</b> | 0.002 kg |

**Filament lamp, T1 3/4 MG**

- Order two filament lamps

| Operating voltage   | Operation current | Part No.            | Weight   |
|---|-------------------|---------------------|----------|
|  <p><b>Filament lamp</b></p> |                   |                     |          |
| 6 VAC/DC  | 120 mA±10 %       | <b>10-1306.1349</b> | 0.001 kg |
| 6.3 VAC/DC  | 200 mA±10 %       | <b>10-1307.1369</b> | 0.001 kg |
| 12 VAC/DC   | 75 mA±10 %        | <b>10-1309.1309</b> | 0.001 kg |
| 14 VAC/DC   | 80 mA±10 %        | <b>10-1310.1319</b> | 0.001 kg |
| 18 VAC/DC   | 40 mA±10 %        | <b>10-1311.1249</b> | 0.001 kg |
| 24 VAC/DC   | 35 mA±10 %        | <b>10-1312.1229</b> | 0.001 kg |
| 28 VAC/DC   | 30 mA±10 %        | <b>10-1313.1209</b> | 0.001 kg |
| 28 VAC/DC   | 40 mA±10 %        | <b>10-1313.1249</b> | 0.001 kg |
| 36 VAC/DC   | 20 mA±10 %        | <b>10-1316.1179</b> | 0.001 kg |
| 36 VAC/DC   | 30 mA±10 %        | <b>10-1316.1209</b> | 0.001 kg |
| 48 VAC/DC   | 20 mA±10 %        | <b>10-1319.1179</b> | 0.001 kg |
| 48 VAC/DC   | 25 mA±10 %        | <b>10-1319.1199</b> | 0.001 kg |

**Series resistor**

**Additional Information**

- Only for filament lamp 48 VAC, 25 mA
- For lamp voltage reduction
- Keep to the country specific safety instructions
- Due to high surface temperatures, the series resistor must not be soldered directly to the terminals of the equipment (use a terminal plate)

| Operating voltage   | Resistance | Part No.        | Weight   |
|---|------------|-----------------|----------|
|  <p><b>Series resistor</b></p> |            |                 |          |
| 110 VAC   | 2.7 kOhm   | <b>02-904.0</b> | 0.003 kg |
| 125 VAC   | 3.3 kOhm   | <b>02-904.1</b> | 0.003 kg |
| 145 VAC   | 4.7 kOhm   | <b>02-904.3</b> | 0.003 kg |
| 240 VAC   | 10 kOhm    | <b>02-904.7</b> | 0.003 kg |

# 41 Accessories

## Terminal plate empty

| Product attribute   | Dimension          | Part No.        | Weight   |
|---|--------------------|-----------------|----------|
| <br><b>Terminal plate empty</b> |                    |                 |          |
| 5 spaces  | 62.5 x 60 x 15 mm  | <b>02-912.1</b> | 0.025 kg |
| 10 spaces   | 125 x 60 x 15 mm   | <b>02-912.2</b> | 0.045 kg |
| 15 spaces   | 187.6 x 60 x 15 mm | <b>02-912.3</b> | 0.090 kg |
| 20 spaces   | 250 x 60 x 15 mm   | <b>02-912.4</b> | 0.095 kg |

Mounting

Lens remover

| Product attribute  | Part No.      | Weight   |
|--|---------------|----------|
|  <p><b>Lens remover</b></p> |               |          |
| for raised design  | <b>02-905</b> | 0.011 kg |

Lamp remover

Additional Information

▲ **Caution:** A switching process might be released when replacing the lamp

| Part No.   | Weight   |
|--|----------|
|  <p><b>Lamp remover</b></p> |          |
| <b>61-9740.0</b>   | 0.003 kg |

Dismantling tool

| Part No.   | Weight   |
|--|----------|
|  <p><b>Dismantling tool</b></p> |          |
| <b>41-939</b>  | 0.027 kg |

# 41 Drawings

## Drawings

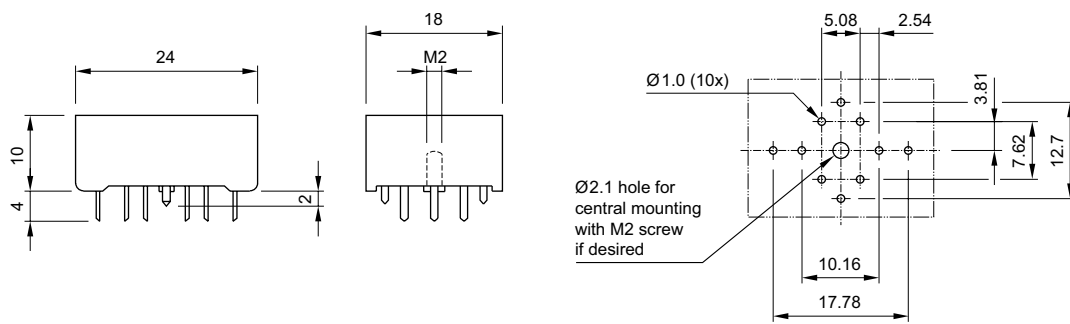

**Actuator with snap-action switching element**
**Switching system**

Self-cleaning, double-break, snap action switching system (with contact gap 2 x 0.5 mm).

1 normally closed or 1 normally open contact per element.  
Up to 4 switching elements can be on a pushbutton (max. 4 normally closed and 4 normally open contacts).

**Material**
**Material of contacts**

gold-plated silver

**Switching element**

Soldering terminal: PA 6.6 Ultramid

**Actuator case**

Polysulfone, heat-resistant and self-extinguishing

**Mechanical characteristics**
**Connection method**

Snap-action switching element with tinned soldering terminals at the sides:

max. wire diameter: 2 wires à 1.2 mm

max. wire cross-section of stranded cable: 1x 1 mm<sup>2</sup>

**Actuating force**

2-5.5 N, depending on the number of switching elements

**Actuating travel**

3 mm

**Mechanical life**

Momentary action 2 million cycles of operation

Maintained action 1 million cycles of operation

**Electrical characteristics**
**Standards**

IEC 61058 EN 61058

**Rated voltage**

250 VAC/VDC

**Rated current**

5 A

**Volume resistance**

Starting value  $\leq 50 \text{ m}\Omega$

**Conventional free air thermal current  $I_{th}$** 

5 A

The maximum current in continuous operation and at ambient temperature not exceeding the quoted maximum values.

**Switch rating**

250 VAC/5 A ( $\cos\varphi 1$ )

250 VAC/3 A ( $\cos\varphi 0.3$ )

Switch rating AC,  $\cos\varphi 0.7$ :

Voltage 125 V 250 V

Current 3 A 2 A

Switch rating DC (inductive), L:R = 30 ms

Voltage 24 V 60 V 110 V 220 V

Current 2 A 0.7 A 0.2 A 0.1 A

**Electric strength**

2500 VAC, 50 Hz, 1 min. between all terminals and earth, as per IEC 60512-2-11

**Protection class**

II

**Environmental conditions**
**Storage temperature**

-40 °C to +85 °C

**Service temperature**

-25 °C to +55 °C

for indicators and illuminated pushbuttons mounted as a block, make sure the heat can escape freely

**Degree of protection**

Front as per IEC 60529: IP 40

**Resistance to shock**

(single impacts, semi-sinusoidal)

15 g for 11 ms as per IEC 60512-4-3, IEC 60068-2-27

**Resistance to vibration**

(sinusoidal)

10 g at 0-2000 Hz, amplitude 1.5 mm as per IEC 60512-4-4, IEC 60068-2-6

**Resistance to climate**

Standard condition as per IEC 60068-2-3 and 2-30

Changing condition as per IEC 60068-2-14 and 2-33

**Approvals**
**Approbations**

CB (IEC 61058)

CSA

UL

Germanischer Lloyd

**Declaration of conformity**

CE

# 41 Technical data

## Actuator with Low Level switching element

### Switching system

This low level switching element was designed for switching low powers in electronic circuits. The mechanism assures reliable switching of loads ranging from a few mA/mV up to 100mA/42 VAC/VDC.

Single-break momentary contact, as normally open or normally closed with 4 independent points of contact. 2 momentary contacts per switching element; combination of normally open and normally closed is possible.

Special features are the long life, extremely short rebound time and stable contact resistance.

### Material

#### Actuator case

Polysulfone, heat-resistant and self-extinguishing

#### Material of contacts

gold-plated

#### Switching element

Polysulfone, heat-resistant and self-extinguishing

### Mechanical characteristics

#### Connection method

The universal terminals permit these units to be mounted on printed circuit boards (PCB). These terminals can also be used as soldering or plug-in terminals.

For these terminals we can also supply a plug-in base which, when soldered on to the board, enables the switch to be plugged in.

Soldering terminal

max. wire diameter: 2 wires of 0.8 mm

max. wire cross-section of stranded cable: 1 x 0.75 mm<sup>2</sup>

Plug-in terminal

2.0 x 0.5 mm

#### Actuating force

3-3.5 N

#### Actuating travel

3 mm

### Rebound time

Typ. < 100 μs

### Mechanical life

Momentary action 5 million cycles of operation

Maintained action 1 million cycles of operation

### Electrical characteristics

#### Volume resistance

starting value ≤ 50 mΩ

#### Switch rating

10 μA/100 μV to 100 μA at 42 VAC/VDC

#### Electric strength

2500 VAC, 50 Hz, 1 min. between all terminals and earth, as per IEC 60512-2-11.

#### Protection class

II

### Environmental conditions

#### Storage temperature

-40 °C to +85 °C

#### Service temperature

-25 °C to +55 °C

for indicators and illuminated pushbuttons mounted as a block, make sure the heat can escape freely

#### Degree of protection

Front as per IEC 60529: IP 40

#### Resistance to shock

(single impacts, semi-sinusoidal)

15 g for 11 ms as per IEC 60512-4-3, IEC 60068-2-27

#### Resistance to climate

Standard condition as per IEC 60068-2-3 and 2-30

Changing condition as per IEC 60068-2-14 and 2-33



## General notes

### 1. Engraving

#### Typefaces

In addition to the most commonly used world languages (see DIN 1451) with close spacing, the following typefaces are available: Scandinavian, Slavian, Greek, Russian.

#### Coloured filling of engraving

Specify whether engraving should be on the diffuser, or on the lens. Specify the infill colour, character height and the text or symbol orientation.

#### Symbols

A list of the symbols available can be supplied on request.

### 2. Hot stamping

For large batches it is worth while to have the lettering produced by hot stamping.

#### Typefaces

For letters and figures, typefaces with 2.5 mm, 3 mm and 4 mm are available.

#### Symbols

A list of the symbols available can be supplied on request.

### 3. Film inserts

Instead of using engraving, the lenses can be fitted with transparent film inserts. For this purpose, though, it is advisable to use transparent lenses.

To insert the film, the feet of the lens support have to be pushed together far enough to enable the lens to be lifted off easily.

#### Film dimensions

max. 12.7 x 18.7 mm (monocolour lens)

max. 9 x 12.7 mm (two-colour lens)

#### Film thickness 0.2 mm

Important: Before engraving, check the position of the illuminated pushbuttons or indicator.

All dimensions in mm

| Height of letters h | Thickness of letters s | Number of lines | Number of capital letters per line (target value) | Number of small letters per line (target value) | Image |
|---------------------|------------------------|-----------------|---|---|-------|
| 2.5                 | 0.4                    | 4               | 11  | 12  | B1    |
| 3                   | 0.4                    | 3               | 9-10  | 10-11   | B1    |
| 4                   | 0.5                    | 2               | 7   | 7-8   | B1    |
| 5                   | 0.5                    | 2               | 5-6   | 6   | B1    |
| 6                   | 0.6                    | 1               | 4-5   | 5   | B1    |
| 8                   | 0.6                    | 1               | 3-4   | 3-4   | B1    |
| 2.5                 | 0.4                    | 5               | 7-8   | 8   | B2    |
| 3                   | 0.4                    | 4               | 6-7   | 7   | B2    |
| 4                   | 0.5                    | 3               | 4-5   | 5   | B2    |
| 5                   | 0.5                    | 2               | 3-4   | 4   | B2    |
| 6                   | 0.6                    | 2               | 3   | 3-4   | B2    |
| 8                   | 0.6                    | 1               | 2-3   | 2-3   | B2    |
| 2.5                 | 0.4                    | 4               | 5-6   | 5-6   | B3    |
| 3                   | 0.4                    | 3               | 4-5   | 5   | B3    |
| 4                   | 0.5                    | 2               | 3   | 3-4   | B3    |
| 5                   | 0.5                    | 2               | 2-3   | 3   | B3    |
| 6                   | 0.6                    | 1               | 2   | 2-3   | B3    |
| 8                   | 0.6                    | 1               | 1-2   | 1-2   | B3    |
| 2.5                 | 0.4                    | 2               | 7-8   | 8   | B4    |
| 3                   | 0.4                    | 2               | 6-7   | 7   | B4    |
| 4                   | 0.5                    | 1               | 4-5   | 5   | B4    |
| 5                   | 0.5                    | 1               | 3-4   | 4   | B4    |
| 6                   | 0.6                    | 1               | 3   | 3-4   | B4    |
| 8                   | 0.6                    | 1               | 2-3   | 2-3   | B4    |

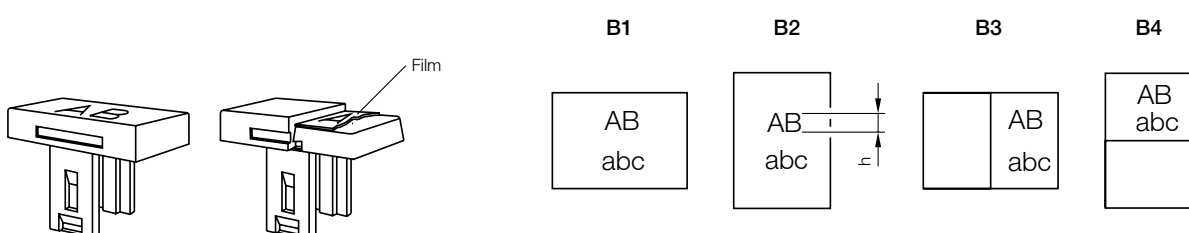

# 41 Application guidelines

## Suppressor circuits

When switching inductive loads such as relays, DC motors, and DC solenoids, it is always important to absorb surges (e.g. with a diode) to protect the contacts. When these inductive loads are switched off, a counter emf can severely damage switch contacts and greatly shorten lifetime.

Fig. 1 shows an inductive load with a free-wheeling diode connected in parallel. This free-wheeling diode provides a path for the inductor current to flow when the current is interrupted by the switch. Without this free-wheeling diode, the voltage across the coil will be limited only by dielectric breakdown voltages of the circuit or parasitic elements of the coil. This voltage can be kilovolts in amplitude even when nominal circuit voltages are low (e.g. 12VDC) see Fig. 2.

The free-wheeling diode should be chosen so that the reverse breakdown voltage is greater than the voltage driving the inductive load. The DC blocking voltage ( $V_R$ ) of the free-wheeling diode can be found in the datasheet of a diode. The forward current should be equal or greater than the maximum current flowing through the load.

**To get an efficient protection, the free-wheeling diode must be connected as close as possible to the inductive load!**

Switching with inductive load  
Fig. 1

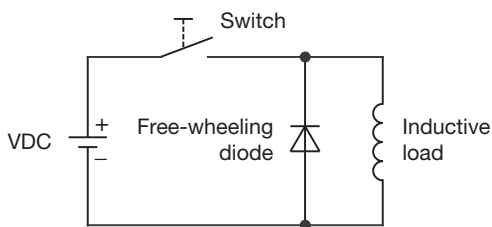

Counter EMF  
over load without free-wheeling diode  
Fig. 2

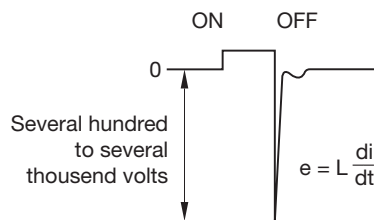

## Index from Part No.

| Part No.     | Page | Part No.   | Page |
|--------------|------|------------|------|
| 02-904.0     | 11   | 41-907.2/5 | 7    |
| 02-904.1     | 11   | 41-907.2/6 | 7    |
| 02-904.3     | 11   | 41-907.2/7 | 7    |
| 02-904.7     | 11   | 41-907.3/5 | 7    |
| 02-905       | 13   | 41-907.3/6 | 7    |
| 02-912.1     | 12   | 41-907.3/7 | 7    |
| 02-912.2     | 12   | 41-907.4/5 | 7    |
| 02-912.3     | 12   | 41-907.4/6 | 7    |
| 02-912.4     | 12   | 41-907.4/7 | 7    |
| 10-1306.1349 | 11   | 41-907.5/6 | 7    |
| 10-1307.1369 | 11   | 41-907.5/7 | 7    |
| 10-1309.1309 | 11   | 41-907.6/7 | 7    |
| 10-1310.1319 | 11   | 41-907.7/7 | 7    |
| 10-1311.1249 | 11   | 41-908.2/3 | 7    |
| 10-1312.1229 | 11   | 41-908.2/4 | 7    |
| 10-1313.1209 | 11   | 41-908.2/5 | 7    |
| 10-1313.1249 | 11   | 41-908.2/7 | 7    |
| 10-1316.1179 | 11   | 41-908.3/4 | 7    |
| 10-1316.1209 | 11   | 41-908.3/5 | 7    |
| 10-1319.1179 | 11   | 41-908.3/7 | 8    |
| 10-1319.1199 | 11   | 41-908.4/5 | 8    |
| 10-2J06.3142 | 10   | 41-908.4/7 | 8    |
| 10-2J06.3144 | 10   | 41-908.5/7 | 8    |
| 10-2J06.3145 | 10   | 41-908.7/7 | 8    |
| 10-2J06.3146 | 10   | 41-925     | 8    |
| 10-2J06.3149 | 10   | 41-939     | 13   |
| 10-2J09.1062 | 10   | 41-940     | 9    |
| 10-2J09.1064 | 10   | 41-947.0   | 8    |
| 10-2J09.1065 | 10   | 61-9740.0  | 13   |
| 10-2J09.1066 | 10   |            |      |
| 10-2J09.1069 | 10   |            |      |
| 10-2J12.1062 | 10   |            |      |
| 10-2J12.1064 | 10   |            |      |
| 10-2J12.1065 | 10   |            |      |
| 10-2J12.1066 | 10   |            |      |
| 10-2J12.1069 | 10   |            |      |
| 10-2J13.1062 | 10   |            |      |
| 10-2J13.1064 | 10   |            |      |
| 10-2J13.1065 | 10   |            |      |
| 10-2J13.1066 | 10   |            |      |
| 10-2J13.1069 | 10   |            |      |
| 10-2J19.1042 | 10   |            |      |
| 10-2J19.1044 | 10   |            |      |
| 10-2J19.1045 | 10   |            |      |
| 10-2J19.1046 | 10   |            |      |
| 10-2J19.1049 | 10   |            |      |
| 31-928       | 9    |            |      |
| 31-945       | 9    |            |      |
| 41-040.005   | 4    |            |      |
| 41-041.006   | 4    |            |      |
| 41-121.0252  | 5    |            |      |
| 41-122.0252  | 5    |            |      |
| 41-123.0252  | 5    |            |      |
| 41-124.0252  | 5    |            |      |
| 41-261.0252  | 5    |            |      |
| 41-262.0252  | 5    |            |      |
| 41-263.0252  | 5    |            |      |
| 41-264.0252  | 5    |            |      |
| 41-421.036   | 5    |            |      |
| 41-422.036   | 5    |            |      |
| 41-423.036   | 5    |            |      |
| 41-461.036   | 5    |            |      |
| 41-462.036   | 5    |            |      |
| 41-463.036   | 5    |            |      |
| 41-903.2     | 7    |            |      |
| 41-903.3     | 7    |            |      |
| 41-903.4     | 7    |            |      |
| 41-903.5     | 7    |            |      |
| 41-903.6     | 7    |            |      |
| 41-903.7     | 7    |            |      |
| 41-904.2     | 7    |            |      |
| 41-904.3     | 7    |            |      |
| 41-904.4     | 7    |            |      |
| 41-904.5     | 7    |            |      |
| 41-904.7     | 7    |            |      |
| 41-907.2/3   | 7    |            |      |
| 41-907.2/4   | 7    |            |      |





Компания «ЭлектроПласт» предлагает заключение долгосрочных отношений при поставках импортных электронных компонентов на взаимовыгодных условиях!

Наши преимущества:

- Оперативные поставки широкого спектра электронных компонентов отечественного и импортного производства напрямую от производителей и с крупнейших мировых складов;
- Поставка более 17-ти миллионов наименований электронных компонентов;
- Поставка сложных, дефицитных, либо снятых с производства позиций;
- Оперативные сроки поставки под заказ (от 5 рабочих дней);
- Экспресс доставка в любую точку России;
- Техническая поддержка проекта, помощь в подборе аналогов, поставка прототипов;
- Система менеджмента качества сертифицирована по Международному стандарту ISO 9001;
- Лицензия ФСБ на осуществление работ с использованием сведений, составляющих государственную тайну;
- Поставка специализированных компонентов (Xilinx, Altera, Analog Devices, Intersil, Interpoint, Microsemi, Aeroflex, Peregrine, Syfer, Eurofarad, Texas Instrument, Miteq, Cobham, E2V, MA-COM, Hittite, Mini-Circuits, General Dynamics и др.);

Помимо этого, одним из направлений компании «ЭлектроПласт» является направление «Источники питания». Мы предлагаем Вам помощь Конструкторского отдела:

- Подбор оптимального решения, техническое обоснование при выборе компонента;
- Подбор аналогов;
- Консультации по применению компонента;
- Поставка образцов и прототипов;
- Техническая поддержка проекта;
- Защита от снятия компонента с производства.



#### Как с нами связаться

**Телефон:** 8 (812) 309 58 32 (многоканальный)

**Факс:** 8 (812) 320-02-42

**Электронная почта:** [org@eplast1.ru](mailto:org@eplast1.ru)

**Адрес:** 198099, г. Санкт-Петербург, ул. Калинина, дом 2, корпус 4, литера А.