

# MINI-AT™

Small AVR development board fitted in DIP26 form factor, containing ATmega328 microcontroller.

# TO OUR VALUED CUSTOMERS

I want to express my thanks to you for being interested in our products and for having confidence in Mikroelektronika.

The primary aim of our company is to design and produce high quality electronic products and to constantly improve the performance thereof in order to better suit your needs.

A handwritten signature in white ink, appearing to read 'N. Matic', is positioned on the right side of the page. The signature is fluid and cursive, with a large initial 'N' and 'M'.

Nebojsa Matic  
General Manager

# Table of Contents

---

Introduction to MINI-AT	4
Key features	4
System Specification	5
1. Programming with Bootloader	6
2. Schematics	8
3. Pinout	10
4. Dimensions	11

---

# Introduction to MINI-AT

Miniature and powerful development tool designed to work as a stand alone device or as MCU card in DIP26 socket. MINI-AT is pre programmed with bootloader so it is not necessary to have external programmer. If there is a need for external programmer (AVR ISP) attach it to MINI-AT via pads marked with PB3 (SO), RB4 (SI), RB5 (SC) and PC6 (RST).

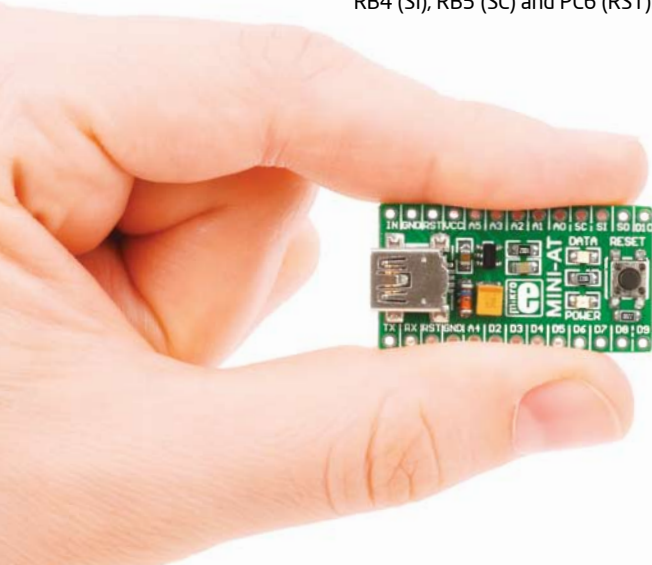

## Key features

- 01 Connection Pads
- 02 USB MINI-B connector
- 03 Power supply regulator
- 04 POWER supply LED
- 05 DATA LED
- 06 Reset button
- 07 FTDI IC
- 08 Microcontroller ATmega328
- 09 Crystal oscillator

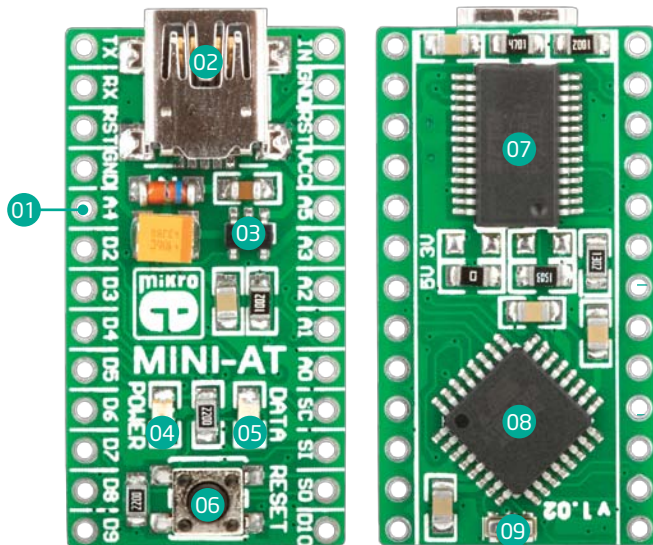

## System Specification



### power supply

3.3V or 5V via USB (depending on which MINI-AT board you are using)



### power consumption

depends on MCU state (max current is 300mA)



### board dimensions

33.02 x 17.78mm (1.3 x 0.7")



### weight

~4g (0.009 lbs)

# 1. Programming with Bootloader

When you are ready to start writing your first projects for MINI-AT, you need to download and install the desired AVR compiler. Choose between mikroC, mikroBasic and mikroPascal compilers, which can be found on following address:



<http://www.mikroe.com/eng/categories/view/21/avr-compilers/>



After the installation run the compiler and write the desired code. You can also use provided LedBlinking example as your first project. When you are done writing the code click on **Project->Build (F11)** option to create output .HEX file. Now you need to upload the generated .HEX into the MCU. But before that connect MINI-AT to a PC via MINI-B USB cable (**Figure 1-1**).

Now you will need to download and install the bootloader application and integrate it with your compiler. Download link is available on the MINI-AT webpage. We also provided a nice video tutorial which will guide you through the bootloading process.



<http://www.mikroe.com/eng/products/view/649/mini-at-board/>

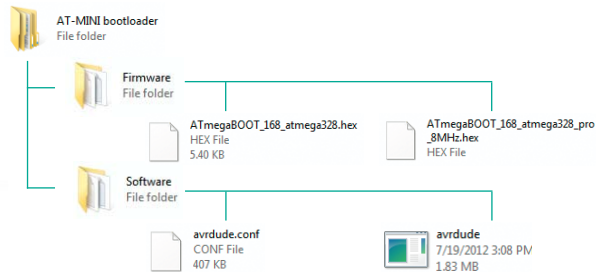

**NOTE:** If you accidentally overwrite the bootloader program it is possible to load it again. In the Firmware folder you can find bootloader .hex files which can be loaded into the microcontroller via the AVR ISP programmer.

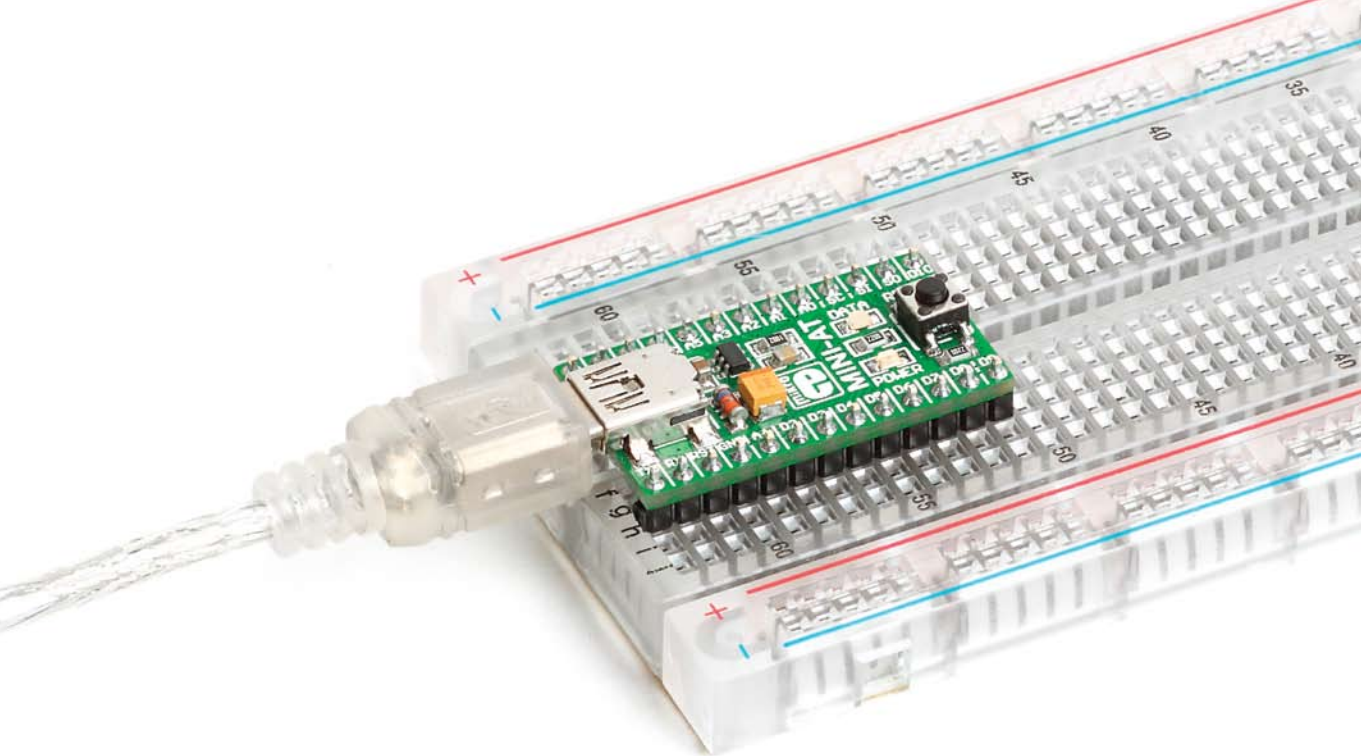
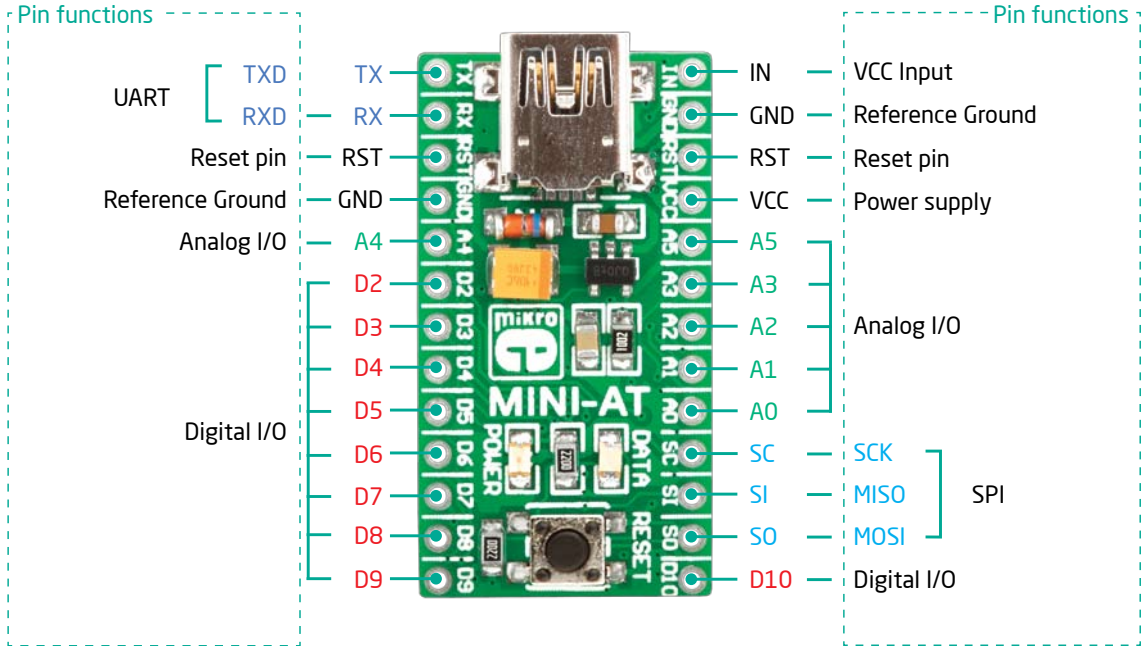

**Figure 1-1: Connected MINI-AT via USB cable**





# 3. Pinout



■ Digital lines  
 ■ Analog Lines  
 ■ SPI Lines  
 ■ UART lines

## 4. Dimensions

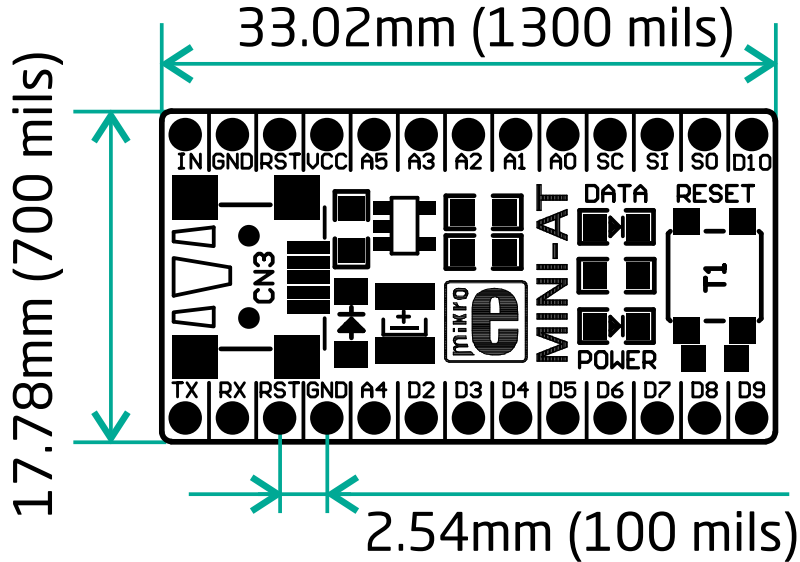

Notes:

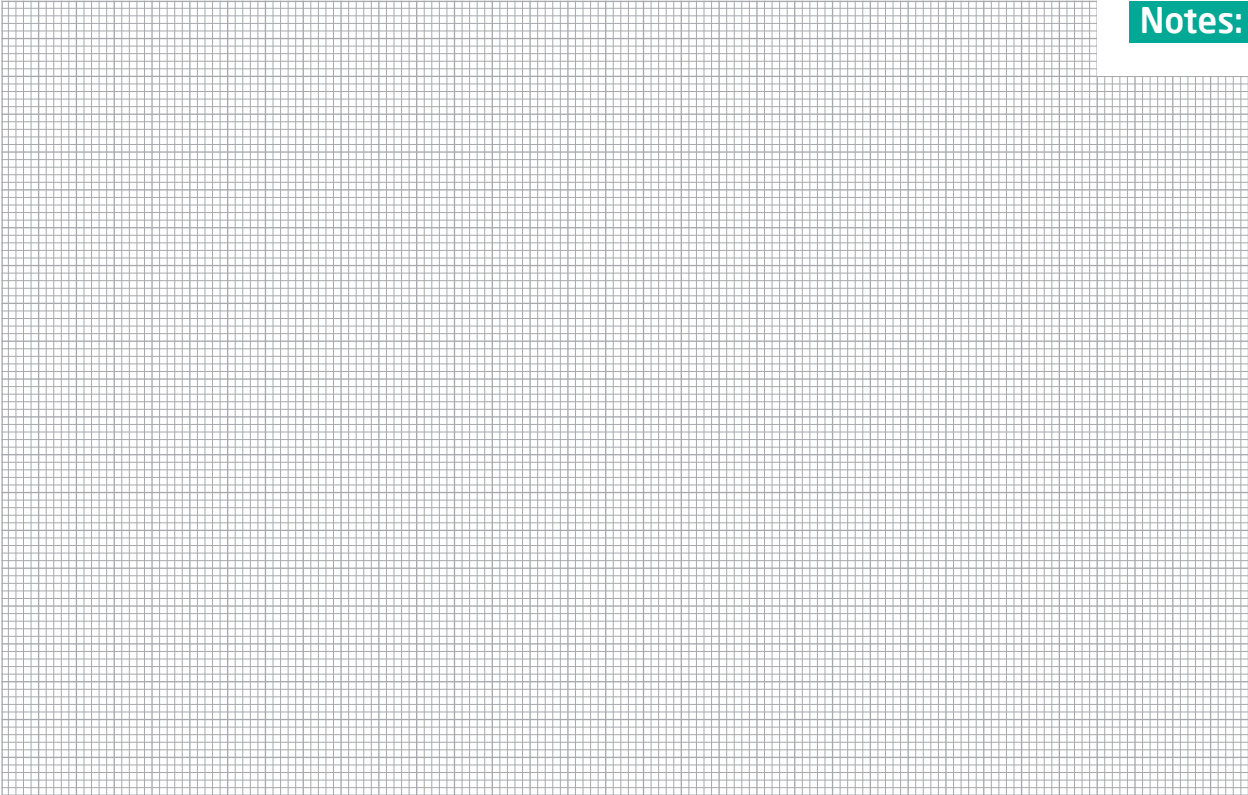

Notes:

## DISCLAIMER

All the products owned by MikroElektronika are protected by copyright law and international copyright treaty. Therefore, this manual is to be treated as any other copyright material. No part of this manual, including product and software described herein, may be reproduced, stored in a retrieval system, translated or transmitted in any form or by any means, without the prior written permission of MikroElektronika. The manual PDF edition can be printed for private or local use, but not for distribution. Any modification of this manual is prohibited.

MikroElektronika provides this manual 'as is' without warranty of any kind, either expressed or implied, including, but not limited to, the implied warranties or conditions of merchantability or fitness for a particular purpose.

MikroElektronika shall assume no responsibility or liability for any errors, omissions and inaccuracies that may appear in this manual. In no event shall MikroElektronika, its directors, officers, employees or distributors be liable for any indirect, specific, incidental or consequential damages (including damages for loss of business profits and business information, business interruption or any other pecuniary loss) arising out of the use of this manual or product, even if MikroElektronika has been advised of the possibility of such damages. MikroElektronika reserves the right to change information contained in this manual at any time without prior notice, if necessary.

## HIGH RISK ACTIVITIES

The products of MikroElektronika are not fault - tolerant nor designed, manufactured or intended for use or resale as on - line control equipment in hazardous environments requiring fail - safe performance, such as in the operation of nuclear facilities, aircraft navigation or communication systems, air traffic control, direct life support machines or weapons systems in which the failure of Software could lead directly to death, personal injury or severe physical or environmental damage ('High Risk Activities'). MikroElektronika and its suppliers specifically disclaim any expressed or implied warranty of fitness for High Risk Activities.

## TRADEMARKS

The MikroElektronika name and logo, the MikroElektronika logo, mikroC™, mikroBasic™, mikroPascal™, EasyAVR™, mikroBUS™, Click Boards™, MINI-AT™, mikroProg™, and mikromedia™ are trademarks of MikroElektronika. All other trademarks mentioned herein are property of their respective companies.

All other product and corporate names appearing in this manual may or may not be registered trademarks or copyrights of their respective companies, and are only used for identification or explanation and to the owners' benefit, with no intent to infringe.



If you want to learn more about our products, please visit our website at [www.mikroe.com](http://www.mikroe.com)

If you are experiencing some problems with any of our products or just need additional information, please place your ticket at [www.mikroe.com/esupport](http://www.mikroe.com/esupport)

If you have any questions, comments or business proposals,  
do not hesitate to contact us at [office@mikroe.com](mailto:office@mikroe.com)

MINI - AT Manual  
ver. 1.02



0 100000 021187



Компания «ЭлектроПласт» предлагает заключение долгосрочных отношений при поставках импортных электронных компонентов на взаимовыгодных условиях!

Наши преимущества:

- Оперативные поставки широкого спектра электронных компонентов отечественного и импортного производства напрямую от производителей и с крупнейших мировых складов;
- Поставка более 17-ти миллионов наименований электронных компонентов;
- Поставка сложных, дефицитных, либо снятых с производства позиций;
- Оперативные сроки поставки под заказ (от 5 рабочих дней);
- Экспресс доставка в любую точку России;
- Техническая поддержка проекта, помощь в подборе аналогов, поставка прототипов;
- Система менеджмента качества сертифицирована по Международному стандарту ISO 9001;
- Лицензия ФСБ на осуществление работ с использованием сведений, составляющих государственную тайну;
- Поставка специализированных компонентов (Xilinx, Altera, Analog Devices, Intersil, Interpoint, Microsemi, Aeroflex, Peregrine, Syfer, Eurofarad, Texas Instrument, Miteq, Cobham, E2V, MA-COM, Hittite, Mini-Circuits, General Dynamics и др.);

Помимо этого, одним из направлений компании «ЭлектроПласт» является направление «Источники питания». Мы предлагаем Вам помощь Конструкторского отдела:

- Подбор оптимального решения, техническое обоснование при выборе компонента;
- Подбор аналогов;
- Консультации по применению компонента;
- Поставка образцов и прототипов;
- Техническая поддержка проекта;
- Защита от снятия компонента с производства.

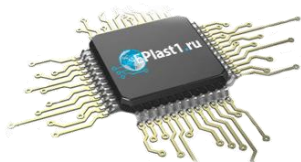

#### Как с нами связаться

**Телефон:** 8 (812) 309 58 32 (многоканальный)

**Факс:** 8 (812) 320-02-42

**Электронная почта:** [org@eplast1.ru](mailto:org@eplast1.ru)

**Адрес:** 198099, г. Санкт-Петербург, ул. Калинина, дом 2, корпус 4, литера А.