

»» Features

- Mini ISO high power automotive relay 30A/50A.
- High temperature endurance up to 125 degree C.
- Optional SPNC, SPNO, SPDT, DPNO contact configurations.
- Optional to be equipped with protection diode or resistor.
- Both available PCB terminal and quick connect terminal versions.
- Available for plain cover type, skirted cover flanged cover, and weather proof versions.
- Tinned terminal is available on request.
- Comply with RoHS-Directive 2002/95/EC, and ELV-Directive 2000/53/EC.

»» Type List

Terminal style	Contact form	Enclosure style		
		Dust cover	Flux tight	Sealed type washable
Socket terminal	1A (SPNO)	896-1AH-D	896-1AH-C	896-1AH-S
		896H-1AH-D	896H-1AH-C	896H-1AH-S
	1C (SPDT)	896-1CH-D	896-1CH-C	896-1CH-S
		896H-1CH-D	896H-1CH-C	896H-1CH-S
	2A (DPNO)	896-2AH-D	896-2AH-C	896-2AH-S
		896H-2AH-D	896H-2AH-C	896H-2AH-S
PCB terminal	1A (SPNO)	896P-1AH-D	896P-1AH-C	896P-1AH-S
		896HP-1AH-D	896HP-1AH-C	896HP-1AH-S
	1C (SPDT)	896P-1CH-D	896P-1CH-C	896P-1CH-S
		896HP-1CH-D	896HP-1CH-C	896HP-1CH-S
	2A (DPNO)	896P-2AH-D	896P-2AH-C	896P-2AH-S
		896HP-2AH-D	896HP-2AH-C	896HP-2AH-S

Terminal style	Contact form	Enclosure style	
		Flanged cover (dust cover)	Flanged cover (flux tight)
Socket terminal	1A (SPNO)	896-1AH-D1	896-1AH-C1
		896H-1AH-D1	896H-1AH-C1
	1C (SPDT)	896-1CH-D1	896-1CH-C1
		896H-1CH-D1	896H-1CH-C1
	2A (DPNO)	896-2AH-D1	896-2AH-C1
		896H-2AH-D1	896H-2AH-C1

Terminal style	Contact form	Enclosure style	
		Steel bracket (dust cover)	Steel bracket (flux tight)
Socket terminal	1A (SPNO)	896-1AH-D1S	896-1AH-C1S
		896H-1AH-D1S	896H-1AH-C1S
	1C (SPDT)	896-1CH-D1S	896-1CH-C1S
		896H-1CH-D1S	896H-1CH-C1S
	2A (DPNO)	896-2AH-D1S	896-2AH-C1S
		896H-2AH-D1S	896H-2AH-C1S

Terminal style	Contact form	Designation (provided with)	Enclosure style	
			Steel bracket (dust cover with shroud)	Steel bracket (dust cover with weather proof)
Socket terminal	1C (SPDT)	Resistor	896H-1CH-D1SF-R1	896H-1CH-D1SW-R1

»» Ordering Information

896 H P - 1CH - C - R1 - T 001
 1 2 3 4 5 6 7 8

- | | | | | | |
|----|-------|--|------|---|------------------|
| 1. | 896 | -- Basic series designation | D1S | -- Steel bracket (dust cover) | |
| 2. | Blank | -- Standard type | C1S | -- Steel bracket (flux tight) | |
| | H | -- High power type | S1S | -- Steel bracket (sealed type washable) | |
| 3. | Blank | -- Socket terminal | D1SF | -- Steel bracket (dust cover with shroud) | |
| | P | -- PCB terminal | D1SW | -- Steel bracket (dust cover with weather proof) | |
| 4. | 1AH | -- Single pole normally open, contact material AgSnO | 6. | Blank | -- Standard type |
| | 1BH | -- Single pole normally closed, contact material AgSnO | R1 | -- Coil parallel with resistor 1/2W for 12V 680Ω , 24V 2700Ω | |
| | 1CH | -- Single pole double throw, contact material AgSnO | 7. | Blank | -- Standard type |
| | 2AH | -- Double pole double make, contact material AgSnO | T | -- Special requirement for Tin plated terminal | |
| 5. | D | -- Dust cover | 8. | Blank | -- Standard type |
| | C | -- Flux tight | 001 | -- Coil parallel with diode IN4007 the positive pole on # 85 terminal | |
| | S | -- Sealed type washable | 002 | -- Coil parallel with diode IN4007 the negative pole on # 85 terminal | |
| | C1 | -- Flanged cover (flux tight) | | | |
| | D1 | -- Flanged cover (dust cover) | | | |
| | S1 | -- Flanged cover (sealed type washable) | | | |

»» Contact Rating

Type	896 1A	896 1B	896 1C	896 2A
Resistive load	40A 14VDC	40A 14VDC	NO : 40A 14VDC NC : 30A 14VDC	2×15A 14VDC

Type	896H 1A	896H 1B	896H 1C	896H 2A
Resistive load	50A 14VDC 20A 28VDC	40A 14VDC 15A 28VDC	NO : 50A 14VDC, 20A 28VDC NC : 30A 14VDC, 15A 28VDC	2×30A 14VDC 2×10A 28VDC

»» Coil Rating(DC)

Rated voltage (V)	Rated current ±10 % at 23°C (mA)	Coil resistance ±10 % at 23°C (Ω)	Max. continuous Voltage at 85°C ⁽¹⁾	Pick up voltage(Max) at 23°C	Drop out voltage(Min) at 23°C	Power consumption at rated voltage
12	133	90	120 % of rated voltage	65 % of rated voltage	10 % of rated voltage	approx. 1.6W
24	66.7	360				

Notes : (1) Without switching the load.

»» Specification

Contact material	AgSnO alloy	
Contact voltage drop ⁽¹⁾	Typ. 50mV at 10A	
Insulation resistance ⁽¹⁾	20MΩ Min. (DC 500V)	
Operate time ⁽¹⁾	20ms Max.	
Release time ⁽¹⁾	20ms Max.	
Dielectric strength ⁽¹⁾	Between open contact	: AC 500V , 50/60Hz 1 min.
	Between contact and coil	: AC 500V , 50/60Hz 1 min.
Vibration resistance	Operating extremes	10~55Hz , amplitude 2mm
Shock resistance	Operating extremes	10G
	Damage limits	100G
Life expectancy	Mechanical	10,000,000 operations (frequency 18,000 operations/hr)
	Electrical	100,000 operations (frequency 1,200 operations/hr)
Temperature range	Operating	-40 ~ +125°C (no freezing)
Weight	Approx. 40 g	

Note : (1) initial value

>>> Outline Dimensions

◆ 896,896H (C,D,S)

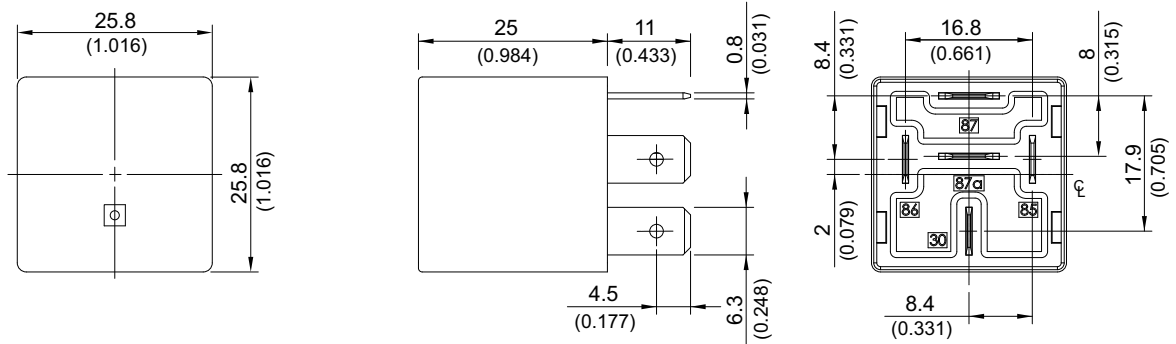

◆ 896,896H (C1,D1,S1)

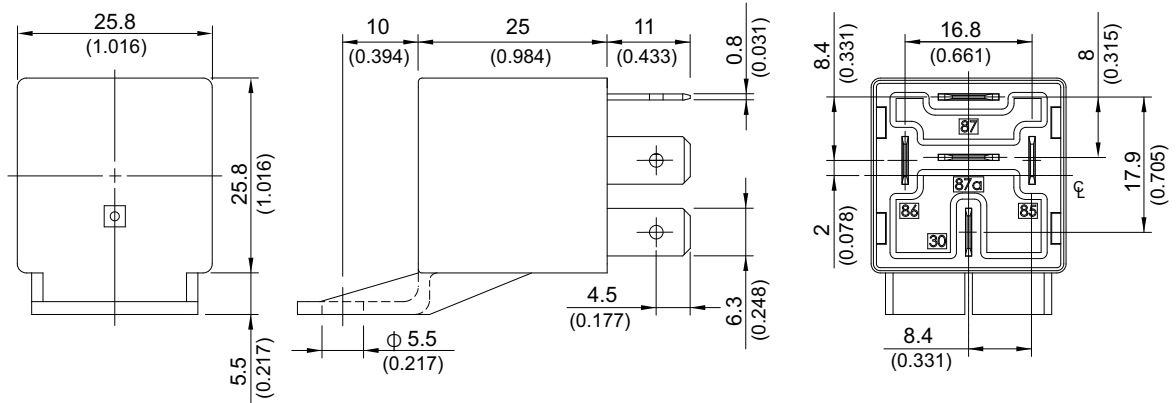

◆ 896,896H (C1S,D1S,S1S)

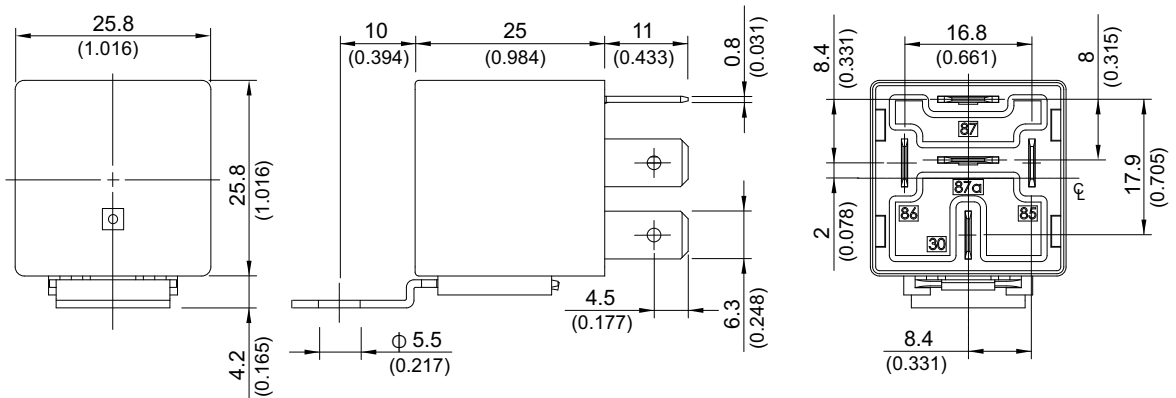

◆ 896P,896HP (C,D,S)

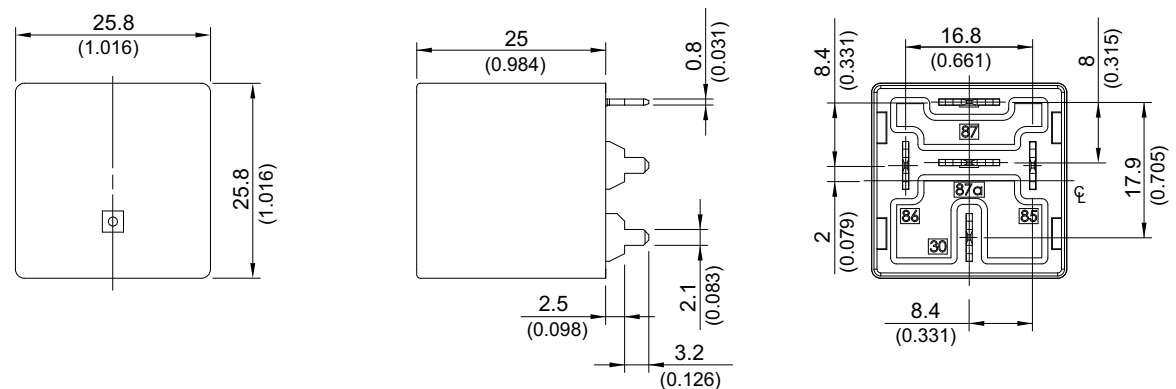

◆ 896H (D1SW)

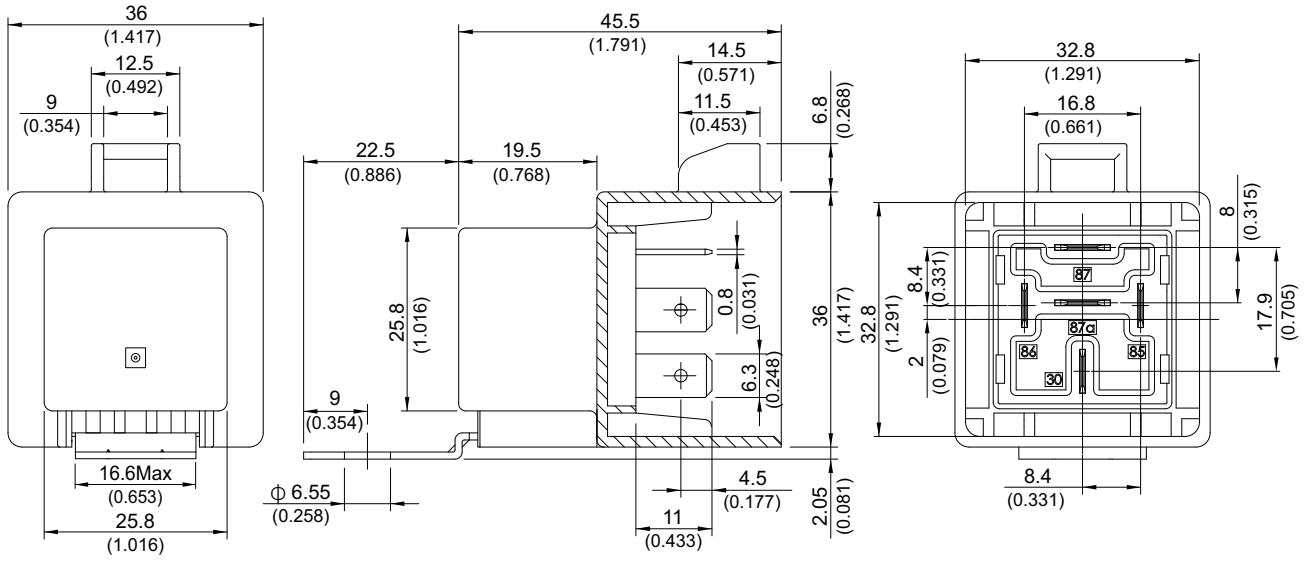

◆ 896H (D1SF)

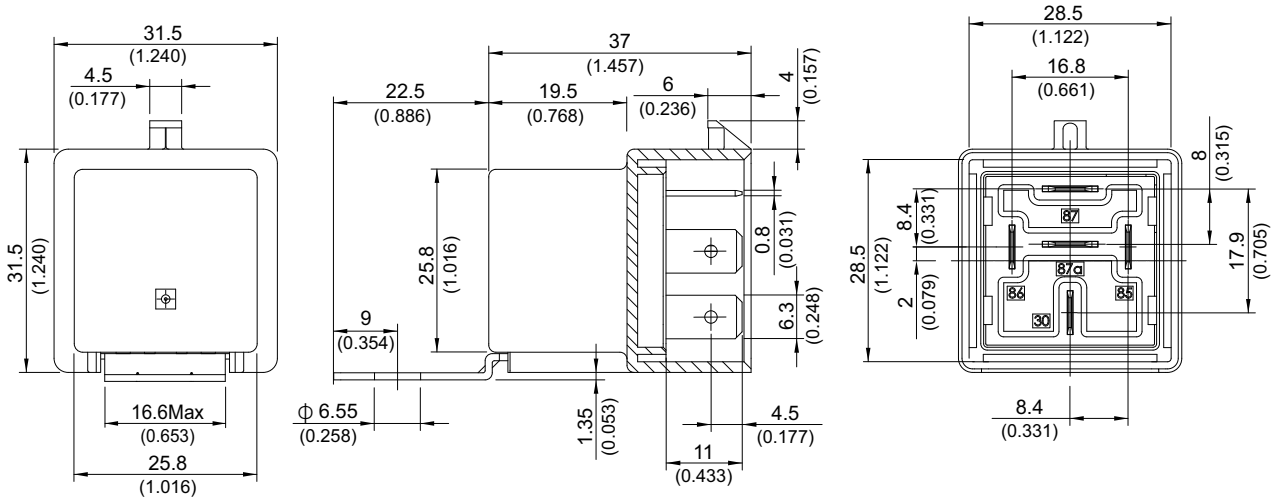

»» Wiring Diagram

BOTTOM VIEW

1A

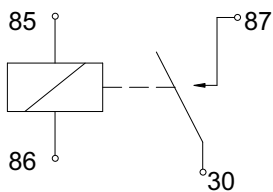

1B

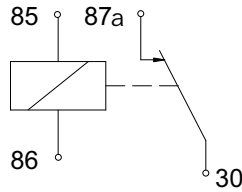

1C

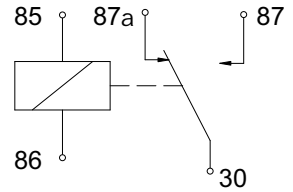

2A

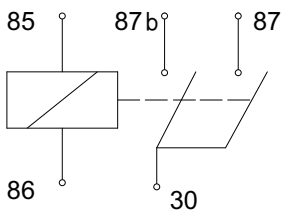

R1

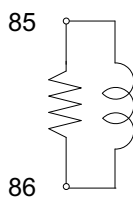

001

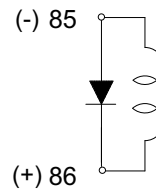

002

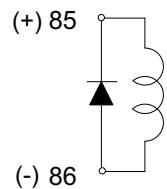

»» PC Board Layout

BOTTOM VIEW

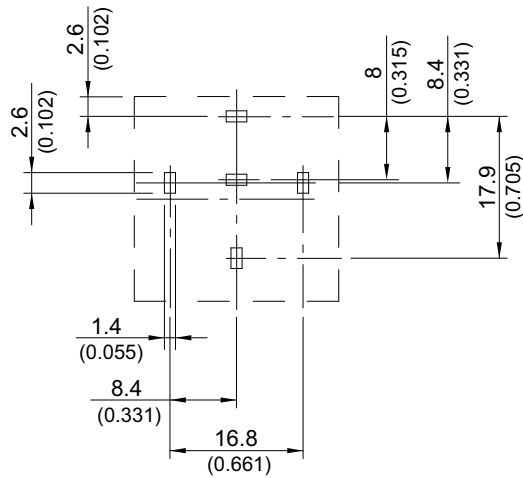

»» Engineering Data

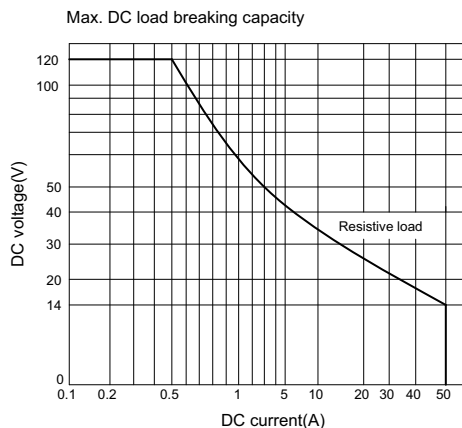
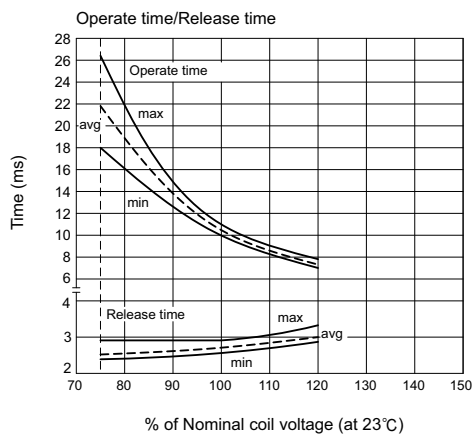
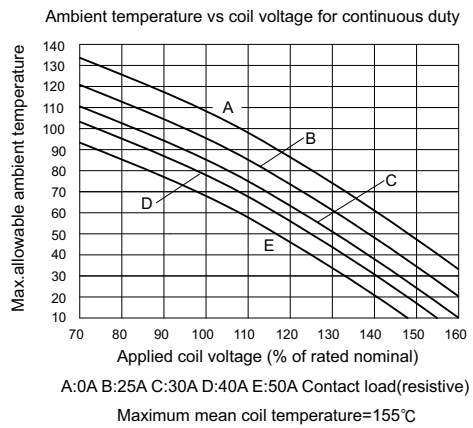
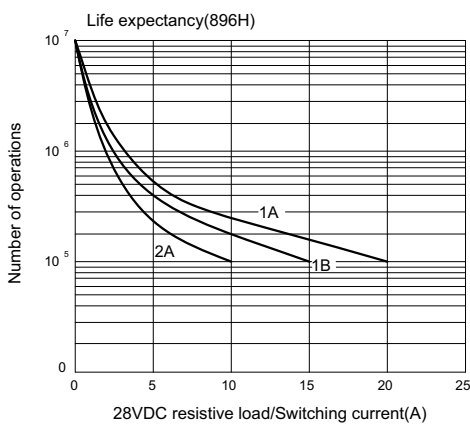
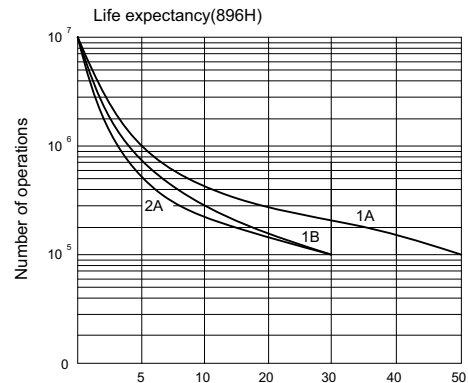
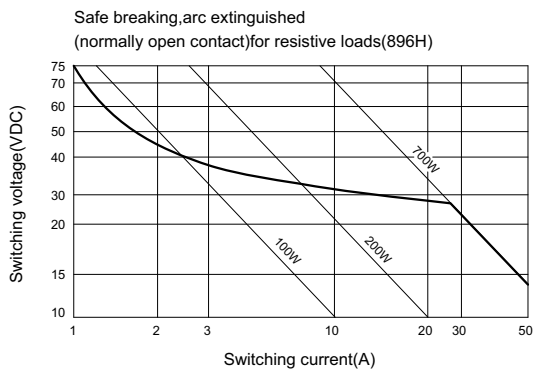



Компания «ЭлектроПласт» предлагает заключение долгосрочных отношений при поставках импортных электронных компонентов на взаимовыгодных условиях!

Наши преимущества:

- Оперативные поставки широкого спектра электронных компонентов отечественного и импортного производства напрямую от производителей и с крупнейших мировых складов;
- Поставка более 17-ти миллионов наименований электронных компонентов;
- Поставка сложных, дефицитных, либо снятых с производства позиций;
- Оперативные сроки поставки под заказ (от 5 рабочих дней);
- Экспресс доставка в любую точку России;
- Техническая поддержка проекта, помощь в подборе аналогов, поставка прототипов;
- Система менеджмента качества сертифицирована по Международному стандарту ISO 9001;
- Лицензия ФСБ на осуществление работ с использованием сведений, составляющих государственную тайну;
- Поставка специализированных компонентов (Xilinx, Altera, Analog Devices, Intersil, Interpoint, Microsemi, Aeroflex, Peregrine, Syfer, Eurofarad, Texas Instrument, Miteq, Cobham, E2V, MA-COM, Hittite, Mini-Circuits, General Dynamics и др.);

Помимо этого, одним из направлений компании «ЭлектроПласт» является направление «Источники питания». Мы предлагаем Вам помощь Конструкторского отдела:

- Подбор оптимального решения, техническое обоснование при выборе компонента;
- Подбор аналогов;
- Консультации по применению компонента;
- Поставка образцов и прототипов;
- Техническая поддержка проекта;
- Защита от снятия компонента с производства.



Как с нами связаться

Телефон: 8 (812) 309 58 32 (многоканальный)

Факс: 8 (812) 320-02-42

Электронная почта: org@eplast1.ru

Адрес: 198099, г. Санкт-Петербург, ул. Калинина, дом 2, корпус 4, литера А.