

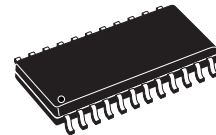

## CAR RADIO DIAGNOSTIC PROCESSOR

- WIDE OPERATING VOLTAGE RANGE
- ST-BY FUNCTION (C-MOS)
- LOW QUIESCENT ST-BY CURRENT CONSUMPTION
- I<sup>2</sup>C BUS INTERFACE WITH 2 EXTERNALLY SELECTABLE ADDRESSES
- UP TO 5 BTL EQUIVALENT INPUTS FOR FAULT DETECTION IN THE AUDIO CHANNELS
  - short to GND
  - short to V<sub>s</sub>
  - short across the load (at turn-on)
  - open load (at turn-on)
- 2 AUX INPUTS FOR FAULT DETECTION IN THE ANTENNA AND BOOSTERS SUPPLY LINE- short to GND- open load
- WARNING PIN FUNCTION (interrupt facility) ACTIVATED IN THE FOLLOWING CONDITION:
  - audio channel shorted to V<sub>s</sub>
  - audio channel shorted to GND
  - aux input shorted to GND
- NOISE FREE DIAGNOSTICS OPERATION
- PROTECTORS
- LOAD DUMP VOLTAGE
- OPEN GND
- REVERSED BATTERY
- ESD

### MULTIPOWER BCD TECHNOLOGY



SO-24

ORDERING NUMBER: TDA7476

### DESCRIPTION

The car radio diagnostic processor is an interface chip in BCD Technology intended for car radio applications. It is able to detect potential faults coming from any misconnection in the car radio or in the harness when installing the set.

The device is able to reveal any fault in the loudspeaker lines and in the antenna and booster supply lines, providing a proper output signal (I<sup>2</sup>C bus compatible) in order to disable the ICs under fault and/or to alert the micro-controller by means of warning messages.

### PIN CONNECTION (Top view)

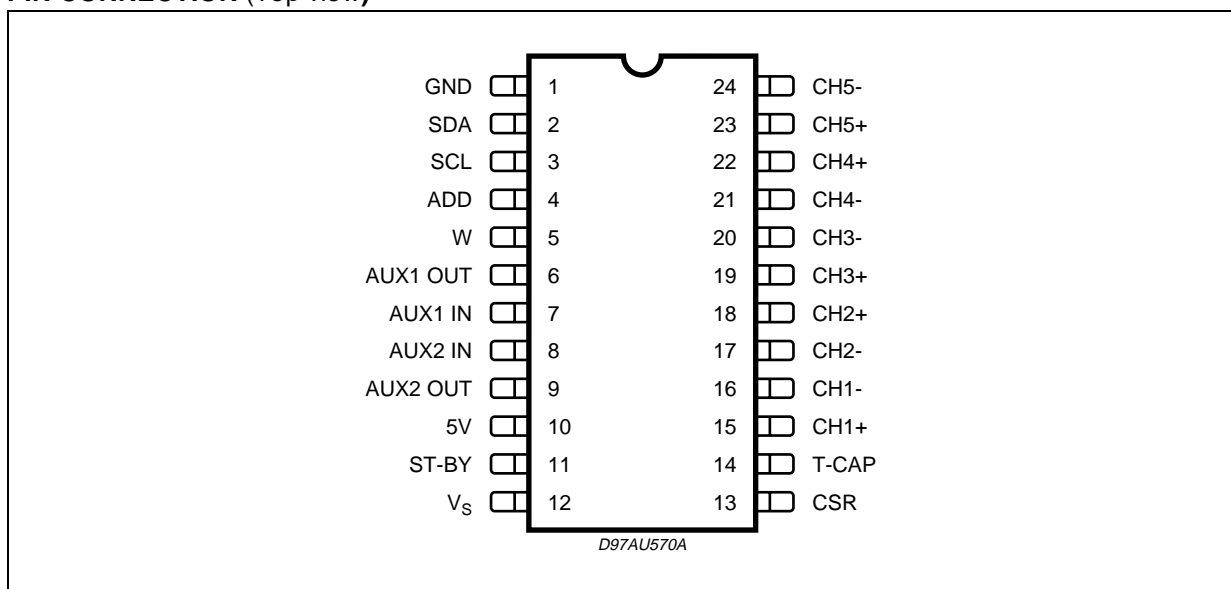

**BLOCK DIAGRAM & APPLICATION CIRCUIT**

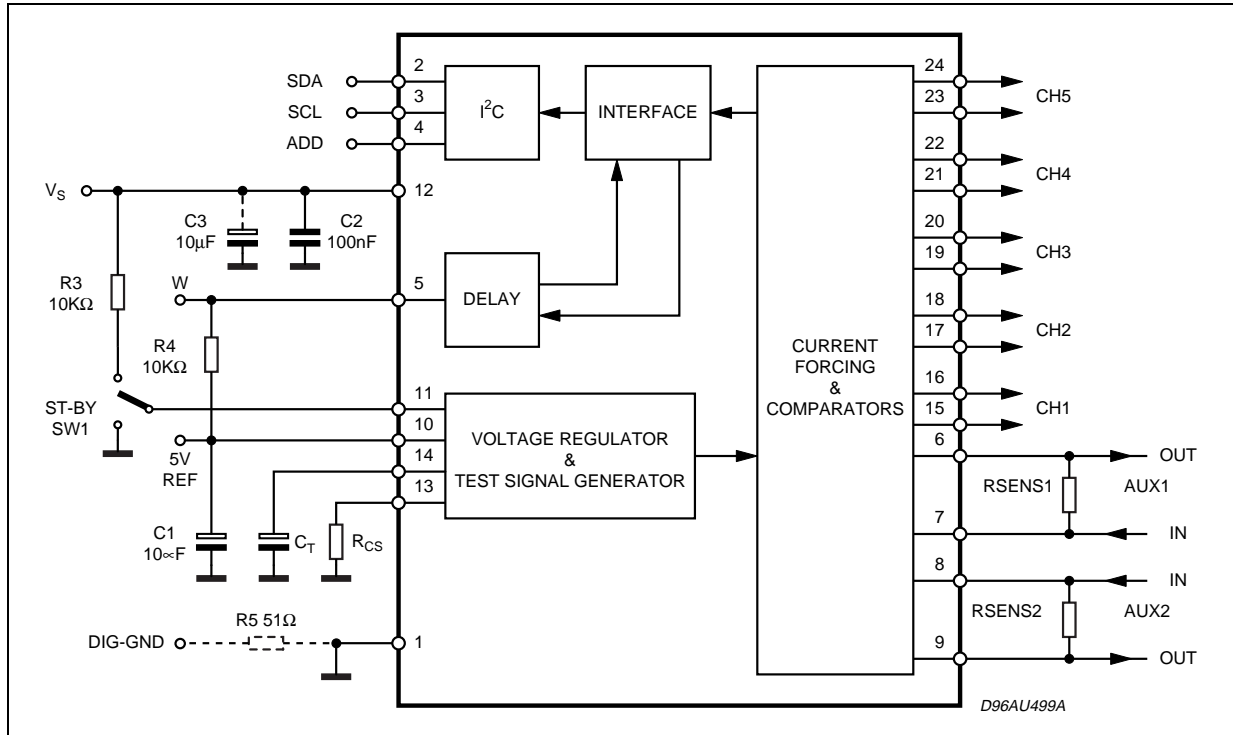

**PIN FUNCTION**

| N°    | Pin       | Description              |
|-------|-----------|--------------------------|
| 1     | GND       | Ground                   |
| 2     | SDA       | Data line                |
| 3     | SCL       | Clock line               |
| 4     | ADD       | Address select           |
| 5     | W         | Warning                  |
| 6     | AUX1 OUT  | AUX1 output              |
| 7     | AUX1 IN   | AUX1 input               |
| 8     | AUX2 IN   | AUX2 input               |
| 9     | AUX2 OUT  | AUX2 output              |
| 10    | 5V        | 5V-Regulator             |
| 11    | ST-BY     | Stand-by                 |
| 12    | Vs        | Supply Voltage           |
| 13    | CSR       | Current setting resistor |
| 14    | T-CAP     | Timing capacitor         |
| 15/16 | CH1+/CH1- | Audio output - Channel 1 |
| 17/18 | CH2-/CH2+ | Audio output - Channel 2 |
| 19/20 | CH3+/CH3- | Audio output - Channel 3 |
| 21/22 | CH4-/CH4+ | Audio output - Channel 4 |
| 23/24 | CH5+/CH5- | Audio output - Channel 5 |

**ABSOLUTE MAXIMUM RATINGS**

| Symbol                            | Parameter  | Value                            | Unit |
|-----------------------------------|--|----------------------------------|------|
| V <sub>op</sub>                   | Operating Supply Voltage                         | 18                               | V    |
| V <sub>s</sub>                    | DC Supply Voltage                                | 28                               | V    |
| V <sub>peak</sub>                 | Peak Supply Voltage t = 50ms                     | 40                               | V    |
| P <sub>tot</sub>                  | Total Power Dissipation T <sub>case</sub> = 25°C | 1.5                              | W    |
| T <sub>stg</sub> ; T <sub>c</sub> | Storage and Junction Temperature                 | -40 to 150                       | °C   |
| V <sub>SB</sub>                   | Stand-by Pin Voltage                             | 6                                | V    |
| V <sub>SDA</sub>                  | SDA Pin Voltage                                  | 6                                | V    |
| V <sub>SCL</sub>                  | SCL Pin Voltage                                  | 6                                | V    |
| V <sub>ADD</sub>                  | ADD Pin Voltage                                  | 6                                | V    |
| V <sub>CH</sub>                   | CH+ or CH- Pin Voltage                           | min (*) (V <sub>s</sub> +10, 25) |      |

(\*) Minimum value between V<sub>s</sub>+10V and 25V.

**THERMAL DATA**

| Symbol                | Parameter                              | Value   | Unit |
|-----------------------|--|---------|------|
| R <sub>Th j-amb</sub> | Thermal resistance junction to ambient | Max. 85 | °C/W |

**ELECTRICAL CHARACTERISTICS**

(V<sub>s</sub> = 14.4V; T<sub>amb</sub> = 25°, unless otherwise specified.)

| Symbol             | Parameter                    | Test Condition                                     | Min. | Typ. | Max. | Unit |
|--------------------|------------------------------|--|------|------|------|------|
| V <sub>SBIN</sub>  | Stand-By IN Threshold        |  |      |      | 1.5  | V    |
| V <sub>SBOUT</sub> | Stand-By OUT Threshold       |  | 3.5  |      |      | V    |
| I <sub>SB</sub>    | Stand-By Current Consumption | Stand-By Voltage Pin = 1.5V                        |      |      | 100  | μA   |
| I <sub>q</sub>     | Total Quiescent Current      | Total quiescent Current with TDA7476 not addressed |      | 5    |      | mA   |

**AUDIO INPUTS CH1, CH2, CH3, CH4, CH5 - TURN ON DIAGNOSTIC**

|                  |   |                                    |                     |  |                     |   |
|------------------|---|------------------------------------|---------------------|--|---------------------|---|
| P <sub>gnd</sub> | Short to GND det. (below this limit, the Audio Output is considered in Short Circuit to GND)                        | Power amplifier in st-by condition |                     |  | 0.8                 | V |
| P <sub>vs</sub>  | Short to V <sub>s</sub> det. (above this limit, the Audio Output is considered in Short Circuit to V <sub>s</sub> ) |                                    | V <sub>s</sub> -0.6 |  |                     | V |
| P <sub>nop</sub> | Normal operation thresholds. (Within these limits, the Audio Output is considered without faults)                   |                                    | 1.2                 |  | V <sub>s</sub> -1.2 | V |

**ELECTRICAL CHARACTERISTICS** (continued)  
 ( $V_s = 14.4V$ ;  $T_{amb} = 25^\circ$ , unless otherwise specified.)

| Symbol  | Parameter  | Test Condition                     | Min.   | Typ. | Max.   | Unit |
|---|--|------------------------------------|--------|------|--------|------|
| Lsc   | Shorted Load det. (voltage across the Audio Outputs). Below this limit the load is considered shorted.   | Power amplifier in st-by condition |        |      | 5      | mV   |
| Lop   | Open Load det. (voltage across the Audio Outputs). Above this limit the load is considered open.   |                                    | 550    |      |        | mV   |
| Lnop  | Normal load det. (Voltage across the Audio Output). Within these limits the load resistance is considered normal.                                    |                                    | 22     |      | 220    | mV   |
| <b>AUX INPUTS AUX1, AUX2 - TURN ON DIAGNOSTIC</b> |  |                                    |        |      |        |      |
| Agnd  | Short to GND det. (voltage across the sensing resistor). Above this limit the AUX pin is considered in Short Circuit to GND.                         | High side driver ON                | 0.85   |      |        | V    |
| Aol   | Open load det. (voltage across the sensing resistor). Below this limit the Aux pin is considered in Open Load condition.                             |                                    |        |      | 0.085  | V    |
| Anop  | Normal Operation det. (Voltage across the sensing resistor). Within these limits the load resistance connected to the Aux pin is considered correct. |                                    | 0.125  |      | 0.5    | V    |
| <b>AUDIO INPUTS - PERMANENT DIAGNOSTIC</b>        |  |                                    |        |      |        |      |
| Pgnd  | Short to GND det. (below this limit, the Audio Output is considered in Short Circuit to Vs) This condition must be true for a time higher than Tdel  | Power amplifier ON                 |        |      | 0.8    | V    |
| Pvs   | Short to Vs det. (above this limit the Audio Output is considered in Short Circuit to Vs) This condition must be true for a time higher than Tdel    |                                    | Vs-0.6 |      |        | V    |
| Pnop  | Normal operation thresholds. (Within these limits, the Audio Output is considered without faults)  |                                    | 1.2    |      | Vs-1.2 | V    |
| <b>AUX INPUTS - PERMANENT DIAGNOSTIC</b>          |  |                                    |        |      |        |      |
| Agnd  | Short to GND det. (above this limit, the Audio Output is considered in Short Circuit to Vs) This condition must be true for a time higher than Tdel  | High side driver ON                | 0.85   |      |        | V    |

**ELECTRICAL CHARACTERISTICS** (continued)(V<sub>S</sub> = 14.4V; T<sub>amb</sub> = 25°, unless otherwise specified.)

| Symbol   | Parameter   | Test Condition              | Min.  | Typ. | Max.  | Unit |
|--|---|-----------------------------|-------|------|-------|------|
| Aol  | Open load det. (voltage across the sensing resistor. Below this limit the Aux pin is considered in Open Load condition) This condition must be true for a time higher than Tdel | High side driver ON         |       |      | 0.085 | V    |
| Anop   | Normal Operation det. (Voltage across the sensing resistor. Within these limits the load resistance connected to the Aux pin is considered correct)                             |                             | 0.125 |      | 0.5   | V    |
| <b>PERMANENT DIAGNOSTIC - ACQUISITION TIME DELAY</b> |   |                             |       |      |       |      |
| Tdel   | Acquisition time delay - The fault is considered true if the fault condition are present for more than Tdel without interruption  |                             |       | 2    |       | s    |
| <b>PERMANENT DIAGNOSTIC - WARNING PIN</b>            |   |                             |       |      |       |      |
| V <sub>sat</sub>                                     | Saturation voltage on pin 5   | Sink Current at Pin 5 = 1mA |       |      | 1     | V    |
| <b>ADDRESS SELECT</b>                                |   |                             |       |      |       |      |
| V <sub>ADD</sub>                                     | Voltage on pin 4  | Address 0100010X            |       |      | 1.5   | V    |
|  |   | Address 0100011X            | 3     |      | 5     | V    |
| <b>I<sup>2</sup>C BUS INTERFACE</b>                  |   |                             |       |      |       |      |
| f <sub>SCL</sub>                                     | Clock Frequency   |                             |       |      | 400   | KHz  |
| V <sub>IL</sub>                                      | Input Low Voltage   |                             |       |      | 1.5   | V    |
| V <sub>IH</sub>                                      | Input High Voltage  |                             | 3     |      |       | V    |
| V <sub>SAT</sub>                                     | Sat Voltage at pin 2  | Sink Current at Pin 2 = 5mA |       |      | 1.5   | V    |

**WORKING PRINCIPLES****Turn-on diagnostic - CH1, CH2, CH3, CH4, CH5 - Shorted load/open load detection**

- To detect a short across the load or an open load, a subsonic current pulse is generated. The information related to the status of the outputs is measured and memorized at the top of the current pulse (t<sub>m</sub> in fig.1). The current is sourced by the positive pins (CH1+,...CH5+) and it is sunk by the corresponding negative pins (CH1-,...CH5-).

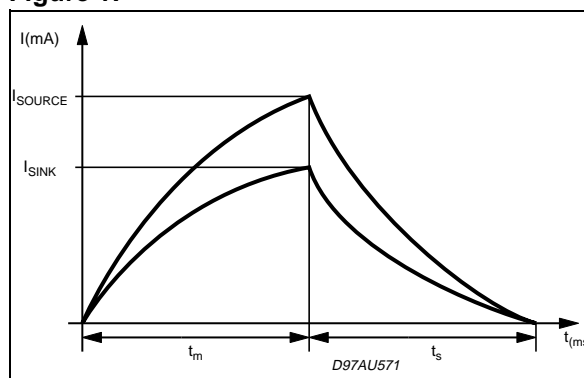
**Figure 1.**

- **Isink** and **Isorce** are depending on the external resistor **Rcs**. The minimum allowed value for Rcs is 1.65KOhm. The relationship among Isink, Isource and Rcs is the following:

$$I_{sink} = (3.3/R_{cs}) \cdot 11$$

$$I_{source} = 1.5 \cdot I_{sink}$$

- On **bridge** (or bridge equivalent) devices if there is no short circuit to GND or to Vs, Isource goes into saturation mode (for Vout > 3V), and in the load flows Isink. As the turn-on diagnostic thresholds are fixed, it is possible to calculate the ranges of loudspeaker resistance in which short circuit (S.C.), normal operation and open load are detected as following:

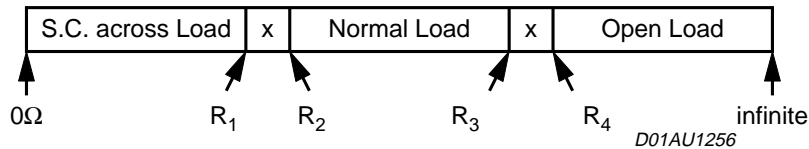

$$R1 = \frac{L_{sc,max}}{I_{sink}} = \frac{L_{sc,max}}{36.3} \cdot R_{cs}$$

$$R2 = \frac{L_{nop,min}}{I_{sink}} = \frac{L_{nop,min}}{36.3} \cdot R_{cs}$$

$$R3 = \frac{L_{nop,max}}{I_{sink}} = \frac{L_{nop,max}}{36.3} \cdot R_{cs}$$

$$R4 = \frac{L_{op,max}}{I_{sink}} = \frac{L_{op,max}}{36.3} \cdot R_{cs}$$

where  $L_{sc}$ ,  $L_{nop}$ ,  $L_{op}$  as specified in the ELECTRICAL CHARACTERISTICS.

For example, here below are two cases, with  $R_{cs} = 3.3KOhm$  and  $R_{cs} = 1.8KOhm$ .

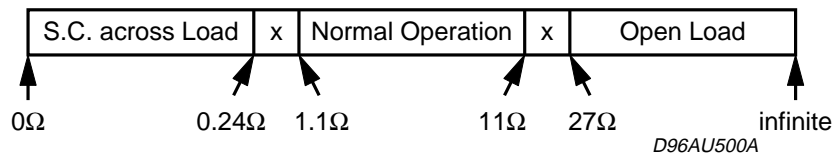
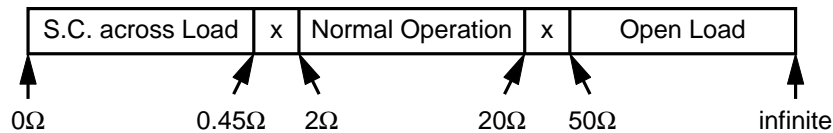

The exact values of the above mentioned resistive ranges may vary a little, depending on the power amplifier used.

**Turn-on diagnostic - CH1, CH2, CH3, CH4, CH5 - Short to GND and Vs.**

To detect if there is short circuit to GND or Vs, the subsonic current pulse is exploited. The information related to the status of the outputs are measured and memorized at the top of the current pulse ( $t_m$  in fig.1). If no faults are present, the pins connected to the audio outputs (CH1,..CH5) will reach about 3V. If one or more outputs are shorted to GND, these voltages become lower than 3V. If one or more outputs are shorted to Vs, the output voltage increases over 3V. The fault status can be know by sensing the output voltages. The reason way voltage threshold has been preferred instead of a current threshold to declare short circuit resistor ranges is two fold:

- 1) The amplifier can drain current in the resistive path of the short circuit, hence this current and consequently the short circuit resistor cannot be determined with a sufficient level of accuracy.
- 2) The voltage difference between the car radio ground (reference) and the position of the chassis of the car where the loudspeaker line is connected (due to an accidental short circuit) can be up to some hundreds of mV. This does not permit a correct measure of the short circuit resistor.

### Turn-on diagnostic - AUX1, AUX2

To detect if there is a short circuit to GND or an open load involving to the AUX output of the car radio, the voltage across a sensing resistor  $R_{sens}$  is detected. These output voltages (for example for the active antenna and for the booster) are usually generated by high side drivers, but also voltage regulators with  $V_{out} > 5V$  are admissible. The detection ranges can be set by adjusting the sensing resistors  $R_{sens1}$  or  $R_{sens2}$  as following:

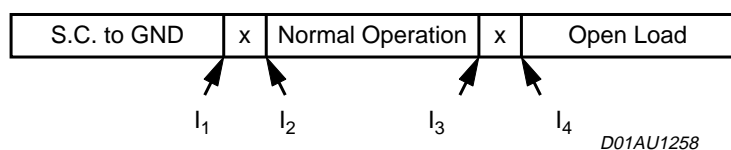

$$I_4 = \frac{A_{OL,max}}{R_{sens}}$$

$$I_3 = \frac{A_{nop,min}}{R_{sens}}$$

$$I_2 = \frac{A_{nop,max}}{R_{sens}}$$

$$I_1 = \frac{A_{gnd,min}}{R_{sens}}$$

Where  $A_{OL}$ ,  $A_{nop}$ ,  $A_{gnd}$  are as specified in the ELECTRICAL CHARACTERISTICS.

For example, if  $R_{sens} = 5 \text{ Ohm}$ , the following detection table will be operative :

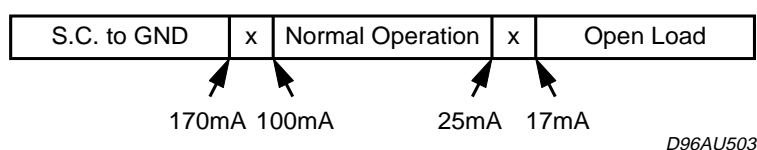

### Permanent diagnostic - CH1, CH2, CH3, CH4, CH5 - Short to GND and Vs

During the CAR-RADIO normal operation, to detect a short circuit to GND (or to  $V_s$ ), the output voltages are sensed. If one or more outputs stay at any voltage below  $0.8V$  or over  $V_s - 0.6V$  for more than 2 sec. (typ), the warning pin is pulled down. The  $\mu P$  can address the TDA7476 to know the status. The subsonic current pulse is activated also in this case. The fault is correctly detected if it remains until the memorization ( $t_m$  in fig.1). In this phase, faults regarding shorts across the load and open loads cannot be detected.

**Permanent diagnostic - AUX1, AUX2 - Short circuit to GND and open load**

- The detection mode of the auxiliary inputs is equal to what is in place during turn-on, but the fault must be lasting without interruption for more than 2 seconds. The warning pin is pulled down only in case of short to GND. This is to avoid that this pin remains permanently to 0 level if one or both AUX outputs of the car radio are unused.

**Timing**

- From the byte "ADD1" to the byte "ADD2" the mP must wait a period Twait1 (see Software Specification) that is depending on the timing capacitor CT according to the following table (Twait1 > tm, max):

| CT (μF) | tm max (ms) |
|---------|-------------|
| 3.3     | 45          |
| 4.7     | 65          |
| 10      | 130         |
| 22      | 290         |
| 47      | 620         |
| 100     | 1300        |

Note: any (positive) spread of the capacitor value must be added. The relation to be used to determine Twait1 from the value of CT according to the following:

$$Twait1 > tm, max = (130 \cdot CT / 10\mu F)ms$$

- After the byte "ADD2" the power amplifier can be switched-on. In some cases, the μP has to wait until the current pulse is finished (Twait2). This time (ts in fig.1) is given by:

$$Twait2 > ts, max = (140 \cdot CT / 10\mu F)ms$$

For bridge or bridge equivalent devices (figg.5,6), Ct = 10μF will be enough.

**TURN-ON DIAGNOSTIC - THRESHOLDS**

**CH1, CH2, CH3, CH4, CH5**

- Output voltage during test. (The power amplifier must be in ST-BY mode).

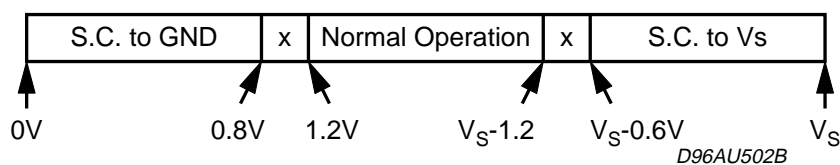

- Voltage across the load during test. (The power amplifier must be in ST-BY mode).

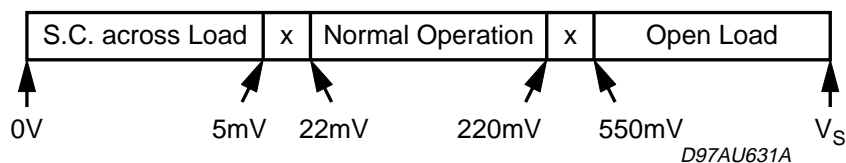

- Note: some faults can mask others if they are present at the same moment on the same channel:
  - If there is a short to GND and an open load on the same channel, the TDA7476 gives information only about one of them, depending on the wire on which the short circuit is present.
  - The short circuit to GND masks any short circuit across the load.
  - The short circuit to Vs masks any short or open load.



The following table shows the result pointed out by TDA7476 when multiple misconnections are present:

| ACTUAL FAULTS                          | POINTED OUT FAULT           |
|--|-----------------------------|
| S.C. CH+ to GND + OPEN LOAD            | S.C. to GND                 |
| S.C. CH(*) to GND + S.C. ACROSS LOAD   | S.C. to GND                 |
| S.C. CH- to GND + OPEN LOAD            | OPEN LOAD                   |
| S.C. CH(*) to $V_S$ + OPEN LOAD        | S.C. to $V_S$               |
| S.C. CH(*) to $V_S$ + S.C. ACROSS LOAD | S.C. to $V_S$               |
| S.C. CH+ to $V_S$ + S.C. CH- to GND    | S.C. to $V_S$               |
| S.C. CH- to $V_S$ + S.C. CH+ to GND    | S.C. to GND + S.C. to $V_S$ |

(\*) CH means CH+ or CH-

### AUX1 - AUX2

#### ■ Voltage across the sensing resistors

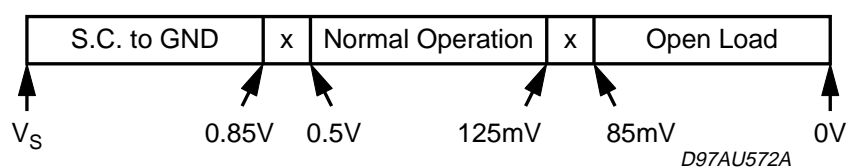

- The minimum voltage of the AUX IN pin to sense the open load condition is 2V.
- The minimum voltage of the AUX IN pin to detect the short circuit to GND, by sensing the drop on the resistors is 4.5V. If this voltage falls below 2V, the AUX in is considered short circuited to GND. From 2V to 4.5V the sensing circuit can detect a short circuit in both ways (by sensing across the resistor or through the voltage between the AUX IN pin and GND).

### PERMANENT DIAGNOSTIC - THRESHOLDS

#### CH1, CH2, CH3, CH4, CH5

- The circuit will recognize as a fault condition any situation where the following short circuit voltages last more than 2 sec (typ).
- Output voltage

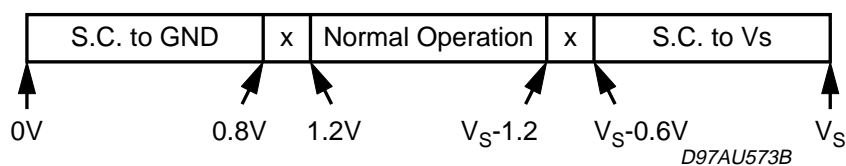

### AUX1 - AUX2

- The voltage across the resistors  $R_{sens1}$  or  $R_{sens2}$  is sensed. The circuit will recognize as a fault condition any situation where the following voltages last more than 2sec (typ) in the region "S.C.to GND" or "open load".

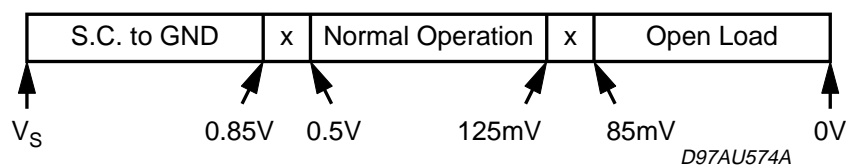

- The minimum voltage of the AUX IN pins to sense the open load condition is 2V.
- The minimum voltage of the AUX IN pin to detect the short circuit to GND by sensing drop on the resistor is 4.5V. If this voltage is below 2V, the AUX line is considered short circuited to GND. From 2V to 4.5V the sensing circuit can detect a short circuit in both ways (by sensing across the resistor or through the voltage between the AUX IN pin and GND).

## I<sup>2</sup>C BUS INTERFACE

Data transmission from microprocessor to the TDA7476 and viceversa takes place through the 2 wires I<sup>2</sup>C BUS interface, consisting of the two lines SDA and SCL (pull-up resistors to positive supply voltage must be connected).

### Data Validity

As shown by fig. 2, the data on the SDA line must be stable during the high period of the clock. The HIGH and LOW state of the data line can only change when the clock signal on the SCL line is LOW.

### Start and Stop Conditions

As shown by fig. 3 a start condition is a HIGH to LOW transition of the SDA line while SCL is HIGH. The stop condition is a LOW to HIGH transition of the SDA line while SCL is HIGH.

### Byte Format

Every byte transferred to the SDA line must contain 8 bits. Each byte must be followed by an acknowledge bit. The MSB is transferred first.

### Acknowledge

The transmitter\* puts a resistive HIGH level on the SDA line during the acknowledge clock pulse (see fig.4). The receiver\*\* the acknowledges has to pull-down (LOW) the SDA line during the acknowledge clock pulse, so that the SDA line is stable LOW during this clock pulse.

\* Transmitter

- = master ( $\mu$ P) when it writes an address to the TDA7476
- = slave (TDA7476) when the  $\mu$ P reads a data byte from TDA7476

\*\* Receiver

- = slave (TDA7476) when the  $\mu$ P writes an address to the TDA7476
- = master ( $\mu$ P) when it reads a data byte from TDA7476

Figure 2. Data Validity on the I<sup>2</sup>C BUS

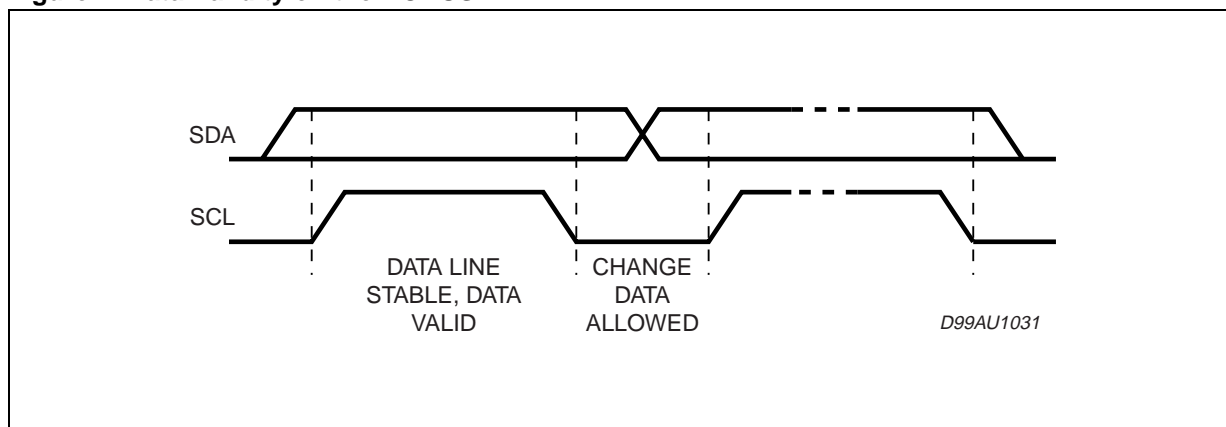



**READ BYTE 1**

| MSB |    |    |    |    |    |    | LSB | STATUS                            |
|-----|----|----|----|----|----|----|-----|-----------------------------------|
| D7  | D6 | D5 | D4 | D3 | D2 | D1 | D0  |                                   |
| X   | X  | X  | X  | 1  | 1  | X  | 0   | CH1 short circuit to Vs           |
| X   | X  | X  | X  | 1  | 1  | 0  | X   | CH1 short circuit to GND          |
| X   | X  | X  | X  | 1  | 0  | 1  | 1   | CH1 open load                     |
| X   | X  | X  | X  | 0  | 1  | 1  | 1   | CH1 short circuit across the load |
| 1   | 1  | X  | 0  | X  | X  | X  | X   | CH2 short circuit to Vs           |
| 1   | 1  | 0  | X  | X  | X  | X  | X   | CH2 short circuit to GND          |
| 1   | 0  | 1  | 1  | X  | X  | X  | X   | CH2 open load                     |
| 0   | 1  | 1  | 1  | X  | X  | X  | X   | CH2 short circuit across the load |

**READ BYTE 2**

|   |   |   |   |   |   |   |   |                                   |
|---|---|---|---|---|---|---|---|-----------------------------------|
| X | X | X | X | 1 | 1 | X | 0 | CH3 short circuit to Vs           |
| X | X | X | X | 1 | 1 | 0 | X | CH3 short circuit to GND          |
| X | X | X | X | 1 | 0 | 1 | 1 | CH3 open load                     |
| X | X | X | X | 0 | 1 | 1 | 1 | CH3 short circuit across the load |
| 1 | 1 | X | 0 | X | X | X | X | CH4 short circuit to Vs           |
| 1 | 1 | 0 | X | X | X | X | X | CH4 short circuit to GND          |
| 1 | 0 | 1 | 1 | X | X | X | X | CH4 open load                     |
| 0 | 1 | 1 | 1 | X | X | X | X | CH4 short circuit across the load |

**READ BYTE 3**

|   |   |   |   |   |   |   |   |                                   |
|---|---|---|---|---|---|---|---|-----------------------------------|
| X | X | X | X | X | X | 1 | 0 | AUX1 short circuit to GND         |
| X | X | X | X | X | X | 0 | 1 | AUX1 open load                    |
| X | X | X | X | 1 | 0 | X | X | AUX2 short circuit to GND         |
| X | X | X | X | 0 | 1 | X | X | AUX2 open load                    |
| 1 | 1 | X | 0 | X | X | X | X | CH5 short circuit to Vs           |
| 1 | 1 | 0 | X | X | X | X | X | CH5 short circuit to GND          |
| 1 | 0 | 1 | 1 | X | X | X | X | CH5 open load                     |
| 0 | 1 | 1 | 1 | X | X | X | X | CH5 short circuit across the load |

When the  $\mu$ P reads correctly all the 3 bytes containing the mentioned information and gives the last acknowledge, the TDA7476 switches to the "permanent diagnostic operation"

**B) PERMANENT DIAGNOSTIC**

It can sense the following diagnostic information:

CH1, CH2, CH3, CH4, CH5

- Short Circuit to GND
- Short Circuit to Vs

Aux1, Aux2

- Short Circuit to GND (\*)
- Open Load (\*)

(\*) Detected if the high side drivers attached to the Aux outputs are ON.

In this case the above conditions are not detected while the single infrasonic current pulse is present but before. The fault condition must be present for more than 2sec. (typ) and must be also true during the pulse, where the data are memorized and then transmitted. The bytes from/to  $\mu$ P and TDA7476 are the same as those in case of turn-on diagnostic (see above).

Here following is the permanent diagnostic output Data Bytes. The bits D7 and D6 of the first byte both stand at 0 level. This condition, although not possible during the turn-on diagnostic, can be useful to confirm that the bytes are referred to the permanent diagnostic.

## READ BYTE 1

| MSB |    |    |    |    |    |    | LSB |                          | STATUS |
|-----|----|----|----|----|----|----|-----|--------------------------|--------|
| D7  | D6 | D5 | D4 | D3 | D2 | D1 | D0  |                          |        |
| 0   | 0  | X  | X  | 1  | 1  | X  | 0   | CH1 short circuit to Vs  |        |
| 0   | 0  | X  | X  | 1  | 1  | 0  | X   | CH1 short circuit to GND |        |
| 0   | 0  | X  | X  | 1  | 1  | 1  | 1   |                          |        |
| 0   | 0  | X  | X  | 1  | 1  | 1  | 1   |                          |        |
| 0   | 0  | X  | 0  | 1  | 1  | X  | X   | CH2 short circuit to Vs  |        |
| 0   | 0  | 0  | X  | 1  | 1  | X  | X   | CH2 short circuit to GND |        |
| 0   | 0  | 1  | 1  | 1  | 1  | X  | X   |                          |        |
| 0   | 0  | 1  | 1  | 1  | 1  | X  | X   |                          |        |

## READ BYTE 2

|   |   |   |   |   |   |   |   |                          |
|---|---|---|---|---|---|---|---|--------------------------|
| 1 | 1 | X | X | 1 | 1 | X | 0 | CH3 short circuit to Vs  |
| 1 | 1 | X | X | 1 | 1 | 0 | X | CH3 short circuit to GND |
| 1 | 1 | X | X | 1 | 1 | 1 | 1 |                          |
| 1 | 1 | X | X | 1 | 1 | 1 | 1 |                          |
| 1 | 1 | X | 0 | 1 | 1 | X | X | CH4 short circuit to Vs  |
| 1 | 1 | 0 | X | 1 | 1 | X | X | CH4 short circuit to GND |
| 1 | 1 | 1 | 1 | 1 | 1 | X | X |                          |
| 1 | 1 | 1 | 1 | 1 | 1 | X | X |                          |

## READ BYTE 3

|   |   |   |   |   |   |   |   |                           |
|---|---|---|---|---|---|---|---|---------------------------|
| 1 | 1 | X | X | X | X | 1 | 0 | AUX1 short circuit to GND |
| 1 | 1 | X | X | X | X | 0 | 1 | AUX1 open load            |
| 1 | 1 | X | X | 1 | 0 | X | X | AUX2 short circuit to GND |
| 1 | 1 | X | X | 0 | 1 | X | X | AUX2 open load            |
| 1 | 1 | X | 0 | X | X | X | X | CH5 short circuit to Vs   |
| 1 | 1 | 0 | X | X | X | X | X | CH5 short circuit to GND  |
| 1 | 1 | 1 | 1 | X | X | X | X |                           |
| 1 | 1 | 1 | 1 | X | X | X | X |                           |

**Repetitive turn-on diagnostic**

During the turn-on diagnostic, the TDA7476 can reveal false "short circuit across load" and/or false "open load" due to noise sources such as door slams.

This problem can be solved doing more than one turn-on diagnostic routine. If the  $\mu$ P asks for N times the state of the audio system, it has to consider a fault as really present only if it is detected in all the N turn-on diagnostics. As above explained, the first time the TDA7476 receives the byte ADD1, it does the turn-on diagnostic; then each time it is addressed with ADD1, it does the permanent diagnostic. This is not true if, when the  $\mu$ P sends for the first time the byte ADD2, it does not send to the TDA7476 the acknowledge after it has received the byte BYTE3. In this case, the TDA7476 does not switch from turn-on to permanent diagnostic mode so if it receives again the byte ADD1 it works as it was the first time that it does the turn-on diagnostic. In order to do repetitive turn-on diagnostic, the  $\mu$ P has to be programmed as following:

- Step 1: the  $\mu$ P sends ADD1

|       |      |     |     |
|-------|------|-----|-----|
| START | ADD1 | ACK | ACK |
|-------|------|-----|-----|

- Step 2: the  $\mu$ P waits  $T_{wait1}$  seconds

- Step 3: the  $\mu$ P sends ADD2, receives BYTE1, BYTE2, BYTE3, **does not send the acknowledge after BYTE3**

## TDA7476

---

|       |      |     |       |     |       |     |       |      |
|-------|------|-----|-------|-----|-------|-----|-------|------|
| START | ADD2 | ACK | BYTE1 | ACK | BYTE2 | ACK | BYTE3 | STOP |
|-------|------|-----|-------|-----|-------|-----|-------|------|

- Step 4: repeat Step1, Step2, Step3 while the second, third, fourth, ...turn-on diagnostic has to be done. During **the last turn-on diagnostic** the  $\mu$ P sends ADD2, receives BYTE1, BYTE2, BYTE3, and **sends the acknowledge after BYTE3**

|       |      |     |       |     |       |     |       |     |      |
|-------|------|-----|-------|-----|-------|-----|-------|-----|------|
| START | ADD2 | ACK | BYTE1 | ACK | BYTE2 | ACK | BYTE3 | ACK | STOP |
|-------|------|-----|-------|-----|-------|-----|-------|-----|------|

In this way only after that the TDA7476 has done for N times the turn-on diagnostic, it switches from turn-on to permanent diagnostic mode. From now the TDA7476 always does the permanent diagnostic. To save time when the audio system is switched on, it is possible to do the repetitive turn-on diagnostic when the car-radio is turned off. In this case the steps to follow to do the repetitive turn-on diagnostic are the following:

- 1- to switch off the TDA7476 connecting STBY pin to ground;
- 2- to wait  $T_{5V}$  seconds (time necessary for the discharge of the capacitor). If  $C_{5V} = 10\mu F$  then  $T_{5V} = 20ms$  typ;
- 3- to switch on the TDA7476
- 4- to do the repetitive turn-on diagnostic as above described;
- 5- to turn off the TDA7476.

### WARNING PIN

- This is an open drain output pin that is activated when a fault condition is present for more than 2 sec (TYP). The fault conditions related to the warning pin are as follows:
  - AUX1, AUX2  
Short to GND
  - CH1, CH2, CH3, CH4, CH5:  
Short Circuit to GND  
Short Circuit to  $V_s$
- The purpose of this pin is to alert the  $\mu$ P and start with the permanent diagnostic routine only if faults are present, thus avoiding CPU's waste of time.

## APPLICATION NOTES

■ When **single-ended** devices are used and the application circuit is as shown in fig. 7,8, it is necessary to use:

- a greater timing capacitor so that the time  $t_m$  is high and the outputs of the amplifiers are able to rise over 1V;
- a resistor  $R_{CS}$  1.5 times higher than that used for the bridge amplifiers.

In this case, the loudspeaker resistance ranges in which short circuit, normal operation and open load are detected will be as follows:

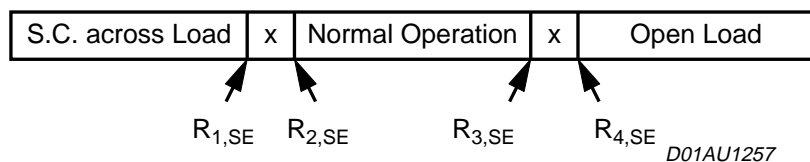

$$R_{1,SE} = \frac{L_{SC,max}}{I_{source}} = \frac{L_{SC,max}}{54.45} \cdot R_{CS}$$

$$R_{2,SE} = \frac{L_{SC,min}}{I_{source}} = \frac{L_{nop,min}}{54.45} \cdot R_{CS}$$

$$R_{3,SE} = \frac{L_{nop,max}}{I_{source}} = \frac{L_{nop,max}}{54.45} \cdot R_{CS}$$

$$R_{4,SE} = \frac{L_{op,min}}{I_{source}} = \frac{L_{op,min}}{54.45} \cdot R_{CS}$$

For example, here below are two cases, with  $R_{CS} = 4.7k\Omega$  and  $R_{CS} = 2.7k\Omega$ .

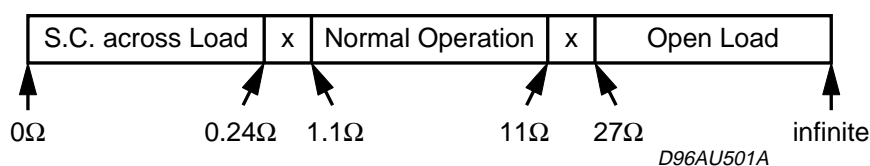
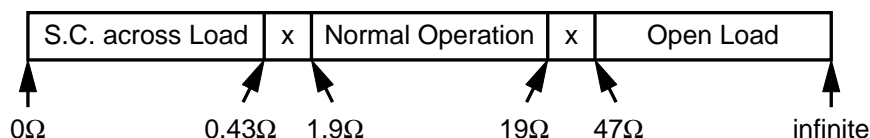

The exact values of the above mentioned resistive ranges may vary a little, depending on the power amplifier used

In Permanent mode for single-ended devices as in fig. 7, 8 a short circuit to ground is detected both when a short to ground is really present and when the load is missing.

On single-ended devices as in figure 6, 8 if the loads are present then both in turn-on and in permanent diagnostic the fault present on one channel is pointed out for all the loads connected together. For example:

- see fig.8 if CH1+ is shorted to ground, the TDA7476 reveals a short to ground both for CH2 and for CH1.
- see fig.6 if CH1+ is shorted to ground, the TDA7476 detects a short circuit to ground for CH1, CH2, CH3, CH4.

About timing for the TDA7375, connected as in fig.7,  $C_t = 47\mu F$  if  $C_{out} = 1000\mu F$ , and  $C_t = 100\mu F$  if  $C_{out} = 2200\mu F$ .

If the circuit is as shown by fig. 8, the suggested values of  $C_t$  are as follows:  $C_t = 22\mu F$  if  $C_{out} = 1000\mu F$ ,  $C_t = 47\mu F$  if  $C_{out} = 2200\mu F$ .

## TDA7476

- To use the TDA7476 with a car-radio system which has less than five audio channel and less than two auxiliary loads, it is necessary to take some cares:
    - each pin CH± not used has to be fixed to 5V
    - each pin AUX1IN, AUX1OUT, AUXIN2, AUX2OUT not used has to be fixed to a voltage equal or greater than 5V
- The 5V voltage reference available on the chip (pin 10) is very useful to fix both CH± and AUX pins to 5V.

### APPLICATION EXAMPLES WITH ST AUDIO POWER ICs

**Figure 5. Quad Bridge Amplifiers**

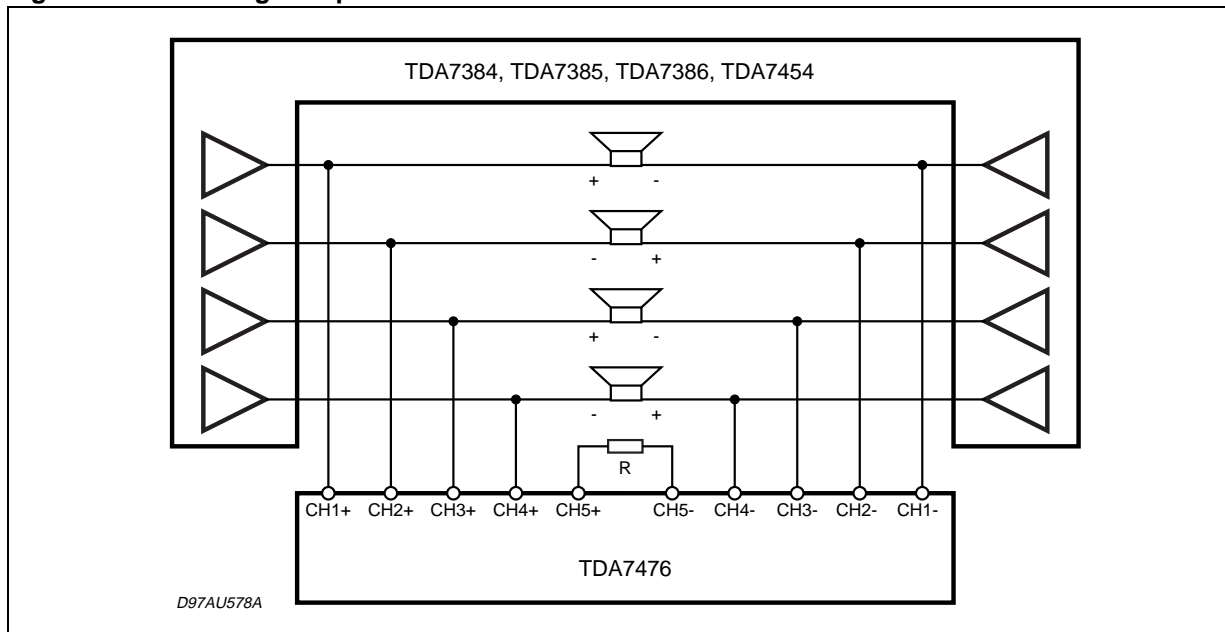

**Figure 6. TDA7451**

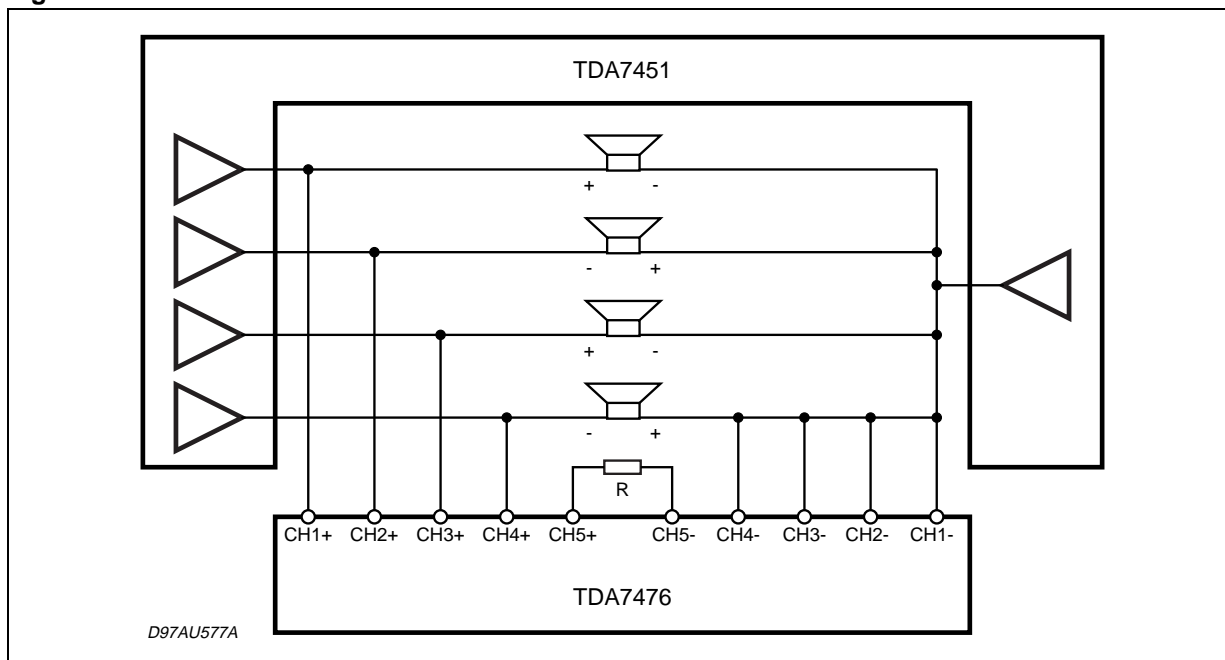



Figure 7. TDA7375 in S.E. mode with 4 output capacitors

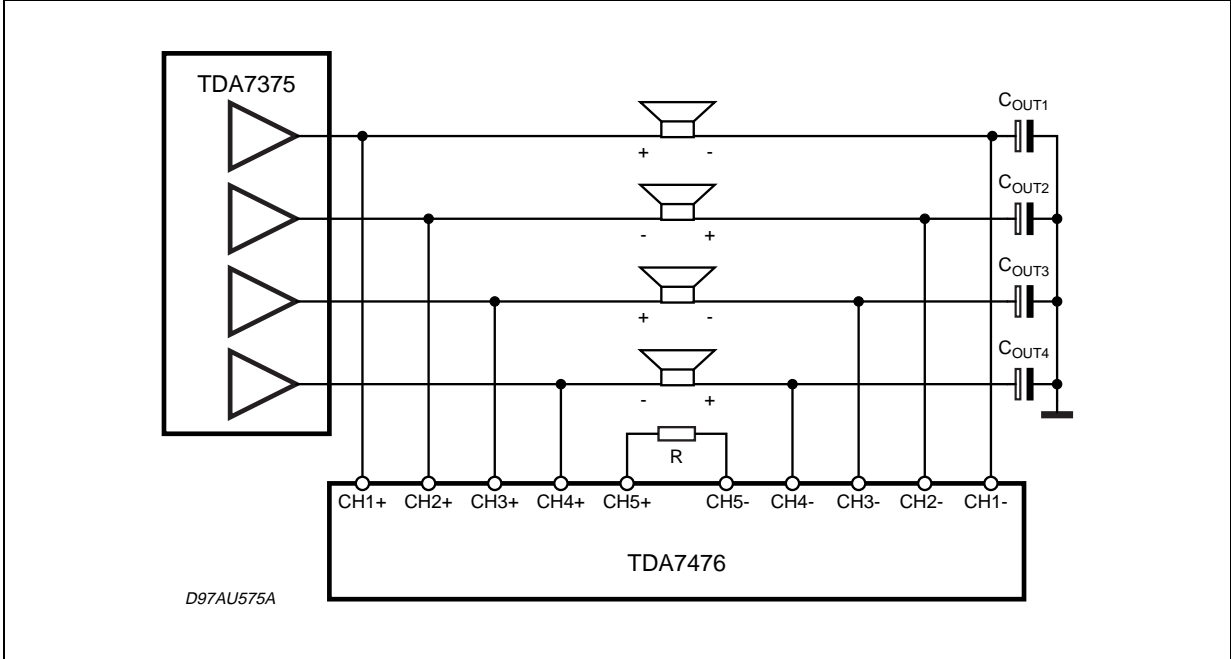
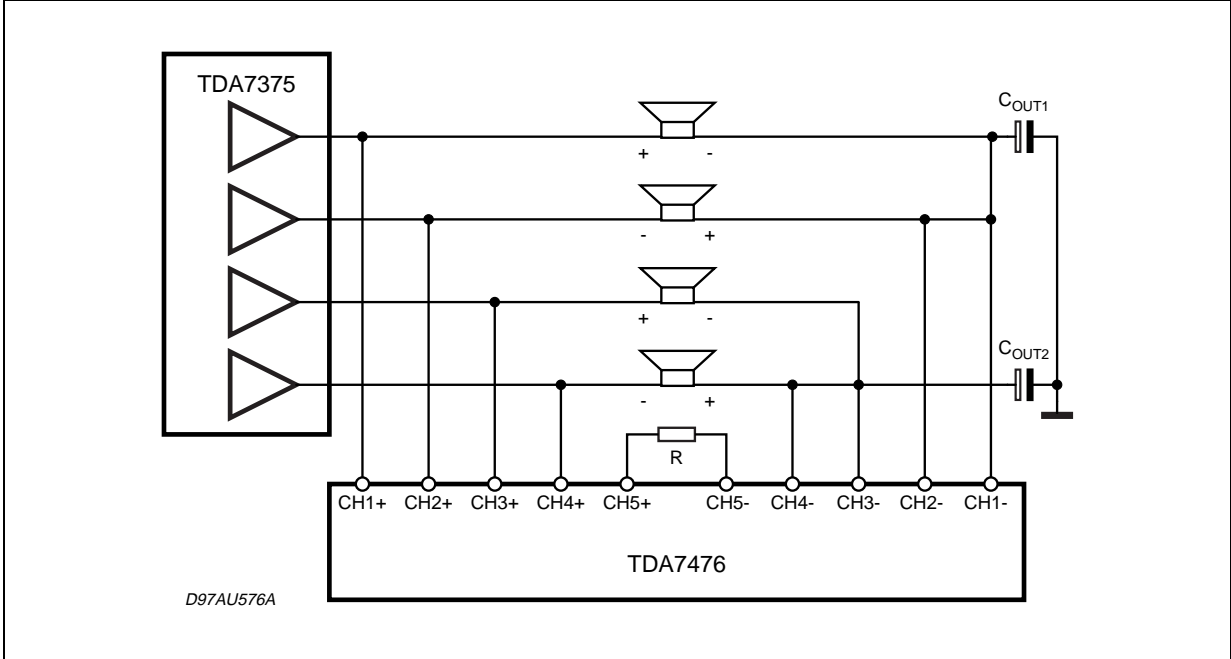
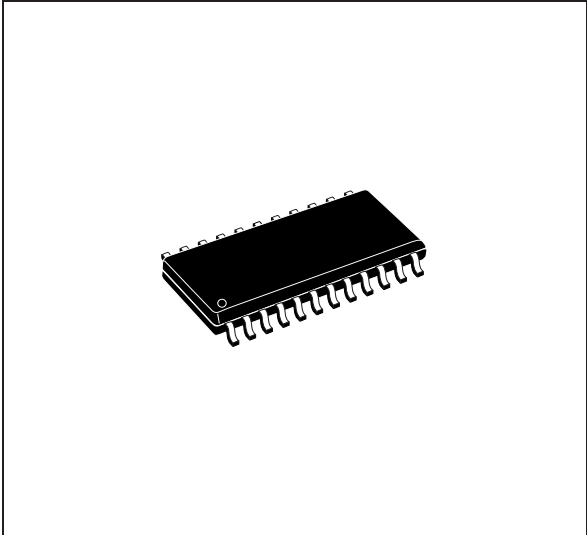

Figure 8. TDA7375 in S.E. mode with 2 output capacitors



| DIM. | mm                   |      |       | inch  |       |        |
|------|----------------------|------|-------|-------|-------|--------|
|      | MIN.                 | TYP. | MAX.  | MIN.  | TYP.  | MAX.   |
| A    | 2.35                 |      | 2.65  | 0.093 |       | 0.104  |
| A1   | 0.10                 |      | 0.30  | 0.004 |       | 0.012  |
| A2   |                      |      | 2.55  |       |       | 0.100  |
| B    | 0.33                 |      | 0.51  | 0.013 |       | 0.0200 |
| C    | 0.23                 |      | 0.32  | 0.009 |       | 0.013  |
| D    | 15.20                |      | 15.60 | 0.598 |       | 0.614  |
| E    | 7.40                 |      | 7.60  | 0.291 |       | 0.299  |
| e    |                      | 1.27 |       |       | 0,050 |        |
| H    | 10.0                 |      | 10.65 | 0.394 |       | 0.419  |
| h    | 0.25                 |      | 0.75  | 0.010 |       | 0.030  |
| k    | 0° (min.), 8° (max.) |      |       |       |       |        |
| L    | 0.40                 |      | 1.27  | 0.016 |       | 0.050  |

**OUTLINE AND MECHANICAL DATA**



**SO24**

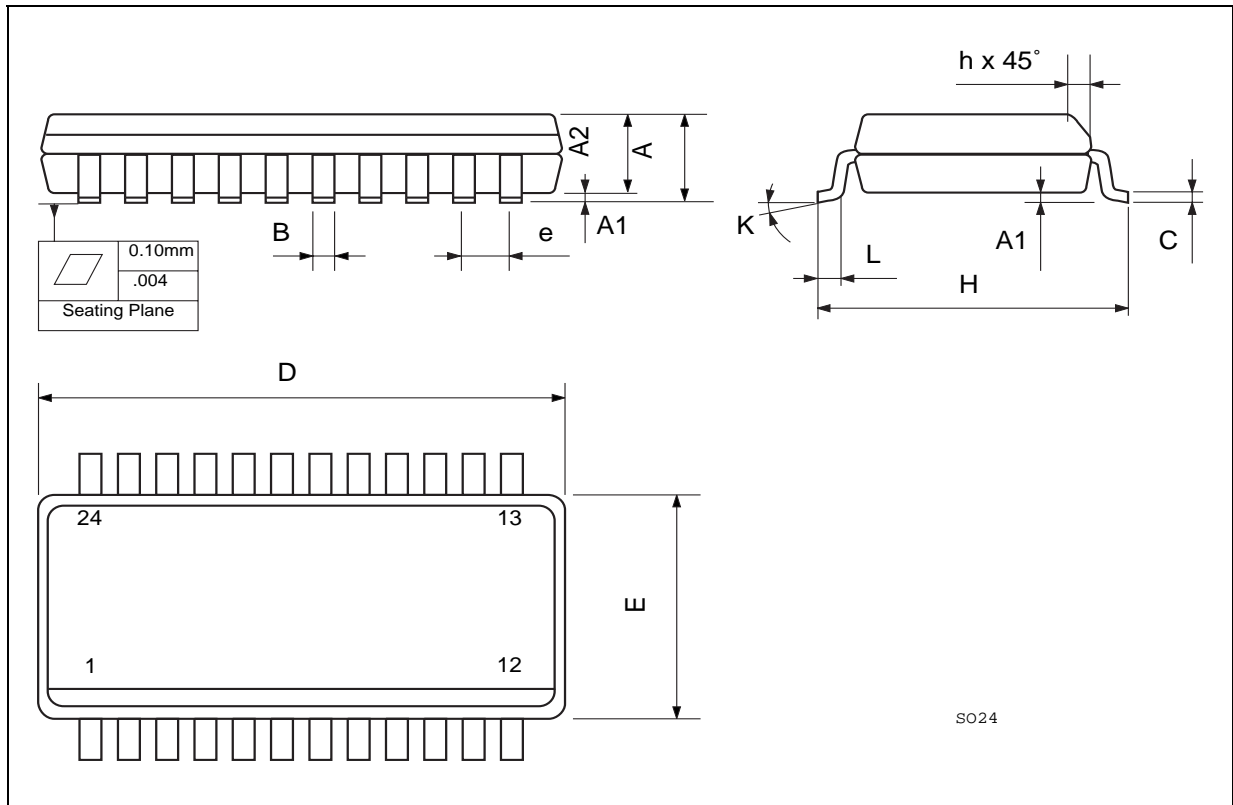

Information furnished is believed to be accurate and reliable. However, STMicroelectronics assumes no responsibility for the consequences of use of such information nor for any infringement of patents or other rights of third parties which may result from its use. No license is granted by implication or otherwise under any patent or patent rights of STMicroelectronics. Specifications mentioned in this publication are subject to change without notice. This publication supersedes and replaces all information previously supplied. STMicroelectronics products are not authorized for use as critical components in life support devices or systems without express written approval of STMicroelectronics.

The ST logo is a registered trademark of STMicroelectronics  
© 2001 STMicroelectronics - All Rights Reserved

STMicroelectronics GROUP OF COMPANIES  
Australia - Brazil - China - Finland - France - Germany - Hong Kong - India - Italy - Japan - Malaysia - Malta - Morocco - Singapore - Spain  
- Sweden - Switzerland - United Kingdom - U.S.A.  
<http://www.st.com>



Компания «ЭлектроПласт» предлагает заключение долгосрочных отношений при поставках импортных электронных компонентов на взаимовыгодных условиях!

Наши преимущества:

- Оперативные поставки широкого спектра электронных компонентов отечественного и импортного производства напрямую от производителей и с крупнейших мировых складов;
- Поставка более 17-ти миллионов наименований электронных компонентов;
- Поставка сложных, дефицитных, либо снятых с производства позиций;
- Оперативные сроки поставки под заказ (от 5 рабочих дней);
- Экспресс доставка в любую точку России;
- Техническая поддержка проекта, помощь в подборе аналогов, поставка прототипов;
- Система менеджмента качества сертифицирована по Международному стандарту ISO 9001;
- Лицензия ФСБ на осуществление работ с использованием сведений, составляющих государственную тайну;
- Поставка специализированных компонентов (Xilinx, Altera, Analog Devices, Intersil, Interpoint, Microsemi, Aeroflex, Peregrine, Syfer, Eurofarad, Texas Instrument, Miteq, Cobham, E2V, MA-COM, Hittite, Mini-Circuits, General Dynamics и др.);

Помимо этого, одним из направлений компании «ЭлектроПласт» является направление «Источники питания». Мы предлагаем Вам помощь Конструкторского отдела:

- Подбор оптимального решения, техническое обоснование при выборе компонента;
- Подбор аналогов;
- Консультации по применению компонента;
- Поставка образцов и прототипов;
- Техническая поддержка проекта;
- Защита от снятия компонента с производства.



#### Как с нами связаться

**Телефон:** 8 (812) 309 58 32 (многоканальный)

**Факс:** 8 (812) 320-02-42

**Электронная почта:** [org@eplast1.ru](mailto:org@eplast1.ru)

**Адрес:** 198099, г. Санкт-Петербург, ул. Калинина, дом 2, корпус 4, литера А.