

# General Specifications

Toggles

Rockers  
B

Pushbuttons

Illuminated PB

Programmable

Keylocks

Rotaries

Slides

Tactiles

Tilt

Touch

Indicators

Accessories

Supplement

## Electrical Capacity (Resistive Load)

**Logic Level:** 0.4VA maximum @ 28V AC/DC maximum  
(Applicable Range 0.1mA ~ 0.1A @ 20mV ~ 28V)  
Note: Find additional explanation of operating range in Supplement section.

## Other Ratings

**Contact Resistance:** 80 milliohms maximum  
**Insulation Resistance:** 500 megohms minimum @ 500V DC  
**Dielectric Strength:** 500V AC minimum for 1 minute minimum  
**Mechanical Life:** 100,000 operations minimum for On-None-On & On-Off-On  
 50,000 operations minimum for other circuits  
**Electrical Life:** 100,000 operations minimum for On-None-On & On-Off-On  
 50,000 operations minimum for other circuits  
**Nominal Operating Force:** .81N for momentary & 1.06N for maintained  
**Angle of Throw:** 28°

## Materials & Finishes

**Actuator:** Glass fiber reinforced polyamide  
**Case:** Glass fiber reinforced polyamide  
**Sealing Rings:** Nitrile butadiene rubber  
**Movable Contact:** Phosphor bronze with gold plating  
**Stationary Contacts:** Phosphor bronze with gold plating  
**Base:** Glass fiber reinforced polyamide  
**Terminals:** Phosphor bronze with gold plating

## Environmental Data

**Operating Temperature Range:** -25°C through +85°C (-13°F through +185°F)  
**Humidity:** 90 ~ 95% humidity for 96 hours @ 40°C (104°F)  
**Vibration:** 10 ~ 55Hz with peak-to-peak amplitude of 1.5mm traversing the frequency range & returning in 1 minute; 3 right angled directions for 2 hours  
**Shock:** 50G (490m/s<sup>2</sup>) acceleration (tested in 6 right angled directions, with 5 shocks in each direction)

## Installation

**Cap Installation Force:** 39.1N (8.8 lbf) maximum downward force on actuator

## PCB Processing

**Soldering:** Wave Soldering Recommended: See Profile A in Supplement section.  
 Manual Soldering: See Profile A in Supplement section.  
**Cleaning:** Automated cleaning. See Cleaning specifications in Supplement section.

## Standards & Certifications

The G Series rockers have not been tested for UL recognition or CSA certification. These switches are designed for use in a low-voltage, low-current, logic-level circuit. When used as intended in a logic-level circuit, the results do not produce hazardous energy.

# Distinctive Characteristics

Ultra-miniature size allows high density mounting, and extremely light weight of 0.25 gram makes these switches ideal for handheld equipment.

Totally sealed body construction prevents contact contamination and allows time-and money-saving automated soldering and cleaning.

Award-winning STC contact mechanism with benefits unavailable in conventional mechanisms: smoother, positive detent actuation, increased contact stability and unparalleled logic-level reliability. (Additional STC details in Terms & Acronyms; see Supplement section.)

.100" x .100" (2.54mm x 2.54mm) terminal spacing conforms to standard PC board grid spacing. Round terminals facilitate easier through-hole mounting on PC boards.

Matching indicators available.

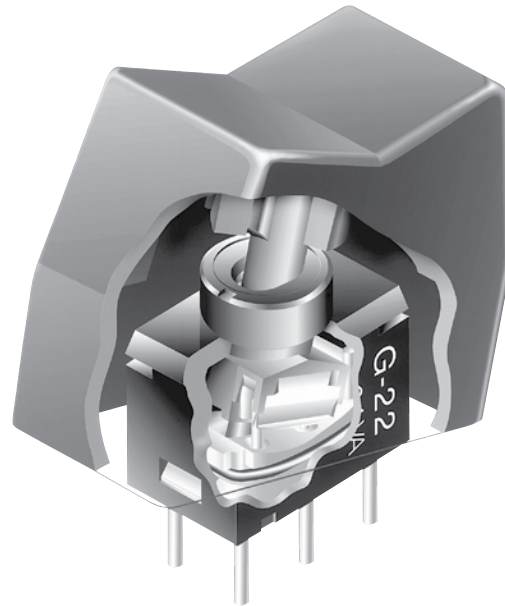

Actual Size

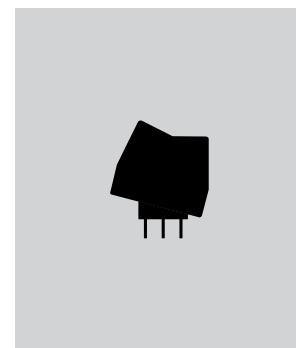

Supplement

- Accessories
- Indicators
- Touch
- Tilt
- Tactiles
- Slides
- Rotaries
- Keylocks
- Programmable
- Illuminated PB
- Pushbuttons
- B** Rockers
- Toggle

### TYPICAL SWITCH ORDERING EXAMPLE

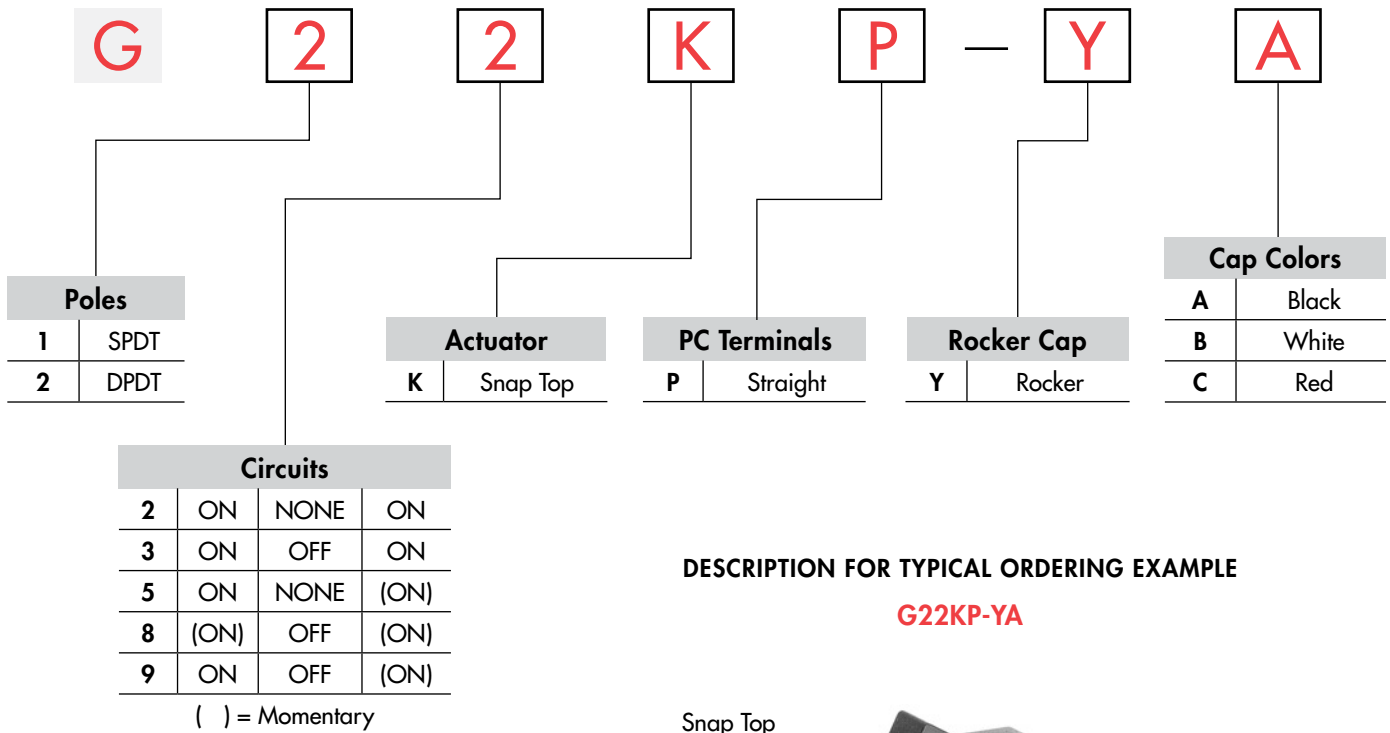

### DESCRIPTION FOR TYPICAL ORDERING EXAMPLE

**G22KP-YA**

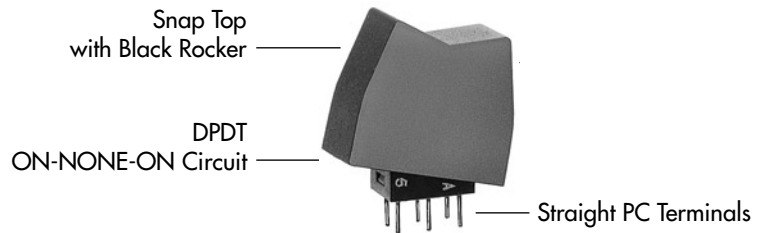

### POLES & CIRCUITS

Pole	Model	Rocker Position ( ) = Momentary			Connected Terminals			Throw & Schematics
		Up	Center	Down	Up	Center	Down	
SP	G12 G13 G15 G18 G19	ON ON ON (ON) ON	NONE OFF NONE OFF OFF	ON ON (ON) (ON) (ON)	5-6	OPEN	5-4	SPDT 
DP	G22 G23 G25 G28 G29	ON ON ON (ON) ON	NONE OFF NONE OFF OFF	ON ON (ON) (ON) (ON)	5-6 2-3	OPEN	5-4 2-1	DPDT 

ACTUATOR

**K** Snap Top for Rocker

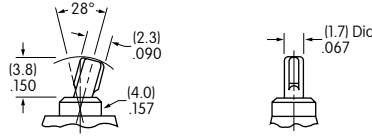

PC TERMINALS

**P** Straight

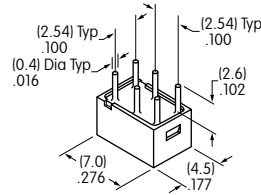

ROCKER CAP & COLORS

**Y** AT4062 Rocker

Material: Polyamide  
Finish: Matte

Colors Available:  
A, B, C

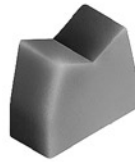

Actual Size

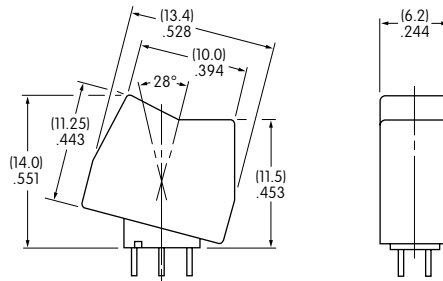

Color Codes: **A** Black **B** White **C** Red

TYPICAL SWITCH DIMENSIONS

Single & Double Pole

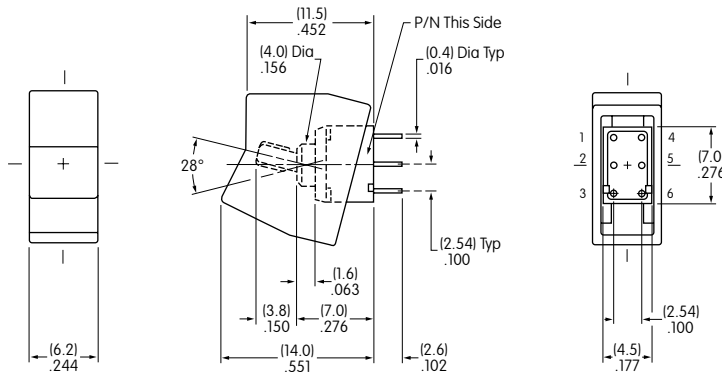

Straight PC

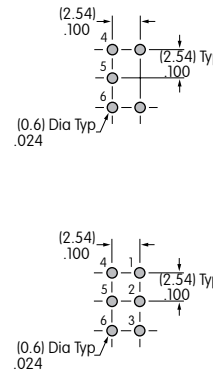

On single pole models positions 1 & 3 are support pins.

G23KP-YA



Компания «ЭлектроПласт» предлагает заключение долгосрочных отношений при поставках импортных электронных компонентов на взаимовыгодных условиях!

Наши преимущества:

- Оперативные поставки широкого спектра электронных компонентов отечественного и импортного производства напрямую от производителей и с крупнейших мировых складов;
- Поставка более 17-ти миллионов наименований электронных компонентов;
- Поставка сложных, дефицитных, либо снятых с производства позиций;
- Оперативные сроки поставки под заказ (от 5 рабочих дней);
- Экспресс доставка в любую точку России;
- Техническая поддержка проекта, помощь в подборе аналогов, поставка прототипов;
- Система менеджмента качества сертифицирована по Международному стандарту ISO 9001;
- Лицензия ФСБ на осуществление работ с использованием сведений, составляющих государственную тайну;
- Поставка специализированных компонентов (Xilinx, Altera, Analog Devices, Intersil, Interpoint, Microsemi, Aeroflex, Peregrine, Syfer, Eurofarad, Texas Instrument, Miteq, Cobham, E2V, MA-COM, Hittite, Mini-Circuits, General Dynamics и др.);

Помимо этого, одним из направлений компании «ЭлектроПласт» является направление «Источники питания». Мы предлагаем Вам помощь Конструкторского отдела:

- Подбор оптимального решения, техническое обоснование при выборе компонента;
- Подбор аналогов;
- Консультации по применению компонента;
- Поставка образцов и прототипов;
- Техническая поддержка проекта;
- Защита от снятия компонента с производства.



#### Как с нами связаться

**Телефон:** 8 (812) 309 58 32 (многоканальный)

**Факс:** 8 (812) 320-02-42

**Электронная почта:** [org@eplast1.ru](mailto:org@eplast1.ru)

**Адрес:** 198099, г. Санкт-Петербург, ул. Калинина, дом 2, корпус 4, литера А.