

Silicon carbide Power MOSFET 1200 V, 45 A, 90 mΩ (typ.,  $T_J = 150\text{ }^\circ\text{C}$ ), in an HiP247™ long leads package

Datasheet - production data

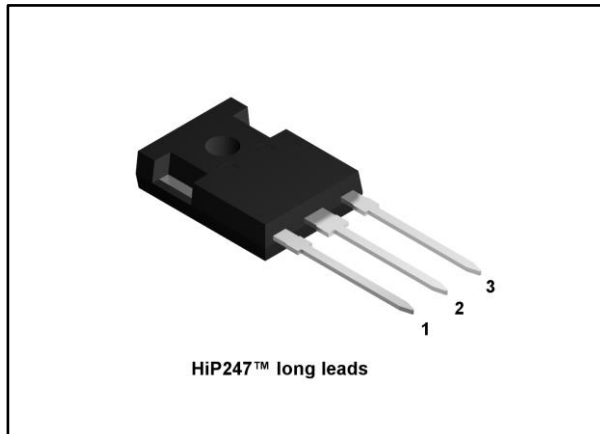
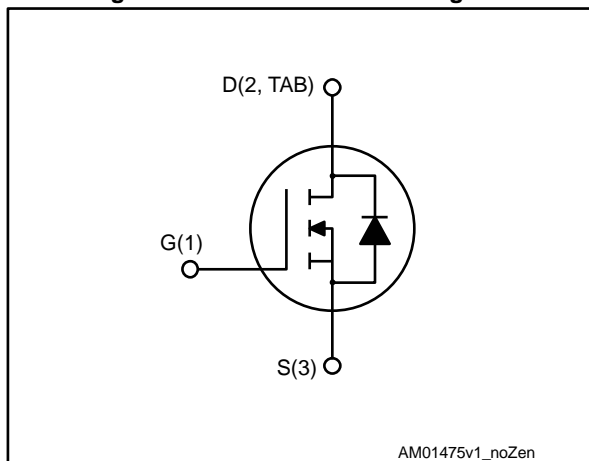

Figure 1: Internal schematic diagram



## Features

- Very tight variation of on-resistance vs. temperature
- Very high operating junction temperature capability ( $T_J = 200\text{ }^\circ\text{C}$ )
- Very fast and robust intrinsic body diode
- Low capacitance

## Applications

- Solar inverters, UPS
- Motor drives
- High voltage DC-DC converters
- Switch mode power supply

## Description

This silicon carbide Power MOSFET is produced exploiting the advanced, innovative properties of wide bandgap materials. This results in unsurpassed on-resistance per unit area and very good switching performance almost independent of temperature. The outstanding thermal properties of the SiC material allow designers to use an industry-standard outline with significantly improved thermal capability. These features render the device perfectly suitable for high-efficiency and high power density applications.

Table 1: Device summary

Order code	Marking	Package	Packaging
SCTWA30N120	SCT30N120	HiP247™ long leads	Tube

---

## Contents

<b>1</b>	<b>Electrical ratings .....</b>	<b>3</b>
<b>2</b>	<b>Electrical characteristics .....</b>	<b>4</b>
	2.1 Electrical characteristics (curves).....	6
<b>3</b>	<b>Package information .....</b>	<b>10</b>
	3.1 HiP247 long leads package information.....	10
<b>4</b>	<b>Revision history .....</b>	<b>12</b>

# 1 Electrical ratings

**Table 2: Absolute maximum ratings**

Symbol	Parameter	Value	Unit
$V_{DS}$	Drain-source voltage	1200	V
$V_{GS}$	Gate-source voltage	-10 to 25	V
$I_D$	Drain current (continuous) at $T_C = 25\text{ °C}$ (limited by die)	45	A
$I_D$	Drain current (continuous) at $T_C = 25\text{ °C}$ (limited by package)	40	A
$I_D$	Drain current (continuous) at $T_C = 100\text{ °C}$	34	A
$I_{DM}^{(1)}$	Drain current (pulsed)	90	A
$P_{TOT}$	Total dissipation at $T_C = 25\text{ °C}$	270	W
$T_{stg}$	Storage temperature range	-55 to 200	°C
$T_j$	Operating junction temperature range		

**Notes:**

<sup>(1)</sup>Pulse width limited by safe operating area.

**Table 3: Thermal data**

Symbol	Parameter	Value	Unit
$R_{thj-case}$	Thermal resistance junction-case	0.65	°C/W
$R_{thj-amb}$	Thermal resistance junction-amb	40	°C/W

## 2 Electrical characteristics

( $T_{\text{case}} = 25\text{ °C}$  unless otherwise specified)

**Table 4: On /off states**

Symbol	Parameter	Test conditions	Min.	Typ.	Max.	Unit
$I_{\text{DSS}}$	Zero gate voltage drain current	$V_{\text{GS}} = 0\text{ V}$ , $V_{\text{DS}} = 1200\text{ V}$		1	25	$\mu\text{A}$
		$V_{\text{GS}} = 0\text{ V}$ , $V_{\text{DS}} = 1200\text{ V}$ , $T_{\text{J}} = 200\text{ °C}$		50		$\mu\text{A}$
$I_{\text{GSS}}$	Gate-body leakage current	$V_{\text{DS}} = 0\text{ V}$ , $V_{\text{GS}} = -10\text{ to }22\text{ V}$			$\pm 100$	nA
$V_{\text{GS(th)}}$	Gate threshold voltage	$V_{\text{DS}} = V_{\text{GS}}$ , $I_{\text{D}} = 1\text{ mA}$	1.8	3.5		V
$R_{\text{DS(on)}}$	Static drain-source on-resistance	$V_{\text{GS}} = 20\text{ V}$ , $I_{\text{D}} = 20\text{ A}$		80	100	m $\Omega$
		$V_{\text{GS}} = 20\text{ V}$ , $I_{\text{D}} = 20\text{ A}$ $T_{\text{J}} = 150\text{ °C}$		90		m $\Omega$
		$V_{\text{GS}} = 20\text{ V}$ , $I_{\text{D}} = 20\text{ A}$ $T_{\text{J}} = 200\text{ °C}$		100		m $\Omega$

**Table 5: Dynamic**

Symbol	Parameter	Test conditions	Min.	Typ.	Max.	Unit
$C_{\text{iss}}$	Input capacitance	$V_{\text{GS}} = 0\text{ V}$ , $V_{\text{DS}} = 400\text{ V}$ , $f = 1\text{ MHz}$	-	1700	-	pF
$C_{\text{oss}}$	Output capacitance		-	130	-	pF
$C_{\text{rss}}$	Reverse transfer capacitance		-	25	-	pF
$R_{\text{G}}$	Intrinsic gate resistance	$f = 1\text{ MHz}$ , $I_{\text{D}} = 0\text{ A}$	-	5	-	$\Omega$
$Q_{\text{g}}$	Total gate charge	$V_{\text{DD}} = 800\text{ V}$ , $I_{\text{D}} = 20\text{ A}$ $V_{\text{GS}} = 0\text{ to }20\text{ V}$	-	105	-	nC
$Q_{\text{gs}}$	Gate-source charge		-	16	-	nC
$Q_{\text{gd}}$	Gate-drain charge		-	40	-	nC

**Table 6: Switching energy (inductive load)**

Symbol	Parameter	Test conditions	Min.	Typ.	Max	Unit
$E_{\text{on}}$	Turn-on switching energy	$V_{\text{DD}} = 800\text{ V}$ , $I_{\text{D}} = 20\text{ A}$ , $R_{\text{G}} = 6.8\text{ }\Omega$ , $V_{\text{GS}} = -2\text{ to }20\text{ V}$	-	500	-	$\mu\text{J}$
$E_{\text{off}}$	Turn-off switching energy		-	350	-	$\mu\text{J}$
$E_{\text{on}}$	Turn-on switching energy	$V_{\text{DD}} = 800\text{ V}$ , $I_{\text{D}} = 20\text{ A}$ , $R_{\text{G}} = 6.8\text{ }\Omega$ , $V_{\text{GS}} = -2\text{ to }20\text{ V}$ $T_{\text{J}} = 150\text{ °C}$	-	500	-	$\mu\text{J}$
$E_{\text{off}}$	Turn-off switching energy		-	400	-	$\mu\text{J}$

**Table 7: Switching times**

Symbol	Parameter	Test conditions	Min.	Typ.	Max	Unit
$t_{\text{d(on)V}}$	Turn-on delay time	$V_{\text{DD}} = 800\text{ V}$ , $I_{\text{D}} = 20\text{ A}$ , $R_{\text{G}} = 0\text{ }\Omega$ , $V_{\text{GS}} = 0\text{ to }20\text{ V}$	-	19	-	ns
$t_{\text{f(V)}}$	Fall time		-	28	-	ns
$t_{\text{d(off)V}}$	Turn-off-delay time		-	45	-	ns
$t_{\text{r(V)}}$	Rise time		-	20	-	ns

Table 8: Reverse SiC diode characteristics

Symbol	Parameter	Test conditions	Min.	Typ.	Max	Unit
$V_{SD}$	Diode forward voltage	$I_F = 10\text{ A}$ , $V_{GS} = 0\text{ V}$	-	3.5	-	V
$t_{rr}$	Reverse recovery time	$I_{SD} = 20\text{ A}$ , $di/dt = 100\text{ A}/\mu\text{s}$ $V_{DD} = 800\text{ V}$	-	140	-	ns
$Q_{rr}$	Reverse recovery charge		-	140		nC
$I_{RRM}$	Reverse recovery current		-	2		A

## 2.1 Electrical characteristics (curves)

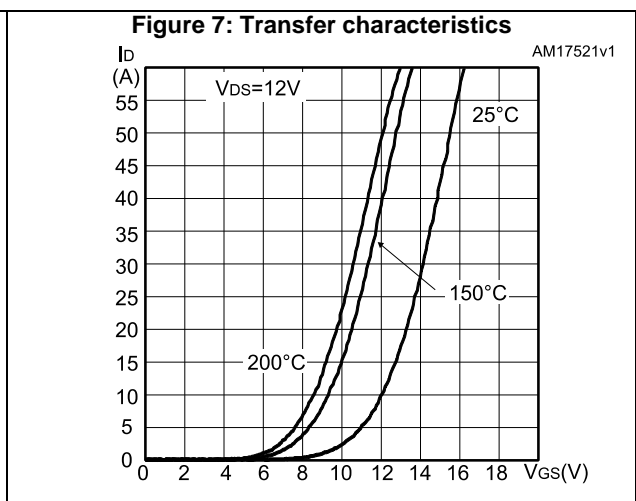
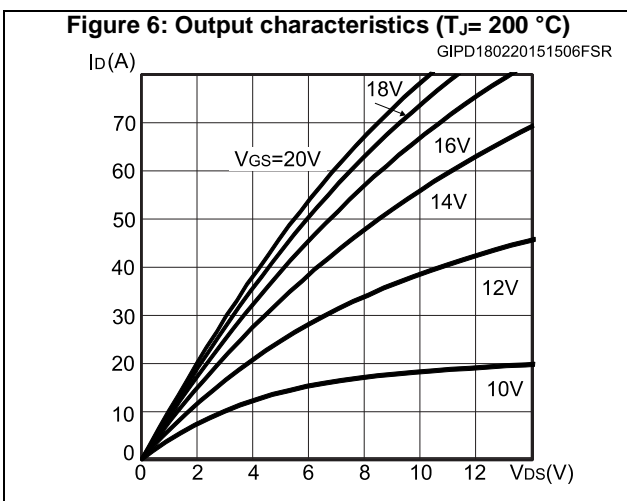
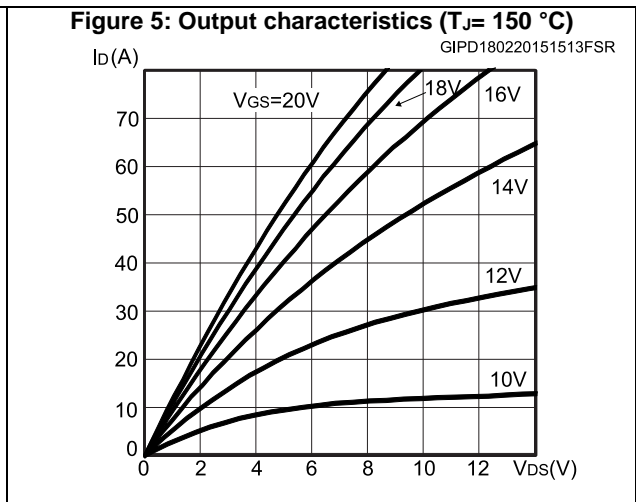
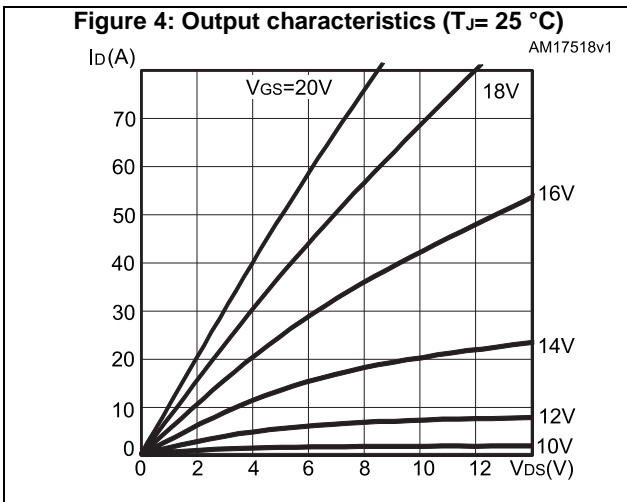
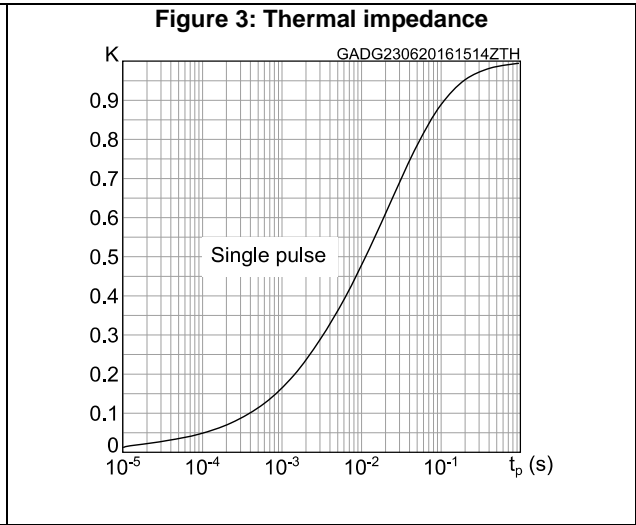
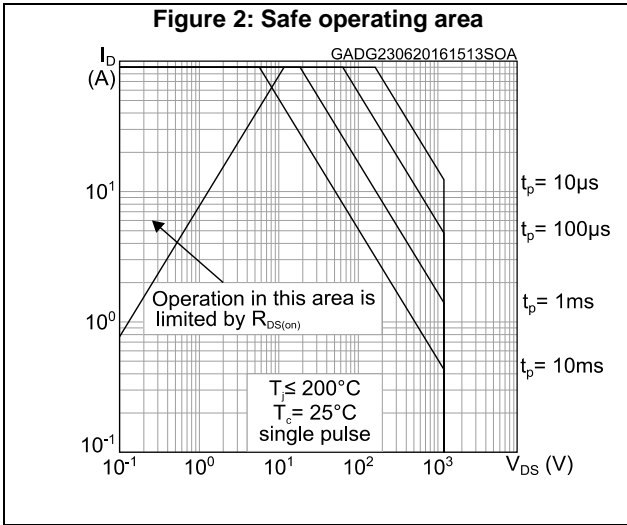

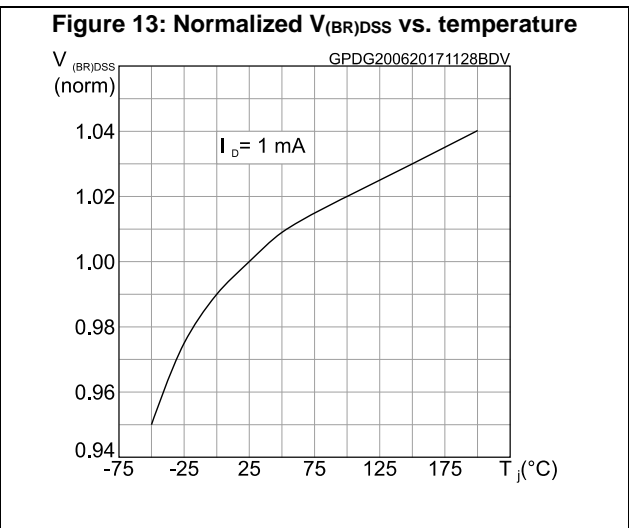
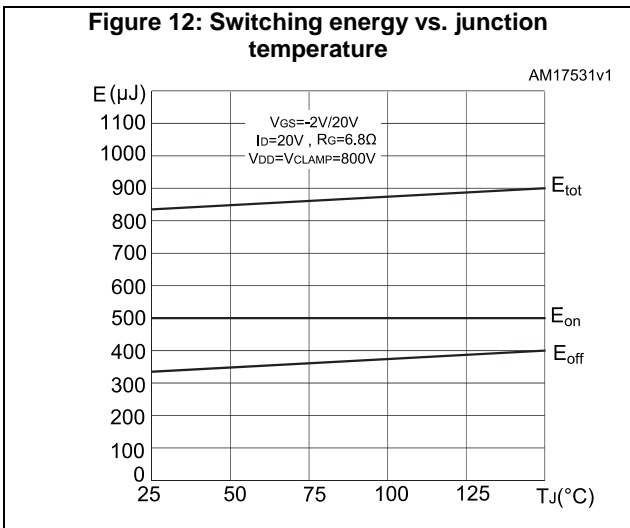
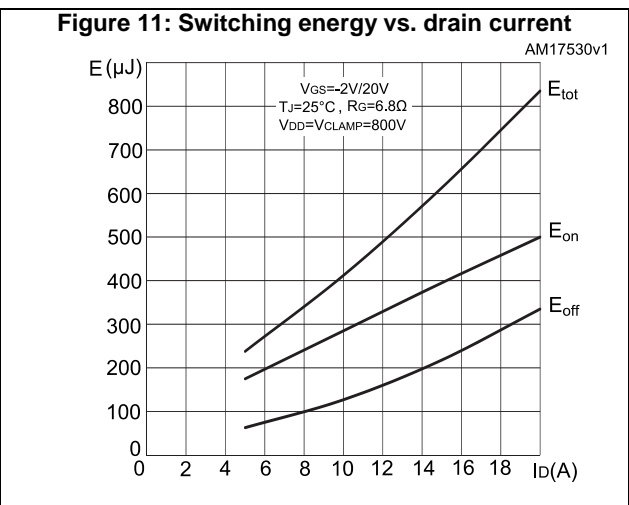
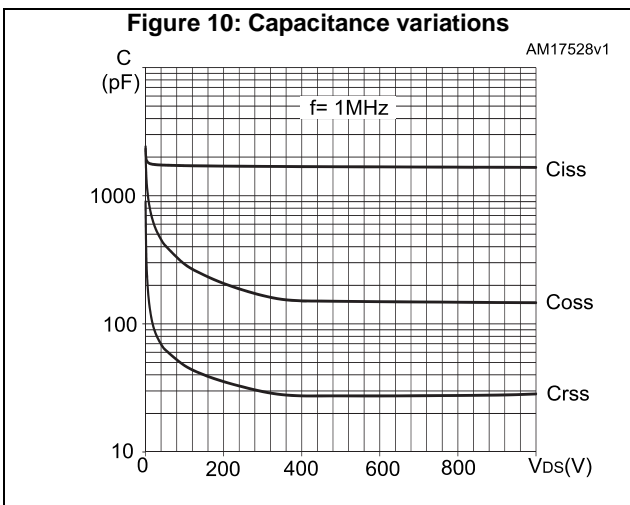
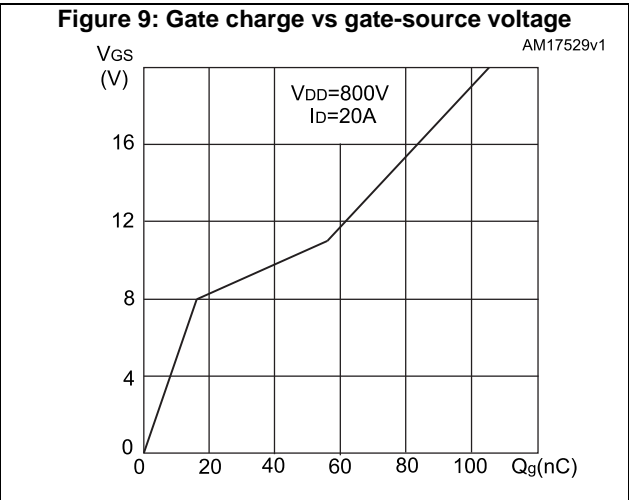
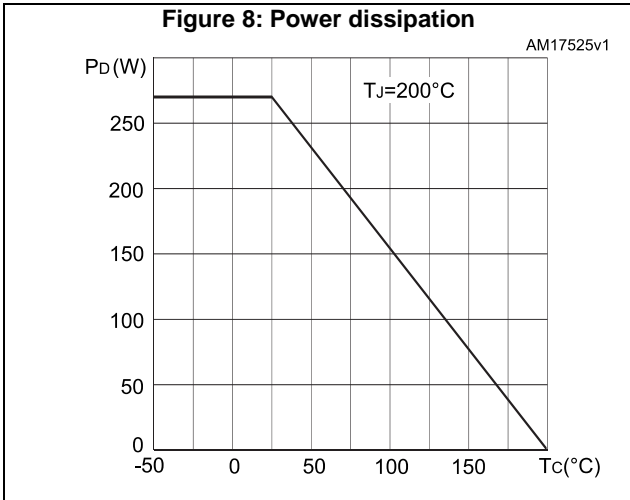

Figure 14: Normalized gate threshold voltage vs. temperature

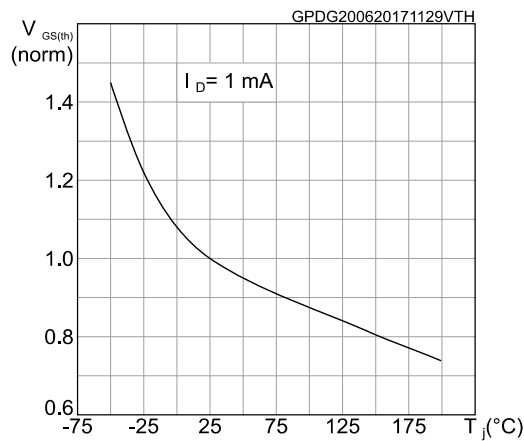

Figure 15: Normalized on-resistance vs. temperature

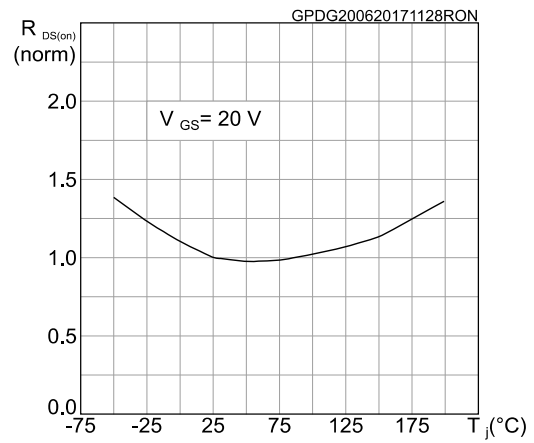

Figure 16: Body diode characteristics ( $T_J = -50 \text{ }^\circ\text{C}$ )

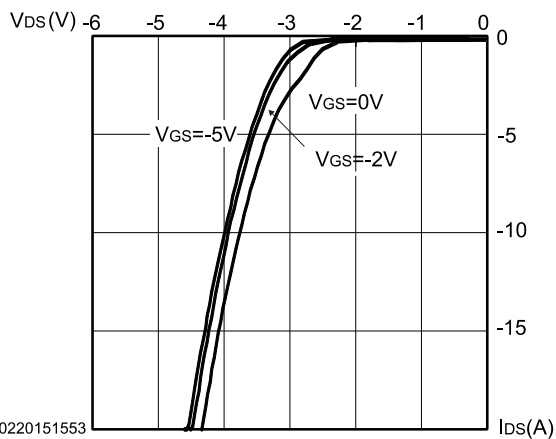

Figure 17: Body diode characteristics ( $T_J = 25 \text{ }^\circ\text{C}$ )

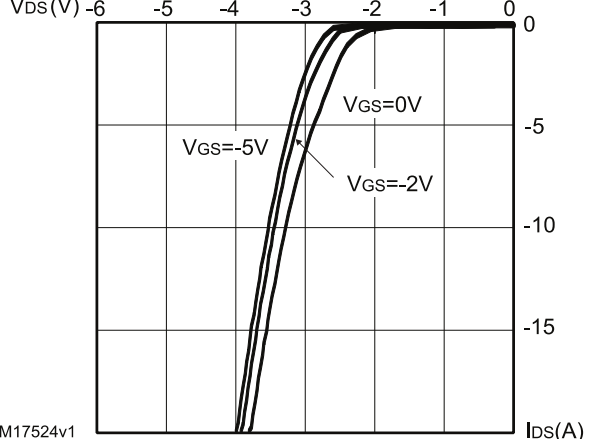

Figure 18: Body diode characteristics ( $T_J = 150 \text{ }^\circ\text{C}$ )

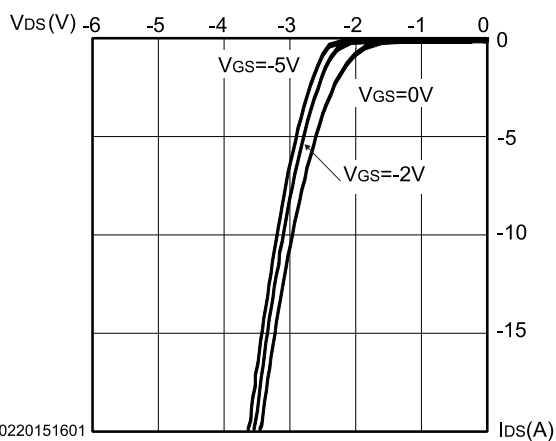

Figure 19: 3rd quadrant characteristics ( $T_J = -50 \text{ }^\circ\text{C}$ )

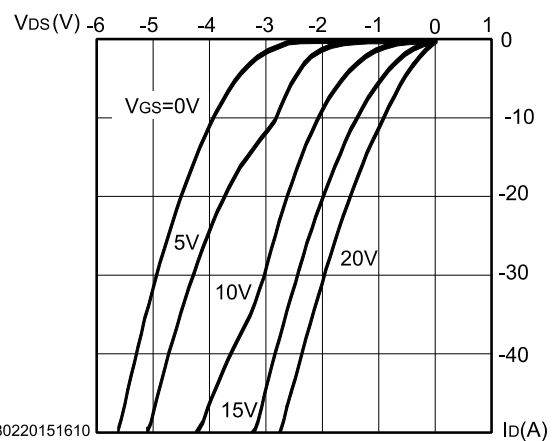



Figure 20: 3rd quadrant characteristics ( $T_J = 25\text{ }^\circ\text{C}$ )

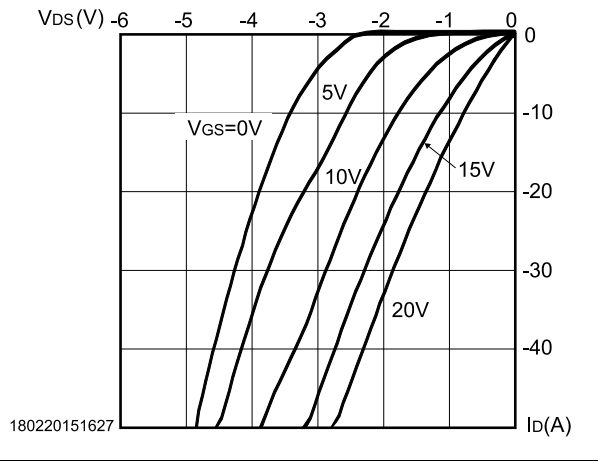
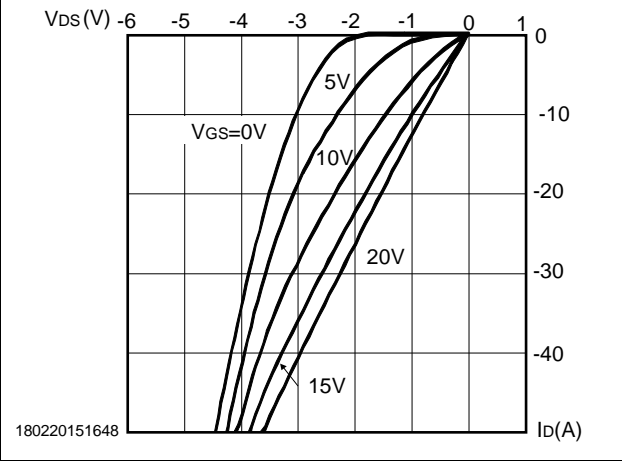

Figure 21: 3rd quadrant characteristics ( $T_J = 150\text{ }^\circ\text{C}$ )



### 3 Package information

In order to meet environmental requirements, ST offers these devices in different grades of ECOPACK® packages, depending on their level of environmental compliance. ECOPACK® specifications, grade definitions and product status are available at: [www.st.com](http://www.st.com). ECOPACK® is an ST trademark.

#### 3.1 HiP247 long leads package information

Figure 22: HiP247™ long leads package outline

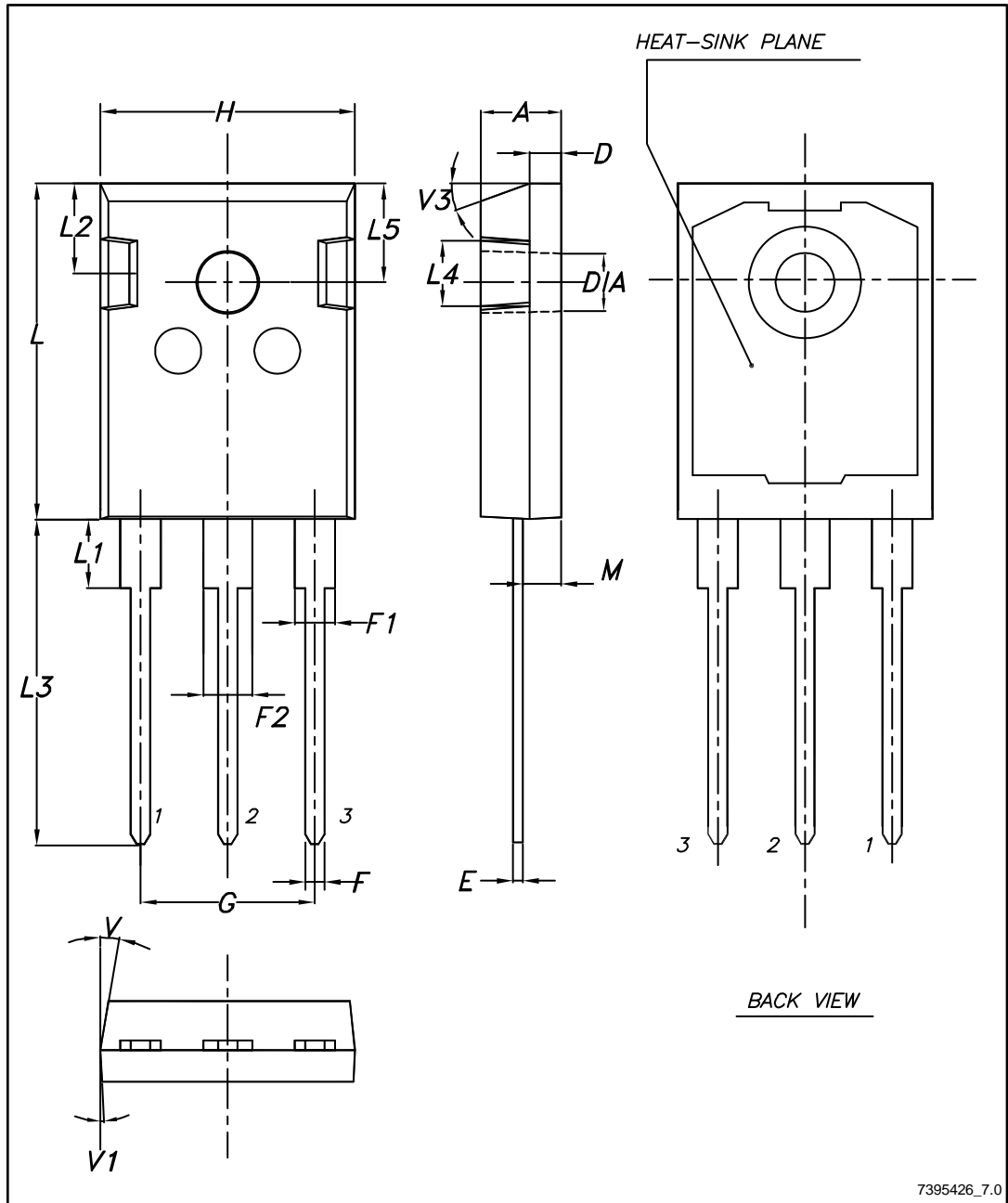

Table 9: HiP247™ long leads package mechanical data

Dim.	mm		
	Min.	Typ.	Max.
A	4.90		5.15
D	1.85		2.10
E	0.55		0.67
F	1.07		1.32
F1	1.90		2.38
F2	2.87		3.38
G	10.90 BSC		
H	15.77		16.02
L	20.82		21.07
L1	4.16		4.47
L2	5.49		5.74
L3	20.05		20.30
L4	3.68		3.93
L5	6.04		6.29
M	2.25		2.55
V		10°	
V1		3°	
V3		20°	
DIA	3.55		3.66

## 4 Revision history

**Table 10: Document revision history**

Date	Revision	Changes
11-Jan-2016	1	First release.
19-Jun-2017	2	Updated title, features in cover page. Minor text edit in <i>Section 1: "Electrical ratings"</i> and <i>Section 2: "Electrical characteristics"</i> . Updated <i>Figure 2: "Safe operating area"</i> , <i>Figure 3: "Thermal impedance"</i> , <i>Figure 13: "Normalized V(BR)DSS vs. temperature"</i> , <i>Figure 14: "Normalized gate threshold voltage vs. temperature"</i> and <i>Figure 15: "Normalized on-resistance vs. temperature"</i> . Document status promoted from preliminary to production data.

**IMPORTANT NOTICE – PLEASE READ CAREFULLY**

STMicroelectronics NV and its subsidiaries ("ST") reserve the right to make changes, corrections, enhancements, modifications, and improvements to ST products and/or to this document at any time without notice. Purchasers should obtain the latest relevant information on ST products before placing orders. ST products are sold pursuant to ST's terms and conditions of sale in place at the time of order acknowledgement.

Purchasers are solely responsible for the choice, selection, and use of ST products and ST assumes no liability for application assistance or the design of Purchasers' products.

No license, express or implied, to any intellectual property right is granted by ST herein.

Resale of ST products with provisions different from the information set forth herein shall void any warranty granted by ST for such product.

ST and the ST logo are trademarks of ST. All other product or service names are the property of their respective owners.

Information in this document supersedes and replaces information previously supplied in any prior versions of this document.

© 2017 STMicroelectronics – All rights reserved



Компания «ЭлектроПласт» предлагает заключение долгосрочных отношений при поставках импортных электронных компонентов на взаимовыгодных условиях!

Наши преимущества:

- Оперативные поставки широкого спектра электронных компонентов отечественного и импортного производства напрямую от производителей и с крупнейших мировых складов;
- Поставка более 17-ти миллионов наименований электронных компонентов;
- Поставка сложных, дефицитных, либо снятых с производства позиций;
- Оперативные сроки поставки под заказ (от 5 рабочих дней);
- Экспресс доставка в любую точку России;
- Техническая поддержка проекта, помощь в подборе аналогов, поставка прототипов;
- Система менеджмента качества сертифицирована по Международному стандарту ISO 9001;
- Лицензия ФСБ на осуществление работ с использованием сведений, составляющих государственную тайну;
- Поставка специализированных компонентов (Xilinx, Altera, Analog Devices, Intersil, Interpoint, Microsemi, Aeroflex, Peregrine, Syfer, Eurofarad, Texas Instrument, Miteq, Cobham, E2V, MA-COM, Hittite, Mini-Circuits, General Dynamics и др.);

Помимо этого, одним из направлений компании «ЭлектроПласт» является направление «Источники питания». Мы предлагаем Вам помощь Конструкторского отдела:

- Подбор оптимального решения, техническое обоснование при выборе компонента;
- Подбор аналогов;
- Консультации по применению компонента;
- Поставка образцов и прототипов;
- Техническая поддержка проекта;
- Защита от снятия компонента с производства.



#### Как с нами связаться

**Телефон:** 8 (812) 309 58 32 (многоканальный)

**Факс:** 8 (812) 320-02-42

**Электронная почта:** [org@eplast1.ru](mailto:org@eplast1.ru)

**Адрес:** 198099, г. Санкт-Петербург, ул. Калинина, дом 2, корпус 4, литера А.