

## TWO STAGE POWER AMPLIFIER MODULE, 10 MHz - 6 GHz

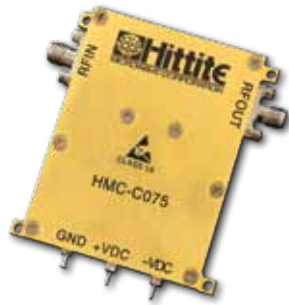

### Typical Applications

The HMC-C075 is ideal for:

- Telecom Infrastructure
- Test Instrumentation
- Military & Space

### Functional Diagram

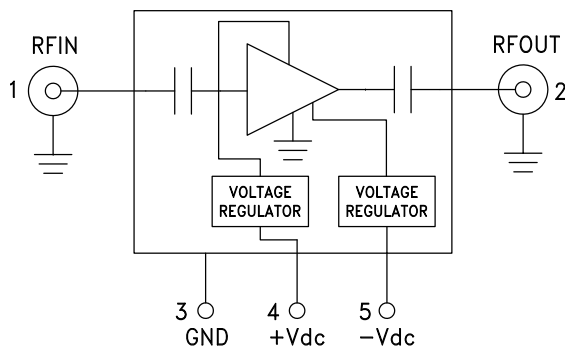

### Features

- Gain: 24 dB
- High P1dB Output Power: +29.5 dBm
- High Output IP3: +42 dBm
- Excellent Gain Flatness:  $\pm 0.75$  dB
- Regulated Supply and Bias Sequencing
- Field Replaceable SMA Connectors
- Operating Temperature:  $-40^{\circ}\text{C}$  to  $+70^{\circ}\text{C}$

### General Description

The HMC-C075 is a Two Stage Power Amplifier module which operates between 10 MHz and 6 GHz. The amplifier provides 24 dB of gain, +42 dBm output IP3 and +29 dBm of output power at 1 dB gain compression while consuming only 740 mA from a +15V supply. Gain flatness is excellent at  $\pm 0.75$  dB from 10 MHz - 6 GHz making the HMC-C075 ideal for EW, ECM, Radar and test equipment applications. The amplifier I/Os are internally matched to 50 Ohms and are DC blocked. Integrated voltage regulators allow for flexible biasing of both the negative and positive supply pins, while internal bias sequencing circuitry allows robust operation.

### Electrical Specifications, $T_A = +25^{\circ}\text{C}$ , $-V_{dc} = -5\text{V}$ , $+V_{dc} = +15\text{V}$

Parameter	Min.	Typ.	Max.	Units
Frequency Range	0.01 - 6			GHz
Gain	21	24		dB
Gain Flatness		+0.75		dB
Gain Variation Over Temperature		0.044		dB/ $^{\circ}\text{C}$
Input Return Loss		15		dB
Output Return Loss		18		dB
Output Power for 1 dB Compression (P1dB)	27.5	29.5		dBm
Saturated Output Power (P <sub>sat</sub> )		30		dBm
Output Third Order Intercept (IP3)		42		dBm
Noise Figure		5		dB
Supply Current (+15V)		740	800	mA
Supply Current (-5V)		5		mA

## TWO STAGE POWER AMPLIFIER MODULE, 10 MHz - 6 GHz

**Gain & Return Loss**

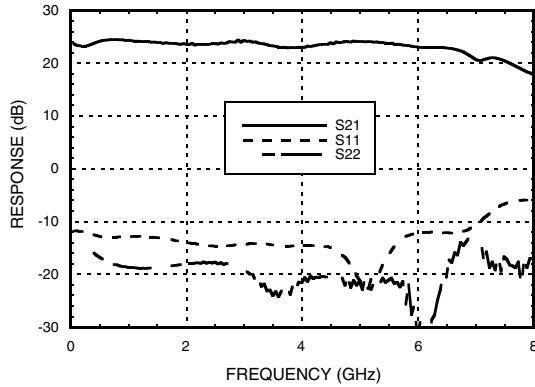

**Gain vs. Temperature**

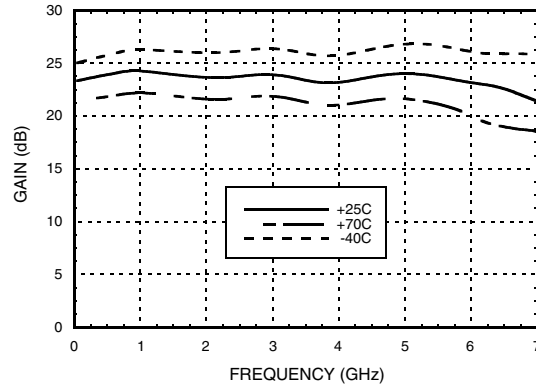

**Input Return Loss vs. Temperature**

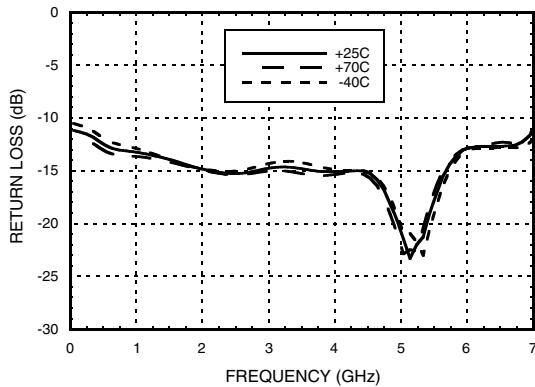

**Output Return Loss vs. Temperature**

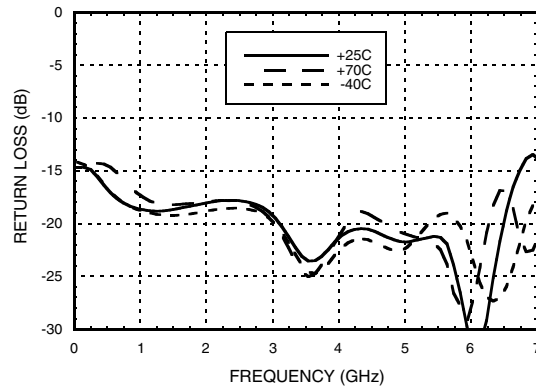

**Reverse Isolation vs. Temperature**

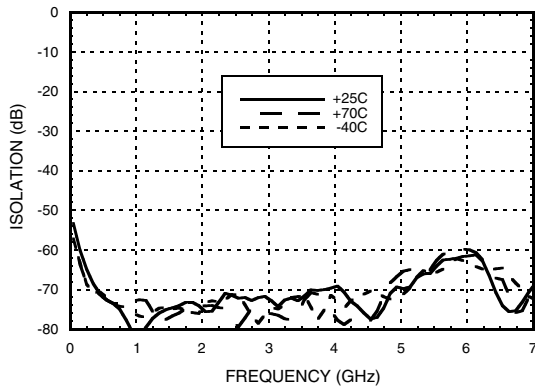

**Noise Figure vs. Temperature**

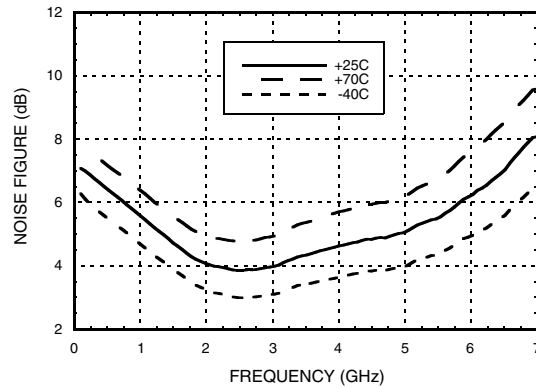

## TWO STAGE POWER AMPLIFIER MODULE, 10 MHz - 6 GHz

**Output P1dB vs. Temperature**

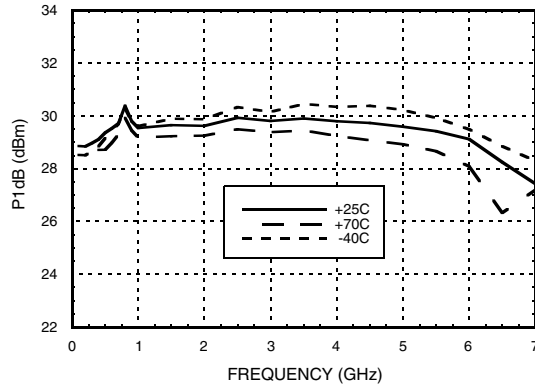

**Output Psat vs. Temperature**

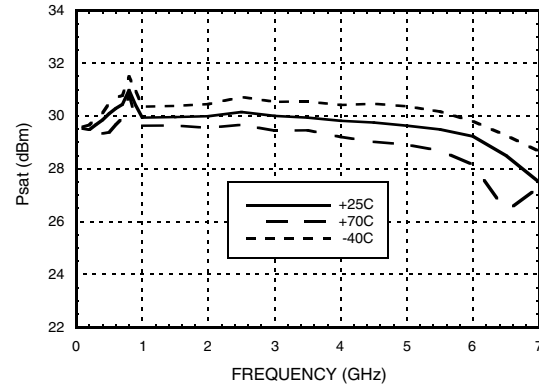

**Output IP3 vs. Temperature**

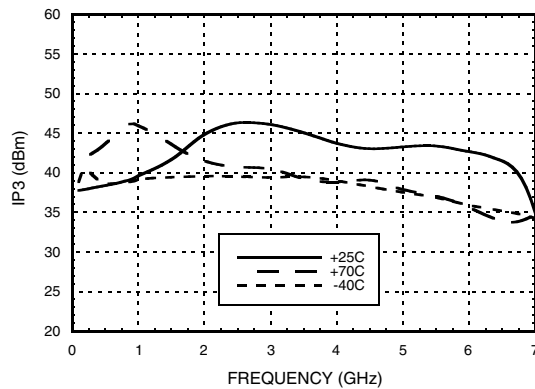

**Power Compression @ 3 GHz**

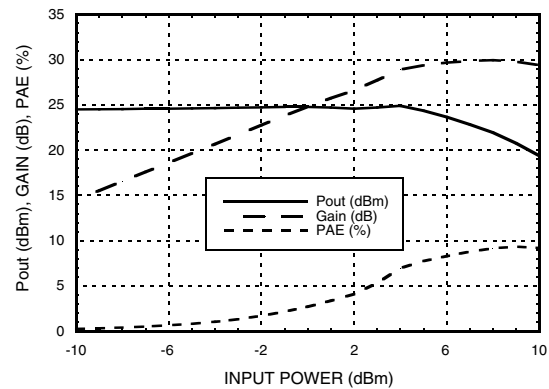

**Gain & Return Loss vs. Frequency  
Log Scale**

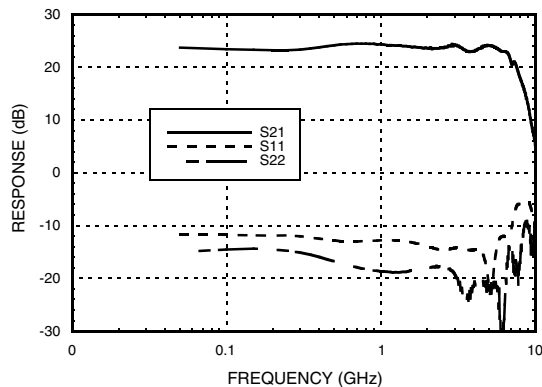

**Output IP3 vs. Temperature  
Log Scale**

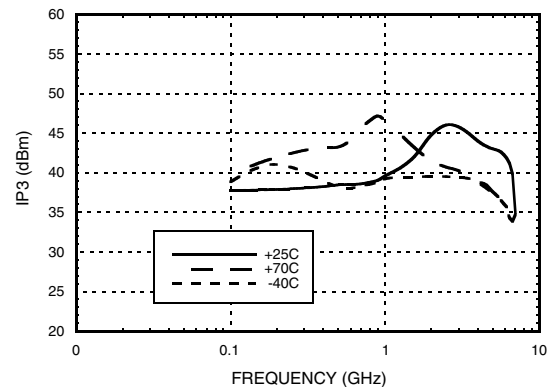



## TWO STAGE POWER AMPLIFIER MODULE, 10 MHz - 6 GHz



### Absolute Maximum Ratings

Positive Bias Supply Voltage (+Vdc)	+16V Max
Negative Bias Supply (-Vdc)	-16V Min.
RF Input Power (RFIN)	12 dBm
Thermal Resistance	5.9 °C/W
Storage Temperature	-55 to +150 °C
Operating Temperature	-40 to +70 °C

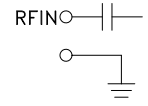
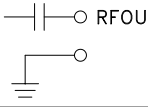

ELECTROSTATIC SENSITIVE DEVICE  
OBSERVE HANDLING PRECAUTIONS

### Pin Descriptions

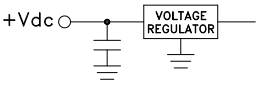
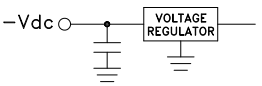
Pin Number	Function	Description	Interface Schematic
1	RFIN & RF Ground	RF input connector, SMA female, field replaceable. This pin is AC coupled and matched to 50 Ohms.	
2	RFOUT & RF Ground	RF output connector, SMA female. This pin is AC coupled and matched to 50 Ohms.	
3	GND	Power supply ground.	
4	+Vdc	Positive power supply voltage for the amplifier. (+14V to +16V)	
5	-Vdc	Negative power supply voltage for the amplifier. (-5V to -16V)	

## TWO STAGE POWER AMPLIFIER MODULE, 10 MHz - 6 GHz



### Outline Drawing

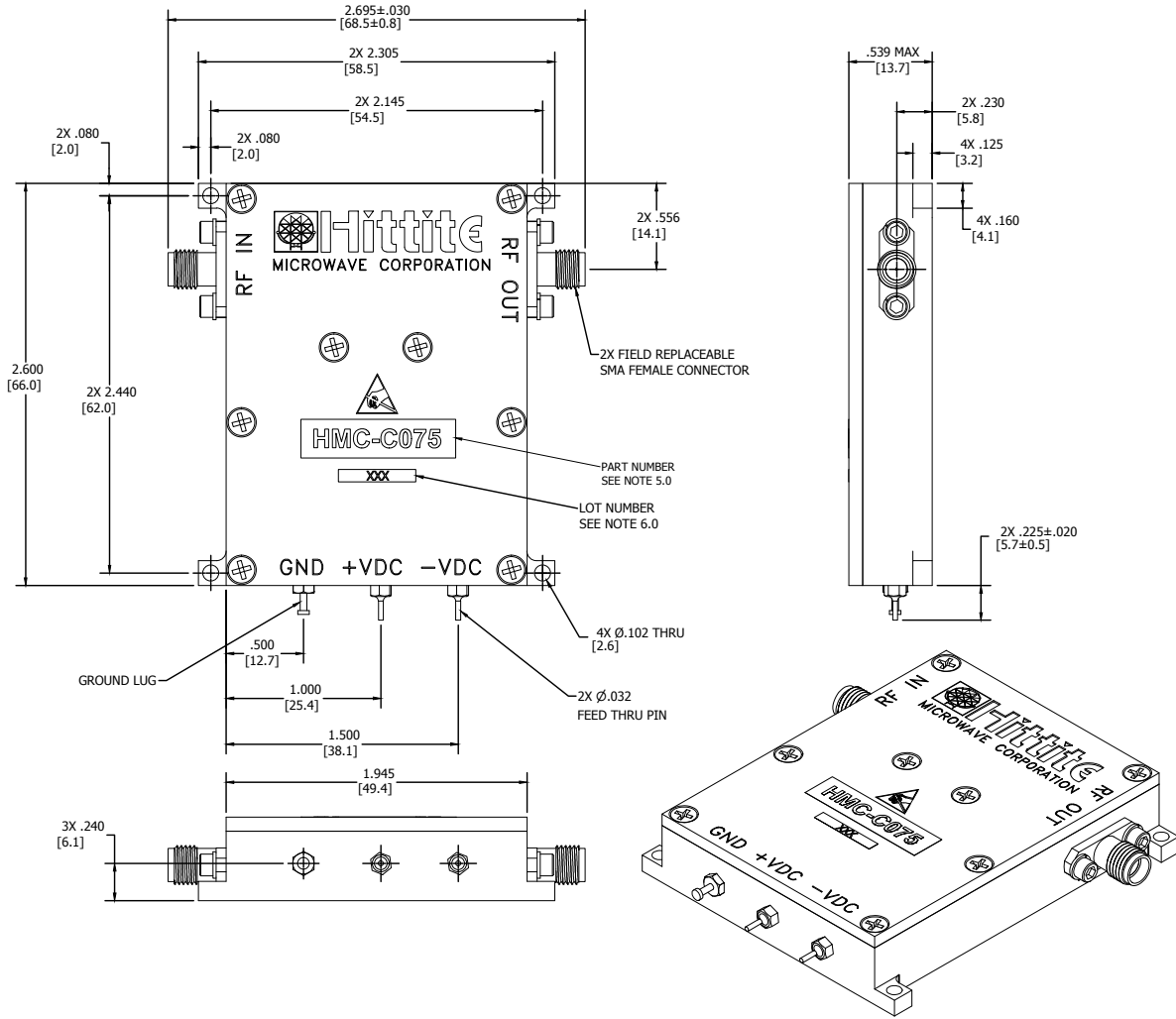

### Package Information

Package Type	C-17
--------------	------

**NOTES:**

1. PACKAGE, COVER MATERIAL: ALUMINUM
2. FINISH: GOLD PLATE OVER NICKEL PLATE.
3. ALL DIMENSIONS ARE IN INCHES [MILLIMETERS].
4. TOLERANCES:
  - 4.1 .XX = ±.02
  - 4.2 .XXX = ±.010
5. MARK PART NO. ON .250 X 1.000 LABEL WHERE SHOWN, WITH .100 MIN. TEXT HEIGHT.
6. MARK LOT NUMBER ON .080 X .250 LABEL WHERE SHOWN, WITH .030 MIN. TEXT HEIGHT.



MICROWAVE CORPORATION v02.0711



**HMC-C075**

**TWO STAGE POWER AMPLIFIER  
MODULE, 10 MHz - 6 GHz**

**Notes:**

1

AMPLIFIERS



Компания «ЭлектроПласт» предлагает заключение долгосрочных отношений при поставках импортных электронных компонентов на взаимовыгодных условиях!

Наши преимущества:

- Оперативные поставки широкого спектра электронных компонентов отечественного и импортного производства напрямую от производителей и с крупнейших мировых складов;
- Поставка более 17-ти миллионов наименований электронных компонентов;
- Поставка сложных, дефицитных, либо снятых с производства позиций;
- Оперативные сроки поставки под заказ (от 5 рабочих дней);
- Экспресс доставка в любую точку России;
- Техническая поддержка проекта, помощь в подборе аналогов, поставка прототипов;
- Система менеджмента качества сертифицирована по Международному стандарту ISO 9001;
- Лицензия ФСБ на осуществление работ с использованием сведений, составляющих государственную тайну;
- Поставка специализированных компонентов (Xilinx, Altera, Analog Devices, Intersil, Interpoint, Microsemi, Aeroflex, Peregrine, Syfer, Eurofarad, Texas Instrument, Miteq, Cobham, E2V, MA-COM, Hittite, Mini-Circuits, General Dynamics и др.);

Помимо этого, одним из направлений компании «ЭлектроПласт» является направление «Источники питания». Мы предлагаем Вам помощь Конструкторского отдела:

- Подбор оптимального решения, техническое обоснование при выборе компонента;
- Подбор аналогов;
- Консультации по применению компонента;
- Поставка образцов и прототипов;
- Техническая поддержка проекта;
- Защита от снятия компонента с производства.



#### Как с нами связаться

**Телефон:** 8 (812) 309 58 32 (многоканальный)

**Факс:** 8 (812) 320-02-42

**Электронная почта:** [org@eplast1.ru](mailto:org@eplast1.ru)

**Адрес:** 198099, г. Санкт-Петербург, ул. Калинина, дом 2, корпус 4, литера А.