

BMD-330 Module for Bluetooth 5 LE

The **BMD-330** from Rigado is a powerful, highly flexible, ultra-low power **Bluetooth 5** module based on the nRF52810 SoC from Nordic Semiconductor. With an ARM® Cortex™ M4 CPU, embedded 2.4GHz transceiver, and integrated antenna, it provides a complete RF solution with no additional RF design, allowing faster time to market. Providing full use of the nRF52810's capabilities and peripherals, the **BMD-330** can power demanding applications, while simplifying designs and reducing BOM costs. With an internal DC-DC converter and intelligent power control, the **BMD-330** provides class-leading power efficiency, enabling ultra-low power sensitive applications. Regulatory pre-approvals reduce the burden to enter the market. As a drop in replacement for the BMD-300/301, the **BMD-330** completes Rigado's BMD-300 Series lineup with an optimized peripheral set that is attractive for a wide range of cost-sensitive applications.



1. Features

- Based on the Nordic nRF52810 SoC
- Complete RF solution with integrated antenna
- Integrated DC-DC converter
- No external components required
- ARM® Cortex™-M4 32-bit processor
- Serial Wire Debug (SWD)
- Nordic SoftDevice ready
- Over-the-Air (OTA) firmware updates
- 192kB embedded flash memory
- 24kB RAM
- 32 General Purpose I/O Pins
- 12-bit/200KSPS ADC
- -40C to +85C Temperature Range
- FCC: **2AA9B09**
- SPI Master/Slave (8 Mbps)
- General purpose comparator
- Temperature sensor
- Random Number Generator
- 2-wire serial Master/Slave (I2C compatible)
- UART (w/ CTS/RTS and DMA)
- 20 channel CPU independent Programmable Peripheral Interconnect (PPI)
- Quadrature Demodulator (QDEC)
- 128-bit AES HW encryption
- 3 x 32bit, 2 x 24bit Real Timer Counters (RTC)
- Dimensions: 14 x 9.8 x 1.9mm
- IC: **12208A-09**

2. Applications

- Climate Control
- Lighting Products
- Safety and Security
- Home Appliances
- Access Control
- Internet of Things (IoT)
- Home Health care
- Advanced Remote Controls
- Smart Energy Management
- Low-Power Sensors
- Beacons– iBeacon™, AltBeacon, Eddystone, etc.
- Environmental Monitoring
- Hotel Automation
- Office Automation
- Wearables



3. Ordering Information

Email modules@rigado.com for quotes and ordering or visit <http://www.rigado.com/BMD-330>

Part Number	Description
BMD-330-A-R	BMD-330 module, Rev A, Tape & Reel, 1000 piece multiples
BMD-330-EVAL	BMD-330 Evaluation Kit with Segger J-Link programmer

Table 1 – Ordering Part Numbers

4. Block Diagram

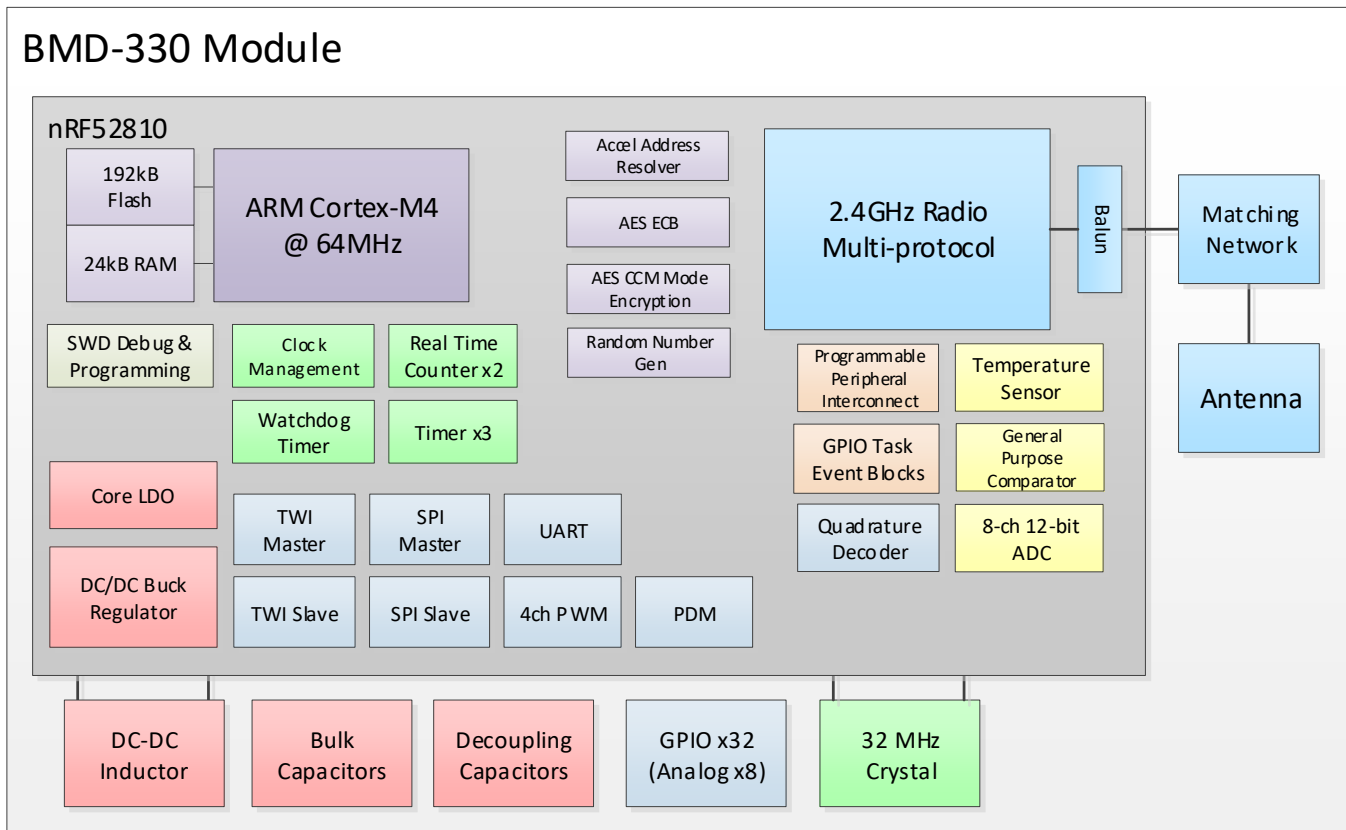

Figure 1 – Block Diagram

Table of Contents

1.	FEATURES.....	1
2.	APPLICATIONS.....	1
3.	ORDERING INFORMATION.....	2
4.	BLOCK DIAGRAM.....	2
5.	QUICK SPECIFICATIONS	4
6.	PIN DESCRIPTIONS	5
7.	ELECTRICAL SPECIFICATIONS	7
7.1	ABSOLUTE MAXIMUM RATINGS.....	7
7.2	OPERATING CONDITIONS	7
7.3	GENERAL PURPOSE I/O	7
7.4	MODULE RESET	8
7.5	DEBUG & PROGRAMMING	8
7.6	CLOCKS.....	8
8.	FIRMWARE.....	9
8.1	FACTORY IMAGE	9
8.2	SOFTDEVICES	9
8.2.1	S132	9
8.3	MAC ADDRESS INFO	9
9.	MECHANICAL DATA.....	12
9.1	MECHANICAL DIMENSIONS.....	12
9.2	RECOMMENDED PCB LAND PADS.....	13
10.	MODULE MARKING	13
11.	RF DESIGN NOTES.....	14
11.1	RECOMMENDED RF LAYOUT & GROUND PLANE	14
11.2	MECHANICAL ENCLOSURE	14
11.3	ANTENNA PATTERNS	15
12.	EVALUATION BOARDS.....	17
13.	SOLUTION SERVICES.....	17
14.	BLUETOOTH QUALIFICATION.....	18
15.	REGULATORY STATEMENTS.....	18
15.1	FCC STATEMENT:	18
15.2	FCC IMPORTANT NOTES.....	18
15.3	IC STATEMENT:	20
15.4	IC IMPORTANT NOTES.....	20
15.5	CE REGULATORY.....	21
15.6	AUSTRALIA / NEW ZEALAND	21
16.	SOLDER REFLOW TEMPERATURE-TIME PROFILE	22
16.1	MOISTURE SENSITIVITY LEVEL	22
17.	PACKAGING AND LABELING.....	22
17.1	CARRIER TAPE DIMENSIONS.....	22
17.2	REEL PACKAGING	23
17.3	PACKAGING LABEL.....	23
18.	CAUTIONS	24
19.	LIFE SUPPORT POLICY.....	24
20.	DOCUMENT HISTORY	25
21.	RELATED DOCUMENTS	25

5. Quick Specifications

Bluetooth		
Version	5.0 (<i>Bluetooth Smart</i>) Concurrent Central & Peripheral (S132)	
Security	AES-128	
LE connections	Concurrent central, observer, peripheral, and broadcaster roles with multiple concurrent connections along with one Observer and one Broadcaster (S132)	
Radio		
Frequency	2.360GHz to 2.500GHz	
Modulations	GFSK at 1 Mbps, 2 Mbps data rates	
Transmit power	+4 dBm	
Receiver sensitivity	-96 dBm (BLE mode)	
Antenna	Integrated	
Current Consumption		
TX only @ +4 dBm, 0 dBm @ 3V, DCDC enabled	7.0 mA, 4.6 mA	
TX only @ +4 dBm, 0 dBm	15.4 mA, 10.1 mA	
RX only @ 1 Mbps @ 3V, DCDC enabled	4.6 mA	
RX only @ 1 Mbps	10.0 mA	
RX only @ 2 Mbps @ 3V, DCDC enabled	5.8 mA	
RX only @ 2 Mbps	11.2 mA	
CPU @ 64MHz from flash, from RAM	4.0 mA, 3.8 mA	
CPU @ 64MHz from flash, from RAM @ 3V, DCDC	2.4 mA, 2.1 mA	
System Off, On	0.3 μ A, 0.6 μ A	
Additional current for RAM retention	30 nA / 4KB block	
Dimensions		
BMD-330	Length	14.0 mm \pm 0.3mm
	Width	9.8 mm \pm 0.3mm
	Height	1.9 mm \pm 0.1mm
Hardware		
Interfaces	SPI Master/Slave	I2S
	UART	PWM
	Two-Wire Master/Slave (I2C)	PDM
	GPIO x 32	ADC
Power supply	1.7V to 3.6V	
Temperature Range	-40C to +85°C	
Certifications		
FCC	FCC part 15 modular certification FCC ID: 2AA9B09	
IC	Industry Canada RSS-210 modular certification IC: 12208A-09	
CE	EN 60950-1: A2:2013	3.1 (a): Health and Safety of the User
	EN 301 489-1 V2.1.1 & EN 301 489-17 V3.1.1	3.1 (b): Electromagnetic Compatibility
	EN 300 328 V2.1.1	3.2: Effective use of spectrum allocated
Australia / New Zealand	AS/NZS 4268 :2012+AMDT 1:2013, Radio equipment and systems – Short range devices	
Bluetooth	BT5 RF-PHY Component (Tested) – DID: D037298; QDID 101625	
	BT4.2 RF-PHY Component (Tested) – DID: D030629; QDID 81876	
Export		
ECCN	5A992.C, Exception 742.15(b)(1)	
HTS	8473.30.1180	

Table 2 – Quick Specifications

6. Pin Descriptions

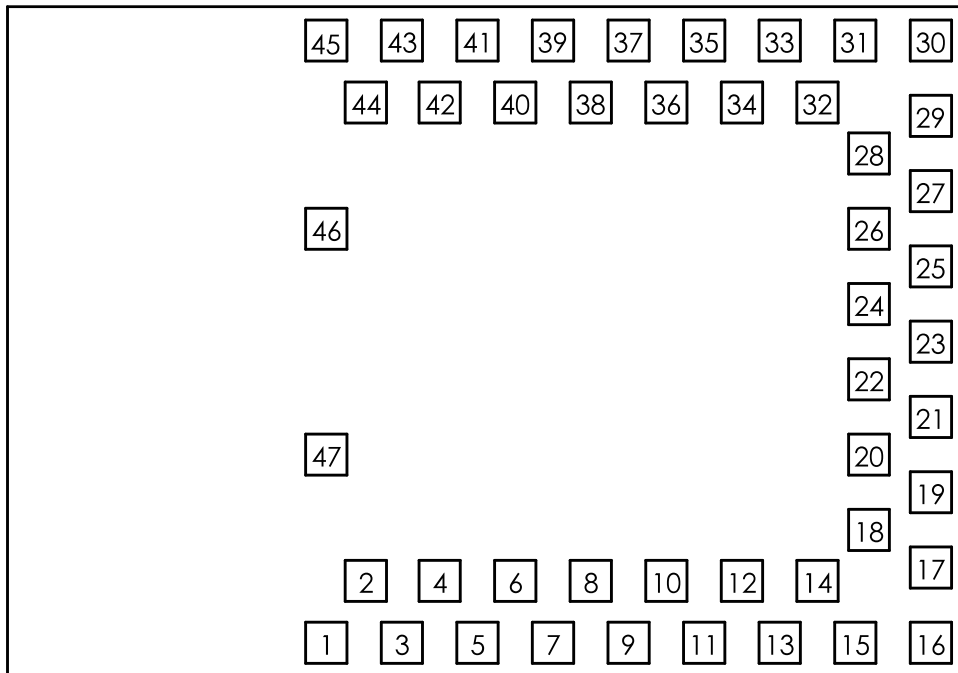

Figure 2 – BMD-330 Pin out (Top View)

Pin description

Pin	Name	Direction	Description
6	P0.25	In/Out	GPIO ²
7	P0.26	In/Out	GPIO ²
8	P0.27	In/Out	GPIO ²
9	P0.28	In/Out	GPIO/AIN4 ²
10	P0.29	In/Out	GPIO/AIN5 ²
11	P0.30	In/Out	GPIO/AIN6 ²
12	P0.31	In/Out	GPIO/AIN7 ²
13	P0.00	In/Out	GPIO/XTAL1 (32.768kHz)
14	P0.01	In/Out	GPIO/XTAL2 (32.768kHz)
15	P0.02	In/Out	GPIO/AIN0
19	P0.03	In/Out	GPIO/AIN1
20	P0.04	In/Out	GPIO/AIN2
21	P0.05	In/Out	GPIO/AIN3
22	P0.06	In/Out	GPIO
23	P0.07	In/Out	GPIO
24	P0.08	In/Out	GPIO
25	P0.09	In/Out	GPIO
26	P0.10	In/Out	GPIO
27	P0.11	In/Out	GPIO
28	P0.12	In/Out	GPIO
31	P0.13	In/Out	GPIO

Pin	Name	Direction	Description
32	P0.14	In/Out	GPIO
33	P0.15	In/Out	GPIO
34	P0.16	In/Out	GPIO
35	P0.17	In/Out	GPIO
36	P0.18	In/Out	GPIO
37	P0.19	In/Out	GPIO
38	P0.20	In/Out	GPIO
39	P0.21	In/Out	GPIO/ $\overline{\text{RESET}}$
40	P0.22	In/Out	GPIO ²
41	P0.23	In/Out	GPIO ²
42	P0.24	In/Out	GPIO ²
43	SWCLK	In	SWD Clock
44	SWDIO	In/Out	SWD IO
17	VCC	Power	+1.7V to +3.6V ¹
1, 2, 3, 4, 5, 16, 18, 29, 30, 45, 46, 47	GND	Power	Electrical Ground

Note 1: An internal 4.7 μ F bulk capacitor is included on the module. However, it is good design practice to add additional bulk capacitance as required for your application, i.e. those with heavy GPIO usage and/or current draw.

Note 2: These pins are in close proximity to the nRF52 radio power supply and antenna pins. Radio performance parameters, such as sensitivity, may be affected by high frequency digital I/O with large sink/source current on these pins. Nordic recommends using only low frequency, low-drive functions when possible.

Table 3 – BMD-330 Pin Descriptions

7. Electrical Specifications

7.1 Absolute Maximum Ratings

Symbol	Parameter	Min.	Max.	Unit
V_{CC_MAX}	Voltage on supply pin	-0.3	3.9	V
V_{IO_MAX}	Voltage on GPIO pins ($V_{CC} > 3.6V$)	-0.3	3.9	V
V_{IO_MAX}	Voltage on GPIO pins ($V_{CC} \leq 3.6V$)	-0.3	$V_{CC} + 0.3V$	V
T_S	Storage Temperature Range	-40	125	°C

Table 4 – Absolute Maximum Ratings

7.2 Operating Conditions

Symbol	Parameter	Min.	Typ.	Max.	Unit
V_{CC}	Operating supply voltage	1.7	3.0	3.6	V
T_{R_VCC}	Supply rise time (0V to 1.7V)	-	-	60	ms
T_A	Operating Ambient Temperature Range	-40	25	85	°C

Table 5 – Operating Conditions

7.3 General Purpose I/O

The general purpose I/O is organized as one port enabling access and control of the 32 available GPIO pins through one port. Each GPIO can be accessed individually with the following user configurable features:

- Input/output direction
- Output drive strength
- Internal pull-up and pull-down resistors
- Wake-up from high or low level triggers on all pins
- Trigger interrupt on all pins
- All pins can be used by the PPI task/event system; the maximum number of pins that can be interfaced through the PPI at the same time is limited by the number of GPIOTE channels
- All pins can be individually configured to carry serial interface or quadrature demodulator signals

Symbol	Parameter	Min.	Typ.	Max.	Unit
V_{IH}	Input High Voltage	$0.7 \times V_{CC}$	-	V_{CC}	V
V_{IL}	Input Low Voltage	V_{SS}	-	$0.3 \times V_{CC}$	V
V_{OH}	Output High Voltage	$V_{CC} - 0.4$	-	V_{CC}	V
V_{OL}	Output Low Voltage	V_{SS}	-	$V_{SS} + 0.4$	V
R_{PU}	Pull-up Resistance	11	13	16	kΩ
R_{PD}	Pull-down Resistance	11	13	16	kΩ

Table 6 – GPIO

7.4 Module RESET

GPIO pin P0.21 may be used for a hardware reset. In order to utilize P0.21 as a hardware reset, the UICR registers PSELRESET[0] and PSELRESET[1] must be set alike, to the value of 0x7FFFFFFF. When P0.21 is programmed as RESET, the internal pull-up is automatically enabled. Rigado and Nordic example applications and development kits program P0.21 as RESET.

7.5 Debug & Programming

The BMD-330 supports the two pin Serial Wire Debug (SWD) interface and offers flexible and powerful mechanism for non-intrusive debugging of program code. Breakpoints, single stepping, and instruction trace capture of code execution flow are part of this support.

7.6 Clocks

The BMD-330 requires two clocks, a high frequency clock and a low frequency clock.

The high frequency clock is provided on-module by a high-accuracy 32-MHz crystal as required by the nRF52810 for radio operation.

The low frequency clock can be provided internally by an RC oscillator or synthesized from the fast clock; or externally by a 32.768 kHz crystal. An external crystal provides the lowest power consumption and greatest accuracy. Using the internal RC oscillator with calibration provides acceptable performance for BLE applications at a reduced cost and slight increase in power consumption. Note: the ANT protocol requires the use of an external crystal.

32.768 kHz Crystal (LFXO)

Symbol	Parameter	Typ.	Max.	Unit
F _{NOM_LFXO}	Crystal frequency	32.768	-	kHz
F _{TOL_LFXO_BLE}	Frequency tolerance, BLE applications	-	±250	ppm
C _{L_LFXO}	Load Capacitance	-	12.5	pF
C _{O_LFXO}	Shunt Capacitance	-	2	pF
R _{S_LFXO}	Equivalent series resistance	-	100	kΩ
C _{pin}	Input Capacitance on XL1 & XL2 pads	4	-	pF

Table 7 – 32.768 kHz Crystal

32.768 kHz Oscillator Comparison

Symbol	Parameter	Min.	Typ.	Max.	Unit
I _{LFXO}	Current for 32.768kHz Crystal Oscillator	-	0.25	-	μA
I _{LFRC}	Current for 32.768kHz RC Oscillator	-	0.6	1	μA
I _{LFSYNT}	Current for 32.768kHz Synthesized Oscillator	-	100	-	μA
f _{TOL_LFXO_BLE}	Frequency Tolerance, 32.768kHz Crystal Oscillator (BLE Stack) ¹	-	-	±250	ppm
f _{TOL_LFXO_ANT}	Frequency Tolerance, 32.768kHz Crystal Oscillator (ANT Stack) ¹	-	-	±50	ppm

Symbol	Parameter	Min.	Typ.	Max.	Unit
f_{TOL_LFRC}	Frequency Tolerance, 32.768kHz RC Oscillator	-	-	± 2	%
$f_{TOL_CAL_LFRC}$	Frequency tolerance, 32.768kHz RC after calibration	-	-	± 250	ppm
f_{TOL_LFSYNT}	Frequency Tolerance, 32.768kHz Synthesized Oscillator	-	-	± 48	ppm

Note 1: $f_{TOL_LFXO_BLE}$ and $f_{TOL_LFXO_ANT}$ are the max allowed for BLE and ANT applications. Actual tolerance depends on the crystal used.

Table 8 – 32.768 kHz Oscillator

8. Firmware

8.1 Factory Image

Due to the BMD-330's reduced memory capacity, no factory firmware image is provided on the module. This is indicated with a factory version code of "00" printed on the module label. Since there is no bootloader on the module, firmware must be loaded on the module with the SWD interface



Factory Firmware
Version Code: XX

8.2 SoftDevices

Nordic Semiconductor protocol stacks are known as SoftDevices. SoftDevices are pre-compiled, pre-linked binary files. SoftDevices can be programmed in nRF52 series SoCs and are downloadable from the Nordic website. The BMD-330 with the nRF52810 SoC supports the S132 (BLE Central & Peripheral) SoftDevice, and the memory-optimized S112 (BLE Peripheral) SoftDevice.

8.2.1 S132

The S132 SoftDevice is a Bluetooth® low energy (BLE) Central and Peripheral protocol stack solution supporting up to 20 connections with an additional Observer and a Broadcaster role all running concurrently. The S132 SoftDevice integrates a BLE Controller and Host, and provides a full and flexible API for building Bluetooth Smart nRF52 System on Chip (SoC) solutions.

Key Features

- Bluetooth 5.0 compliant low energy single-mode protocol stack suitable for Bluetooth Smart products
 - Concurrent central, observer, peripheral, and broadcaster roles with up to twenty concurrent connections along with one Observer and one Broadcaster
 - Configurable number of connections and connection properties
 - Configurable attribute table size
 - Custom UUID support
 - Link layer supporting LE 1M PHY and LE 2M PHY
 - LL Privacy
 - LE Data Packet Length Extension
 - ATT and SM protocols
 - L2CAP with LE Credit-based Flow Control
 - LE Secure Connections pairing model
 - GATT and GAP APIs
 - GATT Client and Server
 - Configurable ATT MTU
- Complementary nRF5 SDK including Bluetooth profiles and example applications
- Master Boot Record for over-the-air device firmware update
 - SoftDevice, application, and bootloader can be updated separately
- Memory isolation between the application and the protocol stack for robustness and security
- Thread-safe supervisor-call based API
- Asynchronous, event-driven behavior
- No RTOS dependency
 - Any RTOS can be used
- No link-time dependencies
 - Standard ARM® Cortex®-M4 project configuration for application development
- Support for concurrent and non-concurrent multiprotocol operation
 - Concurrent with the Bluetooth stack using Radio Timeslot API
 - Alternate protocol stack in application space

- Support for control of external Power Amplifiers and Low Noise Amplifiers

the memory-optimized S112 (BLE Peripheral) SoftDevice.

8.2.2 S112

The S112 SoftDevice is a Bluetooth low energy peripheral protocol stack solution. It supports up to four peripheral connections with an additional broadcaster role running concurrently. The S112 SoftDevice integrates a Bluetooth low energy Controller and Host, and provides a full and flexible API for building Bluetooth low energy nRF52 System on Chip (SoC) solutions.

Key Features

- Bluetooth 5.0 compliant low energy single-mode protocol stack suitable for Bluetooth low energy products
 - Up to four peripheral connections and one broadcaster running concurrently
 - Configurable number of connections and connection properties
 - Configurable attribute table size
 - Custom UUID support
 - Link layer supporting LE 1M PHY and LE 2M PHY
 - LL Privacy
 - ATT and SM protocols
 - LE Secure Connections pairing model
 - GATT and GAP APIs
 - GATT Client and Server
 - Configurable ATT MTU
- Complementary nRF5 SDK including Bluetooth profiles and example applications
- Master Boot Record for over-the-air device firmware update
 - SoftDevice, application, and bootloader can be updated separately
- Thread-safe supervisor-call based API
- Asynchronous, event-driven behavior
- No RTOS dependency
 - Any RTOS can be used
- No link-time dependencies
- Standard ARM® Cortex®- M4 project configuration for application development
- Support for concurrent and non-concurrent multiprotocol operation
 - Concurrent with the Bluetooth stack using Radio Timeslot API
 - Alternate protocol stack in application space
- Support for control of external Power Amplifiers and Low Noise Amplifiers

8.3 MAC Address Info

The BMD-330 module comes preprogrammed with a unique MAC address from the factory. The MAC address is also printed on a 2D barcode on the top of the module.



MAC Address:
94:54:93:XX:YY:ZZ

Figure 3 – BMD-300/301 MAC Address on Label

The 6-byte BLE Radio MAC address is stored in the nRF52810 UICR at NRF_UICR_BASE+0x80 LSB first. From the factory, the MAC address can be read over SWD since read-back protection is not enabled. If performing a full-chip-erase, the MAC can then only be recovered from the 2D barcode and human-readable text.

UICR Register:

NRF_UICR + 0x80 (0x10001080): MAC_Addr [0] (0xZZ)

NRF_UICR + 0x81 (0x10001081): MAC_Addr [1] (0xYY)

NRF_UICR + 0x82 (0x10001082): MAC_Addr [2] (0xXX)

NRF_UICR + 0x83 (0x10001083): MAC_Addr [3] (0x93)

NRF_UICR + 0x84 (0x10001084): MAC_Addr [4] (0x54)

NRF_UICR + 0x85 (0x10001085): MAC_Addr [5] (0x94)

9. Mechanical Data

9.1 Mechanical Dimensions

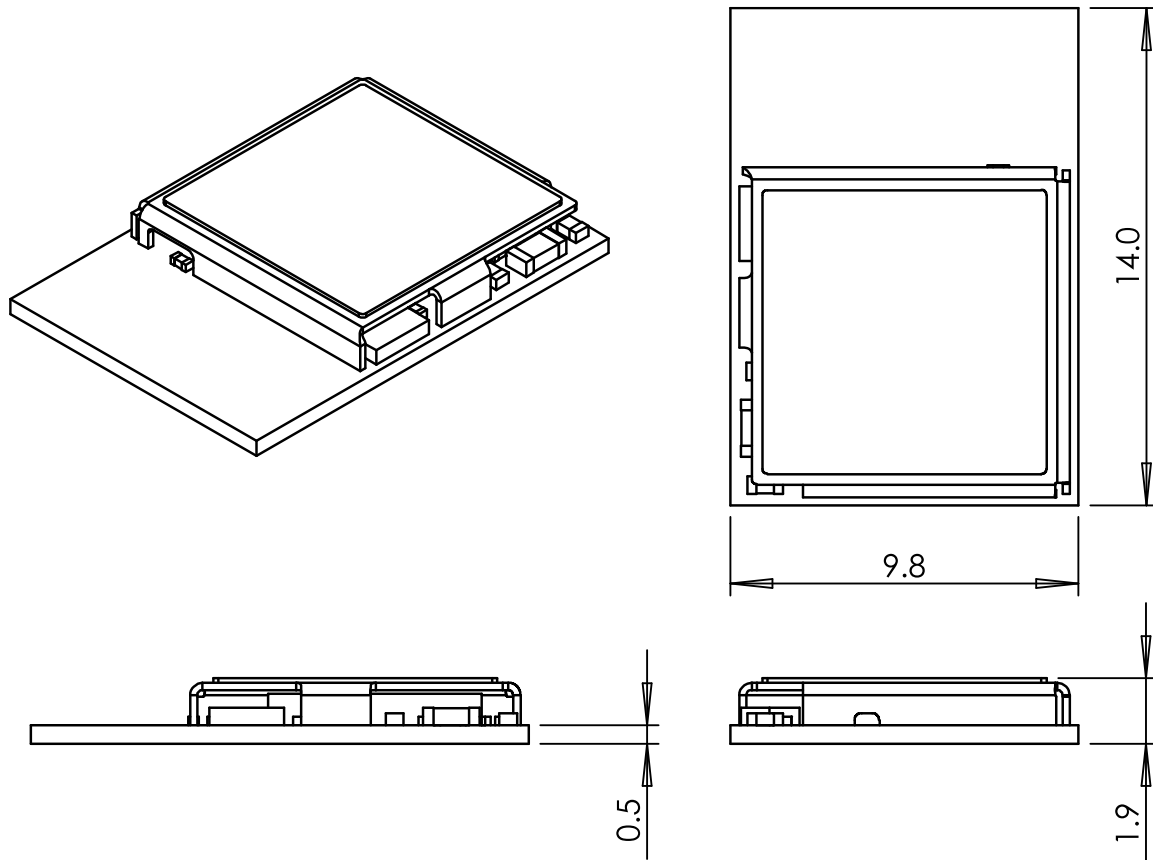

Figure 4 – BMD-330 Module Dimensions

(All dimensions are in mm)

9.2 Recommended PCB Land Pads

The BMD-330, BMD-300, and BMD-301 have identical PCB layout footprints.

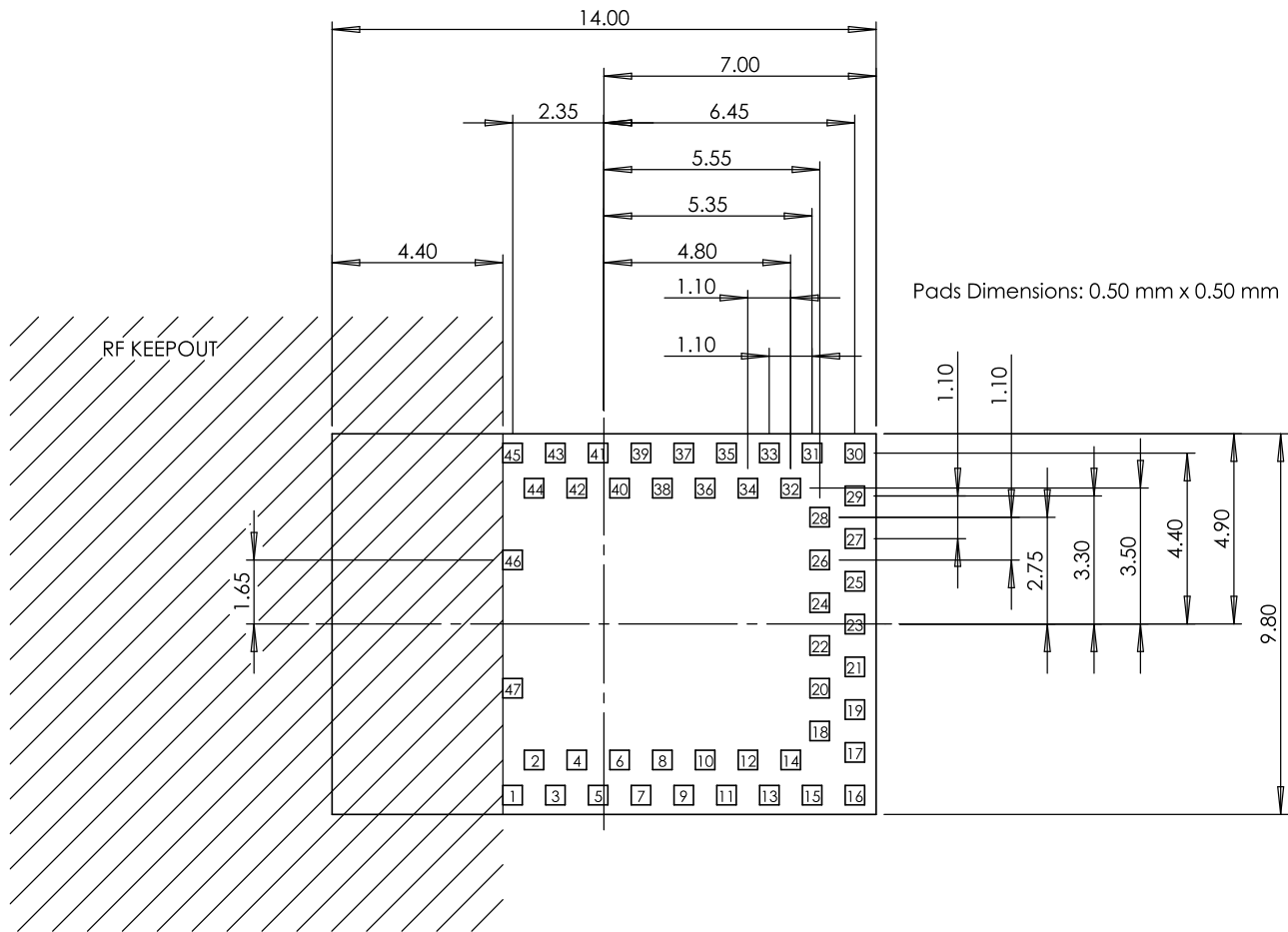

Figure 5 – BMD-300/301 Dimensions (Top View)
(All dimensions are in mm)

10. Module Marking

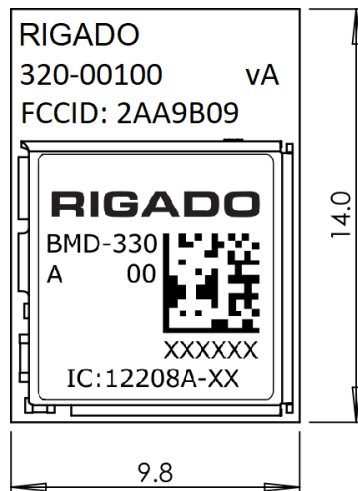

Figure 6 – BMD-330 Module Marking – Rev A

11. RF Design Notes

11.1 Recommended RF Layout & Ground Plane

For the BMD-330, the integrated antenna requires a suitable ground plane to radiate effectively. The area under and extending out from the antenna portion of the module should be kept clear of copper and other metal. The module should be placed at the edge of the PCB with the antenna edge facing out. Reducing the ground plane from that shown in Figure 7 will reduce the effective radiated power. For example, a 27mm x 29mm board (about the size of a coin cell) has approximately 3dB lower output than the BMD-330 Evaluation Board.

These RF guidelines for the BMD-330 are the same as the BMD-300 module. Designs incorporating the BMD-300 will have similar RF performance with the BMD-330 module.

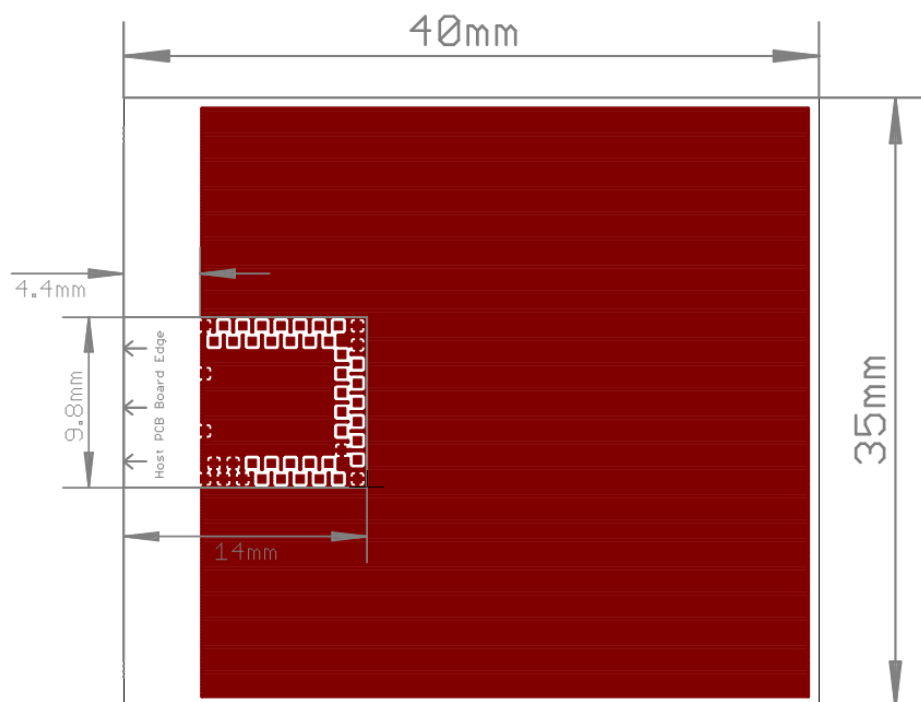

Figure 7 – BMD-300 Recommended RF Layout

11.2 Mechanical Enclosure

Care should be taken when designing and placing the module into an enclosure. Metal should be kept clear from the antenna area, both above and below. Any metal around the module can negatively impact RF performance.

The module is designed and tuned for the antenna and RF components to be in free air. Any potting, epoxy fill, plastic over-molding, or conformal coating can negatively impact RF performance and must be evaluated by the customer.

11.3 Antenna Patterns

Antenna patterns are based on the BMD-300 Evaluation Kit vA with a ground plane size of 82mm x 56mm. The BMD-300 module was replaced with a BMD-330 module. X-Y-Z orientation is shown in Figure 8:

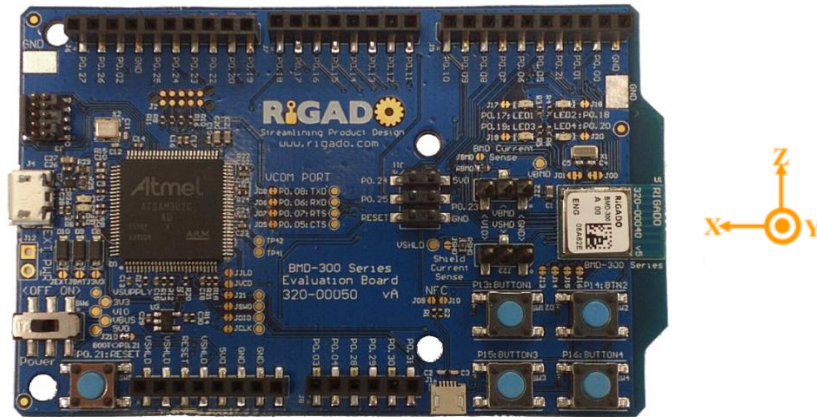

Figure 8 – X-Y-Z Antenna Orientation

11.3.1.1 X-Y Plane

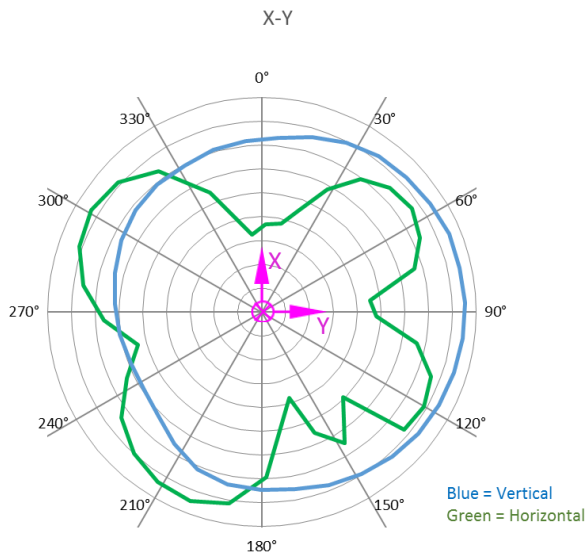
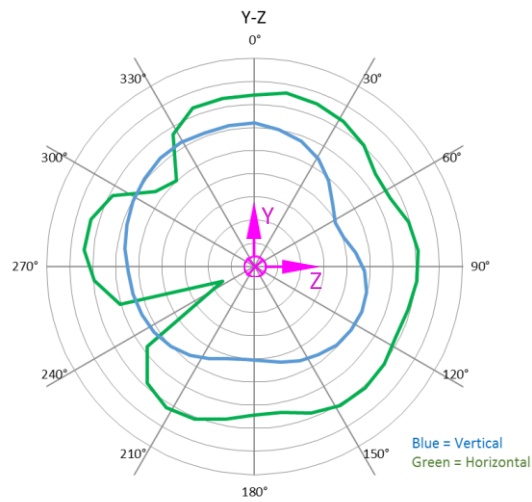
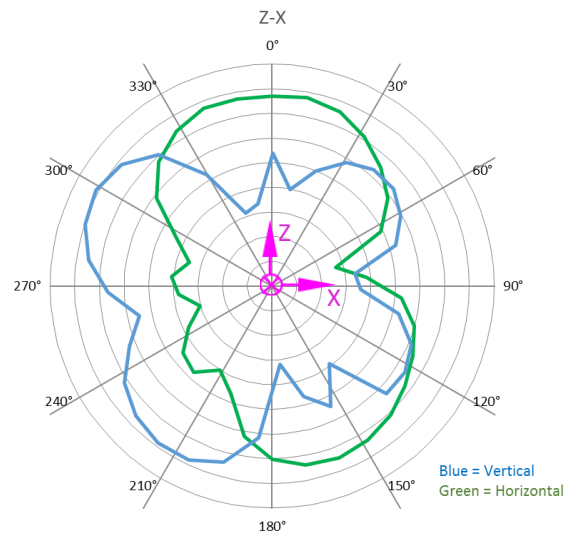

Figure 9 – X-Y Plane Antenna Pattern

11.3.1.2 Y-Z Plane

Figure 10 – Y-Z Plane Antenna Pattern
11.3.1.3 Z-X Plane

Figure 11 – Z-X Plane Antenna Pattern

12. Evaluation Boards

Rigado has developed full featured evaluation boards for the BMD-300 which can be used for BMD-330 development. The BMD-300 evaluation board provides a complete I/O pin out to headers, on-board programming and debug, 32.768 kHz crystal, power & virtual COM port over USB, 4 user LEDs, and 4 user buttons. The evaluation boards also provide the option to be powered from a CR2032 coin cell battery, and have current sense resistors and headers to allow for convenient current measurements. An Arduino Uno R3 style header is provided for easy prototyping of additional functions. The evaluation boards also support programming off-board BMD-300 Series modules.

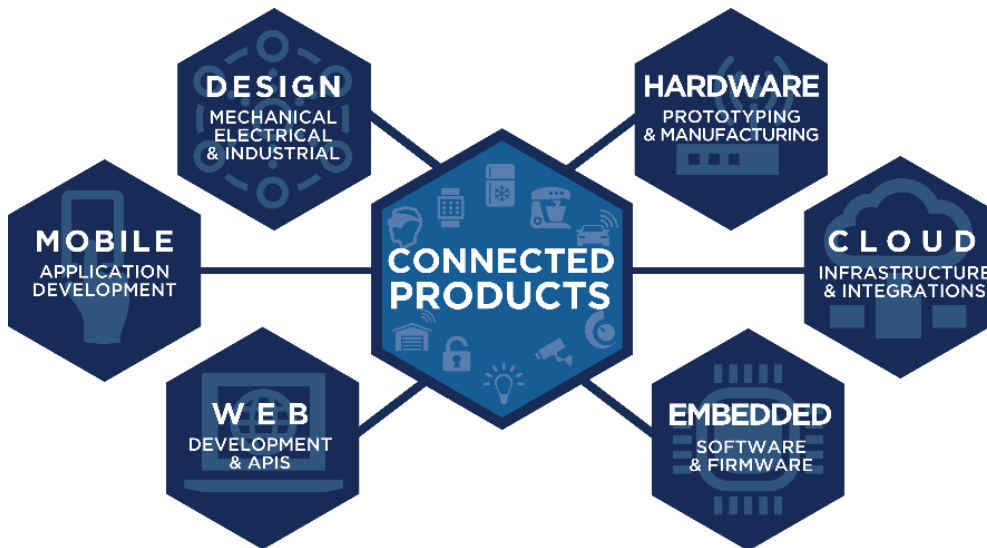
13. Solution Services

Rigado is a full-service design house offering end-to-end product solution development from concept to manufacturing. We can provide custom modules and do electrical and mechanical design, end product manufacturing, firmware and mobile development, and web and cloud integration. Please contact Rigado at info@rigado.com or 1-866-6-RIGADO for custom engineering options and fees.



14. Bluetooth Qualification

The BMD-330 Series modules are qualified as a Bluetooth Component (tested) for RF-PHY. This allows customers to use different SoftDevices that have been qualified by Nordic without the need to complete additional RF-PHY testing. To achieve Bluetooth End Product qualification, the Rigado RF-PHY QDID can be combined with Nordic QDIDs for the SoftDevice used when filing on the Bluetooth SIG website. The only testing required is for the Bluetooth profiles supported by the customer's product. Products with only custom profiles do not require any additional testing.

- RF-PHY v4.2 Component(Tested) Declaration ID **D030629** / QDID **81876**
- RF-PHY v5.0 Component(Tested) Declaration ID **D037298** / QDID **101625**

15. Regulatory Statements

15.1 FCC Statement:

This device has been tested and found to comply with part 15 of the FCC rules. These limits are designed to provide reasonable protection against harmful interference in a residential installation. This equipment generates, uses and can radiate radio frequency energy and, if not installed and used in accordance with the instructions, may cause harmful interference to radio communications. However, there is no guarantee that interference will not occur in a particular installation. If this equipment does cause harmful interference to radio or television reception, which can be determined by turning the equipment off and on, the user is encouraged to try to correct the interference by one or more of the following measures:

- Reorient or relocate the receiving antenna.
- Increase the separation between the equipment and the receiver
- Connect the equipment into an outlet on a circuit different from that to which the receiver is connected.
- Consult the dealer or an experienced radio/TV technician for help.

Operation is subjected to the following two conditions: (1) This device may no cause harmful interference, and (2) this device must accept any interference received, including interference that may cause undesired operation. Note: Modification to this product will void the user's authority to operate this equipment.

Note: Modification to this product will void the users' authority to operate this equipment.

15.2 FCC Important Notes

(1) FCC Radiation Exposure Statement

This equipment complies with FCC RF radiation exposure limits set forth for an uncontrolled environment. This transmitter must not be co-located or operating in conjunction with any other antenna or transmitter.

This equipment complies with Part 15 of the FCC Rules. Operation is subject the following two conditions:

- (1) This device may not cause harmful interference, and
- (2) This device must accept any interference received, including interference that may cause undesired operation.

The devices must be installed and used in strict accordance with the manufacturer's instructions as described in this document.

Caution!

The manufacturer is not responsible for any radio or TV interference caused by unauthorized modifications to this equipment. Such modification could void the user authority to operate the equipment.

(2) Co-location Warning:

This device and its antenna(s) must not be co-located or operating in conjunction with any other transmitter antenna.

(3) OEM integration instructions :

This device is intended only for OEM integrators under the following conditions:

The antenna and transmitter must not be co-located with any other transmitter or antenna. The module shall be only used with the integral antenna(s) that has been originally tested and certified with this module.

As long as the two (2) conditions above are met, further transmitter testing will not be required. However, the OEM integrator is still responsible for testing their end-product for any additional compliance requirements with this module installed (for example, digital device emission, PC peripheral requirements, etc.)

In the event that these conditions cannot be met (for example certain laptop configuration or co-location with another transmitter), then the FCC authorization for this module in combination with the host equipment is no longer considered valid and the FCC ID of the module cannot be used on the final product. In these and circumstance, the OEM integrator will be responsible for re-evaluating the end product (including the transmitter) and obtaining a separate FCC authorization.

Caution!

The OEM is still responsible for verifying end product compliance with FCC Part 15, subpart B limits for unintentional radiators through an accredited test facility.

(4) End product labeling :

The final end product must be labeled in a visible area with the following:

- “Contains **FCC ID: 2AA9B09**”
- Any similar wording that expresses the same meaning may be used.

The FCC Statement below should also be included on the label. When not possible, the FCC Statement should be included in the User Manual of the host device.

“This device complies with part 15 of the FCC rules.

Operation is subject to the following two conditions. (1) This device may not cause harmful interference. (2) This device must accept any interference received, including interference that may cause undesired operation.”

(5) Information regarding the end user manual :

The OEM integrator has to be aware not to provide information to the end user regarding how to install or remove this RF module in the user’s manual of the end product which integrates this module. The end user manual shall include all required regulatory information/warning as show in this manual (Section 15.2(4)).

15.3 IC Statement:

This device complies with Industry Canada license-exempt RSS standard(s). Operation is subject to the following two conditions: (1) this device may not cause interference, and (2) this device must accept any interference, including interference that may cause undesired operation of the device.

Le présent appareil est conforme aux CNR d'Industrie Canada applicables aux appareils radio exempts de licence. L'exploitation est autorisée aux deux conditions suivantes : (1) l'appareil ne doit pas produire de brouillage, et (2) l'utilisateur de l'appareil doit accepter tout brouillage radioélectrique subi, même si le brouillage est susceptible d'en compromettre le fonctionnement.

RF exposure warning: The equipment complies with RF exposure limits set forth for an uncontrolled environment. The antenna(s) used for this transmitter must not be co-located or operating in conjunction with any other antenna or transmitter.

Avertissement d'exposition RF: L'équipement est conforme aux limites d'exposition aux RF établies pour un incontrôlé environnement. L'antenne (s) utilisée pour ce transmetteur ne doit pas être co-localisés ou fonctionner en conjonction avec toute autre antenne ou transmetteur .

15.4 IC Important Notes

1. The OEM integrator must be aware not to provide information to the end user regarding how to install or remove this RF module in the user manual of the end product.

The user manual which is provided by OEM integrators for end users must include the following information in a prominent location.

2. To comply with IC RF exposure compliance requirements, the antenna used for this transmitter must not be co-located or operating in conjunction with any other antenna or transmitter, except in accordance with IC multi-transmitter product procedures.

3. The final system integrator must ensure there is no instruction provided in the user manual or customer documentation indicating how to install or remove the transmitter module except such device has implemented two-ways authentication between module and the host system.

4. The host device shall be properly labelled to identify the module within the host device. The end product must be labeled in a visible area with the following:

- “Contains **IC: 12208A-09**”

Any similar wording that expresses the same meaning may be used.

The IC Statement below should also be included on the label. When not possible, the IC Statement should be included in the User Manual of the host device.

“This device complies with Industry Canada license-exempt RSS standard(s). Operation is subject to the following two conditions: (1) this device may not cause interference, and (2) this device must accept any interference, including interference that may cause undesired operation of the device.

Le présent appareil est conforme aux CNR d'Industrie Canada applicables aux appareils radio exempts de licence. L'exploitation est autorisée aux deux conditions suivantes : (1) l'appareil ne doit pas produire de brouillage, et (2) l'utilisateur de l'appareil doit accepter tout brouillage radioélectrique subi, même si le brouillage est susceptible d'en compromettre le fonctionnement.”

15.5 CE Regulatory

The BMD-330 module is being tested and is expected to be compliant against the following standards. OEM integrators should consult with qualified test house to verify all regulatory requirements have been met for their complete device.

From Directive 2006/95/EC:

- EN 60950-1: 2006 + A11: 2009 + A1: 2010 + A12: 2011

From R&TTE Directive 1999/5/EC:

- ETSI EN 300 328 V 2.1.1

From Directive 2004/108/EC:

- ETSI EN 301 489-1 V2.1.1
- ETSI EN 301 489-17 V3.1.1

Declarations of Conformity and supporting test reports are available at www.rigado.com.

15.6 Australia / New Zealand

The BMD-330 module has been tested to comply with the AS/NZS 4268 :2012+AMDT 1:2013, Radio equipment and systems – Short range devices – Limits and methods of measurement. The report may be downloaded from www.rigado.com, and may be used as evidence in obtaining permission to use the RCM. Information on registration as a Responsible Party, license and labeling requirements may be found at the following websites:

Australia: <http://www.acma.gov.au/theACMA/radiocommunications-short-range-devices-standard-2004>

New Zealand: <http://www.rsm.govt.nz/compliance>

The A-Tick and C-Tick marks are being migrated to the Regulatory Compliance Mark (RCM). Only Australian-based and New Zealand-based companies who are registered may be granted permission to use the RCM. An Australian-based or New Zealand-based agent or importer may also register as a Responsible Party to use the RCM on behalf of a company not in Australia or New Zealand.

16. Solder Reflow Temperature-Time Profile

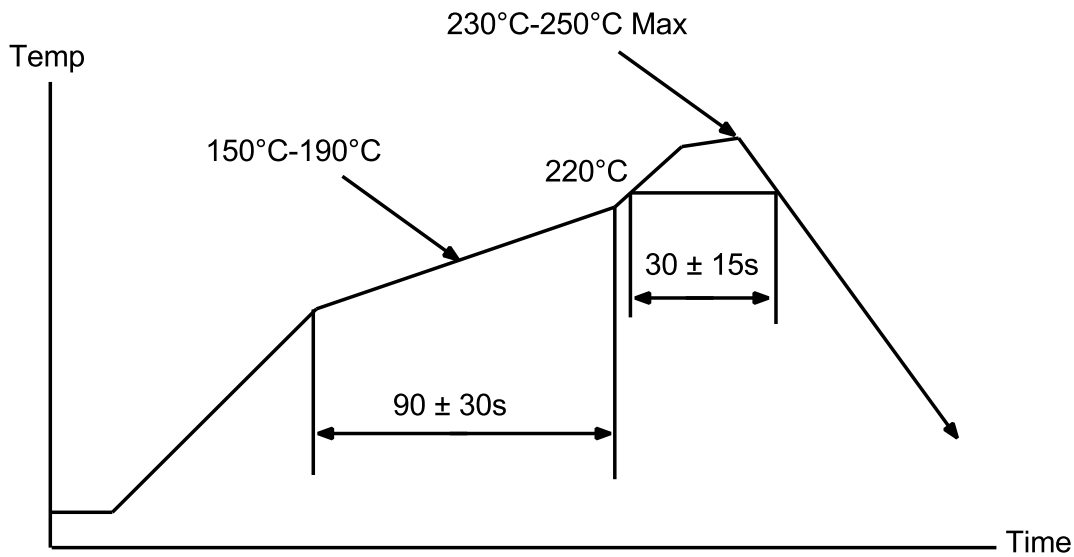

Figure 12 – Reflow Profile for Lead Free Solder

16.1 Moisture Sensitivity Level

The BMD-330 is rated for MSL 3, 168-hour floor life after opening.

17. Packaging and Labeling

17.1 Carrier Tape Dimensions

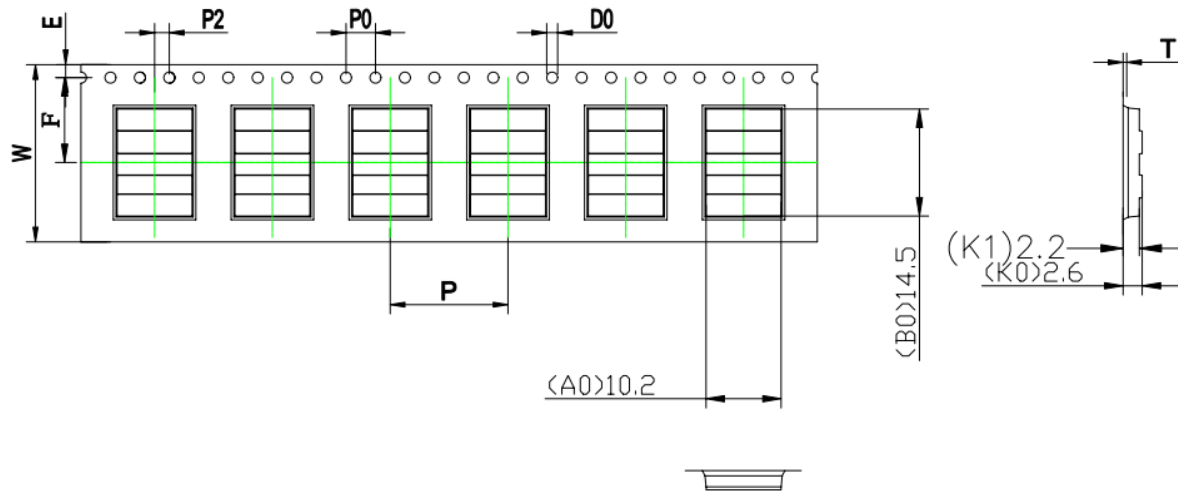

ITEM	W	A ₀	B ₀	K ₀	K ₁	P	F	E	D ₀	D ₁	P ₀	P ₂	T
DIM	24.0 ^{+0.30} _{-0.30}	10.2 ^{+0.10} _{-0.10}	14.5 ^{+0.10} _{-0.10}	2.6 ^{+0.10} _{-0.10}	2.2 ^{+0.00} _{-0.00}	16.0 ^{+0.10} _{-0.10}	11.5 ^{+0.10} _{-0.10}	1.75 ^{+0.10} _{-0.10}	1.50 ^{+0.10} _{-0.00}	0.00 ^{+0.10} _{-0.00}	4.00 ^{+0.10} _{-0.10}	2.00 ^{+0.10} _{-0.10}	0.30 ^{+0.05} _{-0.05}
ALTERNATE													

Figure 13 – BMD-330 Carrier Tape Dimensions

17.2 Reel Packaging

Modules come on 330mm reels loaded with 1000 modules. Each reel is placed in an antistatic bag with a desiccant pack and humidity card and placed in a 340x350x65mm box. On the outside of the bag an antistatic warning and reel label are adhered.

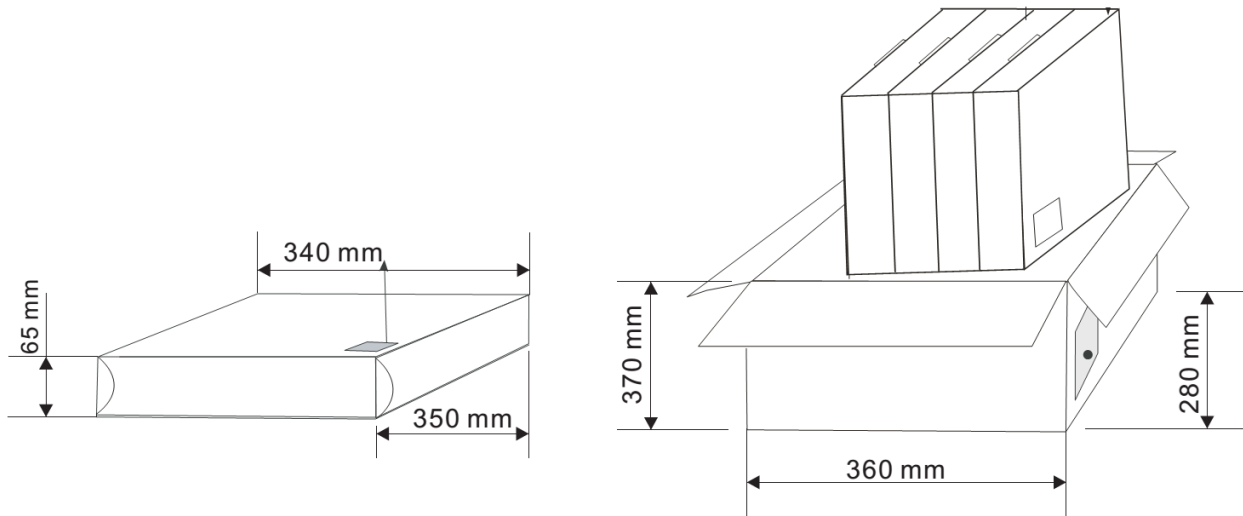

Figure 14 – Reel Cartons

17.3 Packaging Label

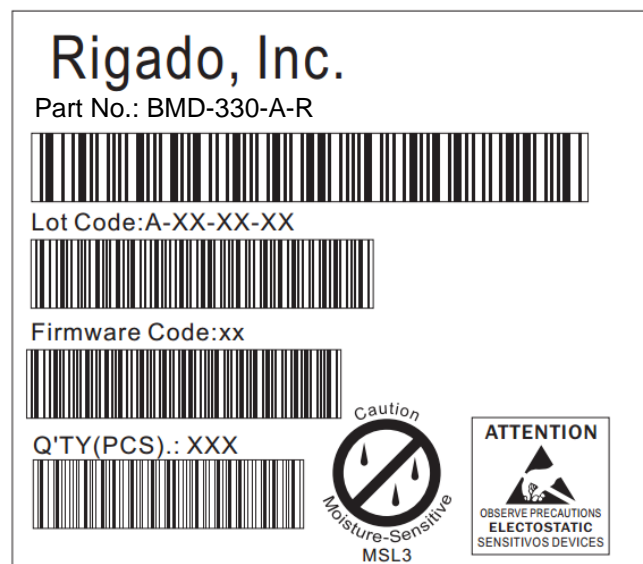

Figure 15 – Packaging Label

18. Cautions

- 1) The guidelines of this document should be followed in order to assure proper performance of the module.
- 2) This product is for use in office, business, and residential applications, but not medical devices.
- 3) This module may short-circuit. If a short circuit can result in serious damage or injury then failsafe precautions should be used. This could be accomplished by redundant systems and protection circuits.
- 4) Supply voltage to the module should not be higher than the specified inputs or reversed. Additionally, it should not contain noise, spikes, or AC ripple voltage.
- 5) Avoid use with other high frequency circuits.
- 6) Use methods to eliminate static electricity when working with the module as it can damage the components.
- 7) Contact with wires, the enclosure, or any other objects should be avoided.
- 8) Refer to the recommended pattern when designing for this module.
- 9) If hand soldering is used, be sure to use the precautions outlined in this document.
- 10) This module should be kept away from heat, both during storage and after installation.
- 11) Do not drop or physically shock the module.
- 12) Do not damage the interface surfaces of the module.
- 13) The module should not be mechanically stressed at any time (storage, handling, installation).
- 14) Do not store or expose this module to:
 - Humid or salty air conditions
 - High concentrations of corrosive gasses.
 - Long durations of direct sunlight.
 - Temperatures lower than -40°C or higher than 125°C.

19. Life Support Policy

This product is not designed to be used in a life support device or system, or in applications where there is potential for a failure or malfunction to, directly or indirectly, cause significant injury. By using this product in an application that poses these risks, such as described above, the customer is agreeing to indemnify Rigado for any damages that result.

20. Document History

Revision	Date	Changes / Notes
0.9	09/13/2017	Preliminary release
1.0	12/12/2017	Production Release

21. Related Documents

Rigado Documents:

- [BMD-300-Series-EVAL-UG: Evaluation Kit User Guide](#)
- [BMD-300 Series Data Sheet](#)

Nordic Documents:

Visit infocenter.nordicsemi.com for a comprehensive library of Nordic technical documentation.

- nRF52810 – [nRF52810 Product Specification](#)
- S132-SDS – [nRF52832 S132 Soft Device Specification](#)
- S112-SDS – [nRF52832 S112 Soft Device Specification](#)



Компания «ЭлектроПласт» предлагает заключение долгосрочных отношений при поставках импортных электронных компонентов на взаимовыгодных условиях!

Наши преимущества:

- Оперативные поставки широкого спектра электронных компонентов отечественного и импортного производства напрямую от производителей и с крупнейших мировых складов;
- Поставка более 17-ти миллионов наименований электронных компонентов;
- Поставка сложных, дефицитных, либо снятых с производства позиций;
- Оперативные сроки поставки под заказ (от 5 рабочих дней);
- Экспресс доставка в любую точку России;
- Техническая поддержка проекта, помощь в подборе аналогов, поставка прототипов;
- Система менеджмента качества сертифицирована по Международному стандарту ISO 9001;
- Лицензия ФСБ на осуществление работ с использованием сведений, составляющих государственную тайну;
- Поставка специализированных компонентов (Xilinx, Altera, Analog Devices, Intersil, Interpoint, Microsemi, Aeroflex, Peregrine, Syfer, Eurofarad, Texas Instrument, Miteq, Cobham, E2V, MA-COM, Hittite, Mini-Circuits, General Dynamics и др.);

Помимо этого, одним из направлений компании «ЭлектроПласт» является направление «Источники питания». Мы предлагаем Вам помощь Конструкторского отдела:

- Подбор оптимального решения, техническое обоснование при выборе компонента;
- Подбор аналогов;
- Консультации по применению компонента;
- Поставка образцов и прототипов;
- Техническая поддержка проекта;
- Защита от снятия компонента с производства.



Как с нами связаться

Телефон: 8 (812) 309 58 32 (многоканальный)

Факс: 8 (812) 320-02-42

Электронная почта: org@eplast1.ru

Адрес: 198099, г. Санкт-Петербург, ул. Калинина, дом 2, корпус 4, литера А.