

Series 95

Characteristics

The Series 95 PCB pushbuttons can be used in combination with 1.5 to 2.5 mm PCBs. The buttons are self-attaching until they are soldered. Depending on the design, they can be equipped with 2 or 3 SMD LEDs. The series is available in the following sizes:

- 19.05 × 19.05 mm
- 15.88 × 15.88 mm
- 12.7 × 12.7 mm

Functions

The Series 95 incorporates the following functions:

- Pushbutton
- Illuminated pushbutton

Market segments

The EAO Series 95 is especially suited for applications in the segment:

- Audio and video

Please refer to the EAO website to obtain detailed information regarding this series www.products.eao.com
Configure a product to your exact needs and request a quotation.

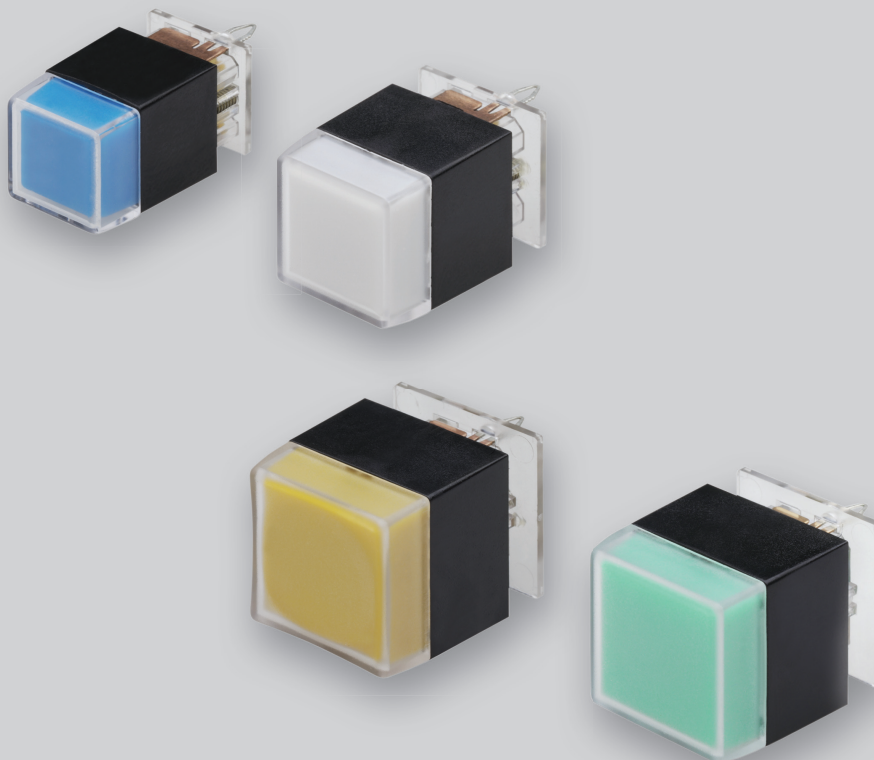

Overview**Printtasten**

Illuminated pushbutton

4

Accessories

5

Drawings

9

Technical data

10

Application guidelines

11

Index

12

95 PCB pushbuttons

Illuminated pushbutton, IP 40

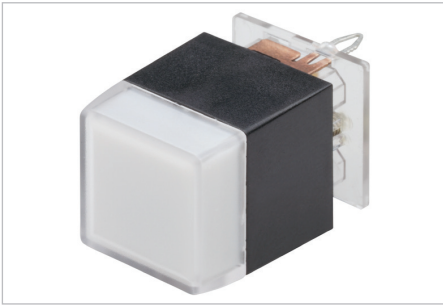

Product can differ from the current configuration.

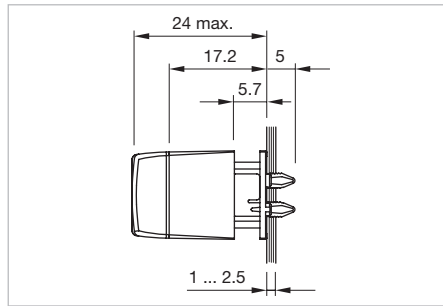

Dimensions [mm]

Equipment consisting of (schematic overview)



Lens



Diffuser





Switching element

Each Part Number listed below includes all the black components shown in the 3D-drawing.

Additional Information

- Lens plastic, colourless, transparent
- Suitable for PCB thickness 1.5 to 2.5 mm
- Special spring clip contacts position and hold the pushbutton in place during the soldering process. The soldering provides the contacting and the mechanical strength. The pushbutton is designed for panel mounting only.

Lens	Contacts	Switching action	Terminal	Part No.	Component layout	Weight
 <p>Illuminated pushbutton, Front dimension 19.05 x 19.05 mm</p>						
convexe mat	1 NO	B	PCB	95-414.730	1	0.004 kg
concave mat	1 NO	B	PCB	95-414.740	1	0.004 kg
flat high gloss finished	1 NO	B	PCB	95-414.750	1	0.004 kg
concave high gloss finished	1 NO	B	PCB	95-414.770	1	0.004 kg
 <p>Illuminated pushbutton, Front dimension 15.88 x 15.88 mm</p>						
flat mat	1 NO	B	PCB	95-515.720	2	0.004 kg
concave mat	1 NO	B	PCB	95-515.740	2	0.004 kg
flat high gloss finished	1 NO	B	PCB	95-515.750	2	0.004 kg
concave high gloss finished	1 NO	B	PCB	95-515.770	2	0.004 kg
 <p>Illuminated pushbutton, Front dimension 12.7 x 12.7 mm</p>						
flat mat	1 NO	B	PCB	95-313.720	3	0.003 kg
flat high gloss finished	1 NO	B	PCB	95-313.750	3	0.003 kg





Contacts: NO = Normally open
 Switching action: B = Momentary
 The component layouts you will find from page 9

Front



Lens

Additional Information

- Lens plastic, colourless, transparent

Dimension	Lens	Part No.	Weight
 <p>Lens</p>			
15.88 x 15.88 mm	flat mat	95-705.720	0.001 kg
19.05 x 19.05 mm	flat mat	95-704.720	0.001 kg
	flat high gloss finished	95-704.750	0.001 kg
12.7 x 12.7 mm	flat mat	95-703.720	0.001 kg
	flat high gloss finished	95-703.750	0.001 kg
 <p>Lens</p>			
15.88 x 15.88 mm	convexe mat	95-705.730	0.001 kg
19.05 x 19.05 mm	convexe mat	95-704.730	0.001 kg
	convexe high gloss finished	95-704.760	0.001 kg
 <p>Lens</p>			
15.88 x 15.88 mm	concave mat	95-705.740	0.001 kg
	concave high gloss finished	95-705.770	0.001 kg
19.05 x 19.05 mm	concave mat	95-704.740	0.001 kg
	concave high gloss finished	95-704.770	0.001 kg
 <p>Lens</p>			
19.05 x 38.1 mm	concave mat	95-724.740	0.002 kg

Diffuser



Dimension	Diffuser	Part No.	Weight
 <p>Diffuser</p>			
19.05 x 19.05 mm	Plastic red translucent	95-804.220	0.001 kg
	Plastic yellow translucent	95-804.420	0.001 kg
	Plastic green translucent	95-804.520	0.001 kg
	Plastic colourless transparent	95-804.720	0.001 kg
	Plastic white translucent	95-804.920	0.001 kg
15.88 x 15.88 mm	Plastic white translucent	95-805.920	0.001 kg
12.7 x 12.7 mm	Plastic yellow translucent	95-803.420	0.001 kg
	Plastic green translucent	95-803.520	0.001 kg
	Plastic colourless transparent	95-803.720	0.001 kg
	Plastic white translucent	95-803.920	0.001 kg
 <p>Diffuser</p>			
19.05 x 38.1 mm	Plastic white translucent	95-824.920	0.001 kg

Rear side

Switching element

Additional Information

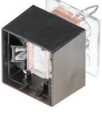
- Switching system slow-make element
- For combining with lens and diffuser
- Suitable for PCB thickness 1.5 to 2.5 mm
- Special spring clip contacts position and hold the pushbutton in place during the soldering process. The soldering provides the contacting and the mechanical strength. The pushbutton is designed for panel mounting only.

Contacts	Switching action	Terminal	Part No.	Component layout	Weight
 <p>Switching element square, 19.05 x 19.05 mm</p>					
1 NO	B	PCB	95-414.000	1	0.003 kg
 <p>Switching element square, 15.88 x 15.88 mm</p>					
1 NO	B	PCB	95-515.000	2	0.002 kg
 <p>Switching element square, 12.7 x 12.7 mm</p>					
1 NO	B	PCB	95-313.000	3	0.002 kg

Contacts: NO = Normally open
 Switching action: B = Momentary
 The component layouts you will find from page 9

Mounting

Lens remover

Additional Information

- In case a lens gets damaged when being removed, it has to be replaced

Part No.	Weight
 Lens remover	
95-900.005	0.003 kg

Mounting tool

Part No.	Weight
 Mounting tool	
95-900.009	0.003 kg

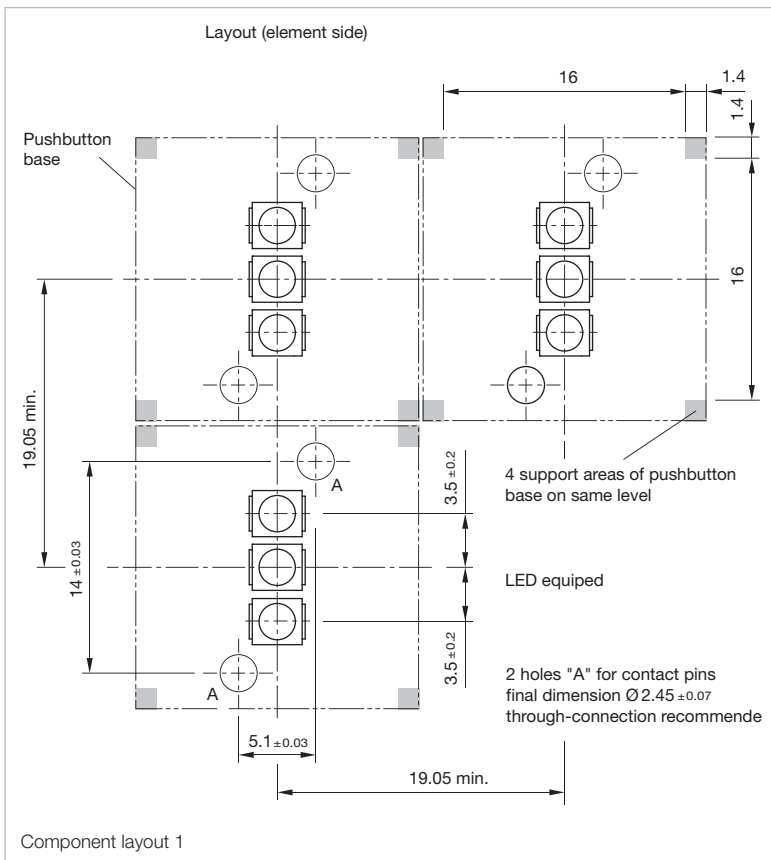
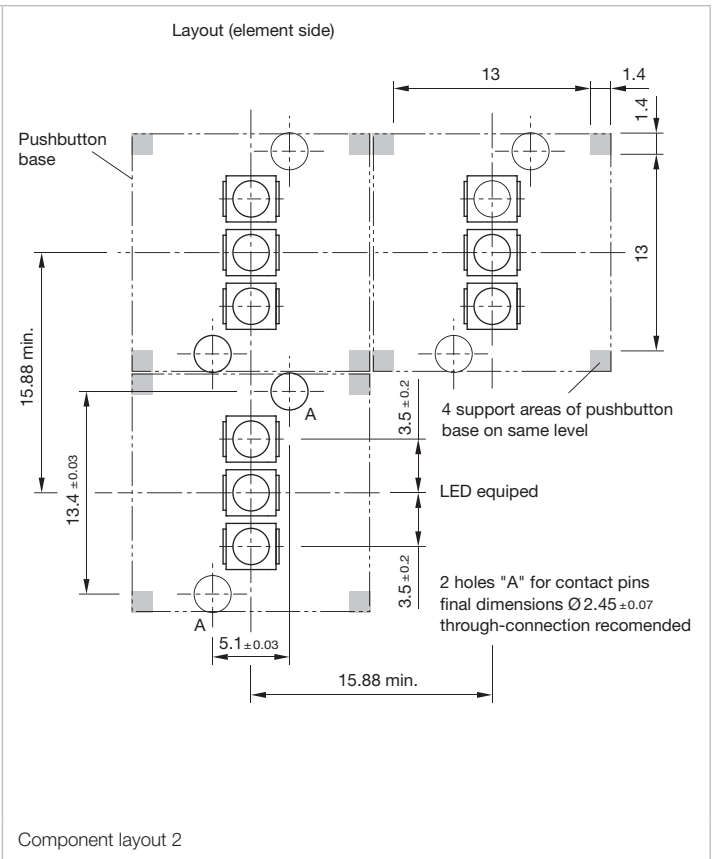
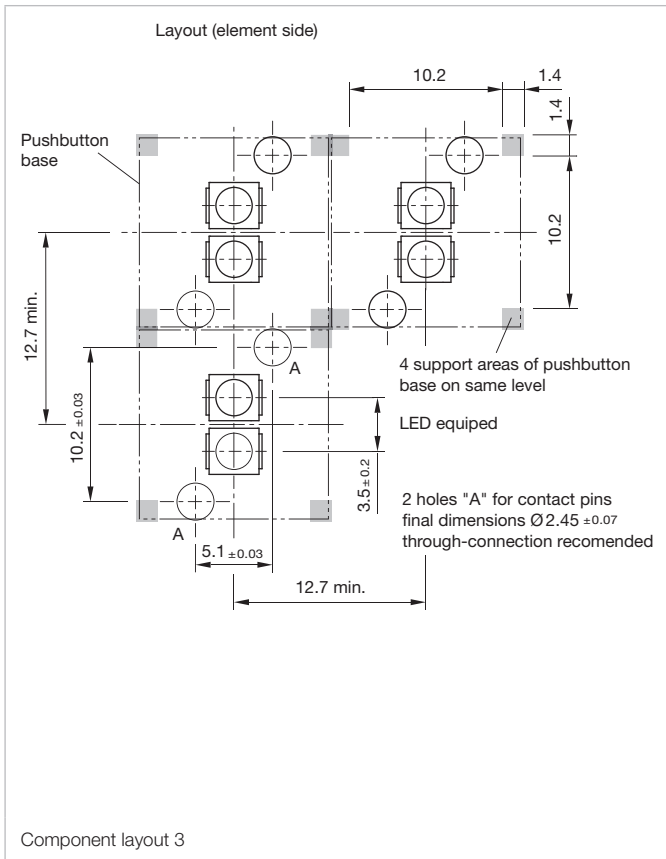

Pushbutton and Illuminated pushbutton

Switching system

Gold plated momentary contact, 1 normally open, self-cleaning

Material

Plastic parts

PC, as per UL 94 HB, Cd-free

Material of contacts

CuSn, contact gold-plated, soldering terminal tinned

Mechanical characteristics

Actuating travel

4.5 mm

Actuating force

3N to end position

Switching point

2.3 mm \pm 0.8 mm at operation

Resistance to heat of soldering

260 °C, 5 s, per IEC60068-2-20

Life time

> 5 million operations, as per IEC 60512-5-9a

Electrical characteristics

Illumination

recommended SMD-LED types:
P-LCC package or similar, radiation angle approx. 120°;
use of smaller SMD-LED is possible.

SMD-LED configurations size:

max. 2 SMD-LEDs for switch size 12.7 mm

max. 3 SMD-LEDs for switch size 15.88 mm and 19.05 mm,
single colour or multi-colour.

Height of SMD-LED:

max. 2.1 mm

Electric strength

\leq 50 m Ω , as per IEC 60512-2-2b at new state

Isolation resistance

$>$ 1 T Ω , as per IEC 60512-2-3a between contacts

Switch rating

min. 1 mVDC, 100 μ A

max. 48 VDC, 50 mA

Electric strength

2.5 kVAC, as per IEC 60512-2-11

Environmental conditions

Front protection

IP 40 before front plate for complete switch

Operating temperature

-25 °C ... +70 °C

Storage temperature

-40 °C ... +80 °C

Vibration resistance

10g, at 10–2000 Hz, 0.75 mm, as per IEC 60512-4-4

Shock resistance

Pushbutton and Illuminated pushbutton 50g, 11 ms,
as per IEC 60512-4-3

Approvals

Declaration of conformity

CE

EAO reserves the right to alter specifications without further notice.

Suppressor circuits

When switching inductive loads such as relays, DC motors, and DC solenoids, it is always important to absorb surges (e.g. with a diode) to protect the contacts. When these inductive loads are switched off, a counter emf can severely damage switch contacts and greatly shorten lifetime.

Fig. 1 shows an inductive load with a free-wheeling diode connected in parallel. This free-wheeling diode provides a path for the inductor current to flow when the current is interrupted by the switch. Without this free-wheeling diode, the voltage across the coil will be limited only by dielectric breakdown voltages of the circuit or parasitic elements of the coil. This voltage can be kilovolts in amplitude even when nominal circuit voltages are low (e.g. 12VDC) see Fig. 2.

The free-wheeling diode should be chosen so that the reverse breakdown voltage is greater than the voltage driving the inductive load. The DC blocking voltage (V_R) of the free-wheeling diode can be found in the datasheet of a diode. The forward current should be equal or greater than the maximum current flowing through the load.

To get an efficient protection, the free-wheeling diode must be connected as close as possible to the inductive load!

Switching with inductive load
Fig. 1

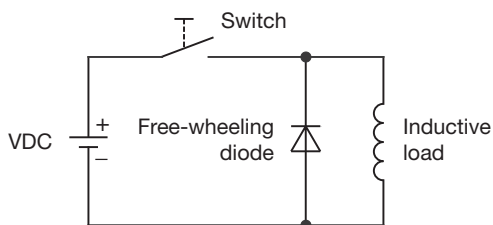

Counter EMF
over load without free-wheeling diode
Fig. 2



Index

Index from Part No.

Part No.	Page
95-313.000	7
95-313.720	4
95-313.750	4
95-414.000	7
95-414.730	4
95-414.740	4
95-414.750	4
95-414.770	4
95-515.000	7
95-515.720	4
95-515.740	4
95-515.750	4
95-515.770	4
95-703.720	5
95-703.750	5
95-704.720	5
95-704.730	5
95-704.740	5
95-704.750	5
95-704.760	5
95-704.770	5
95-705.720	5
95-705.730	5
95-705.740	5
95-705.770	5
95-724.740	5
95-803.420	6
95-803.520	6
95-803.720	6
95-803.920	6
95-804.220	6
95-804.420	6
95-804.520	6
95-804.720	6
95-804.920	6
95-805.920	6
95-824.920	6
95-900.005	8
95-900.009	8



Компания «ЭлектроПласт» предлагает заключение долгосрочных отношений при поставках импортных электронных компонентов на взаимовыгодных условиях!

Наши преимущества:

- Оперативные поставки широкого спектра электронных компонентов отечественного и импортного производства напрямую от производителей и с крупнейших мировых складов;
- Поставка более 17-ти миллионов наименований электронных компонентов;
- Поставка сложных, дефицитных, либо снятых с производства позиций;
- Оперативные сроки поставки под заказ (от 5 рабочих дней);
- Экспресс доставка в любую точку России;
- Техническая поддержка проекта, помощь в подборе аналогов, поставка прототипов;
- Система менеджмента качества сертифицирована по Международному стандарту ISO 9001;
- Лицензия ФСБ на осуществление работ с использованием сведений, составляющих государственную тайну;
- Поставка специализированных компонентов (Xilinx, Altera, Analog Devices, Intersil, Interpoint, Microsemi, Aeroflex, Peregrine, Syfer, Eurofarad, Texas Instrument, Miteq, Cobham, E2V, MA-COM, Hittite, Mini-Circuits, General Dynamics и др.);

Помимо этого, одним из направлений компании «ЭлектроПласт» является направление «Источники питания». Мы предлагаем Вам помощь Конструкторского отдела:

- Подбор оптимального решения, техническое обоснование при выборе компонента;
- Подбор аналогов;
- Консультации по применению компонента;
- Поставка образцов и прототипов;
- Техническая поддержка проекта;
- Защита от снятия компонента с производства.



Как с нами связаться

Телефон: 8 (812) 309 58 32 (многоканальный)

Факс: 8 (812) 320-02-42

Электронная почта: org@eplast1.ru

Адрес: 198099, г. Санкт-Петербург, ул. Калинина, дом 2, корпус 4, литера А.