

Hybrid motor starter - ELR H3-I-PT- 24DC/500AC-0,6 - 2903920

Please be informed that the data shown in this PDF Document is generated from our Online Catalog. Please find the complete data in the user's documentation. Our General Terms of Use for Downloads are valid (<http://phoenixcontact.com/download>)



Hybrid motor starter for starting 3~ AC motors up to 550 V AC, with 24 V DC input, 0.6 A output current, adjustable overload shutdown, and push-in connection.

The figure shows the ELR H3-IES-PT- 24DC/500AC-0,6 version

Product Features



Key commercial data

Packing unit	1 pc
Custom tariff number	85371099
Country of origin	Germany

Technical data

Input data

Input name	Device supply
Rated control supply voltage U_S	24 V DC (According to IEC 60947-1)
Voltage range with reference to U_S	0.8 ... 1.25
Rated control supply current I_S	≤ 40 mA
Protective circuit	Protection against polarity reversal
	Surge protection
Operating voltage display	Green LED
Status display	Yellow LED
Indication	Red LED
Input name	Control input
Typical input current at U_N	≤ 5 mA
Rated control supply current I_S	≤ 40 mA (According to IEC 60947-1)
Rated actuating voltage U_C	24 V DC

Hybrid motor starter - ELR H3-I-PT- 24DC/500AC-0,6 - 2903920

Technical data

Input data

Voltage range with reference to U_c	0.8 ... 1.25
Rated actuating current I_c	≤ 5 mA
Protective circuit	Protection against polarity reversal
Typical response time	< 35 ms
Typical turn-off time	< 40 ms

Output data load output

Rated operating voltage U_e	500 V AC
Operating voltage range	42 V AC ... 550 V AC
Load current	max. 600 mA (see derating curve)
Min. load current	75 mA
Rated operating current at AC-51	0.6 A
Rated operating current at AC-53a	0.6 A
Leakage current	0 mA
Residual voltage	< 0.2 V (at I_e)
Protective circuit	Surge protection Varistor

Output data reply output

Note	Confirmation 01: floating change-over contact, signal contact
Contact type	1 PDT
Contact material	AgSnO ₂ , hard gold-plated
Maximum switching voltage	30 V AC
	36 V DC
Minimum switching voltage	100 mV AC/DC (at 10 mA)
Min. switching current	1 mA (at 24 V)
Maximum inrush current	50 mA
Limiting continuous current	50 mA
Interrupting rating (ohmic load) max.	1.2 W (at 24 V DC)
Note	the following values are applicable if a gold layer is destroyed
Maximum switching voltage	250 V AC/DC
Minimum switching voltage	5 V (at 100 mA)
Min. switching current	10 mA (at 12 V)
Limiting continuous current	6 A
Interrupting rating (ohmic load) max.	140 W (at 24 V DC)
	20 W (at 48 V DC)
	18 W (at 60 V DC)
	23 W (at 110 V DC)
	40 W (at 220 V DC)

Hybrid motor starter - ELR H3-I-PT- 24DC/500AC-0,6 - 2903920

Technical data

Output data reply output

	1500 VA (for 250 V AC)
Switching capacity according to IEC 60947-5-1	2 A (at 24 V, DC13)
	0.2 A (at 110 V, DC13)
	0.1 A (at 220 V, DC13)
	3 A (at 24 V, AC15)
	3 A (at 120 V, AC15)
	3 A (at 230 V, AC15)

Measuring technology and signaling contact

Measuring via	Current transformer for line current on L1 and L3
---------------	---

Connection data

Connection method	Push-in connection
Stripping length	10 mm
Conductor cross section solid min.	0.2 mm ²
Conductor cross section solid max.	2.5 mm ²
Conductor cross section flexible min.	0.2 mm ²
Conductor cross section flexible max.	2.5 mm ²
Conductor cross section AWG min.	24
Conductor cross section AWG max.	14

General

Test voltage input/output	4 kV _{rms}
Mounting position	Vertical (horizontal DIN rail)
Assembly instructions	can be aligned with spacing: see derating
Operating mode	100% operating factor
Designation	Air clearances and creepage distances between the power circuits
Standards/regulations	DIN EN 50178
Insulation	Safe isolation (EN 50178) for mains voltage ≤ 500 V AC
	Safe isolation (IEC 60947-1) for mains voltage ≤ 300 V AC
	Basic insulation (IEC 60947-1) for mains voltage of 300 ... 500 V AC
Pollution degree	2
Surge voltage category	III
Designation	Standards/regulations
Standards/regulations	IEC 60947-1
	EN 60947-4-2

Dimensions

Width	22.5 mm
-------	---------

Hybrid motor starter - ELR H3-I-PT- 24DC/500AC-0,6 - 2903920

Technical data

Dimensions

Height	99 mm
Depth	114.5 mm

Ambient conditions

Ambient temperature (operation)	-25 °C ... 70 °C
Ambient temperature (storage/transport)	-40 °C ... 80 °C
Degree of protection	IP20

UL data

Short-circuit current rating (SCCR)	100 kA (500 V AC (30 A CC/30 A J (high fault) fuse))
	5 kA (500 V AC (20 A RK5 (standard fault) fuse))

Classifications

eCl@ss

eCl@ss 4.0	27371102
eCl@ss 4.1	27371102
eCl@ss 5.0	27371601
eCl@ss 5.1	27371601
eCl@ss 6.0	27371601
eCl@ss 7.0	27371601
eCl@ss 8.0	27370905

ETIM

ETIM 3.0	EC000066
ETIM 4.0	EC000066
ETIM 5.0	EC001037

UNSPSC

UNSPSC 6.01	30211915
UNSPSC 7.0901	39121514
UNSPSC 11	39121514
UNSPSC 12.01	39121514
UNSPSC 13.2	39121514

Approvals

Approvals

Hybrid motor starter - ELR H3-I-PT- 24DC/500AC-0,6 - 2903920

Approvals

Approvals

UL Listed / cUL Listed / IECEE CB Scheme / UL Listed / cUL Listed / cULus Listed

Ex Approvals

Approvals submitted

Approval details

UL Listed 

cUL Listed 

IECEE CB Scheme 

UL Listed 

cUL Listed 

cULus Listed 

Drawings

Hybrid motor starter - ELR H3-I-PT- 24DC/500AC-0,6 - 2903920

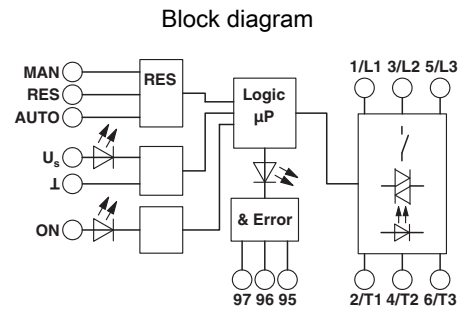
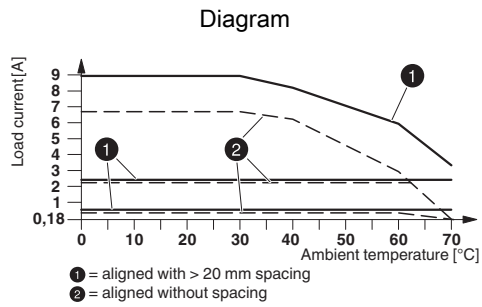

Derating diagram



Компания «ЭлектроПласт» предлагает заключение долгосрочных отношений при поставках импортных электронных компонентов на взаимовыгодных условиях!

Наши преимущества:

- Оперативные поставки широкого спектра электронных компонентов отечественного и импортного производства напрямую от производителей и с крупнейших мировых складов;
- Поставка более 17-ти миллионов наименований электронных компонентов;
- Поставка сложных, дефицитных, либо снятых с производства позиций;
- Оперативные сроки поставки под заказ (от 5 рабочих дней);
- Экспресс доставка в любую точку России;
- Техническая поддержка проекта, помощь в подборе аналогов, поставка прототипов;
- Система менеджмента качества сертифицирована по Международному стандарту ISO 9001;
- Лицензия ФСБ на осуществление работ с использованием сведений, составляющих государственную тайну;
- Поставка специализированных компонентов (Xilinx, Altera, Analog Devices, Intersil, Interpoint, Microsemi, Aeroflex, Peregrine, Syfer, Eurofarad, Texas Instrument, Miteq, Cobham, E2V, MA-COM, Hittite, Mini-Circuits, General Dynamics и др.);

Помимо этого, одним из направлений компании «ЭлектроПласт» является направление «Источники питания». Мы предлагаем Вам помощь Конструкторского отдела:

- Подбор оптимального решения, техническое обоснование при выборе компонента;
- Подбор аналогов;
- Консультации по применению компонента;
- Поставка образцов и прототипов;
- Техническая поддержка проекта;
- Защита от снятия компонента с производства.



Как с нами связаться

Телефон: 8 (812) 309 58 32 (многоканальный)

Факс: 8 (812) 320-02-42

Электронная почта: org@eplast1.ru

Адрес: 198099, г. Санкт-Петербург, ул. Калинина, дом 2, корпус 4, литера А.