

Photomicrosensor (Transmissive) EE-SX398/498

⚠ Be sure to read *Precautions* on page 25.

■ Dimensions

Note: All units are in millimeters unless otherwise indicated.

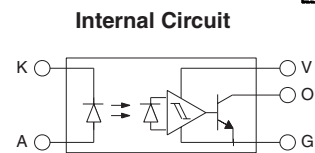
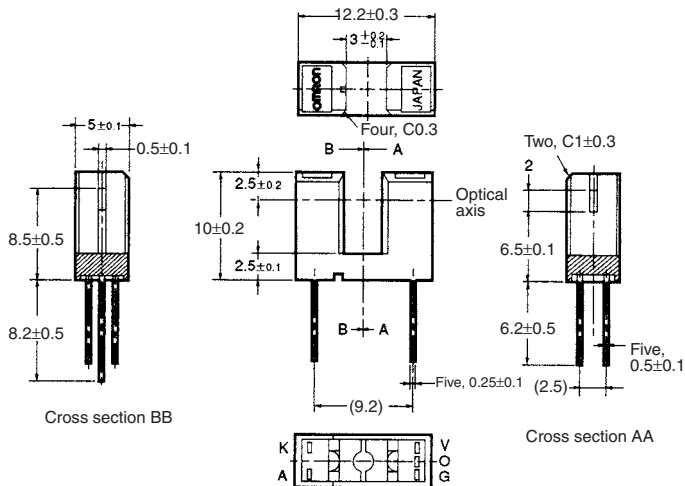

Terminal No.	Name
A	Anode
K	Cathode
V	Power supply (Vcc)
O	Output (OUT)
G	Ground (GND)

Unless otherwise specified, the tolerances are as shown below.

Dimensions	Tolerance
3 mm max.	±0.3
3 < mm ≤ 6	±0.375
6 < mm ≤ 10	±0.45
10 < mm ≤ 18	±0.55
18 < mm ≤ 30	±0.65

■ Features

- Incorporates an IC chip with a built-in detector element and amplifier.
- Incorporates a detector element with a built-in temperature compensation circuit.
- A wide supply voltage range: 4.5 to 16 VDC
- Directly connects with C-MOS and TTL.
- High resolution with a 0.5-mm-wide sensing aperture.
- Dark ON model (EE-SX398)
- Light ON model (EE-SX498)

■ Absolute Maximum Ratings (Ta = 25°C)

Item	Symbol	Rated value
Emitter	Forward current	I _F 50 mA (see note 1)
	Reverse voltage	V _R 4 V
Detector	Power supply voltage	V _{CC} 16 V
	Output voltage	V _{OUT} 28 V
	Output current	I _{OUT} 16 mA
	Permissible output dissipation	P _{OUT} 250 mW (see note 1)
Ambient temperature	Operating	T _{opr} -40°C to 75°C
	Storage	T _{stg} -40°C to 85°C
Soldering temperature	T _{sol}	260°C (see note 2)

- Note:**
1. Refer to the temperature rating chart if the ambient temperature exceeds 25°C.
 2. Complete soldering within 10 seconds.

■ Electrical and Optical Characteristics (Ta = 25°C)

Item	Symbol	Value	Condition
Emitter	Forward voltage	V _F 1.2 V typ., 1.5 V max.	I _F = 20 mA
	Reverse current	I _R 0.01 μA typ., 10 μA max.	V _R = 4 V
	Peak emission wavelength	λ _p 940 nm typ.	I _F = 20 mA
Detector	Low-level output voltage	V _{OL} 0.12 V typ., 0.4 V max.	V _{CC} = 4.5 to 16 V, I _{OL} = 16 mA, I _F = 0 mA (EE-SX398), I _F = 5 mA (EE-SX498)
	High-level output voltage	V _{OH} 15 V min.	V _{CC} = 16 V, R _L = 1 kΩ, I _F = 5 mA (EE-SX398), I _F = 0 mA (EE-SX498)
	Current consumption	I _{CC} 3.2 mA typ., 10 mA max.	V _{CC} = 16 V
	Peak spectral sensitivity wavelength	λ _p 870 nm typ.	V _{CC} = 4.5 to 16 V
LED current when output is OFF	I _{FT}	2 mA typ., 5 mA max.	V _{CC} = 4.5 to 16 V
LED current when output is ON			
Hysteresis	ΔH	15% typ.	V _{CC} = 4.5 to 16 V (see note 1)
Response frequency	f	3 kHz min.	V _{CC} = 4.5 to 16 V, I _F = 15 mA, I _{OL} = 16 mA (see note 2)
Response delay time	t _{PLH} (t _{PHL})	3 μs typ.	V _{CC} = 4.5 to 16 V, I _F = 15 mA, I _{OL} = 16 mA (see note 3)
Response delay time	t _{PHL} (t _{PLH})	20 μs typ.	V _{CC} = 4.5 to 16 V, I _F = 15 mA, I _{OL} = 16 mA (see note 3)

Note: 1. Hysteresis denotes the difference in forward LED current value, expressed in percentage, calculated from the respective forward LED currents when the photo IC in turned from ON to OFF and when the photo IC in turned from OFF to ON.

2. The value of the response frequency is measured by rotating the disk as shown below.

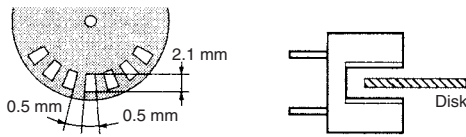

3. The following illustrations show the definition of response delay time. The value in the parentheses applies to the EE-SX498.

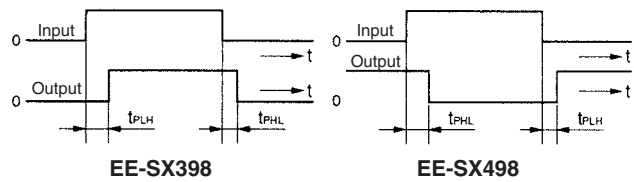

Engineering Data

Note: The values in the parentheses apply to the EE-SX498.

Forward Current vs. Collector Dissipation Temperature Rating

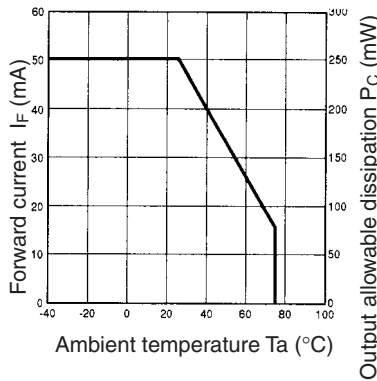

Forward Current vs. Forward Voltage Characteristics (Typical)

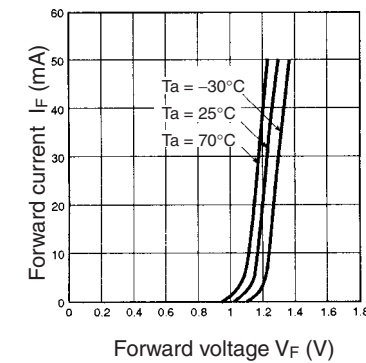

LED Current vs. Supply Voltage (Typical)

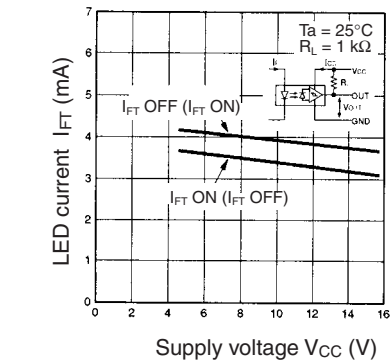

LED Current vs. Ambient Temperature Characteristics (Typical)

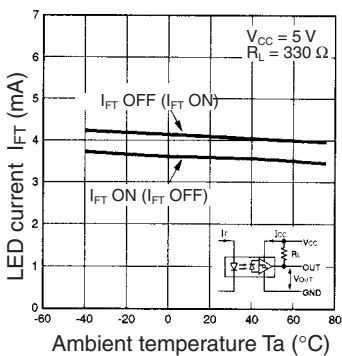

Low-level Output Voltage vs. Output Current (Typical)

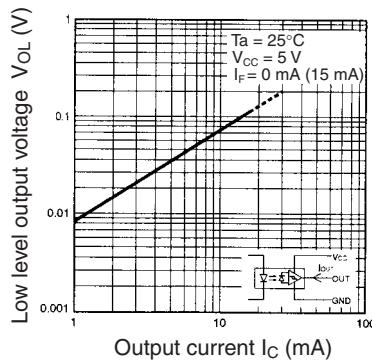

Low-level Output Voltage vs. Ambient Temperature Characteristics (Typical)

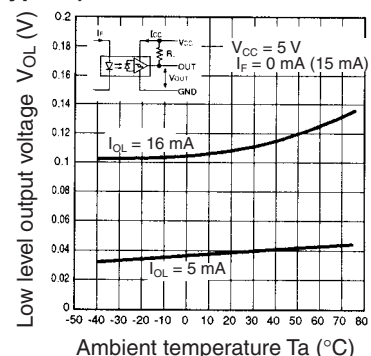

Current Consumption vs. Supply Voltage (Typical)

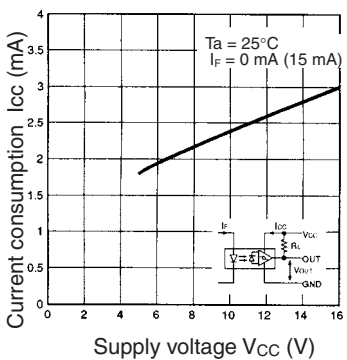

Response Delay Time vs. Forward Current (Typical)

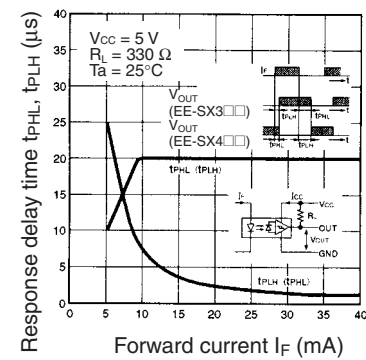

Repeat Sensing Position Characteristics (Typical)

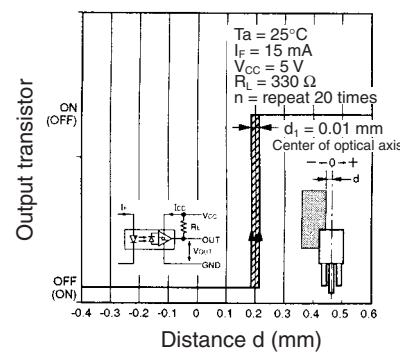



Компания «ЭлектроПласт» предлагает заключение долгосрочных отношений при поставках импортных электронных компонентов на взаимовыгодных условиях!

Наши преимущества:

- Оперативные поставки широкого спектра электронных компонентов отечественного и импортного производства напрямую от производителей и с крупнейших мировых складов;
- Поставка более 17-ти миллионов наименований электронных компонентов;
- Поставка сложных, дефицитных, либо снятых с производства позиций;
- Оперативные сроки поставки под заказ (от 5 рабочих дней);
- Экспресс доставка в любую точку России;
- Техническая поддержка проекта, помощь в подборе аналогов, поставка прототипов;
- Система менеджмента качества сертифицирована по Международному стандарту ISO 9001;
- Лицензия ФСБ на осуществление работ с использованием сведений, составляющих государственную тайну;
- Поставка специализированных компонентов (Xilinx, Altera, Analog Devices, Intersil, Interpoint, Microsemi, Aeroflex, Peregrine, Syfer, Eurofarad, Texas Instrument, Miteq, Cobham, E2V, MA-COM, Hittite, Mini-Circuits, General Dynamics и др.);

Помимо этого, одним из направлений компании «ЭлектроПласт» является направление «Источники питания». Мы предлагаем Вам помощь Конструкторского отдела:

- Подбор оптимального решения, техническое обоснование при выборе компонента;
- Подбор аналогов;
- Консультации по применению компонента;
- Поставка образцов и прототипов;
- Техническая поддержка проекта;
- Защита от снятия компонента с производства.



Как с нами связаться

Телефон: 8 (812) 309 58 32 (многоканальный)

Факс: 8 (812) 320-02-42

Электронная почта: org@eplast1.ru

Адрес: 198099, г. Санкт-Петербург, ул. Калинина, дом 2, корпус 4, литера А.