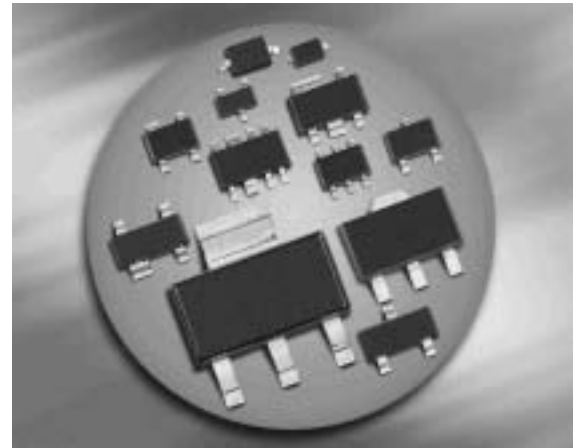
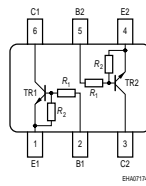
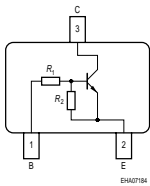

NPN Silicon Digital Transistor

- Switching in circuit, inverter, interface circuit, drive circuit
- Built in bias resistor ($R_1 = 10\text{ k}\Omega$, $R_2 = 10\text{ k}\Omega$)
- BCR133S: Two internally isolated transistors with good matching in one multichip package
- BCR133S: For orientation in reel see package information below
- Pb-free (RoHS compliant) package¹⁾
- Qualified according AEC Q101

BCR133/W/F
BCR133S

Type	Marking	Pin Configuration						Package
		1=B	2=E	3=C	-	-	-	
BCR133	WCs	1=B	2=E	3=C	-	-	-	SOT23
BCR133F	WCs	1=B	2=E	3=C	-	-	-	TSFP-3
BCR133S	WCs	1=E1	2=B1	3=C2	4=E2	5=B2	6=C1	SOT363
BCR133W	WCs	1=B	2=E	3=C	-	-	-	SOT323

¹Pb-containing package may be available upon special request

Maximum Ratings

Parameter	Symbol	Value	Unit
Collector-emitter voltage	V_{CEO}	50	V
Collector-base voltage	V_{CBO}	50	
Input forward voltage	$V_{i(fwd)}$	40	
Input reverse voltage	$V_{i(rev)}$	10	
Collector current	I_C	100	mA
Total power dissipation- BCR133, $T_S \leq 102^\circ\text{C}$ BCR133S, $T_S \leq 115^\circ\text{C}$ BCR133W, $T_S \leq 124^\circ\text{C}$ BCR133F, $T_S \leq \text{tbd}$	P_{tot}	200 250 250 250	mW
Junction temperature	T_j	150	°C
Storage temperature	T_{stg}	-65 ... 150	

Thermal Resistance

Parameter	Symbol	Value	Unit
Junction - soldering point ¹⁾	R_{thJS}		K/W
BCR133		≤ 240	
BCR133S		≤ 140	
BCR133W		≤ 105	
BCR133F		$\leq \text{tbd}$	

¹For calculation of R_{thJA} please refer to Application Note Thermal Resistance

Electrical Characteristics at $T_A = 25^\circ\text{C}$, unless otherwise specified

Parameter	Symbol	Values			Unit
		min.	typ.	max.	
DC Characteristics					
Collector-emitter breakdown voltage $I_C = 100 \mu\text{A}, I_B = 0$	$V_{(BR)CEO}$	50	-	-	V
Collector-base breakdown voltage $I_C = 10 \mu\text{A}, I_E = 0$	$V_{(BR)CBO}$	50	-	-	
Collector-base cutoff current $V_{CB} = 40 \text{ V}, I_E = 0$	I_{CBO}	-	-	100	nA
Emitter-base cutoff current $V_{EB} = 10 \text{ V}, I_C = 0$	I_{EBO}	-	-	0.75	mA
DC current gain ¹⁾ $I_C = 5 \text{ mA}, V_{CE} = 5 \text{ V}$	h_{FE}	30	-	-	-
Collector-emitter saturation voltage ¹⁾ $I_C = 10 \text{ mA}, I_B = 0.5 \text{ mA}$	V_{CEsat}	-	-	0.3	V
Input off voltage $I_C = 100 \mu\text{A}, V_{CE} = 5 \text{ V}$	$V_{i(off)}$	0.8	-	1.5	
Input on voltage $I_C = 2 \text{ mA}, V_{CE} = 0.3 \text{ V}$	$V_{i(on)}$	1	-	2.5	
Input resistor	R_1	7	10	13	k Ω
Resistor ratio	R_1/R_2	0.9	1	1.1	-
AC Characteristics					
Transition frequency $I_C = 10 \text{ mA}, V_{CE} = 5 \text{ V}, f = 100 \text{ MHz}$	f_T	-	130	-	MHz
Collector-base capacitance $V_{CB} = 10 \text{ V}, f = 1 \text{ MHz}$	C_{cb}	-	3	-	pF

¹Pulse test: $t < 300 \mu\text{s}$; $D < 2\%$

DC current gain $h_{FE} = f(I_C)$

$V_{CE} = 5\text{ V}$ (common emitter configuration)

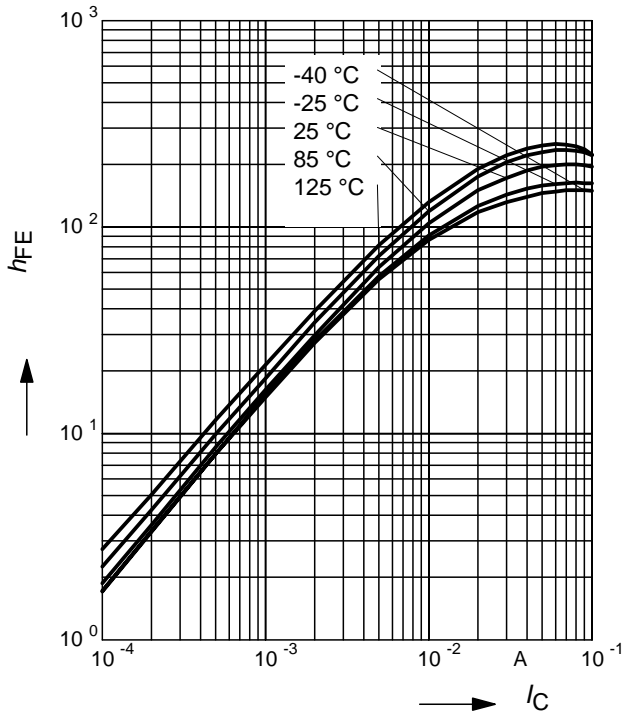

Collector-emitter saturation voltage

$V_{CEsat} = f(I_C), I_C/I_B = 20$

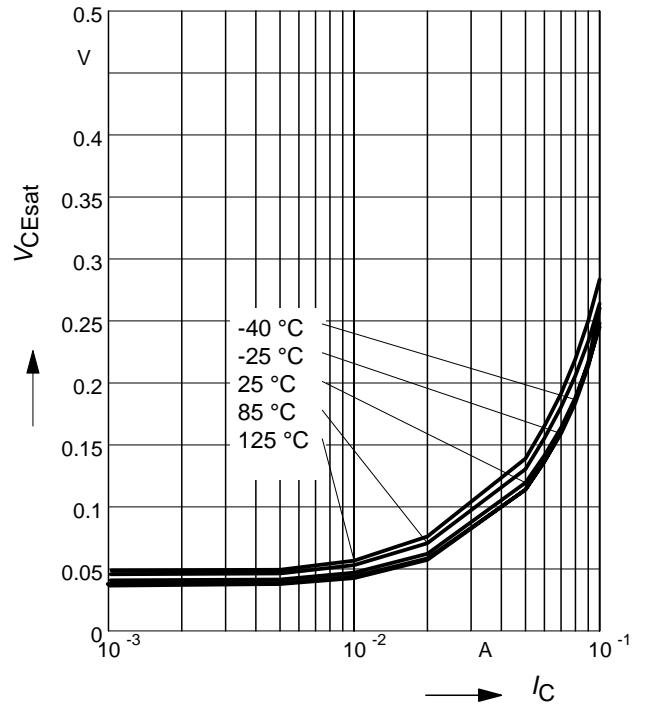

Input on Voltage $V_{i(on)} = f(I_C)$

$V_{CE} = 0.3\text{ V}$ (common emitter configuration)

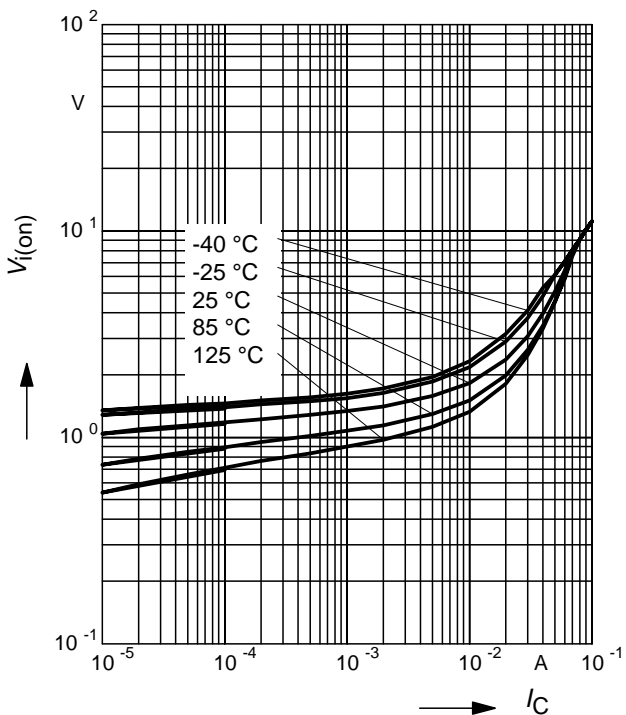

Input off voltage $V_{i(off)} = f(I_C)$

$V_{CE} = 5\text{ V}$ (common emitter configuration)

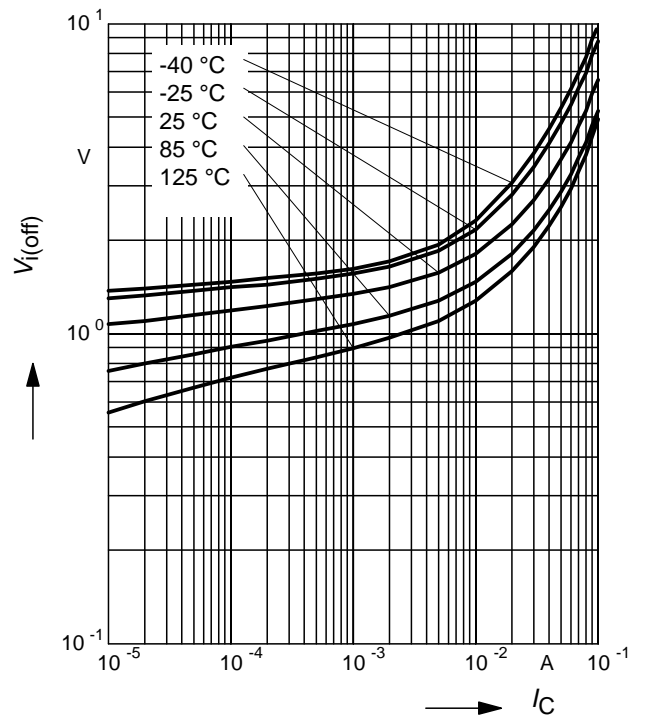

Total power dissipation $P_{tot} = f(T_S)$

BCR133

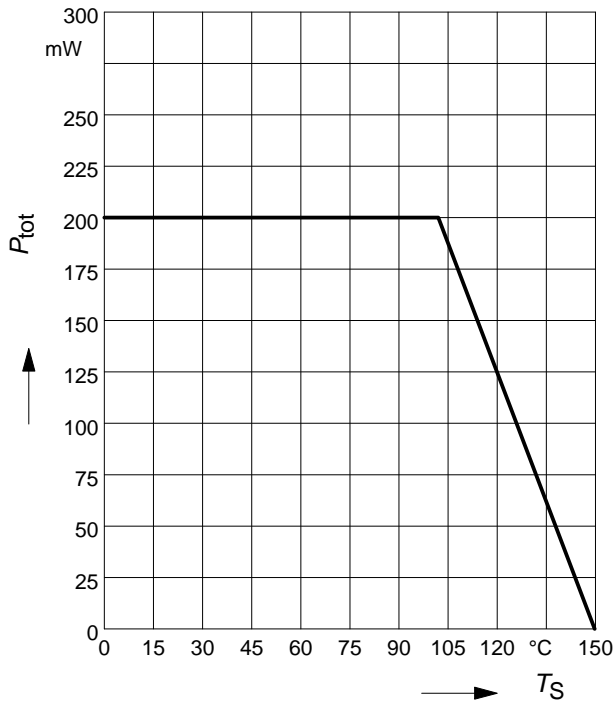

Total power dissipation $P_{tot} = f(T_S)$

BCR133F

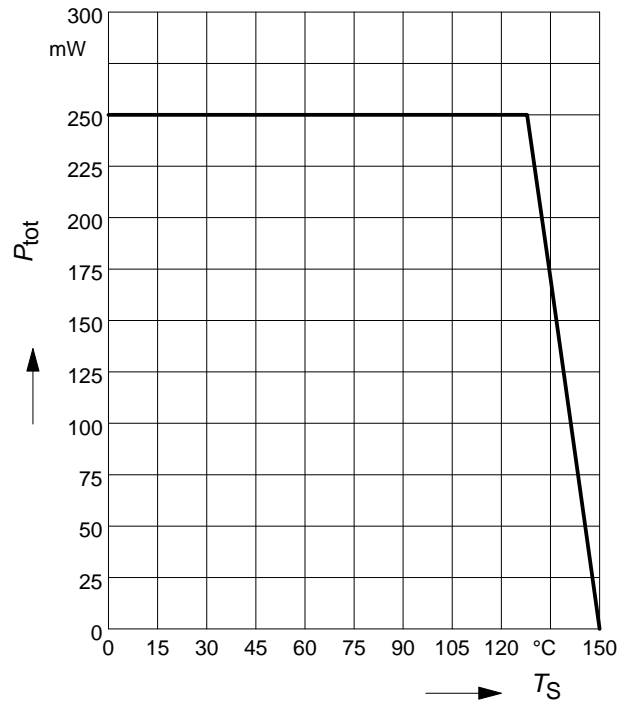

Total power dissipation $P_{tot} = f(T_S)$

BCR133S

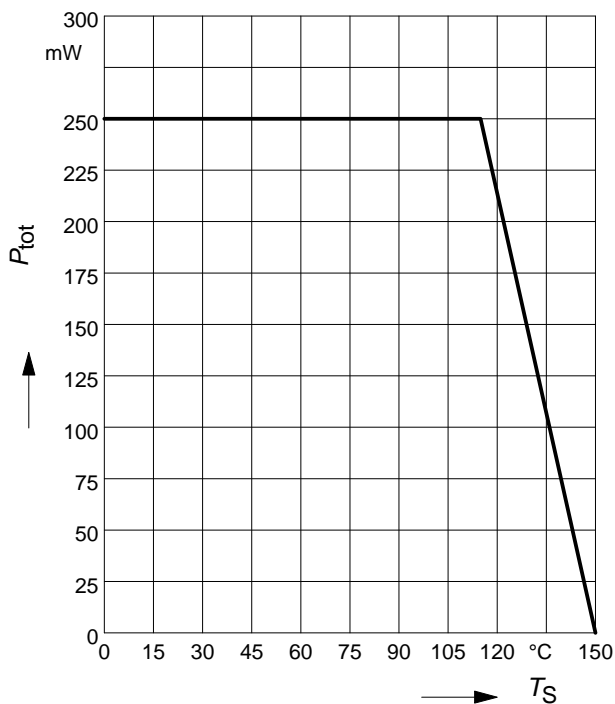

Total power dissipation $P_{tot} = f(T_S)$

BCR133W

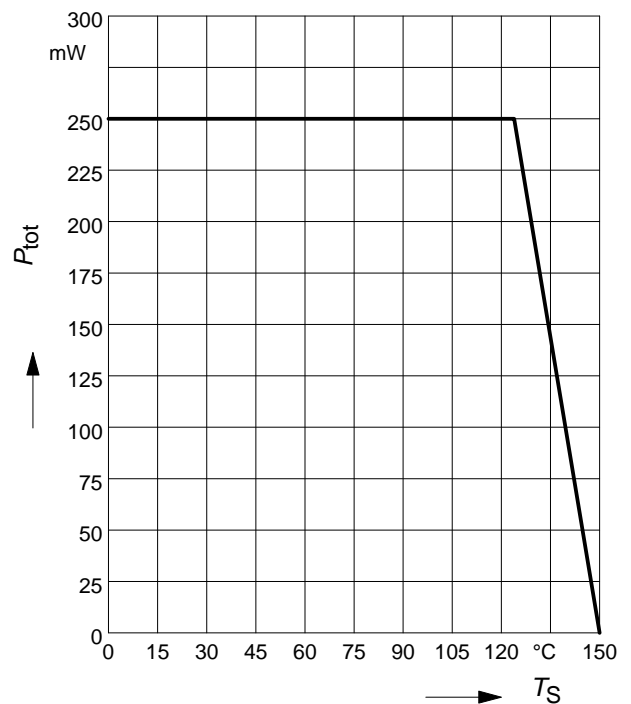

Permissible Pulse Load $R_{thJS} = f(t_p)$

BCR133

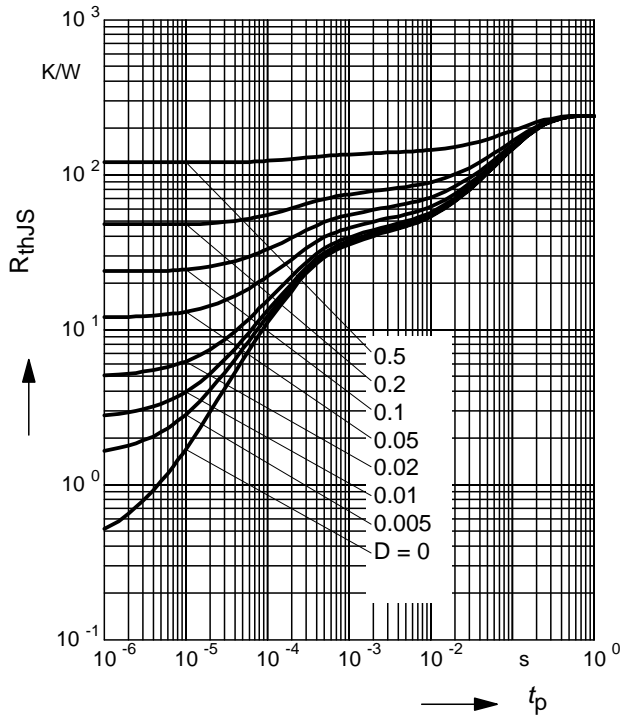

Permissible Pulse Load

$P_{totmax}/P_{totDC} = f(t_p)$

BCR133

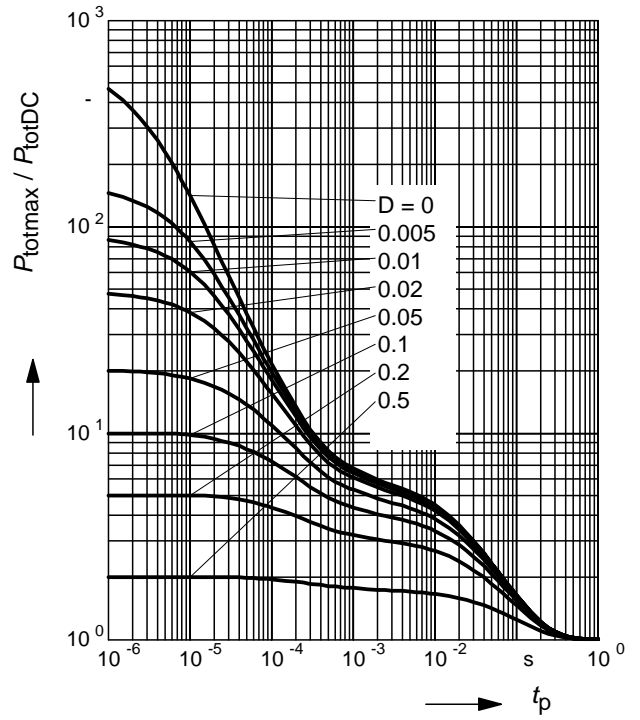

Permissible Puls Load $R_{thJS} = f(t_p)$

BCR133F

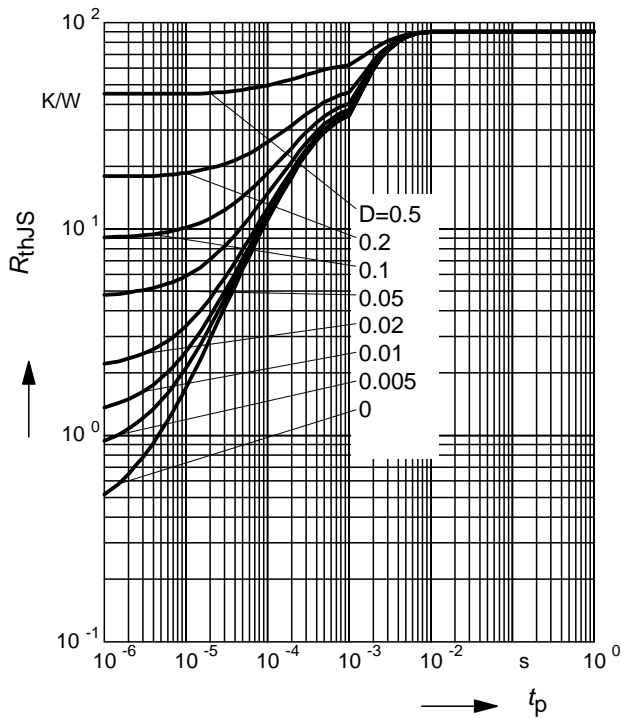

Permissible Pulse Load

$P_{totmax}/P_{totDC} = f(t_p)$

BCR133F

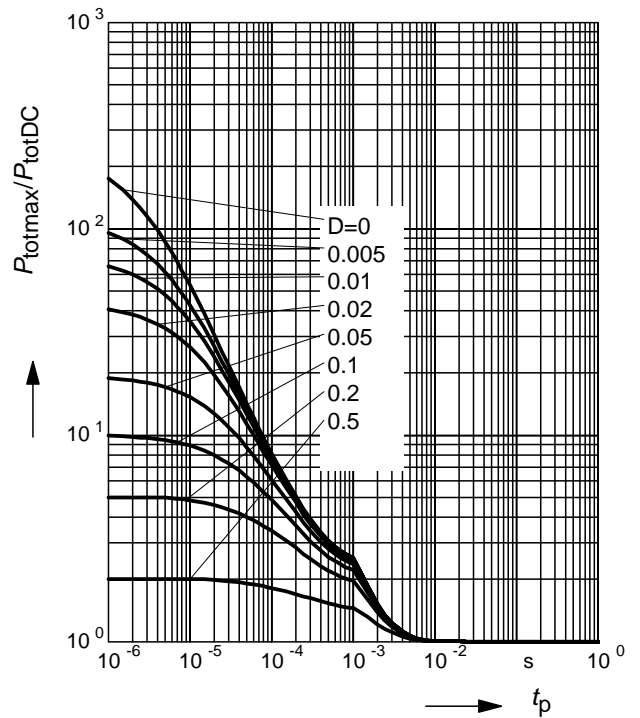

Permissible Puls Load $R_{thJS} = f(t_p)$

BCR133S

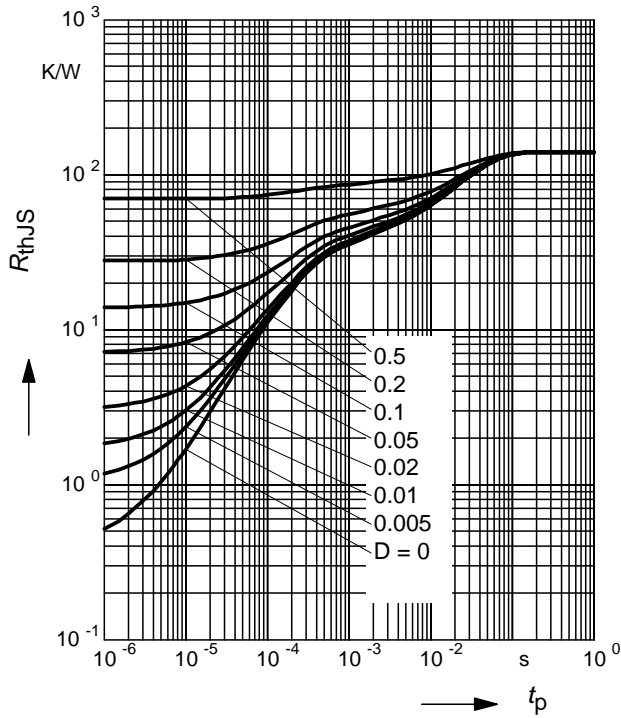

Permissible Pulse Load

$P_{totmax}/P_{totDC} = f(t_p)$

BCR133S

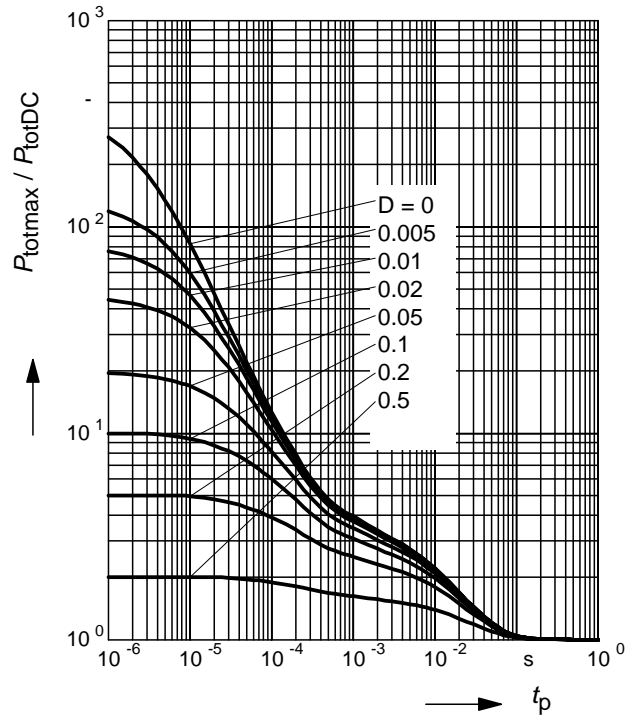

Permissible Puls Load $R_{thJS} = f(t_p)$

BCR133W

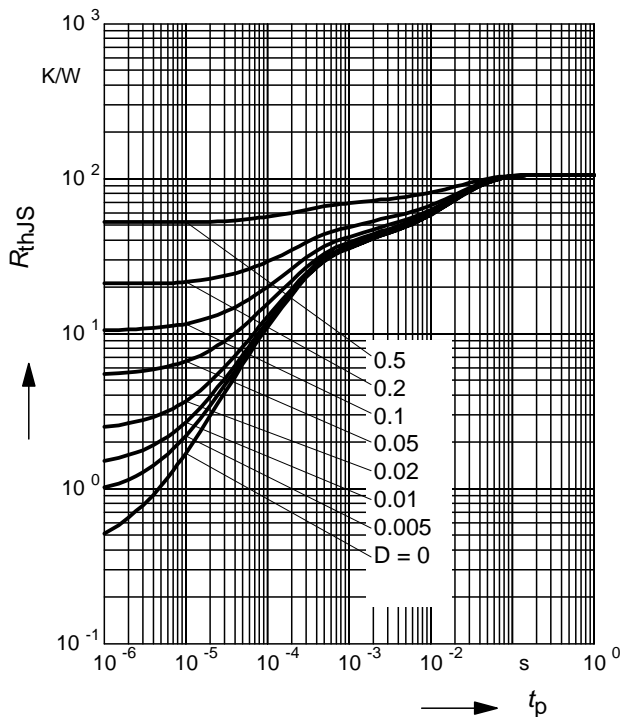

Permissible Pulse Load

$P_{totmax}/P_{totDC} = f(t_p)$

BCR133W

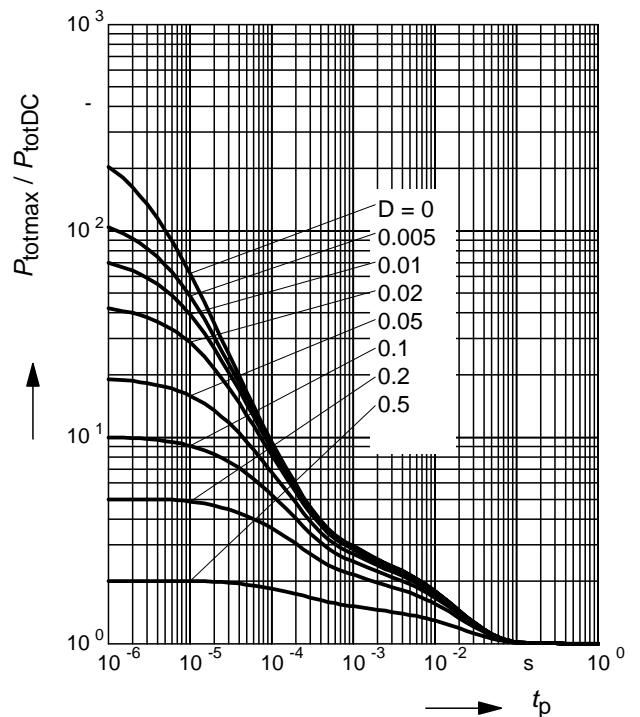

Package Outline

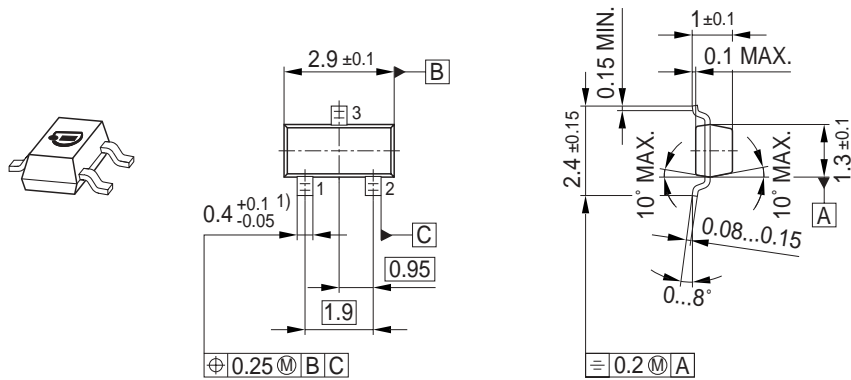

1) Lead width can be 0.6 max. in dambar area

Foot Print

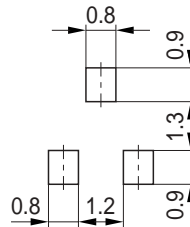

Marking Layout (Example)

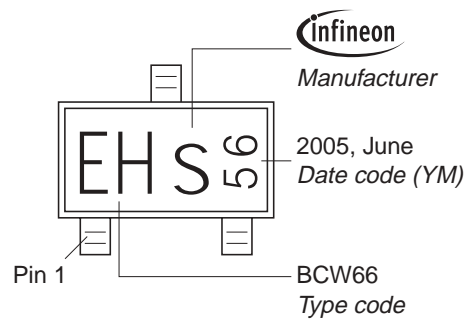

Standard Packing

Reel \varnothing 180 mm = 3.000 Pieces/Reel
 Reel \varnothing 330 mm = 10.000 Pieces/Reel

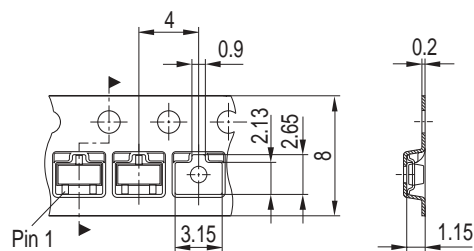

Package Outline

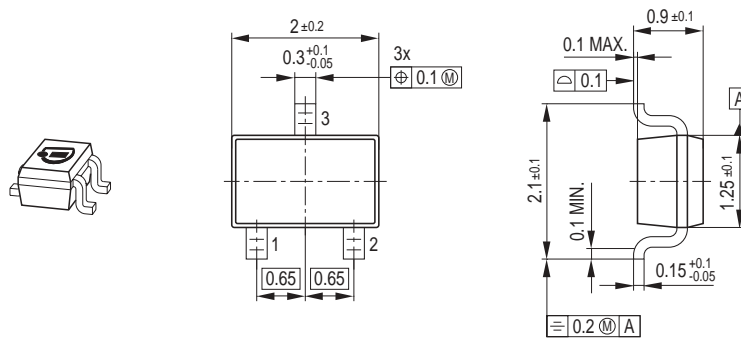

Foot Print

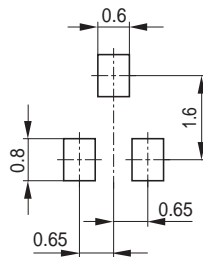

Marking Layout (Example)

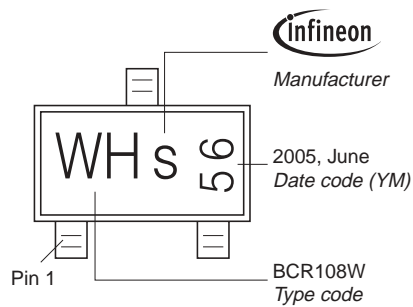

Standard Packing

Reel \varnothing 180 mm = 3.000 Pieces/Reel
 Reel \varnothing 330 mm = 10.000 Pieces/Reel

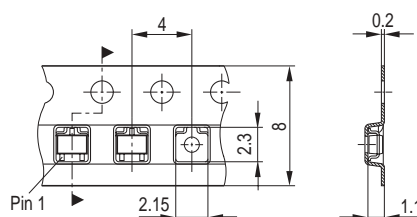

Package Outline

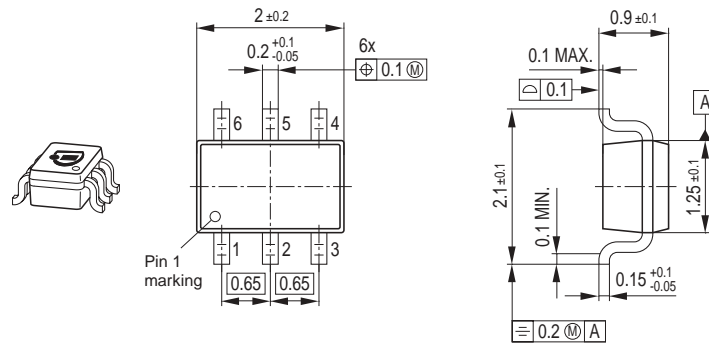

Foot Print

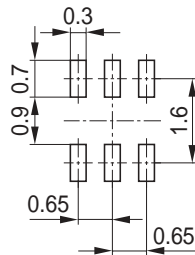

Marking Layout (Example)

Small variations in positioning of Date code, Type code and Manufacture are possible.

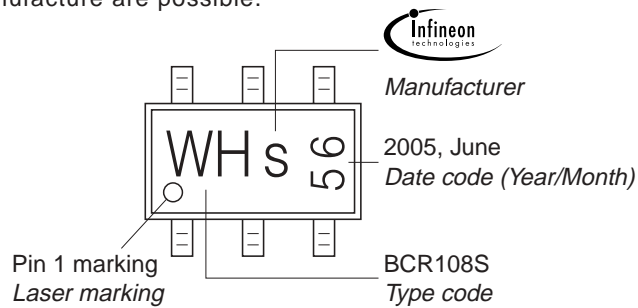

Standard Packing

Reel \varnothing 180 mm = 3.000 Pieces/Reel
 Reel \varnothing 330 mm = 10.000 Pieces/Reel

For symmetric types no defined Pin 1 orientation in reel.

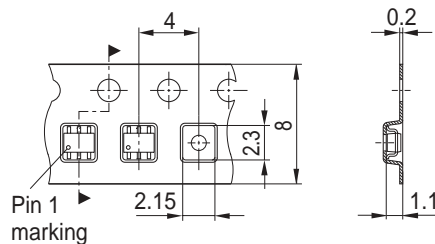

Edition 2006-02-01

Published by

Infineon Technologies AG

81726 München, Germany

© Infineon Technologies AG 2007.

All Rights Reserved.

Attention please!

The information given in this dokument shall in no event be regarded as a guarantee of conditions or characteristics ("Beschaffenheitsgarantie"). With respect to any examples or hints given herein, any typical values stated herein and/or any information regarding the application of the device, Infineon Technologies hereby disclaims any and all warranties and liabilities of any kind, including without limitation warranties of non-infringement of intellectual property rights of any third party.

Information

For further information on technology, delivery terms and conditions and prices please contact your nearest Infineon Technologies Office (www.infineon.com).

Warnings

Due to technical requirements components may contain dangerous substances. For information on the types in question please contact your nearest Infineon Technologies Office.

Infineon Technologies Components may only be used in life-support devices or systems with the express written approval of Infineon Technologies, if a failure of such components can reasonably be expected to cause the failure of that life-support device or system, or to affect the safety or effectiveness of that device or system.

Life support devices or systems are intended to be implanted in the human body, or to support and/or maintain and sustain and/or protect human life. If they fail, it is reasonable to assume that the health of the user or other persons may be endangered.



Компания «ЭлектроПласт» предлагает заключение долгосрочных отношений при поставках импортных электронных компонентов на взаимовыгодных условиях!

Наши преимущества:

- Оперативные поставки широкого спектра электронных компонентов отечественного и импортного производства напрямую от производителей и с крупнейших мировых складов;
- Поставка более 17-ти миллионов наименований электронных компонентов;
- Поставка сложных, дефицитных, либо снятых с производства позиций;
- Оперативные сроки поставки под заказ (от 5 рабочих дней);
- Экспресс доставка в любую точку России;
- Техническая поддержка проекта, помощь в подборе аналогов, поставка прототипов;
- Система менеджмента качества сертифицирована по Международному стандарту ISO 9001;
- Лицензия ФСБ на осуществление работ с использованием сведений, составляющих государственную тайну;
- Поставка специализированных компонентов (Xilinx, Altera, Analog Devices, Intersil, Interpoint, Microsemi, Aeroflex, Peregrine, Syfer, Eurofarad, Texas Instrument, Miteq, Cobham, E2V, MA-COM, Hittite, Mini-Circuits, General Dynamics и др.);

Помимо этого, одним из направлений компании «ЭлектроПласт» является направление «Источники питания». Мы предлагаем Вам помощь Конструкторского отдела:

- Подбор оптимального решения, техническое обоснование при выборе компонента;
- Подбор аналогов;
- Консультации по применению компонента;
- Поставка образцов и прототипов;
- Техническая поддержка проекта;
- Защита от снятия компонента с производства.



Как с нами связаться

Телефон: 8 (812) 309 58 32 (многоканальный)

Факс: 8 (812) 320-02-42

Электронная почта: org@eplast1.ru

Адрес: 198099, г. Санкт-Петербург, ул. Калинина, дом 2, корпус 4, литера А.