



FEATURES AND BENEFITS

2" x 4" x 1.25" Package, Ideal for 1U Applications

Designed to Meet New IEC 60601-1-2 4th Edition EMC Requirements

100 Watts Convection Cooled

Class B Conducted and Radiated EMI Performance

BF Isolation Type Rated

Class I and Class II Input Versions Available

10-Year Life Design with Premium E-Caps

2 x MOPP Isolation

<0.5 W Standby Power

3 Year Warranty

Certified to UL/CSA/ IEC/ EN60601-1 3rd Edition



MODEL SELECTION

Model Number ²	Volts	Output Current		Efficiency ⁴	Ripple & Noise ⁵	Initial Set Point	Total Load Regulation	OVP Threshold
		200 LFM Airflow	Convection					
MB120S12K01	12V	10.0A	8.3A	92%	1%	±2%	±1%	14.4V ±1.2V
MB120S15K01	15V	8.0A	6.6A	93%	1%	±2%	±1%	18V ±1.5V
MB120S18K01	18V	6.6A	5.5A	94%	1%	±2%	±1%	21.6V ±1.8V
MB120S24K01	24V	5.0A	4.1A	94%	1%	±2%	±1%	28.8V ±2.4V
MB120S12C01	12V	10.0A	8.3A	92%	1%	±2%	±1%	14.4V ±1.2V
MB120S15C01	15V	8.0A	6.6A	93%	1%	±2%	±1%	18V ±1.5V
MB120S18C01	18V	6.6A	5.5A	94%	1%	±2%	±1%	21.6V ±1.8V
MB120S24C01	24V	5.0A	4.1A	94%	1%	±2%	±1%	28.8V ±2.4V

Notes:

1. Power supply is tested according to Table 9–Test Specification for Enclosure Port Immunity for Professional and Home Health Care.
2. Replace the “K” in the part number to “C” for Class II input.
3. Efficiency, typical at 230VAC, 25°C. See charts below for load conditions.
4. Measured at 25°C using 6 inch twisted pair wires with noise probe directly across output terminals, and load terminated with 0.1µF ceramic and 10µF low ESR capacitors.



INPUT

AC Input	80VAC–264VAC, single phase, 47Hz–63Hz. (Safety Approved to 90VAC–264VAC). Start up voltage for full power is 90VAC, power derates at 85VAC, see table below.
Input Current	2.0A at 115VAC, 1A at 230VAC
Inrush Current	40 Arms Maximum within a half line cycle, cold start at 25°C, 230VAC. See application note.
Input Fuses	3.15A, 250VAC, line and neutral inputs
Earth Leakage Current	<150 μ A@264VAC, 60Hz input, NC <300 μ A@264VAC, 60Hz input, SFC
Patient Leakage Current (Output to Earth)	<90 μ A@264VAC, 60 Hz input, NC, also suitable for BF rating
Efficiency	92%–94% typical at 120VAC/240VAC, 25°C. See chart for additional details.
No Load Input Power	<0.5W

ISOLATION

Isolation	Input-Output: 4000VAC, 2 x MOPP Input-Ground: 1500VAC, 1 x MOPP (Class I only) Output-Ground: 1500VAC, 1 x MOPP (Class I only)
-----------	--

RELIABILITY

MTBF	572,500 hours @ 115VAC/230VAC, 25°C Telcordia, Issue 3, Ground Benign
E-Cap Life	>10 years in use condition of 40°C ambient, at 12 hours/day, 261 days/year. Additional information on other use profiles available on request.

PROTECTION

Overvoltage Protection	Latches off when output voltage is with range as shown in table. Requires AC Power cycle to reset.
Short Circuit Protection	Short across the output terminals will not cause damage to the unit. Hiccup Mode, Auto-recovery.
Overtemperature Protection	Power shuts down at temperature of 70°C (typical) at full load, without forced air. Hiccup Mode, Auto-recovery.
Overload Protection	115%–180% of rated output current value. Hiccup Mode, Auto-recovery.
Output Reverse Voltage Protection	Outputs protected against momentary reverse current less than 20A peak for less than 10mS with 0.5A average. Sustained reverse current at high levels may damage unit.

OUTPUT

Output Voltage	12V to 24VDC. See models chart for part numbering.
Output Power	120W with 200 LFM airflow cooling, 100W convection cooling, -10°C to 50°C ambient. Power derates by 50% from 50°C to 70°C. See chart below.
Turn On Time	1 second at 115VAC
Hold-up Time	20mS min. from loss of AC input, full load, 25°C
Rise Time	<30mS, Typical (Load dependent)
Ripple and Noise	1% pk-pk
Total Load Regulation	\pm 1.0% for all models
Minimum Load	Not required
Turn-On & Operating Temperature	-10°C to +70°C. Turn on Temperature = -20°C at \geq 115VAC, allowing 30 seconds with 50%–100% load for stabilization.
Transient Response	500 μ S typ. response time for return to within 1% of final value for 25%–75%–25% load change
Voltage Adjustment Range	No voltage adjust potentiometer for higher reliability
IPC 610	Class II

SAFETY

Safety Standards	IEC 60601-1 3 rd Edition ANSI/AAMI ES60601-1 (2008) CAN/CSA - C22.2 No 60601-1 (2005) DEMKO EN60601-1:2006 Designed to meet China Safety Doc. No. GB4943.1-2011 at 3Km, Tropical Standard at 40°C, 93% RH at 120 hours
------------------	---



ENVIRONMENT

Relative Humidity	5% to 95%, non-condensing
Weight	225g, typical
Dimensions	W: 2.0" x L: 4.0" x H: 1.25" W: 50.8mm x L: 101.6mm x H: 31.8mm
Altitude	Operating: -500m to 3000m Non-operating: -500 feet to 40,000 feet
Storage Temperature	-40°C to +85°C
Vibration	Operating: Sinusoidal Frequency: 10–500Hz, Impact Acceleration: 1g, Sweep rate: 1 octave/min Cycles: 10 times per axis in X, Y, Z direction Random Vibration: Operating: 0.003 g ² /Hz, 1.224 grams overall, 3 axes, 10 min/axis, 1Hz–500Hz. Non-Operating: 0.02g ² /Hz, 3.1 grams overall, 3 axes, 1 hour/axis, 20Hz–500Hz
Shock (IEC 60068-2-27)	Operating: Half-sine shock waveform. Impact Acceleration: 20g, Pulse duration: 11mS. Cycles: 3 times per axis in X,Y, Z direction Non-Operating: Half-sine shock waveform. Impact Acceleration: 40g, Pulse duration: 6mS Cycles: 3 times per direction on 3 axes (X,Y, Z)

Notes:

Performance criteria are based on EN55024. According to the standards, performance criteria are defined as following:

- A – Normal performance during and after the test
- B – Temporary degradation, self-recoverable
- C – Temporary degradation, operator intervention required to recover the operation
- D – Permanent damage

EMI/EMC COMPLIANCE

Conducted Emissions	EN55011/22: Class B, FCC Part 15. Class B: 6db margin typical
Radiated Emissions	EN55011/22: Class B, FCC Part 15. Class B: 3db margin typical
Harmonic Current Emissions	IEC61000-3-2: Class A
Voltage Fluctuations & Flicker	IEC 61000-3-3
Electro Static Discharge Immunity	IEC61000-4-2: Level 4, 8kV Contact Discharge, 15kV air discharge, Criteria A. Also meets proposed IEC60601-1-2 4 th Edition, Table 9
Radiated RF EM Fields Susceptibility	IEC61000-4-3: Level 3, 10V/m, Criteria A. 80MHz-1000MHz and 3V/m 1.4Ghz to 2.7GHz. 80% AM at 1kHz. Also meets proposed IEC60601-1-2 4 th Edition, Table 9
Proximity Fields from RF wireless communications Equipment	IEC60601-1-2 4 th Edition, Table 9
Rated Power Frequency magnetic fields	IEC61000-4-8 Level 5, 30A/m, 50/60Hz
Electrical Fast Transients / Bursts	IEC61000-4-4: Level 3, 2KV, 100Khz rep rate, 40A (PS Output), Criteria A Also meets proposed IEC60601-1-2 4 th Edition standard, Table 5 & 6.
Surges Line to Line (DM) and Line to Ground (CM)	IEC61000-4-5: Level 3, +/-1kV DM, +/-2kV CM, Criteria A Also meets proposed IEC60601-1-2 4 th Edition standard, Table 5.
Conducted Disturbances induced by RF Fields	IEC61000-4-6: 3V/m– 0.15 to 80Mhz and 6V/m in ISM bands between 0.15MHz and 80 MHz. 80% AM at 1KHz.
Rated Power Frequency Magnetic Fields Test	IEC61000-4-8: Level 4 (30A/m), Criteria A Also meets proposed IEC60601-1-2 4 th Edition standard, Table 9 enclosure port.
Voltage Dips	IEC61000-4-11: 100% dip for 10mS, at 0°, 45°, 90°, 135°, 180°, 225°, 270° and 315°, Criteria A; 60% dip for 100mS, Criteria B; 30% dip for 500mS (25/30 cycles) 1Ø, and 0° for 500mS, Criteria A. Also meets proposed IEC60601-1-2 4 th Edition standard, Table 5.
Enclosure Port Immunity to RF wireless communications equipment	IEC61000-4-3



MECHANICAL DRAWING

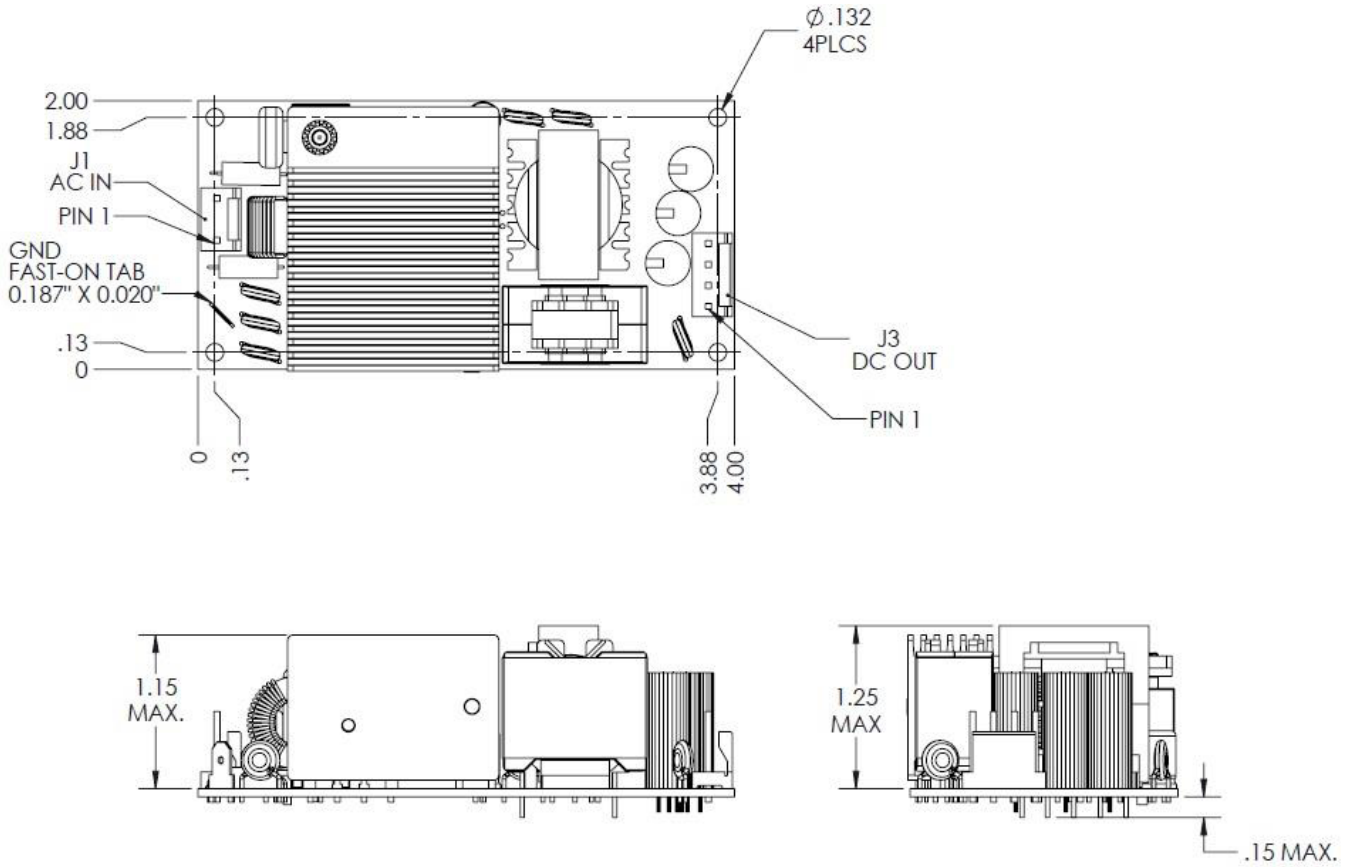

DERATING CURVES

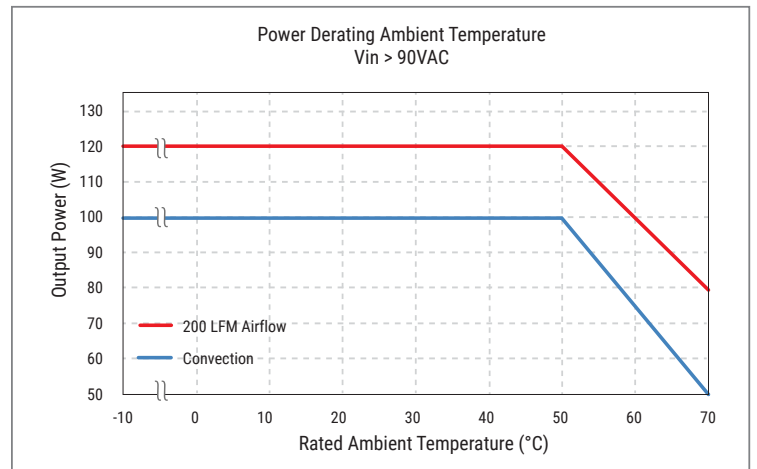
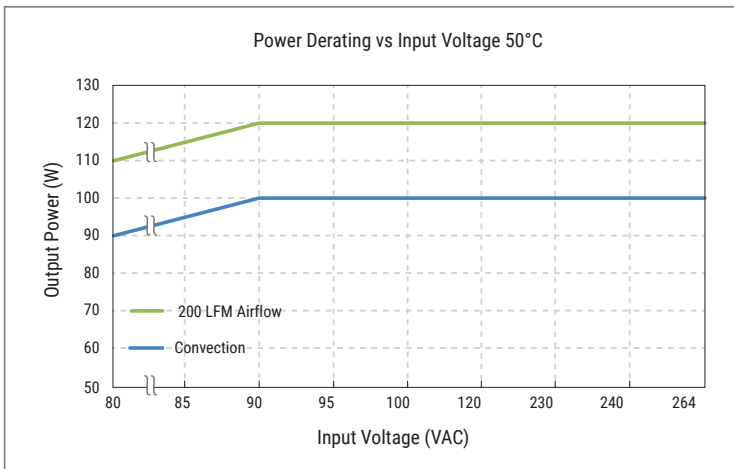



EFFICIENCY INFORMATION

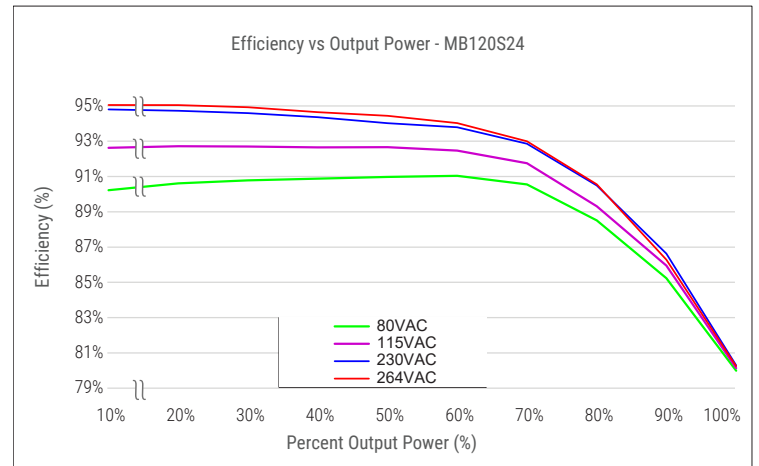
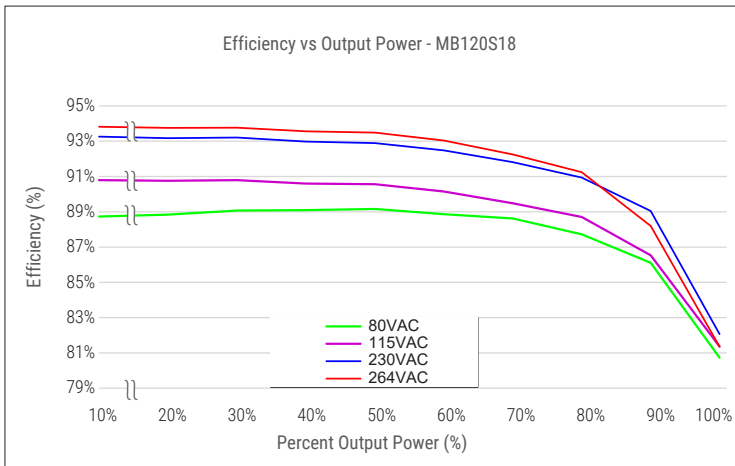
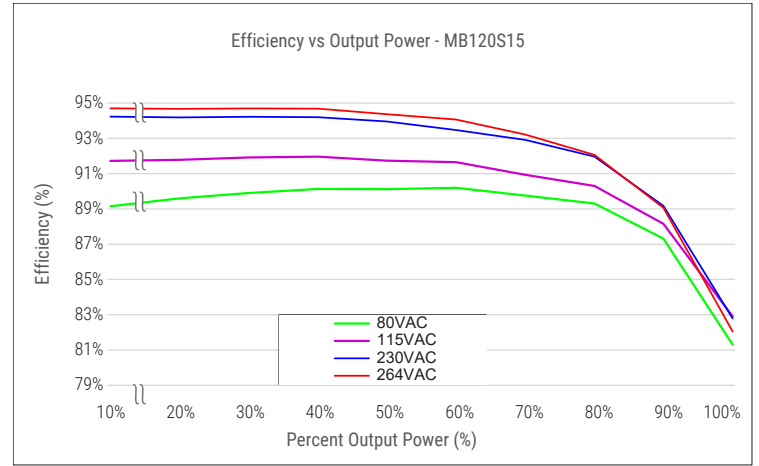
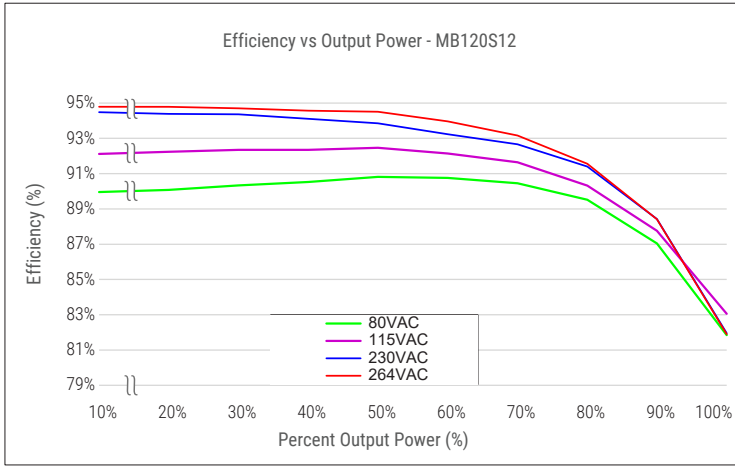

Notes:
Above efficiency curves are typical at 25°C convection cooling, after 1 hour warm up time. Efficiency may vary with lower run time prior to measurement.

CONNECTOR INFORMATION

	CONN	PIN#	ASSIGNMENT	CONNECTOR	MATING CONNECTOR	MATING PIN
INPUT	J1	1	LINE	TE-CONNECTIVITY 641937-1	TE CONNECTIVITY 640250-3	TE CONNECTIVITY 640252-2
		2	NEUTRAL			
OUTPUT	J3	1	DC OUTPUT RETURN	TE-CONNECTIVITY 640445-4	TE CONNECTIVITY 640250-4	TE CONNECTIVITY 640252-2
		2				
		3	DC OUTPUT			
		4				



Компания «ЭлектроПласт» предлагает заключение долгосрочных отношений при поставках импортных электронных компонентов на взаимовыгодных условиях!

Наши преимущества:

- Оперативные поставки широкого спектра электронных компонентов отечественного и импортного производства напрямую от производителей и с крупнейших мировых складов;
- Поставка более 17-ти миллионов наименований электронных компонентов;
- Поставка сложных, дефицитных, либо снятых с производства позиций;
- Оперативные сроки поставки под заказ (от 5 рабочих дней);
- Экспресс доставка в любую точку России;
- Техническая поддержка проекта, помощь в подборе аналогов, поставка прототипов;
- Система менеджмента качества сертифицирована по Международному стандарту ISO 9001;
- Лицензия ФСБ на осуществление работ с использованием сведений, составляющих государственную тайну;
- Поставка специализированных компонентов (Xilinx, Altera, Analog Devices, Intersil, Interpoint, Microsemi, Aeroflex, Peregrine, Syfer, Eurofarad, Texas Instrument, Miteq, Cobham, E2V, MA-COM, Hittite, Mini-Circuits, General Dynamics и др.);

Помимо этого, одним из направлений компании «ЭлектроПласт» является направление «Источники питания». Мы предлагаем Вам помощь Конструкторского отдела:

- Подбор оптимального решения, техническое обоснование при выборе компонента;
- Подбор аналогов;
- Консультации по применению компонента;
- Поставка образцов и прототипов;
- Техническая поддержка проекта;
- Защита от снятия компонента с производства.



Как с нами связаться

Телефон: 8 (812) 309 58 32 (многоканальный)

Факс: 8 (812) 320-02-42

Электронная почта: org@eplast1.ru

Адрес: 198099, г. Санкт-Петербург, ул. Калинина, дом 2, корпус 4, литера А.