



RoHS compliant

### 3. High sensitivity

Using the same type of high-performance polar magnetic circuits as DS relays, by matching the spring load to the magnetic force of attraction, greater sensitivity has been achieved. The resultant pick up sensitivity of about 190 mW makes possible direct driving of transistors and chips.

### 4. High breakdown voltage

Breakdown voltage has been raised by keeping the coil and contacts separate.

Between contact and coil	Between contacts
3,000 Vrms for 1 min. 5,000 V surge breakdown voltage	1,000 Vrms for 1 min. 1,500 V surge breakdown voltage

Conforms with FCC Part 68

### 5. Latching types available

### 6. Wide variation

Three types of contact arrangement are offered: 1a, 2a, and 1a1b. In addition, each is available in standard and reversed polarity types.

### 7. Sealed construction allows automatic washing.

### 8. Complies with safety standards

Complies with Japan Electrical Appliance and Material Safety Law requirements for operating 200 V power supply circuits, and complies with UL, CSA, and TÜV safety standards.

### 9. Sockets are available.

## TYPICAL APPLICATIONS

- Office and industrial electronic devices
- Terminal devices of information processing equipment, such as printer, data recorder.
- Office equipment (copier, facsimile)
- Measuring instruments
- NC machines, temperature controllers and programmable logic controllers.

## FEATURES

### 1. Compact with high contact rating

Even with small 10 mm .394 inch (H) x 11 mm .433 inch (W) x 20 mm .787 inch (L) (dimensions, high capacity switching is provided: 1a, 8 A 250 V AC; 2a and 1a1b, 5 A 250 V AC).

### 2. High switching capability

High contact pressure, low contact bounce, and wiping operation improve resistance to weld bonding. Resistant against lamp load and dielectric loading: 1a achieves maximum switching capacity of 2,000 VA (8A 250 V AC).

## ORDERING INFORMATION

DSP  -  -  -  -

Contact arrangement

- 1a: 1 Form A
- 1: 1 Form A 1 Form B
- 2a: 2 Form A

Operating function

- Nil: Single side stable
- L2: 2 coil latching

Nominal coil voltage

- DC 3, 5, 6, 9, 12, 24 V

Polarity

- Nil: Standard polarity
- R: Reverse polarity

Contact material

- AgSnO<sub>2</sub> type
- F: 1 Form A 1 Form B
- Nil: 1 Form A, 2 Form A

- Notes: 1. Reverse polarity types available (add suffix-R)  
2. Certified by UL, CSA and TÜV

## TYPES

Contact arrangement	Nominal coil voltage	Single side stable	2 coil latching
		Part No.	Part No.
1 Form A	3V DC	DSP1a-DC3V	DSP1a-L2-DC3V
	5V DC	DSP1a-DC5V	DSP1a-L2-DC5V
	6V DC	DSP1a-DC6V	DSP1a-L2-DC6V
	9V DC	DSP1a-DC9V	DSP1a-L2-DC9V
	12V DC	DSP1a-DC12V	DSP1a-L2-DC12V
	24V DC	DSP1a-DC24V	DSP1a-L2-DC24V
1 Form A 1 Form B	3V DC	DSP1-DC3V-F	DSP1-L2-DC3V-F
	5V DC	DSP1-DC5V-F	DSP1-L2-DC5V-F
	6V DC	DSP1-DC6V-F	DSP1-L2-DC6V-F
	9V DC	DSP1-DC9V-F	DSP1-L2-DC9V-F
	12V DC	DSP1-DC12V-F	DSP1-L2-DC12V-F
	24V DC	DSP1-DC24V-F	DSP1-L2-DC24V-F
2 Form A	3V DC	DSP2a-DC3V	DSP2a-L2-DC3V
	5V DC	DSP2a-DC5V	DSP2a-L2-DC5V
	6V DC	DSP2a-DC6V	DSP2a-L2-DC6V
	9V DC	DSP2a-DC9V	DSP2a-L2-DC9V
	12V DC	DSP2a-DC12V	DSP2a-L2-DC12V
	24V DC	DSP2a-DC24V	DSP2a-L2-DC24V

Standard packing: Carton: 50 pcs.; Case: 500 pcs.

Note: Reverse polarity type are manufactured by lot upon receipt of order. Self-clinching types are also available, please consult us.

\* For sockets, see page 100.

## RATING

### 1. Coil data

#### 1) Single side stable

Nominal coil voltage	Pick-up voltage (at 20°C 68°F)	Drop-out voltage (at 20°C 68°F)	Nominal operating current [±10%] (at 20°C 68°F)	Coil resistance [±10%] (at 20°C 68°F)	Nominal operating power	Max. applied voltage (at 20°C 68°F)
3V DC	80%V or less of nominal voltage (Initial)	10%V or more of nominal voltage (Initial)	100mA	30Ω	300mW	130%V of nominal voltage
5V DC			60mA	83Ω		
6V DC			50mA	120Ω		
9V DC			33.3mA	270Ω		
12V DC			25mA	480Ω		
24V DC			12.5mA	1,920Ω		

#### 2) 2 coil latching

Nominal coil voltage	Set voltage (at 20°C 68°F)	Reset voltage (at 20°C 68°F)	Nominal operating current [±10%] (at 20°C 68°F)		Coil resistance [±10%] (at 20°C 68°F)		Nominal operating power		Max. applied voltage (at 20°C 68°F)
			Set coil	Reset coil	Set coil	Reset coil	Set coil	Reset coil	
3V DC	80%V or less of nominal voltage (Initial)	80%V or less of nominal voltage (Initial)	100mA	100mA	30Ω	30Ω	300mW	300mW	130%V of nominal voltage
5V DC			60mA	60mA	83Ω	83Ω			
6V DC			50mA	50mA	120Ω	120Ω			
9V DC			33.3mA	33.3mA	270Ω	270Ω			
12V DC			25mA	25mA	480Ω	480Ω			
24V DC			12.5mA	12.5mA	1,920Ω	1,920Ω			

# DSP

## 2. Specifications

Characteristics	Item	Specifications			
		1 Form A	1 Form A 1 Form B	2 Form A	
Contact	Arrangement	1 Form A			
	Contact resistance (Initial)	Max. 30 mΩ (By voltage drop 6 V DC 1A)			
	Contact material	Au-flashed AgSnO <sub>2</sub> type			
Rating	Nominal switching capacity (resistive load)	8 A 250 V AC, 5 A 30V DC	5 A 250 V AC, 5 A 30 V DC		
	Max. switching power (resistive load)	2,000 VA, 150 W	1,250 VA, 150 W		
	Max. switching voltage	250 V AC, 125 V DC			
	Max. switching current	8 A AC, 5 A DC	5 A AC, DC		
	Nominal operating power	300 mW			
	Min. switching capacity (Reference value)*1	10m A 5 V DC			
Electrical characteristics	Insulation resistance (Initial)	Min. 1,000MΩ (at 500V DC) Measurement at same location as "Breakdown voltage" section.			
	Breakdown voltage (Initial)	Between open contacts	1,000 Vrms for 1min. (Detection current: 10mA.)		
		Between contact sets	2,000 Vrms (1 Form A 1 Form B, 2 Form A) (Detection current: 10mA.)		
		Between contact and coil	3,000 Vrms for 1min. (Detection current: 10mA.)		
	Surge breakdown voltage*2	between contacts and coil	5,000 V		
	Temperature rise (coil) (at 65°C 149°F)		Max. 55°C	Max. 40°C	Max. 55°C
	Operate time [Set time] (at 20°C 68°F)		Max. 10 ms [10 ms] (Nominal coil voltage applied to the coil, excluding contact bounce time.)		
Release time [Reset time] (at 20°C 68°F)		Max. 5 ms [10 ms] (Nominal coil voltage applied to the coil, excluding contact bounce time.) (without diode)			
Mechanical characteristics	Shock resistance	Functional	Min. 196 m/s <sup>2</sup> (Half-wave pulse of sine wave: 11 ms; detection time: 10μs.)		
		Destructive	Min. 980 m/s <sup>2</sup> (Half-wave pulse of sine wave: 6 ms.)		
	Vibration resistance	Functional	10 to 55 Hz at double amplitude of 2 mm (Detection time: 10μs.)		
		Destructive	10 to 55 Hz at double amplitude of 3.5 mm		
Expected life	Mechanical	Min. 5×10 <sup>7</sup> (at 180 times/min.)			
	Electrical	Min. 10 <sup>5</sup> (resistive load)			
Conditions	Conditions for operation, transport and storage*3 (Not freezing and condensing at low temperature)	Ambient temperature: -40°C to +60°C -40°F to +140°F	Ambient temperature: -40°C to +65°C -40°F to +149°F	Ambient temperature: -40°C to +60°C -40°F to +140°F	
	Solder heating	250°C 482°F (10s), 300°C 572°F (5s), 350°C 662°F (3s) (Soldering depth: 2/3 terminal pitch)			
	Max. operating speed	3 cps			
Unit weight		Approx. 4.5 g .16 oz			

Notes: \*1. This value can change due to the switching frequency, environmental conditions, and desired reliability level, therefore it is recommended to check this with the actual load.

\*2. Wave is standard shock voltage of  $\pm 1.2 \times 50\mu\text{s}$  according to JEC-212-1981

\*3. The upper limit of the ambient temperature is the maximum temperature that can satisfy the coil temperature rise value. Refer to Usage, transport and storage conditions in NOTES.

## REFERENCE DATA

### 1. Max. switching capacity

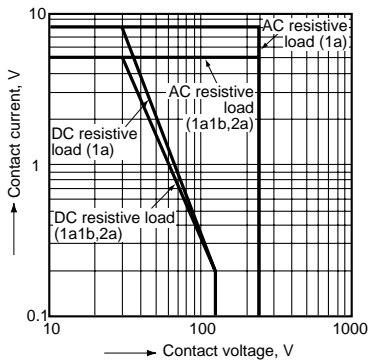

### 2.-(1) Life curve (1 Form A 1 Form B)

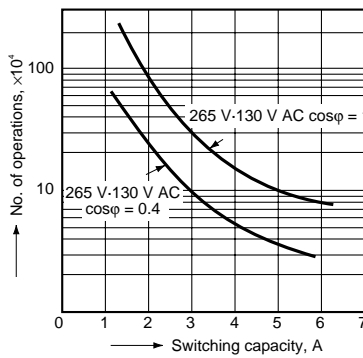

### 2.-(2) Life curve (1 Form A 1 Form B)

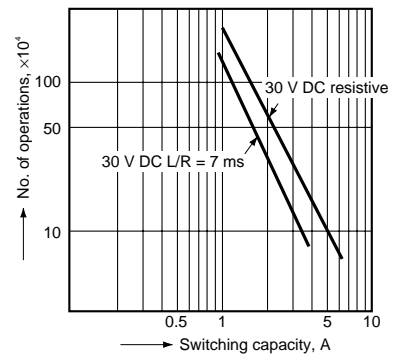

### 3.-(1) Coil temperature rise (1 Form A)

Tested sample: DSP1a-DC12V, 5 pcs.

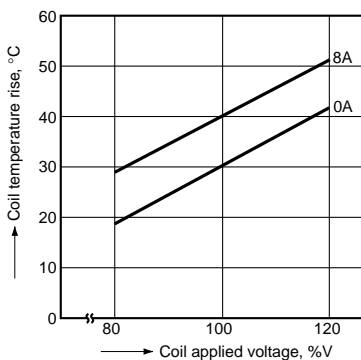

### 3.-(2) Coil temperature rise (1 Form A 1 Form B)

Tested sample: DSP1-DC12V, 5 pcs.

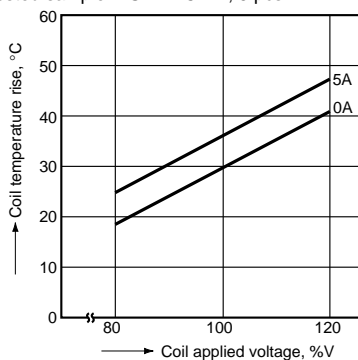

### 3.-(3) Coil temperature rise (2 Form A)

Tested sample: DSP2a-DC12V, 5 pcs.

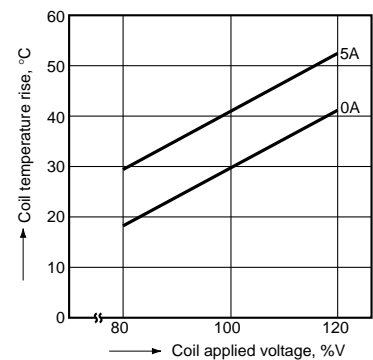

4.-(1) Operate & release time  
(without diode, 1 Form A)

Tested sample: DSP1a-DC12V, 5 pcs.

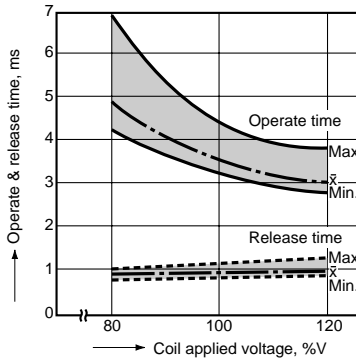

4.-(2) Operate & release time  
(without diode, 1 Form A 1 Form B)

Tested sample: DSP1-DC12V, 5 pcs.

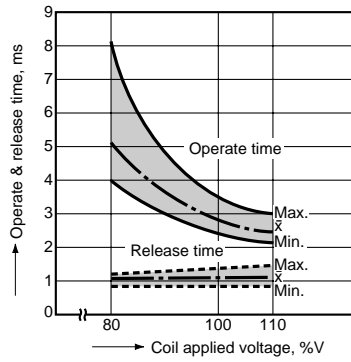

4.-(3) Operate & release time  
(without diode, 2 Form A)

Tested sample: DSP2a-DC12V, 5 pcs.

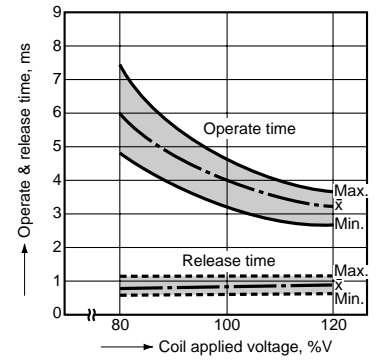

4.-(4) Operate & release time  
(with diode, 1 Form A)

Tested sample: DSP1a-DC12V, 5 pcs.

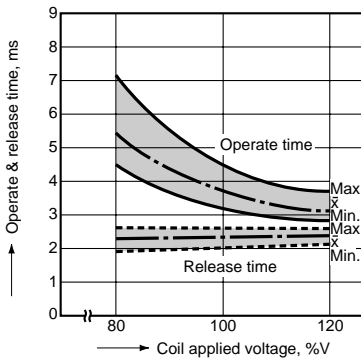

4.-(5) Operate & release time  
(with diode, 1 Form A 1 Form B)

Tested sample: DSP1-DC12V, 5 pcs.

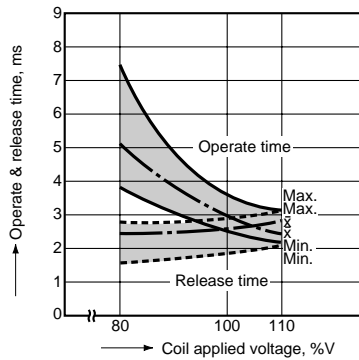

4.-(6) Operate & release time  
(with diode, 2 Form A)

Tested sample: DSP2a-DC12V, 5 pcs.

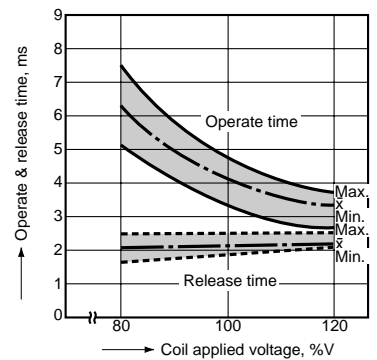

5.-(1) Change of pick-up and drop-out voltage  
(1 Form A)

Tested sample: DSP1a-DC12V, 5 pcs.

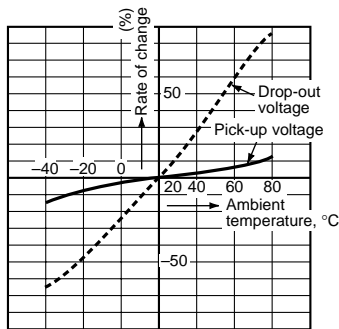

5.-(2) Change of pick-up and drop-out voltage  
(1 Form A 1 Form B)

Tested sample: DSP1-DC12V, 5 pcs.

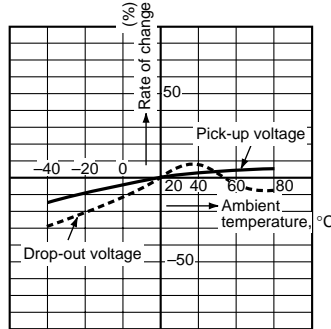

5.-(3) Change of pick-up and drop-out voltage  
(2 Form A)

Tested sample: DSP2a-DC12V, 5 pcs.

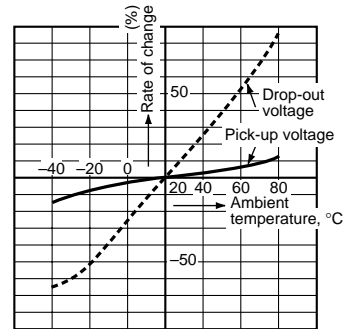

6.-(1) Influence of adjacent mounting  
(1 Form A)

Tested sample: DSP1a-DC12V, 5 pcs.

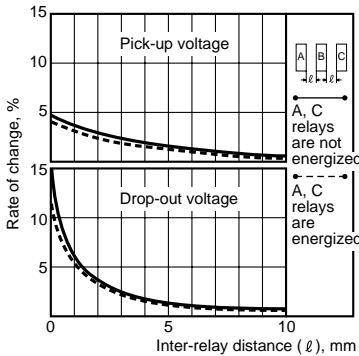

6.-(2) Influence of adjacent mounting  
(1 Form A 1 Form B)

Tested sample: DSP1-DC12V, 5 pcs.

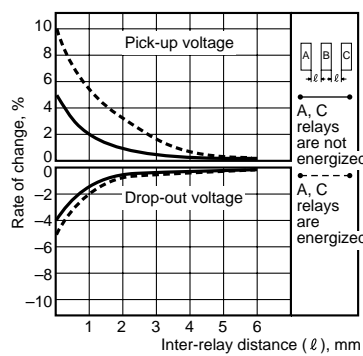

6.-(3) Influence of adjacent mounting  
(2 Form A)

Tested sample: DSP2a-DC12V, 5 pcs.

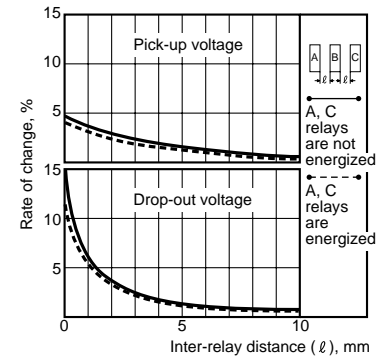

# DSP

## DIMENSIONS (mm inch)

The CAD data of the products with a **CAD Data** mark can be downloaded from: <http://industrial.panasonic.com/ac/e/>

### 1. 1 Form A type

**CAD Data**

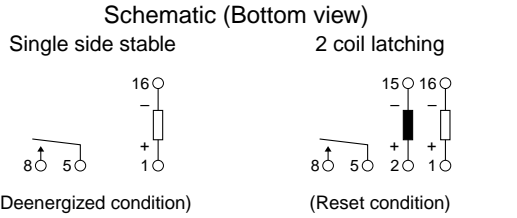
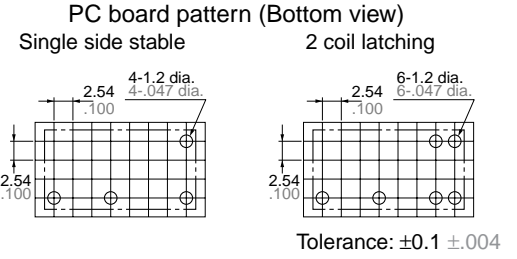
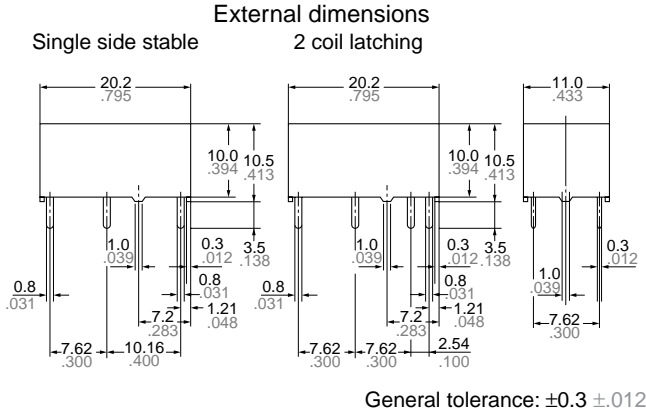

### 2. 1 Form A 1 Form B type

**CAD Data**

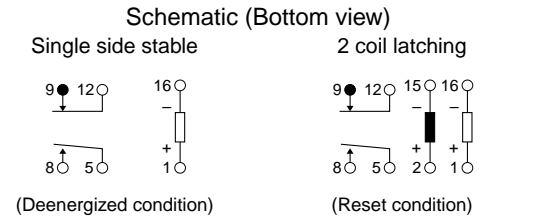
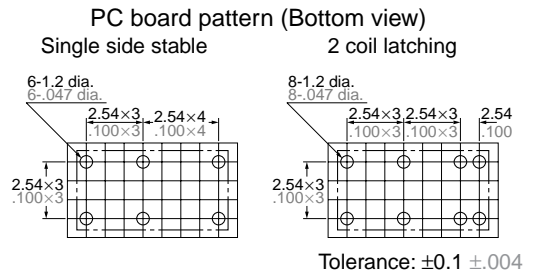
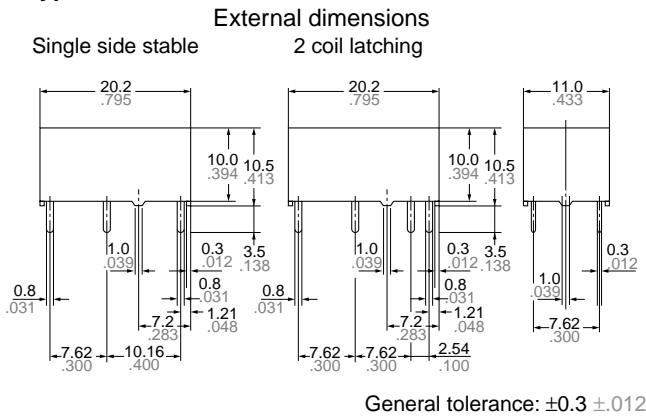

### 3. 2 Form A type

**CAD Data**

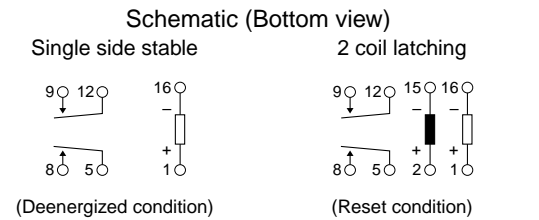
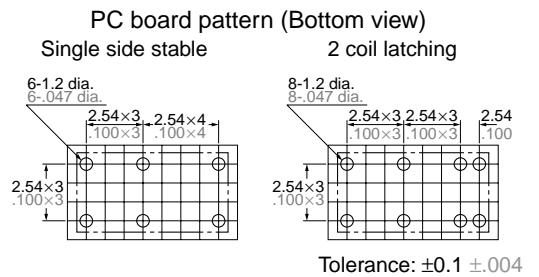
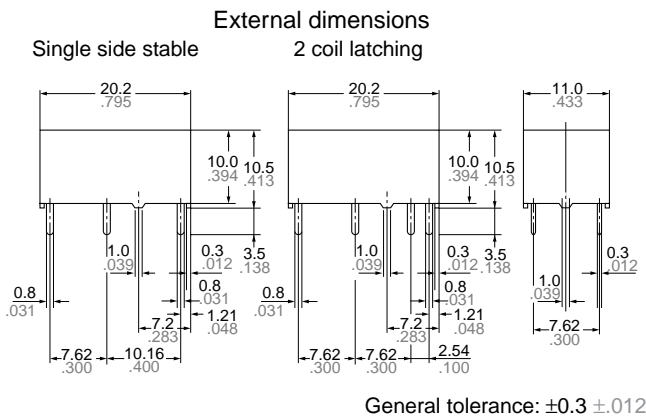

## SAFETY STANDARDS

Item	UL/C-UL (Recognized)		CSA (Certified)		TÜV (Certified)	
	File No.	Contact rating	File No.	Contact rating	File No.	Rating
1 Form A	E43028	8A 250V AC 1/6HP 125, 250V AC 5A 30V DC	LR26550 etc.	8A 250V AC 1/6HP 125, 250V AC 5A 30V DC	B 02 10 13461 238	8A 250V AC (cosφ=1.0) 5A 250V AC (cosφ=0.4) 5A 30V DC
1 Form A 1 Form B	E43028	5A 250V AC 1/6HP 125, 250V AC 5A 30V DC	LR26550 etc.	5A 250V AC 1/6HP 125, 250V AC 5A 30V DC	B 02 10 13461 238	5A 250V AC (cosφ=1.0) 3A 250V AC (cosφ=0.4) 5A 30V DC
2 Form A	E43028	5A 250V AC 1/10HP 125, 250V AC 5A 30V DC	LR26550 etc.	5A 250V AC 1/10HP 125, 250V AC 5A 30V DC	B 02 10 13461 238	5A 250V AC (cosφ=1.0) 3A 250V AC (cosφ=0.4) 5A 30V DC

\* Remarks: The standard certified for may differ depending on where the product was manufactured.

## NOTES

### 1. Soldering conditions

Please obey the following conditions when soldering automatically.

- 1) Preheating: Within 120°C 248°F and within 120 seconds
- 2) Soldering iron: 260°C±5°C 500°F±41°F and within 6 seconds

### 2. Cleaning

For automatic cleaning, the boiling method is recommended. Avoid ultrasonic cleaning which subjects the relays to high frequency vibrations, which may cause the contacts to stick. It is recommended that a fluorinated hydrocarbon or other alcoholic solvents be used.

### 3. External magnetic field

Since DY relays are highly sensitive polarized relays, their characteristics will be affected by a strong external magnetic field. Avoid using the relay under that condition.

### 4. Coil operating power

Pure DC current should be applied to the coil. The wave form should be rectangular. If it includes ripple, the ripple factor should be less than 5%. However, check it with the actual circuit since the characteristics may be slightly different.

**5. When using, please be aware that the a contact and b contact sides of 1 Form A and 1 Form B types may go on simultaneously at operate time and release time.**

## For Cautions for Use.

# Mouser Electronics

Authorized Distributor

Click to View Pricing, Inventory, Delivery & Lifecycle Information:

## Panasonic:

[DSP2A-DC12V](#) [DSP2A-DC24V](#) [DSP1A-DC5V](#) [DSP2A-DC5V](#) [DSP2A-L2-DC5V](#) [DSP2A-L2-DC12V](#) [DSP1A-L2-DC5V](#) [DSP1A-DC12V](#) [DSP1A-DC24V](#) [DSP1A-PS](#) [DSP2A-PS](#) [DSP2A-PSL2](#) [DSP1-L2-DC12V-F](#) [DSP1-DC24V-F](#) [DSP1-DC6V-F](#) [DSP2A-L2-DC24V](#) [DSP1-L2-DC5V-F](#) [DSP1A-L2-DC12V](#) [DSP1-L2-DC24V-F](#) [DSP1-DC12V-F](#) [DSP1-DC5V-F](#) [DSP1A-DC9V](#) [DSP1A-L2-DC24V](#) [DSP1a-DC3V](#) [DSP1a-DC6V](#) [DSP1a-L2-DC3V](#) [DSP1a-L2-DC6V](#) [DSP1a-L2-DC9V](#) [DSP1-DC3V-F](#) [DSP1-DC9V-F](#) [DSP1-L2-DC3V-F](#) [DSP1-L2-DC6V-F](#) [DSP1-L2-DC9V-F](#) [DSP2a-DC3V](#) [DSP2a-DC6V](#) [DSP2a-DC9V](#) [DSP2a-L2-DC3V](#) [DSP2a-L2-DC6V](#) [DSP2a-L2-DC9V](#) [DSP1A-DC12V-R](#) [DSP1A-DC24V-F](#) [DSP1A-DC24V-R](#) [DSP1A-DC5V-R](#) [DSP1A-DC6V-R](#) [DSP1A-L2-DC12V-R](#) [DSP1A-L2-DC24V-R](#) [DSP1A-L2-DC3V-TUV](#) [DSP1A-L2-DC5V-R](#) [DSP1A-L-DC12V](#) [DSP1A-L-DC24V](#) [DSP1A-L-DC24V-R](#) [DSP1A-L-DC3V](#) [DSP1A-L-DC5V](#) [DSP1A-L-DC5V-Y1](#) [DSP1A-L-DC6V](#) [DSP1A-PSL2](#) [DSP1-DC1.5V](#) [DSP1-DC24V-R-F](#) [DSP1-DC5V-R](#) [DSP1-DC5V-R-F](#) [DSP1-DC6V-R](#) [DSP1-DC9V-R](#) [DSP1-L2-DC12V-R](#) [DSP1-L2-DC12V-R-F](#) [DSP1-L2-DC48V](#) [DSP1-L-DC12V](#) [DSP1-L-DC24V](#) [DSP1-L-DC3V](#) [DSP1-L-DC48V](#) [DSP1-L-DC5V](#) [DSP1-L-DC6V](#) [DSP1-L-DC9V](#) [DSP2A-DC12V-R](#) [DSP2A-DC24V-R](#) [DSP2A-DC5V-R](#) [DSP2A-DC6V-R](#) [DSP2A-L2-DC3V-TUV](#) [DSP2A-L-DC12V](#) [DSP2A-L-DC24V](#) [DSP2A-L-DC3V](#) [DSP2A-L-DC5V](#) [DSP2A-L-DC6V](#) [DSP2A-L-DC9V](#)



Компания «ЭлектроПласт» предлагает заключение долгосрочных отношений при поставках импортных электронных компонентов на взаимовыгодных условиях!

Наши преимущества:

- Оперативные поставки широкого спектра электронных компонентов отечественного и импортного производства напрямую от производителей и с крупнейших мировых складов;
- Поставка более 17-ти миллионов наименований электронных компонентов;
- Поставка сложных, дефицитных, либо снятых с производства позиций;
- Оперативные сроки поставки под заказ (от 5 рабочих дней);
- Экспресс доставка в любую точку России;
- Техническая поддержка проекта, помощь в подборе аналогов, поставка прототипов;
- Система менеджмента качества сертифицирована по Международному стандарту ISO 9001;
- Лицензия ФСБ на осуществление работ с использованием сведений, составляющих государственную тайну;
- Поставка специализированных компонентов (Xilinx, Altera, Analog Devices, Intersil, Interpoint, Microsemi, Aeroflex, Peregrine, Syfer, Eurofarad, Texas Instrument, Miteq, Cobham, E2V, MA-COM, Hittite, Mini-Circuits, General Dynamics и др.);

Помимо этого, одним из направлений компании «ЭлектроПласт» является направление «Источники питания». Мы предлагаем Вам помощь Конструкторского отдела:

- Подбор оптимального решения, техническое обоснование при выборе компонента;
- Подбор аналогов;
- Консультации по применению компонента;
- Поставка образцов и прототипов;
- Техническая поддержка проекта;
- Защита от снятия компонента с производства.



#### Как с нами связаться

**Телефон:** 8 (812) 309 58 32 (многоканальный)

**Факс:** 8 (812) 320-02-42

**Электронная почта:** [org@eplast1.ru](mailto:org@eplast1.ru)

**Адрес:** 198099, г. Санкт-Петербург, ул. Калинина, дом 2, корпус 4, литера А.