

# NSI45030AT1G

## Constant Current Regulator & LED Driver

45 V, 30 mA ± 10%, 460 mW Package

The linear constant current regulator (CCR) is a simple, economical and robust device designed to provide a cost-effective solution for regulating current in LEDs. The CCR is based on patent-pending Self-Biased Transistor (SBT) technology and regulates current over a wide voltage range. It is designed with a negative temperature coefficient to protect LEDs from thermal runaway at extreme voltages and currents.

The CCR turns on immediately and is at 25% of regulation with only 0.5 V  $V_{AK}$ . It requires no external components allowing it to be designed as a high or low-side regulator. The high anode-cathode voltage rating withstands surges common in Automotive, Industrial and Commercial Signage applications. The CCR comes in thermally robust packages and is qualified to AEC-Q101 standard.

### Features

- Robust Power Package: 460 mW
- Wide Operating Voltage Range
- Immediate Turn-On
- Voltage Surge Suppressing – Protecting LEDs
- AEC-Q101 Qualified
- SBT (Self-Biased Transistor) Technology
- Negative Temperature Coefficient
- These Devices are Pb-Free, Halogen Free/BFR Free and are RoHS Compliant

### Applications

- Automobile: Chevron Side Mirror Markers, Cluster, Display & Instrument Backlighting, CHMSL, Map Light
- AC Lighting Panels, Display Signage, Decorative Lighting, Channel Lettering
- Switch Contact Wetting
- Application Note AND8391/D – Power Dissipation Considerations
- Application Note AND8349/D – Automotive CHMSL

### MAXIMUM RATINGS ( $T_A = 25^\circ\text{C}$ unless otherwise noted)

Rating	Symbol	Value	Unit
Anode-Cathode Voltage	$V_{AK\text{ Max}}$	45	V
Reverse Voltage	$V_R$	500	mV
Operating and Storage Junction Temperature Range	$T_J, T_{stg}$	-55 to +150	$^\circ\text{C}$
ESD Rating: Human Body Model Machine Model	ESD	Class 1C Class B	

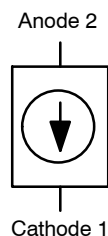
Stresses exceeding Maximum Ratings may damage the device. Maximum Ratings are stress ratings only. Functional operation above the Recommended Operating Conditions is not implied. Extended exposure to stresses above the Recommended Operating Conditions may affect device reliability.



ON Semiconductor®

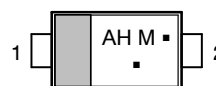
<http://onsemi.com>

$I_{reg(SS)} = 30\text{ mA}$   
@  $V_{AK} = 7.5\text{ V}$



SOD-123  
CASE 425  
STYLE 1

### MARKING DIAGRAM



AH = Device Code  
M = Date Code  
▪ = Pb-Free Package

(Note: Microdot may be in either location)

### ORDERING INFORMATION

Device	Package	Shipping†
NSI45030AT1G	SOD-123 (Pb-Free)	3000/Tape & Reel

†For information on tape and reel specifications, including part orientation and tape sizes, please refer to our Tape and Reel Packaging Specifications Brochure, BRD8011/D.

# NSI45030AT1G

## ELECTRICAL CHARACTERISTICS ( $T_A = 25^\circ\text{C}$ unless otherwise noted)

Characteristic	Symbol	Min	Typ	Max	Unit
Steady State Current @ $V_{AK} = 7.5\text{ V}$ (Note 1)	$I_{reg(SS)}$	27	30	33	mA
Voltage Overhead (Note 2)	$V_{overhead}$		1.8		V
Pulse Current @ $V_{AK} = 7.5\text{ V}$ (Note 3)	$I_{reg(P)}$	32.4	36.4	40.4	mA
Capacitance @ $V_{AK} = 7.5\text{ V}$ (Note 4)	C		2.5		pF
Capacitance @ $V_{AK} = 0\text{ V}$ (Note 4)	C		5.7		pF

- $I_{reg(SS)}$  steady state is the voltage ( $V_{AK}$ ) applied for a time duration  $\geq 10$  sec, using FR-4 @ 300 mm<sup>2</sup> 1 oz. Copper traces, in still air.
- $V_{overhead} = V_{in} - V_{LEDs}$ .  $V_{overhead}$  is typical value for 75%  $I_{reg(SS)}$ .
- $I_{reg(P)}$  non-repetitive pulse test. Pulse width  $t \leq 300\text{ }\mu\text{sec}$ .
- $f = 1\text{ MHz}$ ,  $0.02\text{ V RMS}$ .

## THERMAL CHARACTERISTICS

Characteristic	Symbol	Max	Unit
Total Device Dissipation (Note 5) $T_A = 25^\circ\text{C}$ Derate above $25^\circ\text{C}$	$P_D$	208 1.66	mW mW/ $^\circ\text{C}$
Thermal Resistance, Junction-to-Ambient (Note 5)	$R_{\theta JA}$	600	$^\circ\text{C/W}$
Thermal Reference, Lead-to-Ambient (Note 5)	$R_{\psi LA}$	404	$^\circ\text{C/W}$
Thermal Reference, Junction-to-Cathode Lead (Note 5)	$R_{\psi JL}$	196	$^\circ\text{C/W}$
Total Device Dissipation (Note 6) $T_A = 25^\circ\text{C}$ Derate above $25^\circ\text{C}$	$P_D$	227 1.8	mW mW/ $^\circ\text{C}$
Thermal Resistance, Junction-to-Ambient (Note 6)	$R_{\theta JA}$	550	$^\circ\text{C/W}$
Thermal Reference, Lead-to-Ambient (Note 6)	$R_{\psi LA}$	390	$^\circ\text{C/W}$
Thermal Reference, Junction-to-Cathode Lead (Note 6)	$R_{\psi JL}$	160	$^\circ\text{C/W}$
Total Device Dissipation (Note 7) $T_A = 25^\circ\text{C}$ Derate above $25^\circ\text{C}$	$P_D$	347 2.8	mW mW/ $^\circ\text{C}$
Thermal Resistance, Junction-to-Ambient (Note 7)	$R_{\theta JA}$	360	$^\circ\text{C/W}$
Thermal Reference, Lead-to-Ambient (Note 7)	$R_{\psi LA}$	200	$^\circ\text{C/W}$
Thermal Reference, Junction-to-Cathode Lead (Note 7)	$R_{\psi JL}$	160	$^\circ\text{C/W}$
Total Device Dissipation (Note 8) $T_A = 25^\circ\text{C}$ Derate above $25^\circ\text{C}$	$P_D$	368 2.9	mW mW/ $^\circ\text{C}$
Thermal Resistance, Junction-to-Ambient (Note 8)	$R_{\theta JA}$	340	$^\circ\text{C/W}$
Thermal Reference, Lead-to-Ambient (Note 8)	$R_{\psi LA}$	208	$^\circ\text{C/W}$
Thermal Reference, Junction-to-Cathode Lead (Note 8)	$R_{\psi JL}$	132	$^\circ\text{C/W}$
Total Device Dissipation (Note 9) $T_A = 25^\circ\text{C}$ Derate above $25^\circ\text{C}$	$P_D$	436 3.5	mW mW/ $^\circ\text{C}$
Thermal Resistance, Junction-to-Ambient (Note 9)	$R_{\theta JA}$	287	$^\circ\text{C/W}$
Thermal Reference, Lead-to-Ambient (Note 9)	$R_{\psi LA}$	139	$^\circ\text{C/W}$
Thermal Reference, Junction-to-Cathode Lead (Note 9)	$R_{\psi JL}$	148	$^\circ\text{C/W}$
Total Device Dissipation (Note 10) $T_A = 25^\circ\text{C}$ Derate above $25^\circ\text{C}$	$P_D$	463 3.7	mW mW/ $^\circ\text{C}$
Thermal Resistance, Junction-to-Ambient (Note 10)	$R_{\theta JA}$	270	$^\circ\text{C/W}$
Thermal Reference, Lead-to-Ambient (Note 10)	$R_{\psi LA}$	150	$^\circ\text{C/W}$
Thermal Reference, Junction-to-Cathode Lead (Note 10)	$R_{\psi JL}$	120	$^\circ\text{C/W}$
Junction and Storage Temperature Range	$T_J, T_{stg}$	-55 to +150	$^\circ\text{C}$

- FR-4 @ 100 mm<sup>2</sup>, 1 oz. copper traces, still air.
- FR-4 @ 100 mm<sup>2</sup>, 2 oz. copper traces, still air.
- FR-4 @ 300 mm<sup>2</sup>, 1 oz. copper traces, still air.
- FR-4 @ 300 mm<sup>2</sup>, 2 oz. copper traces, still air.
- FR-4 @ 500 mm<sup>2</sup>, 1 oz. copper traces, still air.
- FR-4 @ 500 mm<sup>2</sup>, 2 oz. copper traces, still air.

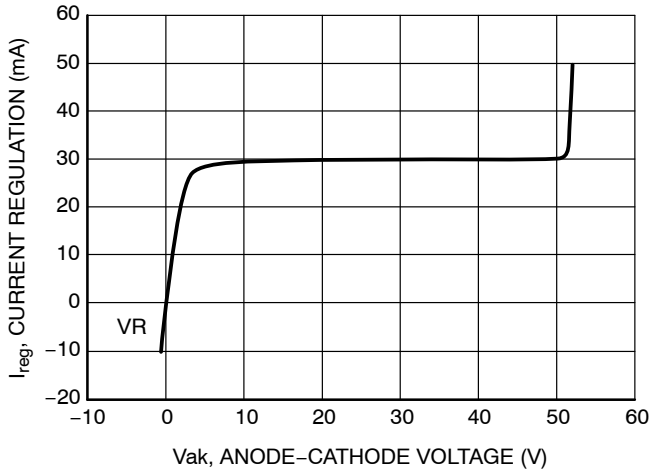
NOTE: Lead measurements are made by non-contact methods such as IR with treated surface to increase emissivity to 0.9.

Lead temperature measurement by attaching a T/C may yield values as high as 30% higher  $^\circ\text{C/W}$  values based upon empirical measurements and method of attachment.

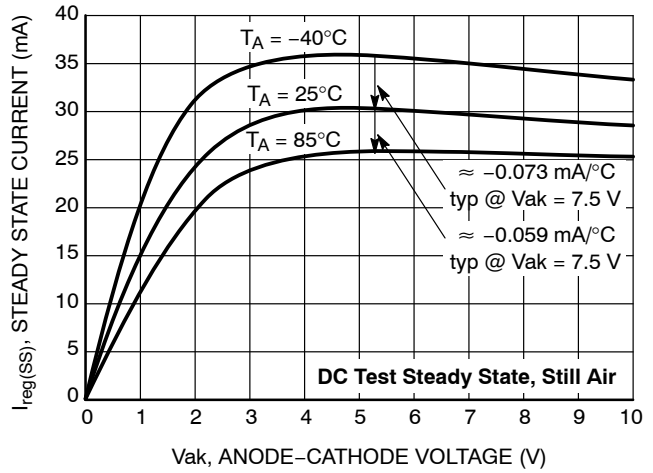
# NSI45030AT1G

## TYPICAL PERFORMANCE CURVES

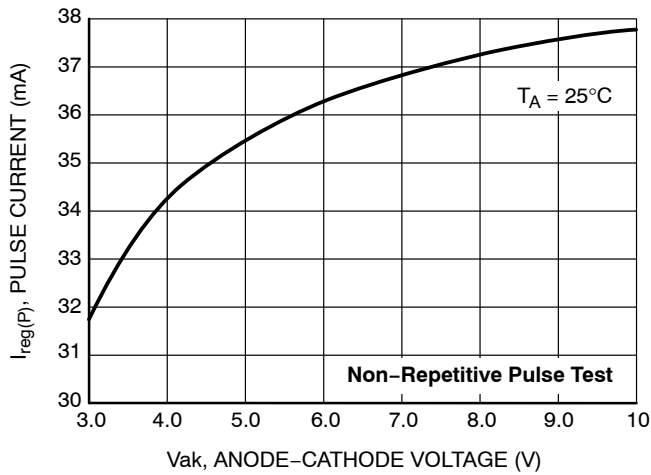
Minimum FR-4 @ 300 mm<sup>2</sup> 1 oz Copper Trace, Still Air



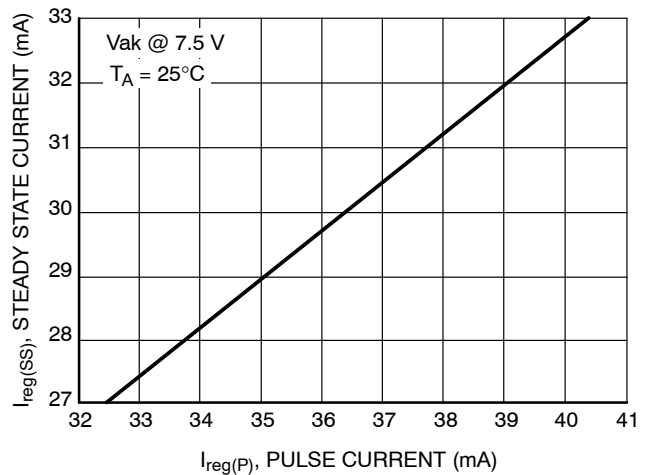
**Figure 1. General Performance Curve for CCR**



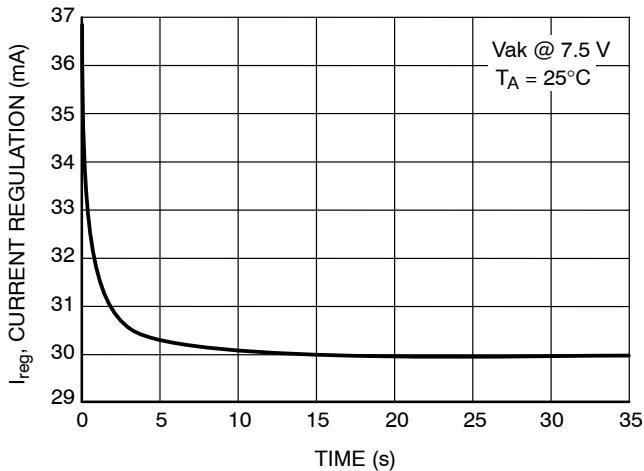
**Figure 2. Steady State Current ( $I_{reg(SS)}$ ) vs. Anode-Cathode Voltage ( $V_{ak}$ )**



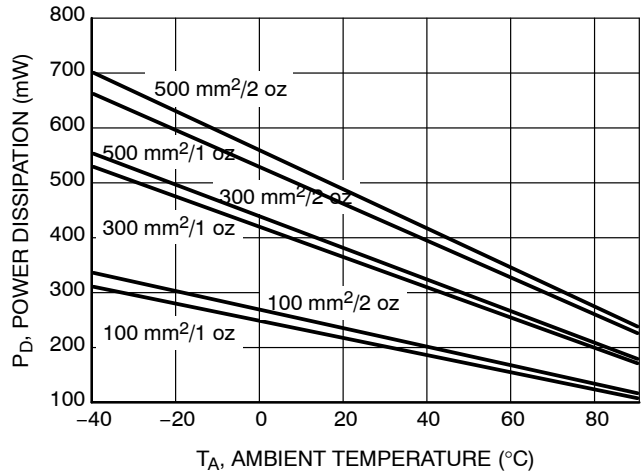
**Figure 3. Pulse Current ( $I_{reg(P)}$ ) vs. Anode-Cathode Voltage ( $V_{ak}$ )**



**Figure 4. Steady State Current vs. Pulse Current Testing**

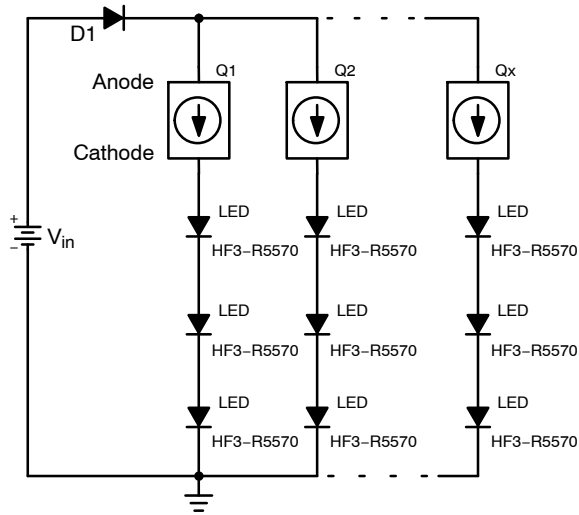


**Figure 5. Current Regulation vs. Time**



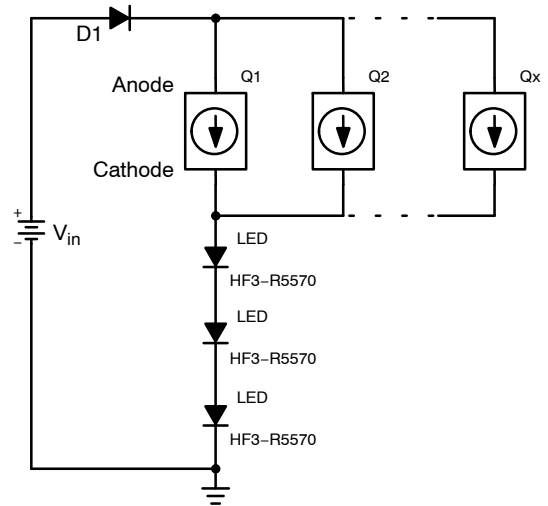
**Figure 6. Power Dissipation vs. Ambient Temperature @  $T_J = 150^\circ\text{C}$**

APPLICATIONS



**Figure 7. Typical Application Circuit  
(30 mA each LED String)**

Number of LED's that can be connected is determined by:  
**D1 is a reverse battery protection diode**  
**LED's =  $(V_{in} - Q_X V_F + D1 V_F) / LED V_F$**   
**Example:  $V_{in} = 12 \text{ Vdc}$ ,  $Q_X V_F = 3.5 \text{ Vdc}$ ,  $D1 V_F = 0.7 \text{ V}$**   
**LED  $V_F = 2.2 \text{ Vdc @ 30 mA}$**   
 **$(12 \text{ Vdc} - 4.2 \text{ Vdc}) / 2.2 \text{ Vdc} = 3 \text{ LEDs in series.}$**



**Figure 8. Typical Application Circuit  
(90 mA each LED String)**

Number of LED's that can be connected is determined by:  
**D1 is a reverse battery protection diode**  
**Example:  $V_{in} = 12 \text{ Vdc}$ ,  $Q_X V_F = 3.5 \text{ Vdc}$ ,  $D1 V_F = 0.7 \text{ V}$**   
**LED  $V_F = 2.6 \text{ Vdc @ 90 mA}$**   
 **$(12 \text{ Vdc} - (3.5 + 0.7 \text{ Vdc})) / 2.6 \text{ Vdc} = 3 \text{ LEDs in series.}$**   
**Number of Drivers = LED current / 30 mA**  
 **$90 \text{ mA} / 30 \text{ mA} = 3 \text{ Drivers (Q1, Q2, Q3)}$**

Comparison of LED Circuit using CCR vs. Resistor Biasing

ON Semiconductor CCR Design	Resistor Biased Design
Constant brightness over full Automotive Supply Voltage (more efficient), see Figure 9	Large variations in brightness over full Automotive Supply Voltage
Little variation of power in LEDs, see Figure 10	Large variations of current (power) in LEDs
Constant current extends LED strings lifetime, see Figure 9	High Supply Voltage/ Higher Current in LED strings limits lifetime
Current decreases as voltage increases, see Figure 9	Current increases as voltage increases
Current supplied to LED string decreases as temperature increases (self-limiting), see Figure 2	LED current decreases as temperature increases
No resistors needed	Requires costly inventory (need for several resistor values to match LED intensity)
Fewer components, less board space required	More components, more board space required
Surface mount component	Through-hole components

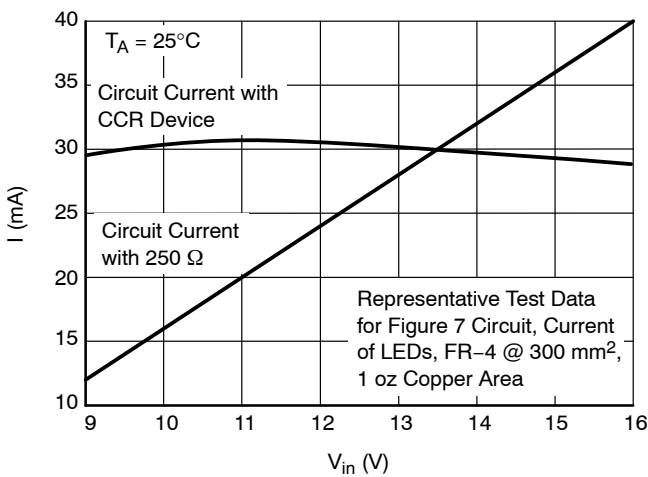


Figure 9. Series Circuit Current

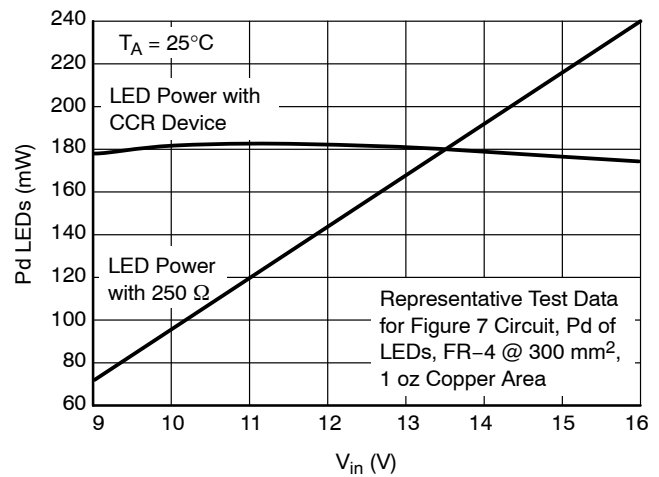


Figure 10. LED Power

Current Regulation: Pulse Mode ( $I_{reg(P)}$ ) vs DC Steady-State ( $I_{reg(SS)}$ )

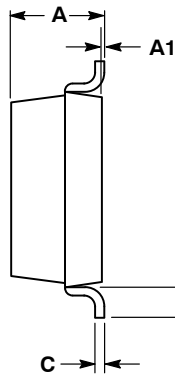
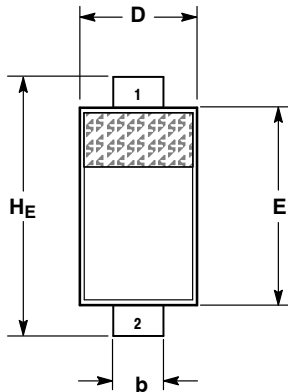
There are two methods to measure current regulation: Pulse mode ( $I_{reg(P)}$ ) testing is applicable for factory and incoming inspection of a CCR where test times are a minimum. ( $t \leq 300 \mu\text{s}$ ). DC Steady-State ( $I_{reg(SS)}$ ) testing is applicable for application verification where the CCR will be operational for seconds, minutes, or even hours. ON Semiconductor has correlated the difference in  $I_{reg(P)}$  to

$I_{reg(SS)}$  for stated board material, size, copper area and copper thickness.  $I_{reg(P)}$  will always be greater than  $I_{reg(SS)}$  due to the die temperature rising during  $I_{reg(SS)}$ . This heating effect can be minimized during circuit design with the correct selection of board material, metal trace size and weight, for the operating current, voltage, board operating temperature ( $T_A$ ) and package. (Refer to Thermal Characteristics table).

# NSI45030AT1G

## PACKAGE DIMENSIONS

SOD-123  
CASE 425-04  
ISSUE E

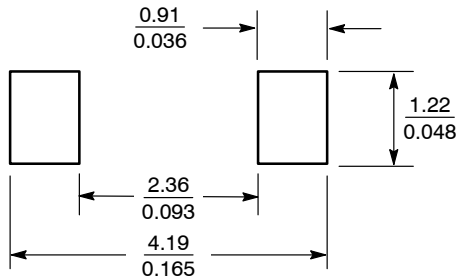


- NOTES:  
1. DIMENSIONING AND TOLERANCING PER ANSI Y14.5M, 1982.  
2. CONTROLLING DIMENSION: INCH.

DIM	MILLIMETERS			INCHES		
	MIN	NOM	MAX	MIN	NOM	MAX
A	0.94	1.17	1.35	0.037	0.046	0.053
A1	0.00	0.05	0.10	0.000	0.002	0.004
b	0.51	0.61	0.71	0.020	0.024	0.028
c	---	---	0.15	---	---	0.006
D	1.40	1.60	1.80	0.055	0.063	0.071
E	2.54	2.69	2.84	0.100	0.106	0.112
HE	3.56	3.68	3.86	0.140	0.145	0.152
L	0.25	---	---	0.010	---	---


STYLE 1:  
PIN 1. CATHODE  
2. ANODE

## SOLDERING FOOTPRINT\*



SCALE 10:1 (mm/inches)

\*For additional information on our Pb-Free strategy and soldering details, please download the ON Semiconductor Soldering and Mounting Techniques Reference Manual, SOLDERRM/D.

ON Semiconductor and  are registered trademarks of Semiconductor Components Industries, LLC (SCILLC). SCILLC reserves the right to make changes without further notice to any products herein. SCILLC makes no warranty, representation or guarantee regarding the suitability of its products for any particular purpose, nor does SCILLC assume any liability arising out of the application or use of any product or circuit, and specifically disclaims any and all liability, including without limitation special, consequential or incidental damages. "Typical" parameters which may be provided in SCILLC data sheets and/or specifications can and do vary in different applications and actual performance may vary over time. All operating parameters, including "Typicals" must be validated for each customer application by customer's technical experts. SCILLC does not convey any license under its patent rights nor the rights of others. SCILLC products are not designed, intended, or authorized for use as components in systems intended for surgical implant into the body, or other applications intended to support or sustain life, or for any other application in which the failure of the SCILLC product could create a situation where personal injury or death may occur. Should Buyer purchase or use SCILLC products for any such unintended or unauthorized application, Buyer shall indemnify and hold SCILLC and its officers, employees, subsidiaries, affiliates, and distributors harmless against all claims, costs, damages, and expenses, and reasonable attorney fees arising out of, directly or indirectly, any claim of personal injury or death associated with such unintended or unauthorized use, even if such claim alleges that SCILLC was negligent regarding the design or manufacture of the part. SCILLC is an Equal Opportunity/Affirmative Action Employer. This literature is subject to all applicable copyright laws and is not for resale in any manner.

## PUBLICATION ORDERING INFORMATION

LITERATURE FULFILLMENT:  
Literature Distribution Center for ON Semiconductor  
P.O. Box 5163, Denver, Colorado 80217 USA  
Phone: 303-675-2175 or 800-344-3860 Toll Free USA/Canada  
Fax: 303-675-2176 or 800-344-3867 Toll Free USA/Canada  
Email: orderlit@onsemi.com

N. American Technical Support: 800-282-9855 Toll Free  
USA/Canada  
Europe, Middle East and Africa Technical Support:  
Phone: 421 33 790 2910  
Japan Customer Focus Center  
Phone: 81-3-5773-3850

ON Semiconductor Website: [www.onsemi.com](http://www.onsemi.com)  
Order Literature: <http://www.onsemi.com/orderlit>  
For additional information, please contact your local Sales Representative



Компания «ЭлектроПласт» предлагает заключение долгосрочных отношений при поставках импортных электронных компонентов на взаимовыгодных условиях!

Наши преимущества:

- Оперативные поставки широкого спектра электронных компонентов отечественного и импортного производства напрямую от производителей и с крупнейших мировых складов;
- Поставка более 17-ти миллионов наименований электронных компонентов;
- Поставка сложных, дефицитных, либо снятых с производства позиций;
- Оперативные сроки поставки под заказ (от 5 рабочих дней);
- Экспресс доставка в любую точку России;
- Техническая поддержка проекта, помощь в подборе аналогов, поставка прототипов;
- Система менеджмента качества сертифицирована по Международному стандарту ISO 9001;
- Лицензия ФСБ на осуществление работ с использованием сведений, составляющих государственную тайну;
- Поставка специализированных компонентов (Xilinx, Altera, Analog Devices, Intersil, Interpoint, Microsemi, Aeroflex, Peregrine, Syfer, Eurofarad, Texas Instrument, Miteq, Cobham, E2V, MA-COM, Hittite, Mini-Circuits, General Dynamics и др.);

Помимо этого, одним из направлений компании «ЭлектроПласт» является направление «Источники питания». Мы предлагаем Вам помощь Конструкторского отдела:

- Подбор оптимального решения, техническое обоснование при выборе компонента;
- Подбор аналогов;
- Консультации по применению компонента;
- Поставка образцов и прототипов;
- Техническая поддержка проекта;
- Защита от снятия компонента с производства.



#### Как с нами связаться

**Телефон:** 8 (812) 309 58 32 (многоканальный)

**Факс:** 8 (812) 320-02-42

**Электронная почта:** [org@eplast1.ru](mailto:org@eplast1.ru)

**Адрес:** 198099, г. Санкт-Петербург, ул. Калинина, дом 2, корпус 4, литера А.