

### FEATURES

- 1 A maximum output current**
- Low input voltage supply range**  
 $V_{IN} = 1.10\text{ V to }1.98\text{ V}$ , no external bias supply required
- Fixed output voltage range:  $V_{OUT\_FIXED} = 0.9\text{ V to }1.5\text{ V}$**
- Adjustable output voltage range:  $V_{OUT\_ADJ} = 0.5\text{ V to }1.5\text{ V}$**
- Ultralow noise:  $2\ \mu\text{V rms}$ , 100 Hz to 100 kHz**
- Noise spectral density**  
 $4\ \text{nV}/\sqrt{\text{Hz}}$  at 10 kHz  
 $3\ \text{nV}/\sqrt{\text{Hz}}$  at 100 kHz
- Low dropout voltage: 30 mV typical at 1 A load**
- Operating supply current: 4.5 mA typical at no load**
- $\pm 1.5\%$  fixed output voltage accuracy over line, load, and temperature**
- Excellent power supply rejection ratio (PSRR) performance**  
 $67\ \text{dB}$  typical at 10 kHz at 1 A load  
 $51\ \text{dB}$  typical at 100 kHz at 1 A load
- Excellent load/line transient response**
- Soft start to reduce inrush current**
- Optimized for small  $10\ \mu\text{F}$  ceramic capacitors**
- Current-limit and thermal overload protection**
- Power-good indicator**
- Precision enable**
- 16-lead,  $3\ \text{mm} \times 3\ \text{mm}$  LFCSP package**

### APPLICATIONS

- Regulation to noise sensitive applications such as radio frequency (RF) transceivers, analog-to-digital converter (ADC) and digital-to-analog converter (DAC) circuits, phase-locked loops (PLLs), voltage controlled oscillators (VCOs) and clocking integrated circuits
- Field-programmable gate array (FPGA) and digital signal processor (DSP) supplies
- Medical and healthcare
- Industrial and instrumentation

### GENERAL DESCRIPTION

The ADP1761 is a low noise, low dropout (LDO) linear regulator. It is designed to operate from a single input supply with an input voltage as low as 1.10 V, without the requirement of an external bias supply to increase efficiency and provide up to 1 A of output current.

The low 30 mV typical dropout voltage at a 1 A load allows the ADP1761 to operate with a small headroom while maintaining regulation and providing better efficiency. The ADP1761 is optimized for stable operation with small  $10\ \mu\text{F}$  ceramic output capacitors.

Rev. C

[Document Feedback](#)

Information furnished by Analog Devices is believed to be accurate and reliable. However, no responsibility is assumed by Analog Devices for its use, nor for any infringements of patents or other rights of third parties that may result from its use. Specifications subject to change without notice. No license is granted by implication or otherwise under any patent or patent rights of Analog Devices. Trademarks and registered trademarks are the property of their respective owners.

### TYPICAL APPLICATION CIRCUITS

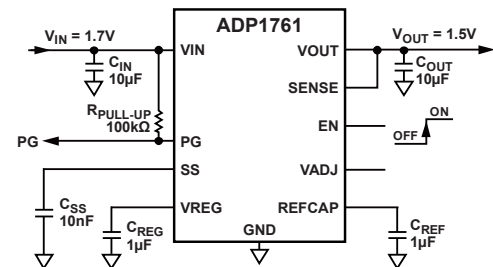

Figure 1. Fixed Output Operation

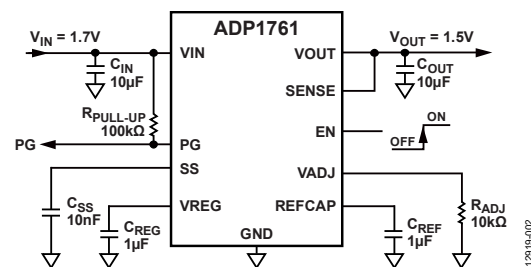

Figure 2. Adjustable Output Operation

Table 1. Related Devices

Device	Input Voltage	Maximum Current	Fixed/Adjustable	Package
<a href="#">ADP1762</a>	1.10 V to 1.98 V	2 A	Fixed/adjustable	16-lead LFCSP
<a href="#">ADP1763</a>	1.10 V to 1.98 V	3 A	Fixed/adjustable	16-lead LFCSP
<a href="#">ADP1740/ADP1741</a>	1.6 V to 3.6 V	2 A	Fixed/adjustable	16-lead LFCSP
<a href="#">ADP1752/ADP1753</a>	1.6 V to 3.6 V	0.8 A	Fixed/adjustable	16-lead LFCSP
<a href="#">ADP1754/ADP1755</a>	1.6 V to 3.6 V	1.2 A	Fixed/adjustable	16-lead LFCSP

The ADP1761 delivers optimal transient performance with minimal board area.

The ADP1761 is available in fixed output voltages ranging from 0.9 V to 1.5 V. The output of the adjustable output model can be set from 0.5 V to 1.5 V through an external resistor connected between VADJ and ground.

The ADP1761 has an externally programmable soft start time by connecting a capacitor to the SS pin. Short-circuit and thermal overload protection circuits prevent damage in adverse conditions. The ADP1761 is available in a small 16-lead LFCSP package for the smallest footprint solution to meet a variety of applications.

**TABLE OF CONTENTS**

Features .....	1	Soft Start Function .....	11
Applications .....	1	Adjustable Output Voltage .....	12
Typical Application Circuits .....	1	Enable Feature .....	12
General Description .....	1	Power-Good (PG) Feature .....	12
Revision History .....	2	Applications Information .....	13
Specifications .....	3	Capacitor Selection .....	13
Input and Output Capacitor: Recommended Specifications .....	4	Undervoltage Lockout .....	14
Absolute Maximum Ratings .....	5	Current-Limit and Thermal Overload Protection .....	14
Thermal Data .....	5	Thermal Considerations .....	14
Thermal Resistance/Parameter .....	5	PCB Layout Considerations .....	17
ESD Caution .....	5	Outline Dimensions .....	18
Pin Configuration and Function Descriptions .....	6	Ordering Guide .....	18
Typical Performance Characteristics .....	7		
Theory of Operation .....	11		

**REVISION HISTORY**

<b>3/2020—Rev. B to Rev. C</b>		<b>9/2016—Rev. 0 to Rev. A</b>	
Changes to Thermal Data Section, Thermal Resistance/Parameter Section, and Table 5 .....	5	Changes to Figure 23 and Figure 24 .....	11
<b>8/2019—Rev. A to Rev. B</b>		<b>4/2016—Revision 0: Initial Version</b>	
Change to Undervoltage Lockout, Hysteresis Parameter .....	4		
Updated Outline Dimensions .....	18		

## SPECIFICATIONS

$V_{IN} = V_{OUT} + 0.2 \text{ V}$  or  $V_{IN} = 1.1 \text{ V}$ , whichever is greater,  $I_{LOAD} = 10 \text{ mA}$ ,  $C_{IN} = 10 \mu\text{F}$ ,  $C_{OUT} = 10 \mu\text{F}$ ,  $C_{REF} = 1 \mu\text{F}$ ,  $C_{REG} = 1 \mu\text{F}$ ,  $T_A = 25^\circ\text{C}$ , minimum and maximum limits at  $T_J = -40^\circ\text{C}$  to  $+125^\circ\text{C}$ , unless otherwise noted.

Table 2.

Parameter	Symbol	Test Conditions/Comments	Min	Typ	Max	Unit	
INPUT VOLTAGE SUPPLY RANGE	$V_{IN}$	$T_J = -40^\circ\text{C}$ to $+125^\circ\text{C}$	1.10		1.98	V	
CURRENT							
Operating Supply Current	$I_{GND}$	$I_{LOAD} = 0 \mu\text{A}$		4.5	8	mA	
		$I_{LOAD} = 10 \text{ mA}$		4.9	8	mA	
		$I_{LOAD} = 100 \text{ mA}$		5.5	8.5	mA	
		$I_{LOAD} = 1 \text{ A}$		7.3	11	mA	
Shutdown Current	$I_{GND-SD}$	EN = GND		2		$\mu\text{A}$	
		$T_J = -40^\circ\text{C}$ to $+85^\circ\text{C}$ , $V_{IN} = (V_{OUT} + 0.2 \text{ V})$ to $1.98 \text{ V}$			180	$\mu\text{A}$	
		$T_J = 85^\circ\text{C}$ to $125^\circ\text{C}$ , $V_{IN} = (V_{OUT} + 0.2 \text{ V})$ to $1.98 \text{ V}$			800	$\mu\text{A}$	
OUTPUT NOISE <sup>1</sup>							
Noise Spectral Density	$OUT_{NOISE}$	10 Hz to 100 kHz, $V_{IN} = 1.1 \text{ V}$ , $V_{OUT} = 0.9 \text{ V}$		12		$\mu\text{V rms}$	
		100 Hz to 100 kHz, $V_{IN} = 1.1 \text{ V}$ , $V_{OUT} = 0.9 \text{ V}$		2		$\mu\text{V rms}$	
		10 Hz to 100 kHz, $V_{IN} = 1.5 \text{ V}$ , $V_{OUT} = 1.3 \text{ V}$		15		$\mu\text{V rms}$	
		100 Hz to 100 kHz, $V_{IN} = 1.5 \text{ V}$ , $V_{OUT} = 1.3 \text{ V}$		2		$\mu\text{V rms}$	
		10 Hz to 100 kHz, $V_{IN} = 1.7 \text{ V}$ , $V_{OUT} = 1.5 \text{ V}$		21		$\mu\text{V rms}$	
		100 Hz to 100 kHz, $V_{IN} = 1.7 \text{ V}$ , $V_{OUT} = 1.5 \text{ V}$		2		$\mu\text{V rms}$	
POWER SUPPLY REJECTION RATIO <sup>1</sup>	PSRR	$I_{LOAD} = 1 \text{ A}$ , modulated $V_{IN}$					
		10 kHz, $V_{OUT} = 1.3 \text{ V}$ , $V_{IN} = 1.5 \text{ V}$		67		dB	
		100 kHz, $V_{OUT} = 1.3 \text{ V}$ , $V_{IN} = 1.5 \text{ V}$		51		dB	
OUTPUT VOLTAGE	$V_{OUT\_FIXED}$ $V_{OUT\_ADJ}$ $V_{OUT}$	$T_A = 25^\circ\text{C}$					
		Output Voltage Range		0.9	1.5	V	
		Fixed Output Voltage Accuracy	$I_{LOAD} = 100 \text{ mA}$ , $T_A = 25^\circ\text{C}$		-0.5	+0.5	%
			$10 \text{ mA} < I_{LOAD} < 1 \text{ A}$ , $V_{IN} = (V_{OUT} + 0.2 \text{ V})$ to $1.98 \text{ V}$ , $T_J = 0^\circ\text{C}$ to $85^\circ\text{C}$		-1	+1.5	%
			$10 \text{ mA} < I_{LOAD} < 1 \text{ A}$ , $V_{IN} = (V_{OUT} + 0.2 \text{ V})$ to $1.98 \text{ V}$		-1.5	+1.5	%
ADJUSTABLE PIN CURRENT	$I_{ADJ}$	$T_A = 25^\circ\text{C}$	49.5	50.0	50.5	$\mu\text{A}$	
		$V_{IN} = (V_{OUT} + 0.2 \text{ V})$ to $1.98 \text{ V}$	48.8	50.0	51.0	$\mu\text{A}$	
ADJUSTABLE OUTPUT VOLTAGE GAIN FACTOR	$A_D$	$T_A = 25^\circ\text{C}$		3.0			
		$V_{IN} = (V_{OUT} + 0.2 \text{ V})$ to $1.98 \text{ V}$	2.95		3.055		
REGULATION							
Line Regulation	$\Delta V_{OUT}/\Delta V_{IN}$	$V_{IN} = (V_{OUT} + 0.2 \text{ V})$ to $1.98 \text{ V}$	-0.15		+0.15	%/V	
		$I_{LOAD} = 10 \text{ mA}$ to $1 \text{ A}$		0.25	0.44	%/A	
DROPOUT VOLTAGE <sup>3</sup>	$V_{DROPOUT}$	$I_{LOAD} = 100 \text{ mA}$ , $V_{OUT} = 1.2 \text{ V}$		12	23	mV	
		$I_{LOAD} = 1 \text{ A}$ , $V_{OUT} = 1.2 \text{ V}$		30	53	mV	
START-UP TIME <sup>1,4</sup>	$T_{START-UP}$	$C_{SS} = 10 \text{ nF}$ , $V_{OUT} = 1.3 \text{ V}$		0.6		ms	
SOFT START CURRENT	$I_{SS}$	$1.1 \text{ V} \leq V_{IN} \leq 1.98 \text{ V}$	8	10	12	$\mu\text{A}$	

Parameter	Symbol	Test Conditions/Comments	Min	Typ	Max	Unit
CURRENT-LIMIT THRESHOLD <sup>5</sup>	I <sub>LIMIT</sub>		1.5	2	2.4	A
THERMAL SHUTDOWN						
Threshold	T <sub>SD</sub>	T <sub>J</sub> rising		150		°C
Hysteresis	T <sub>SD-HYS</sub>			15		°C
POWER-GOOD (PG) OUTPUT THRESHOLD						
Output Voltage						
Falling	P <sub>G</sub> FALL	1.1 V ≤ V <sub>IN</sub> ≤ 1.98 V		-7.5		%
Rising	P <sub>G</sub> RISE	1.1 V ≤ V <sub>IN</sub> ≤ 1.98 V		-5		%
PG OUTPUT						
Output Voltage Low	P <sub>G</sub> LOW	1.1 V ≤ V <sub>IN</sub> ≤ 1.98 V, I <sub>PG</sub> ≤ 1 mA			0.35	V
Leakage Current	I <sub>PG-LKG</sub>	1.1 V ≤ V <sub>IN</sub> ≤ 1.98 V		0.01	1	μA
Delay <sup>1</sup>	P <sub>G</sub> DELAY	EN <sub>RIISING</sub> to P <sub>G</sub> RIISING		0.75		ms
PRECISION EN INPUT		1.1 V ≤ V <sub>IN</sub> ≤ 1.98 V				
Logic Input						
High	EN <sub>HIGH</sub>		595	625	690	mV
Low	EN <sub>LOW</sub>		550	580	630	mV
Input Logic Hysteresis	EN <sub>HYS</sub>			45		mV
Input Leakage Current	I <sub>EN-LKG</sub>	EN = V <sub>IN</sub> or GND		0.01	1	μA
Input Delay Time	t <sub>EN-DLY</sub>	From EN rising from 0 V to V <sub>IN</sub> to 0.1 × V <sub>OUT</sub>		100		μs
UNDERVOLTAGE LOCKOUT						
Input Voltage						
Rising	UVLO <sub>RISE</sub>	T <sub>J</sub> = -40°C to +125°C		1.01	1.06	V
Falling	UVLO <sub>FALL</sub>	T <sub>J</sub> = -40°C to +125°C	0.87	0.93		V
Hysteresis	UVLO <sub>HYS</sub>			80		mV

<sup>1</sup> Guaranteed by design and characterization; not production tested.

<sup>2</sup> Based on an endpoint calculation using 10 mA and 1 A loads.

<sup>3</sup> Dropout voltage is defined as the input to output voltage differential when the input voltage is set to the nominal output voltage, which applies only for output voltages above 1.1 V.

<sup>4</sup> Start-up time is defined as the time from the rising edge of EN to V<sub>OUT</sub> being at 90% of the nominal value.

<sup>5</sup> Current-limit threshold is defined as the current at which the output voltage drops to 90% of the specified typical value. For example, the current limit for a 1.0 V output voltage is defined as the current that causes the output voltage to drop to 90% of 1.0 V, or 0.9 V.

## INPUT AND OUTPUT CAPACITOR: RECOMMENDED SPECIFICATIONS

Table 3.

Parameter	Symbol	Test Conditions/Comments	Min	Typ	Max	Unit
CAPACITANCE <sup>1</sup>		T <sub>A</sub> = -40°C to +125°C				
Input	C <sub>IN</sub>		7.0	10		μF
Output	C <sub>OUT</sub>		7.0	10		μF
Regulator	C <sub>REG</sub>		0.7	1		μF
Reference	C <sub>REF</sub>		0.7	1		μF
CAPACITOR EQUIVALENT SERIES RESISTANCE (ESR)		T <sub>A</sub> = -40°C to +125°C				
C <sub>IN</sub> , C <sub>OUT</sub>	R <sub>ESR</sub>		0.001		0.5	Ω
C <sub>REG</sub> , C <sub>REF</sub>			0.001		0.2	Ω

<sup>1</sup> The minimum input and output capacitance must be >7.0 μF over the full range of the operating conditions. Consider the full range of the operating conditions in the application during device selection to ensure that the minimum capacitance specification is met. X7R and X5R type capacitors are recommended. Y5V and Z5U capacitors are not recommended for use with any LDO.

## ABSOLUTE MAXIMUM RATINGS

Table 4.

Parameter	Rating
VIN to GND	−0.3 V to +2.16 V
EN to GND	−0.3 V to +3.96 V
VOOUT to GND	−0.3 V to VIN
SENSE to GND	−0.3 V to VIN
VREG to GND	−0.3 V to VIN
REFCAP to GND	−0.3 V to VIN
VADJ to GND	−0.3 V to VIN
SS to GND	−0.3 V to VIN
PG to GND	−0.3 V to +3.96 V
Storage Temperature Range	−65°C to +150°C
Operating Temperature Range	−40°C to +125°C
Operating Junction Temperature	125°C
Lead Temperature (Soldering, 10 sec)	300°C

Stresses at or above those listed under Absolute Maximum Ratings may cause permanent damage to the product. This is a stress rating only; functional operation of the product at these or any other conditions above those indicated in the operational section of this specification is not implied. Operation beyond the maximum operating conditions for extended periods may affect product reliability.

### THERMAL DATA

Absolute maximum ratings apply individually only, not in combination. The ADP1761 can be damaged when the junction temperature limits are exceeded. The use of appropriate thermal management techniques is recommended to ensure that the maximum junction temperature does not exceed the limits shown in Table 4.

Use the following equation to calculate the junction temperature ( $T_J$ ) from the board temperature ( $T_{BOARD}$ ) or package top temperature ( $T_{TOP}$ )

$$T_J = T_{BOARD} + (P_D \times \Psi_{JB})$$

$$T_J = T_{TOP} + (P_D \times \Psi_{JT})$$

$\Psi_{JB}$  is the junction to board thermal characterization parameter and  $\Psi_{JT}$  is the junction to top thermal characterization parameter with units of °C/W.

$\Psi_{JB}$  of the package is based on modeling and calculation using a 4-layer board. JESD51-12, *Guidelines for Reporting and Using Electronic Package Thermal Information*, states that thermal characterization parameters are not the same as thermal resistances.  $\Psi_{JB}$  measures the component power flowing through multiple thermal paths rather than a single path as in thermal resistance,  $\theta_{JB}$ . Therefore,  $\Psi_{JB}$  thermal paths include convection from the top of the package as well as radiation from the package, factors that make  $\Psi_{JB}$  more useful in real-world applications.

### THERMAL RESISTANCE/PARAMETER

Values shown in Table 5 are calculated in compliance with JEDEC standards for thermal reporting.  $\theta_{JA}$  is the natural convection junction to ambient thermal resistance measured in a one cubic foot sealed enclosure.  $\theta_{JC}$  is the junction to case thermal resistance.  $\theta_{JB}$  is the junction to board thermal resistance.  $\Psi_{JB}$  is the junction to board thermal characterization parameter.  $\Psi_{JT}$  is the junction to top thermal characterization parameter.

In applications where high maximum power dissipation exists, close attention to thermal board design is required. Thermal resistance/parameter values may vary, depending on the PCB material, layout, and environmental conditions.

Table 5. Thermal Resistance/Parameter

Package Type	$\theta_{JA}$	$\theta_{JB}$	$\theta_{JC-T}$	$\theta_{JC-B}$	$\Psi_{JB}$	$\Psi_{JT}$	Unit
CP-16-22 <sup>1</sup>	50.95	29.31	49.53	8.53	29.31	0.3	°C/W

<sup>1</sup> Thermal resistance/parameter simulated values are based on a JEDEC 2S2P thermal test board for  $\Psi_{JT}$ ,  $\Psi_{JB}$ ,  $\theta_{JA}$  and  $\theta_{JB}$  and a JEDEC 150P thermal test board for  $\theta_{JC}$  with four thermal vias. See JEDEC JESD51-12.

### ESD CAUTION



**ESD (electrostatic discharge) sensitive device.** Charged devices and circuit boards can discharge without detection. Although this product features patented or proprietary protection circuitry, damage may occur on devices subjected to high energy ESD. Therefore, proper ESD precautions should be taken to avoid performance degradation or loss of functionality.

## PIN CONFIGURATION AND FUNCTION DESCRIPTIONS

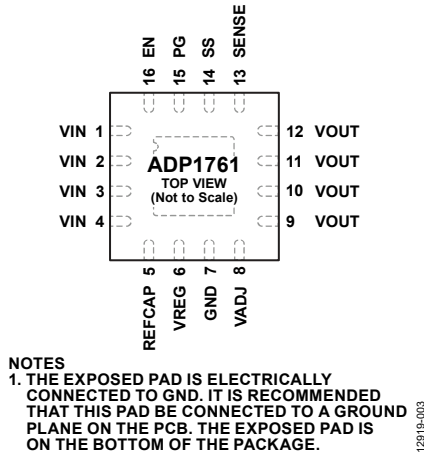

Figure 3. Pin Configuration

Table 6. Pin Function Descriptions

Pin No.	Mnemonic	Description
1 to 4	VIN	Regulator Input Supply. Bypass VIN to GND with a 10 $\mu$ F or greater capacitor. Note that all four VIN pins must be connected to the source supply.
5	REFCAP	Reference Filter Capacitor. Connect a 1 $\mu$ F capacitor from the REFCAP pin to ground. Do not connect a load to ground.
6	VREG	Regulated Input Supply to LDO Amplifier. Bypass VREG to GND with a 1 $\mu$ F or greater capacitor. Do not connect a load to ground.
7	GND	Ground.
8	VADJ	Adjustable Voltage Pin for the Adjustable Output Option. Connect a 10 k $\Omega$ external resistor between the VADJ pin and ground to set the output voltage to 1.5 V. For the fixed output option, leave this pin floating.
9 to 12	VOUT	Regulated Output Voltage. Bypass VOUT to GND with a 10 $\mu$ F or greater capacitor. Note that all four VOUT pins must be connected to the load.
13	SENSE	Sense Input. The SENSE pin measures the actual output voltage at the load and feeds it to the error amplifier. Connect VSENSE as close to the load as possible to minimize the effect of IR voltage drop between VOUT and the load.
14	SS	Soft Start Pin. A 10 nF capacitor connected to the SS pin and ground sets the start-up time to 0.6 ms.
15	PG	Power-Good Output. This open-drain output requires an external pull-up resistor. If the device is in shutdown mode, current-limit mode, or thermal shutdown mode, or if VOUT falls below 90% of the nominal output voltage, the PG pin immediately transitions low.
16	EN	Enable Input. Drive the EN pin high to turn on the regulator. Drive the EN pin low to turn off the regulator. For automatic startup, connect the EN pin to the VIN pin.
	EP	Exposed Pad. The exposed pad is electrically connected to GND. It is recommended that this pad be connected to a ground plane on the PCB. The exposed pad is on the bottom of the package.

# TYPICAL PERFORMANCE CHARACTERISTICS

$V_{IN} = 1.5\text{ V}$ ,  $V_{OUT} = 1.3\text{ V}$ ,  $T_A = 25^\circ\text{C}$ , unless otherwise noted.

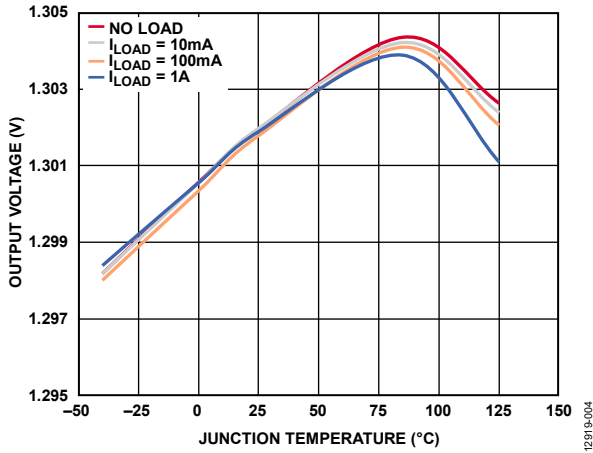

Figure 4. Output Voltage ( $V_{OUT}$ ) vs. Junction Temperature

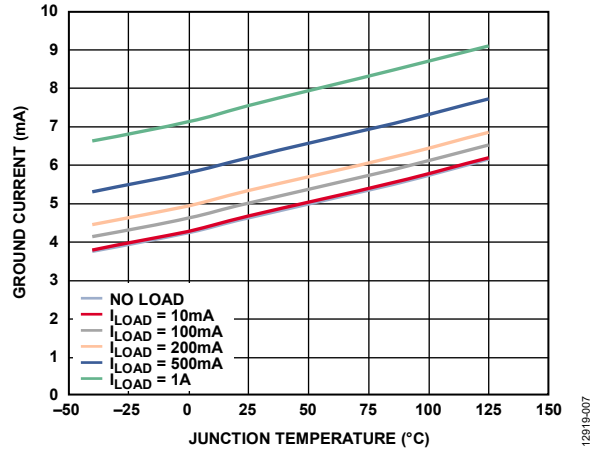

Figure 7. Ground Current vs. Junction Temperature

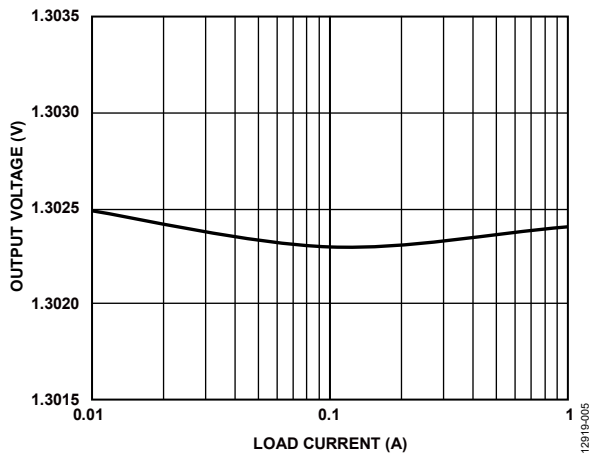

Figure 5. Output Voltage ( $V_{OUT}$ ) vs. Load Current

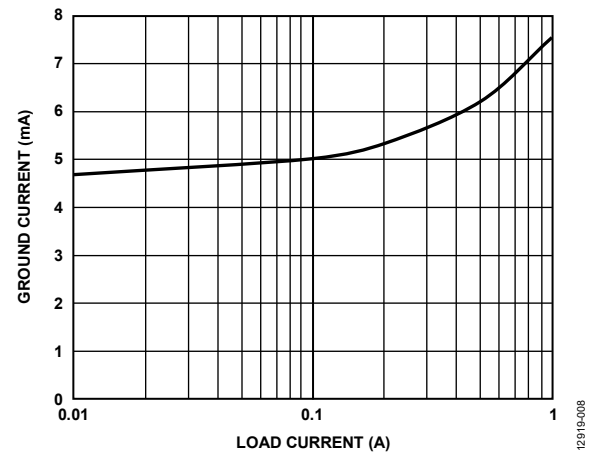

Figure 8. Ground Current vs. Load Current

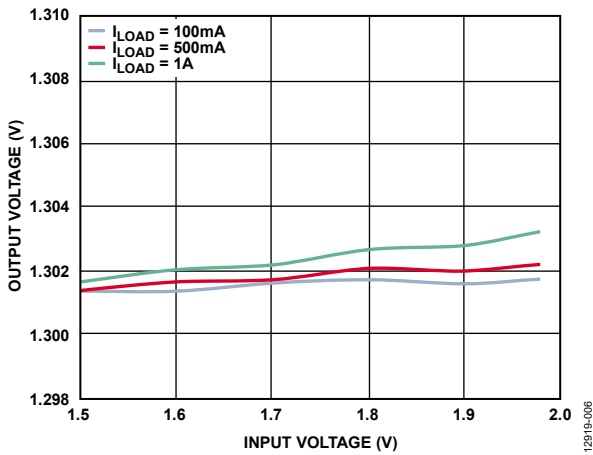

Figure 6. Output Voltage vs. Input Voltage

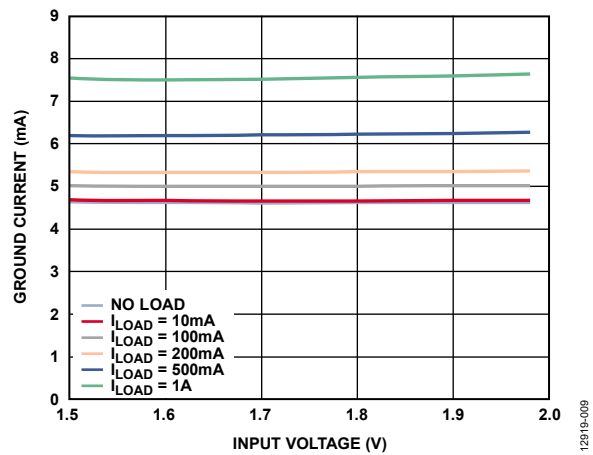

Figure 9. Ground Current vs. Input Voltage

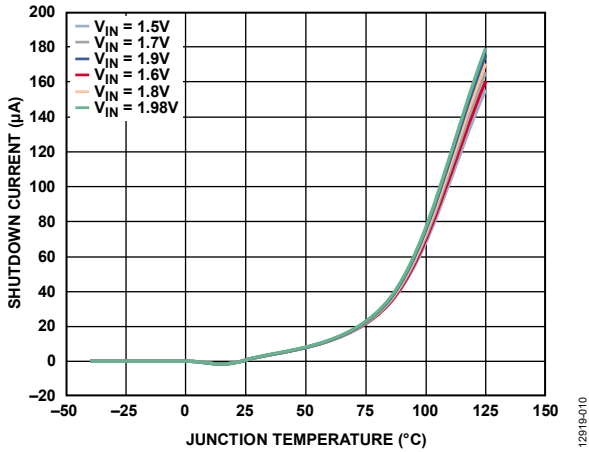

Figure 10. Shutdown Current vs. Junction Temperature at Various Input Voltages ( $V_{IN}$ )

12919-010

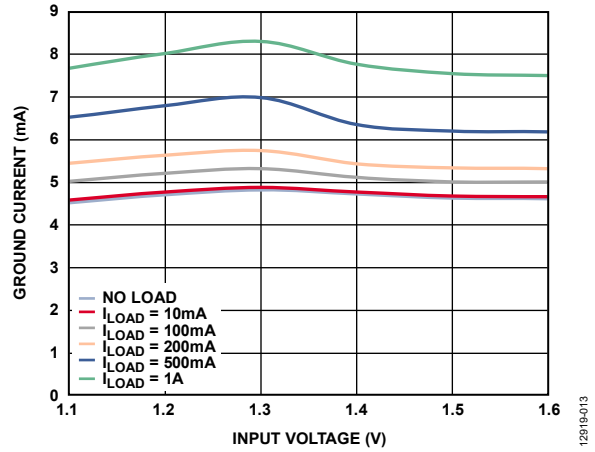

Figure 13. Ground Current vs. Input Voltage (in Dropout),  $V_{OUT} = 1.3 V$

12919-013

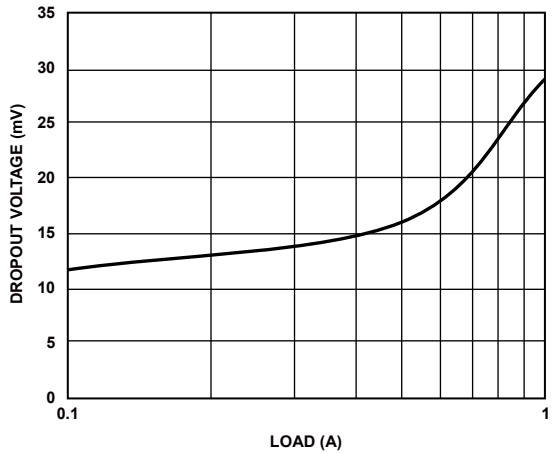

Figure 11. Dropout Voltage vs. Load Current,  $V_{OUT} = 1.3 V$

12919-011

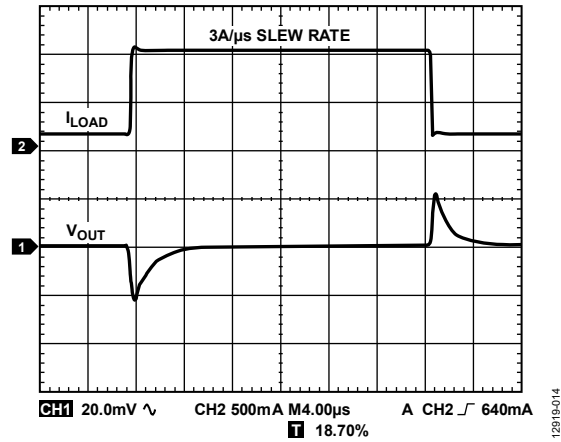

Figure 14. Load Transient Response,  $C_{OUT} = 10 \mu F$ ,  $V_{IN} = 1.7 V$ ,  $V_{OUT} = 1.3 V$

12919-014

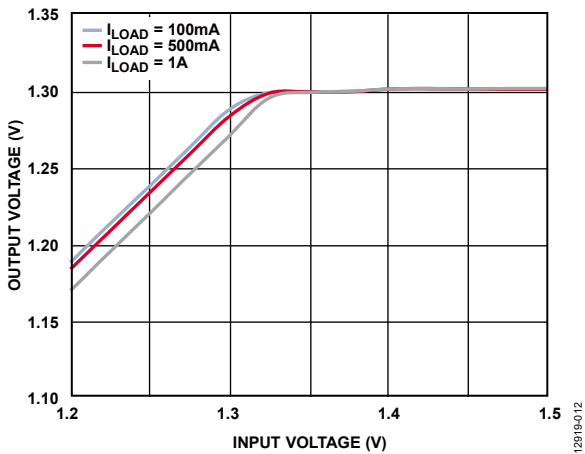

Figure 12. Output Voltage vs. Input Voltage (in Dropout),  $V_{OUT} = 1.3 V$

12919-012

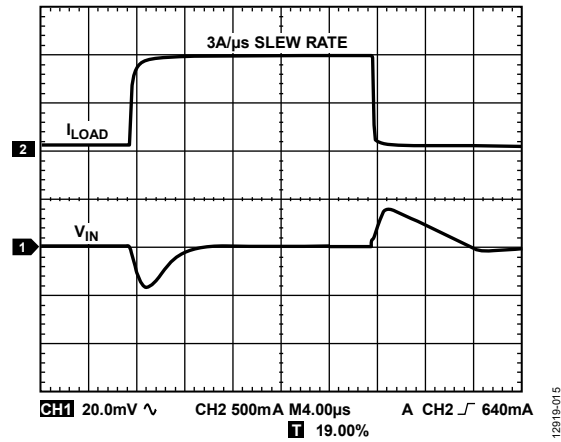

Figure 15. Load Transient Response,  $C_{OUT} = 47 \mu F$ ,  $V_{IN} = 1.7 V$ ,  $V_{OUT} = 1.3 V$

12919-015



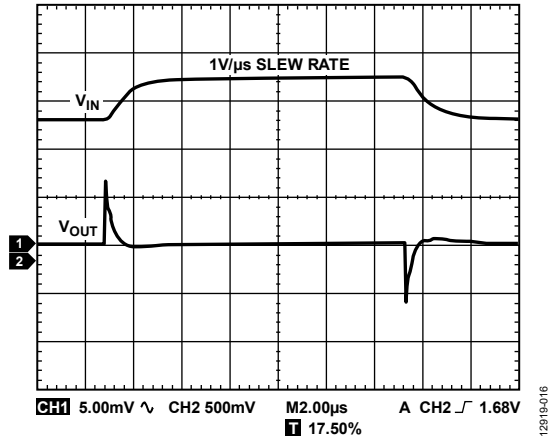

Figure 16. Line Transient Response, Load Current = 1 A,  $V_{IN}$  = 1.5 V to 1.98 V Step,  $V_{OUT}$  = 1.3 V

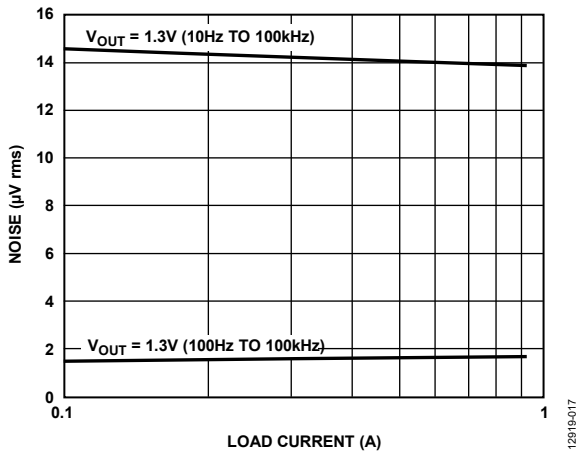

Figure 17. Noise vs. Load Current for Various Output Voltages

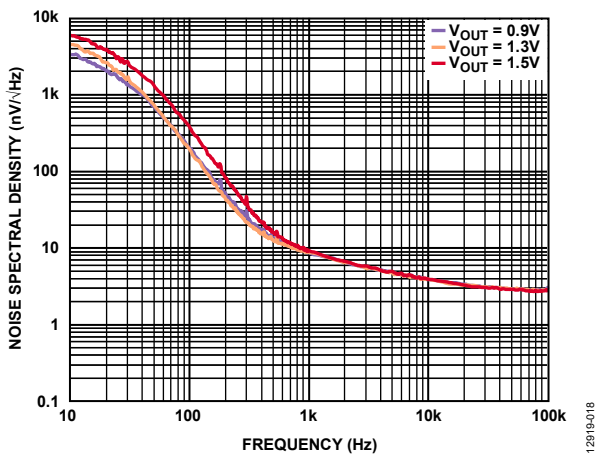

Figure 18. Noise Spectral Density vs. Frequency for Various Output Voltages, Load Current = 100 mA

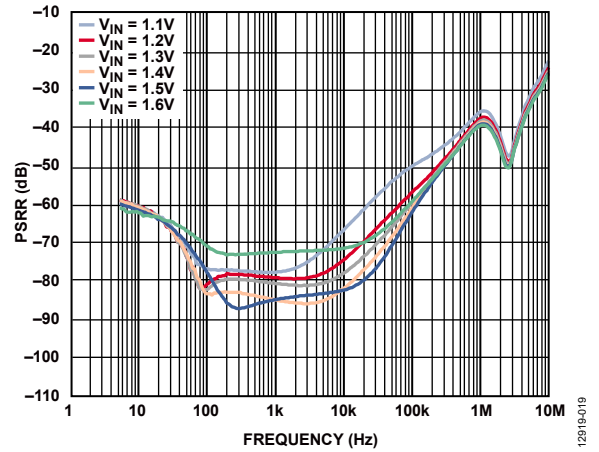

Figure 19. Power Supply Rejection Ratio (PSRR) vs. Frequency for Various  $V_{IN}$ ,  $V_{OUT}$  = 0.9 V, Load Current = 1 A

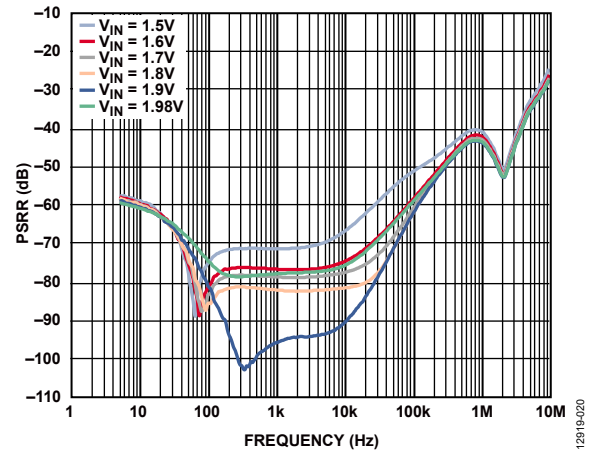

Figure 20. Power Supply Rejection Ratio (PSRR) vs. Frequency for Various  $V_{IN}$ ,  $V_{OUT}$  = 1.3 V, Load Current = 1 A

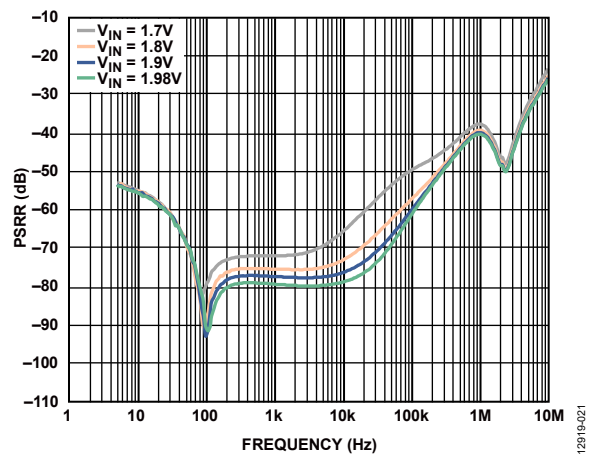

Figure 21. Power Supply Rejection Ratio (PSRR) vs. Frequency for Various  $V_{IN}$ ,  $V_{OUT}$  = 1.5 V, Load Current = 1 A

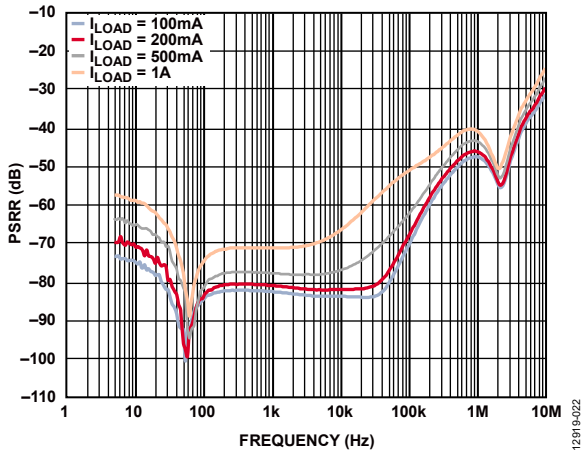

Figure 22. Power Supply Rejection Ratio (PSRR) vs. Frequency for Various Loads,  $V_{OUT} = 1.3\text{ V}$ ,  $V_{IN} = 1.5\text{ V}$

## THEORY OF OPERATION

The ADP1761 is an LDO, low noise linear regulator that uses an advanced proprietary architecture to achieve high efficiency regulation. It also provides high PSRR and excellent line and load transient response using a small 10  $\mu\text{F}$  ceramic output capacitor. The device operates from a 1.10 V to 1.98 V input rail to provide up to 1 A of output current. Supply current in shutdown mode is 2  $\mu\text{A}$ .

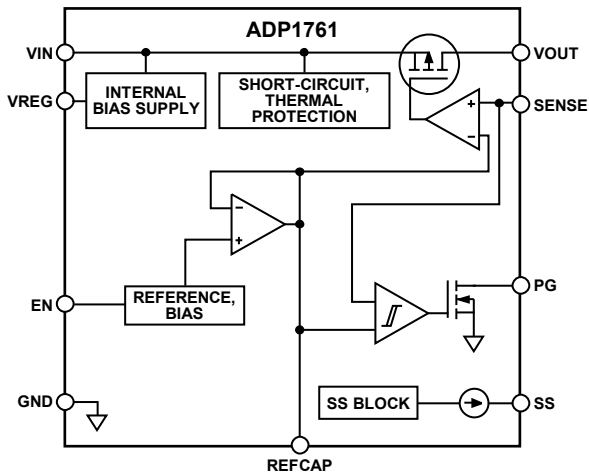

Figure 23. Functional Block Diagram, Fixed Output

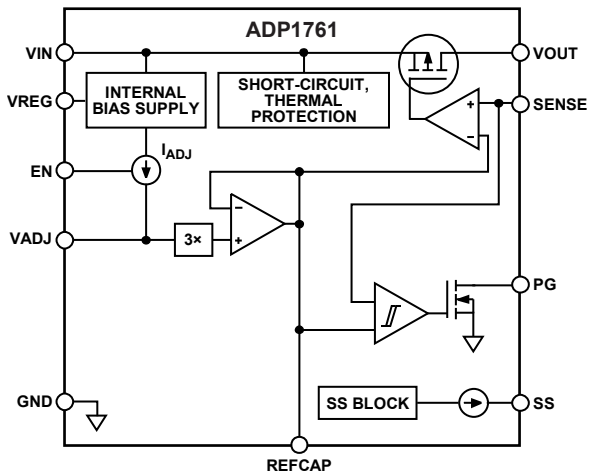

Figure 24. Functional Block Diagram, Adjustable Output

Internally, the ADP1761 consists of a reference, an error amplifier, and a pass device. The output current is delivered via the pass device, which is controlled by the error amplifier, forming a negative feedback system that ideally drives the feedback voltage to equal the reference voltage. If the feedback voltage is lower than the reference voltage, the negative feedback drives more current, increasing the output voltage. If the feedback voltage is higher than the reference voltage, the negative feedback drives less current, decreasing the output voltage.

The ADP1761 is available in output voltages ranging from 0.9 V to 1.5 V for a fixed output. Contact a local Analog Devices, Inc., sales representative for other fixed voltage options. The adjustable output option can be set from 0.5 V to 1.5 V.

The ADP1761 uses the EN pin to enable and disable the VOUT pin under normal operating conditions. When EN is high, VOUT turns on. When EN is low, VOUT turns off. For automatic startup, tie EN to VIN.

### SOFT START FUNCTION

For applications that require a controlled startup, the ADP1761 provides a programmable soft start function. The programmable soft start is useful for reducing inrush current upon startup and for providing voltage sequencing. To implement soft start, connect a small ceramic capacitor from SS to ground. At startup, a 10  $\mu\text{A}$  current source charges this capacitor. The voltage at SS limits the ADP1761 start-up output voltage, providing a smooth ramp-up to the nominal output voltage. To calculate the start-up time for the fixed output and adjustable output, use the following equations:

$$t_{\text{START-UP\_FIXED}} = t_{\text{DELAY}} + V_{\text{REF}} \times (C_{\text{SS}}/I_{\text{SS}}) \quad (1)$$

$$t_{\text{START-UP\_ADJ}} = t_{\text{DELAY}} + V_{\text{ADJ}} \times (C_{\text{SS}}/I_{\text{SS}}) \quad (2)$$

where:

$t_{\text{DELAY}}$  is a fixed delay of 100  $\mu\text{s}$ .

$V_{\text{REF}}$  is a 0.5 V internal reference for the fixed output model option.

$C_{\text{SS}}$  is the soft start capacitance from SS to GND.

$I_{\text{SS}}$  is the current sourced from SS (10  $\mu\text{A}$ ).

$V_{\text{ADJ}}$  is the voltage at the VADJ pin equal to  $R_{\text{ADJ}} \times I_{\text{ADJ}}$ .

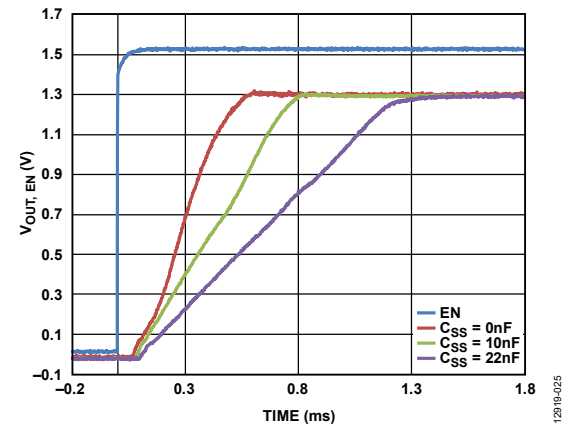

Figure 25. Fixed  $V_{\text{OUT}}$  Ramp-Up with External Soft Start Capacitor ( $V_{\text{OUT,EN}}$ ) vs. Time

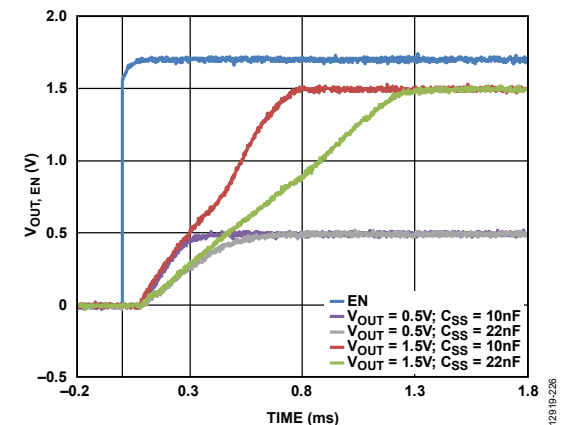

Figure 26. Adjustable  $V_{\text{OUT}}$  Ramp-Up with External Soft Start Capacitor ( $V_{\text{OUT,EN}}$ ) vs. Time

**ADJUSTABLE OUTPUT VOLTAGE**

The output voltage of the ADP1761 can be set over a 0.5 V to 1.5 V range. Connect a resistor ( $R_{ADJ}$ ) from the VADJ pin to ground to set the output voltage. To calculate the output voltage, use the following equation:

$$V_{OUT} = A_D \times (R_{ADJ} \times I_{ADJ}) \tag{3}$$

where:

$A_D$  is the gain factor with a typical value of 3.0 between the VADJ pin and the VOUT pin.

$I_{ADJ}$  is the 50.0  $\mu$ A constant current out of the VADJ pin.

**ENABLE FEATURE**

The ADP1761 uses the EN pin to enable and disable the VOUT pins under normal operating conditions. As shown in Figure 27, when a rising voltage on EN crosses the active threshold, VOUT turns on. When a falling voltage on EN crosses the inactive threshold, VOUT turns off.

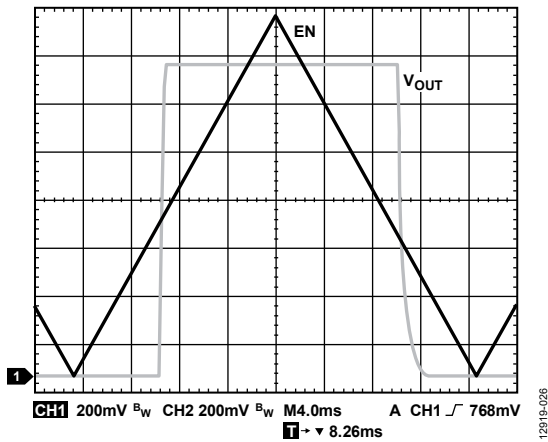

Figure 27. Typical EN Pin Operation

As shown in Figure 28, the EN pin has hysteresis built in. This hysteresis prevents on/off oscillations that can occur due to noise on the EN pin as it passes through the threshold points.

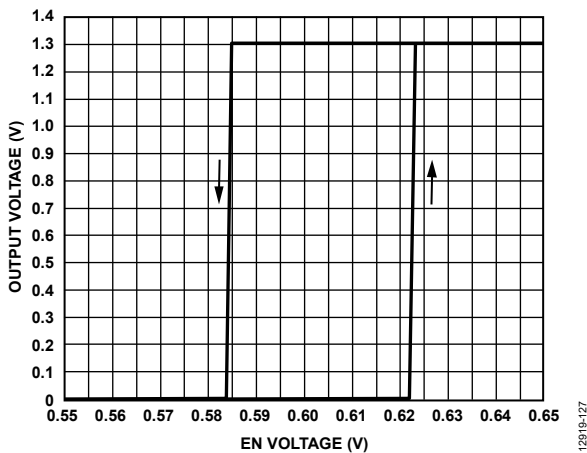

Figure 28. Output Voltage vs. Typical EN Pin Voltage,  $V_{OUT} = 1.3$  V

**POWER-GOOD (PG) FEATURE**

The ADP1761 provides a power-good pin (PG) to indicate the status of the output. This open-drain output requires an external pull-up resistor that can be connected to  $V_{IN}$  or  $V_{OUT}$ . If the device is in shutdown mode, current-limit mode, or thermal shutdown, or if it falls below 90% of the nominal output voltage, PG immediately transitions low. During soft start, the rising threshold of the power-good signal is 95% of the nominal output voltage.

The open-drain output is held low when the ADP1761 has a sufficient input voltage to turn on the internal PG transistor. An optional soft start delay can be detected. The PG transistor is terminated via a pull-up resistor to  $V_{OUT}$  or  $V_{IN}$ .

Power-good accuracy is 92.5% of the nominal regulator output voltage when this voltage is rising, with a 95% trip point when this voltage is falling.

Regulator input voltage brownouts or glitches trigger a power no good if  $V_{OUT}$  falls below 92.5%.

A normal power-down triggers a power good when  $V_{OUT}$  is at 95%.

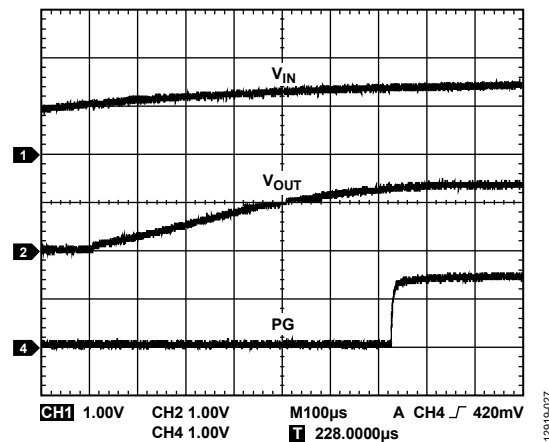

Figure 29. Typical PG Behavior vs.  $V_{OUT}$ ,  $V_{IN}$  Rising ( $V_{OUT} = 1.3$  V)

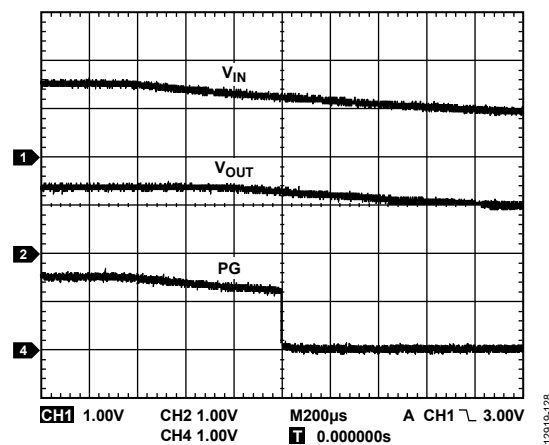

Figure 30. Typical PG Behavior vs.  $V_{OUT}$ ,  $V_{IN}$  Falling ( $V_{OUT} = 1.3$  V)

# APPLICATIONS INFORMATION

## CAPACITOR SELECTION

### Output Capacitor

The ADP1761 is designed for operation with small, space-saving ceramic capacitors, but it can function with most commonly used capacitors as long as care is taken with the effective series resistance (ESR) value. The ESR of the output capacitor affects the stability of the LDO control loop. A minimum of 10  $\mu\text{F}$  capacitance with an ESR of 500 m $\Omega$  or less is recommended to ensure the stability of the ADP1761. Transient response to changes in load current is also affected by output capacitance. Using a larger value of output capacitance improves the transient response of the ADP1761 to large changes in load current. Figure 31 and Figure 32 show the transient responses for output capacitance values of 10  $\mu\text{F}$  and 47  $\mu\text{F}$ , respectively.

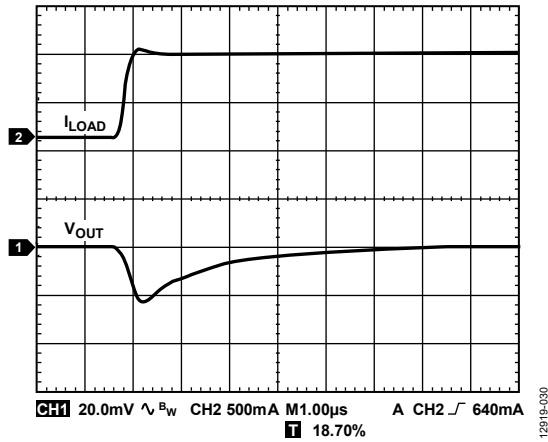

Figure 31. Output Transient Response,  $C_{OUT} = 10 \mu\text{F}$

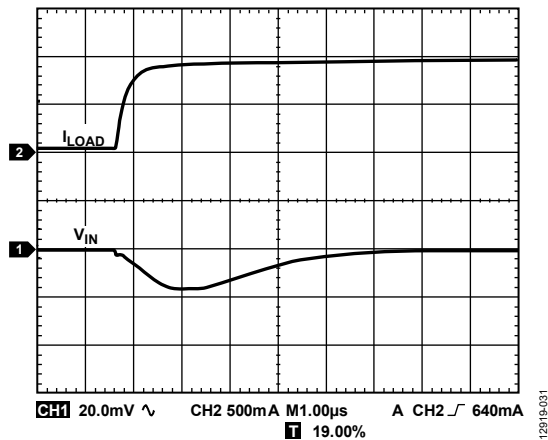

Figure 32. Output Transient Response,  $C_{OUT} = 47 \mu\text{F}$

### Input Bypass Capacitor

Connecting a 10  $\mu\text{F}$  capacitor from the VIN pin to the GND pin to ground reduces the circuit sensitivity to the PCB layout, especially when long input traces or a high source impedance is encountered. If output capacitance greater than 10  $\mu\text{F}$  is required, it is recommended that the input capacitor be increased to match it.

### Input and Output Capacitor Properties

Use any good quality ceramic capacitors with the ADP1761, as long as they meet the minimum capacitance and maximum ESR requirements. Ceramic capacitors are manufactured with a variety of dielectrics, each with different behavior over temperature and applied voltage. Capacitors must have a dielectric adequate to ensure the minimum capacitance over the necessary temperature range and dc bias conditions. X5R or X7R dielectrics with a voltage rating of 6.3 V or 10 V are recommended. Y5V and Z5U dielectrics are not recommended, due to poor temperature and dc bias characteristics.

Figure 33 shows the capacitance vs. bias voltage characteristics of an 0805 case, 10  $\mu\text{F}$ , 10 V, X5R capacitor. The voltage stability of a capacitor is strongly influenced by the capacitor size and voltage rating. In general, a capacitor in a larger package or with a higher voltage rating exhibits better stability. The temperature variation of the X5R dielectric is about  $\pm 15\%$  over the  $-40^\circ\text{C}$  to  $+85^\circ\text{C}$  temperature range and is not a function of package size or voltage rating.

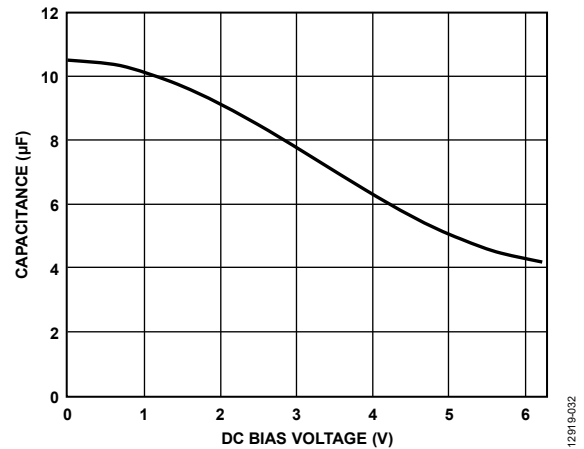

Figure 33. Capacitance vs. DC Bias Voltage

Use Equation 4 to determine the worst case capacitance, accounting for capacitor variation over temperature, component tolerance, and voltage.

$$C_{EFF} = C_{OUT} \times (1 - tempco) \times (1 - TOL) \tag{4}$$

where:

$C_{EFF}$  is the effective capacitance at the operating voltage.

$C_{OUT}$  is the output capacitor.

$Tempco$  is the worst case capacitor temperature coefficient.

$TOL$  is the worst case component tolerance.

In this example, the worst case temperature coefficient ( $tempco$ ) over  $-40^\circ\text{C}$  to  $+85^\circ\text{C}$  is assumed to be 15% for an X5R dielectric. The tolerance of the capacitor ( $TOL$ ) is assumed to be 10%, and  $C_{OUT} = 10 \mu\text{F}$  at 1.0 V, as shown in Figure 33.

Substituting these values in Equation 4 yields

$$C_{EFF} = 10 \mu\text{F} \times (1 - 0.15) \times (1 - 0.1) = 7.65 \mu\text{F}$$

Therefore, the capacitor chosen in this example meets the minimum capacitance requirement of the LDO over temperature and tolerance at the chosen output voltage.

To guarantee the performance of the ADP1761, it is imperative that the effects of dc bias, temperature, and tolerances on the behavior of the capacitors be evaluated for each application.

### UNDERVOLTAGE LOCKOUT

The ADP1761 has an internal undervoltage lockout circuit that disables all inputs and the output when the input voltage is less than approximately 1.06 V. The UVLO ensures that the ADP1761 inputs and the output behave in a predictable manner during power-up.

### CURRENT-LIMIT AND THERMAL OVERLOAD PROTECTION

The ADP1761 is protected against damage due to excessive power dissipation by current-limit and thermal overload protection circuits. The ADP1761 is designed to reach the current limit when the output load reaches 2 A (typical). When the output load exceeds 2 A, the output voltage is reduced to maintain a constant current limit.

Thermal overload protection is included, which limits the junction temperature to a maximum of 150°C (typical). Under extreme conditions (that is, high ambient temperature and power dissipation) when the junction temperature begins to rise above 150°C, the output is turned off, reducing the output current to zero. When the junction temperature drops below 135°C (typical), the output is turned on again, and the output current is restored to the nominal value.

Consider the case where a hard short from V<sub>OUT</sub> to ground occurs. At first, the ADP1761 reaches the current limit so that only 2 A is conducted into the short circuit. If self-heating of the junction becomes great enough to cause the temperature to rise above 150°C, thermal shutdown activates, turning off the output and reducing the output current to zero. As the junction temperature cools and drops below 135°C, the output turns on and conducts 2 A into the short circuit, again causing the junction temperature to rise above 150°C. This thermal oscillation between 135°C and 150°C causes a current oscillation between 2 A and 0 A that continues as long as the short circuit remains at the output.

Current-limit and thermal overload protections are intended to protect the device against accidental overload conditions. For reliable operation, limit the device power dissipation externally so that junction temperatures do not exceed 125°C.

### THERMAL CONSIDERATIONS

To guarantee reliable operation, the junction temperature of the ADP1761 must not exceed 125°C. To ensure that the junction temperature stays below this maximum value, the user needs to be aware of the parameters that contribute to junction temperature changes. These parameters include ambient temperature, power dissipation in the power device, and thermal resistance between the junction and ambient air ( $\theta_{JA}$ ). The  $\theta_{JA}$  value is dependent on the package assembly compounds used and the amount of copper to which the GND pin and the exposed pad (EPAD) of the package are soldered on the PCB. Table 7 shows typical  $\theta_{JA}$  values for the 16-lead LFCSP for various PCB copper sizes. Table 8 shows typical  $\Psi_{JB}$  values for the 16-lead LFCSP.

Table 7. Typical  $\theta_{JA}$  Values

Copper Size (mm <sup>2</sup> )	$\theta_{JA}$ (°C/W), LFCSP
25	138.1
100	102.9
500	76.9
1000	67.3
6400	56

Table 8. Typical  $\Psi_{JB}$  Values

Copper Size (mm <sup>2</sup> )	$\Psi_{JB}$ (°C/W) at 1 W
100	33.3
500	28.9
1000	28.5

To calculate the junction temperature of the ADP1761, use the following equation:

$$T_J = T_A + (P_D \times \theta_{JA}) \quad (5)$$

where:

$T_A$  is the ambient temperature.

$P_D$  is the power dissipation in the die, given by

$$P_D = ((V_{IN} - V_{OUT}) \times I_{LOAD}) + (V_{IN} \times I_{GND}) \quad (6)$$

where:

$V_{IN}$  and  $V_{OUT}$  are the input and output voltages, respectively.

$I_{LOAD}$  is the load current.

$I_{GND}$  is the ground current.

As shown in Equation 6, for a given ambient temperature and computed power dissipation, a minimum copper size requirement exists for the PCB to ensure that the junction temperature does not rise above 125°C.

Figure 34 through Figure 39 show the junction temperature calculations for the different ambient temperatures, load currents,  $V_{IN}$  to  $V_{OUT}$  differentials, and areas of PCB copper.

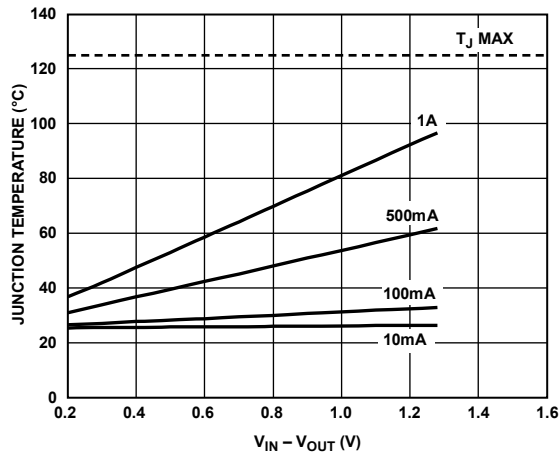

Figure 34. 6400 mm<sup>2</sup> of PCB Copper,  $T_A = 25^\circ\text{C}$

12919-034

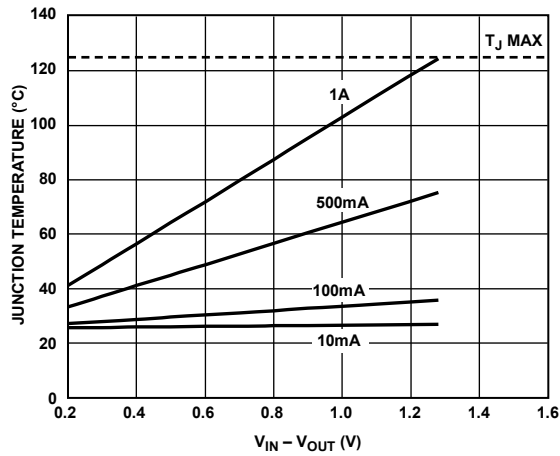

Figure 35. 500 mm<sup>2</sup> of PCB Copper,  $T_A = 25^\circ\text{C}$

12919-035

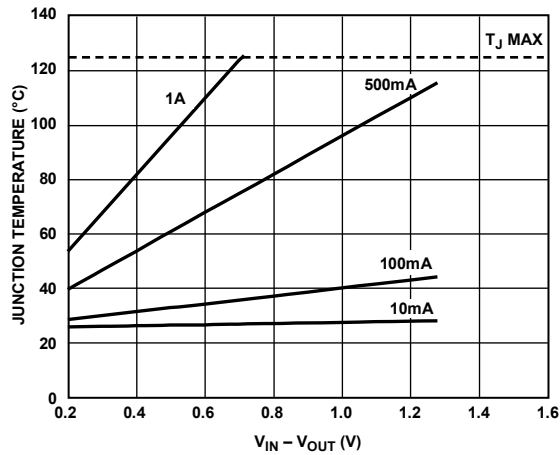

Figure 36. 25 mm<sup>2</sup> of PCB Copper,  $T_A = 25^\circ\text{C}$

12919-036

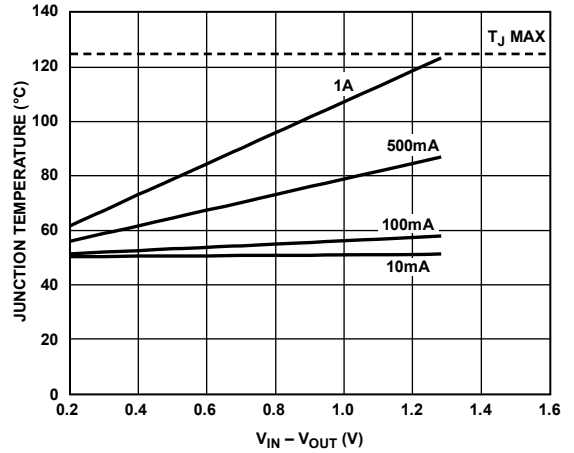

Figure 37. 6400 mm<sup>2</sup> of PCB Copper,  $T_A = 50^\circ\text{C}$

12919-037

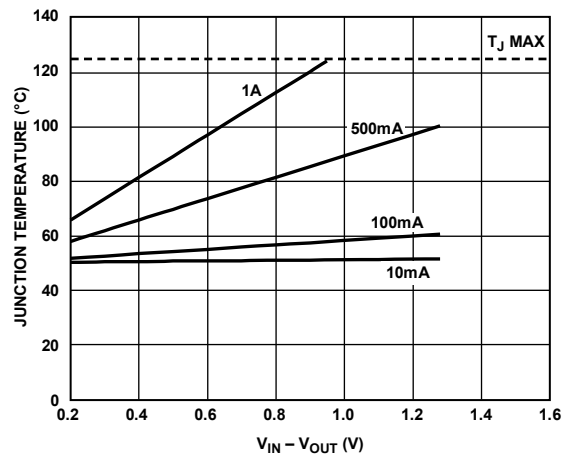

Figure 38. 500 mm<sup>2</sup> of PCB Copper,  $T_A = 50^\circ\text{C}$

12919-038

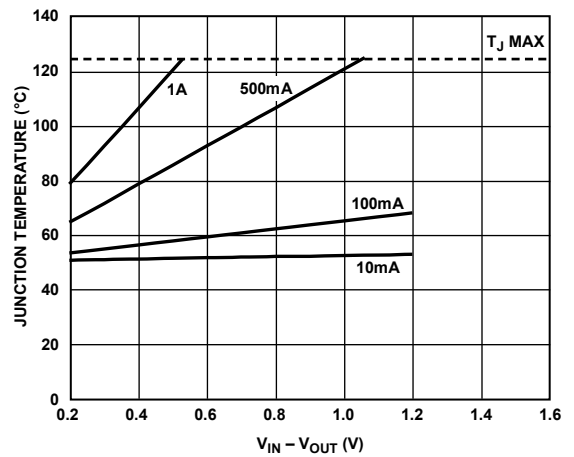

Figure 39. 25 mm<sup>2</sup> of PCB Copper,  $T_A = 50^\circ\text{C}$

12919-039

In cases where the board temperature is known, the thermal characterization parameter ( $\Psi_{JB}$ ) can estimate the junction temperature rise. The maximum junction temperature ( $T_J$ ) is calculated from the board temperature ( $T_B$ ) and power dissipation ( $P_D$ ) using the following formula:

$$T_J = T_B + (P_D \times \Psi_{JB}) \tag{7}$$

Figure 40 through Figure 43 show the junction temperature calculations for the different board temperatures, load currents,  $V_{IN}$  to  $V_{OUT}$  differentials, and areas of PCB copper.

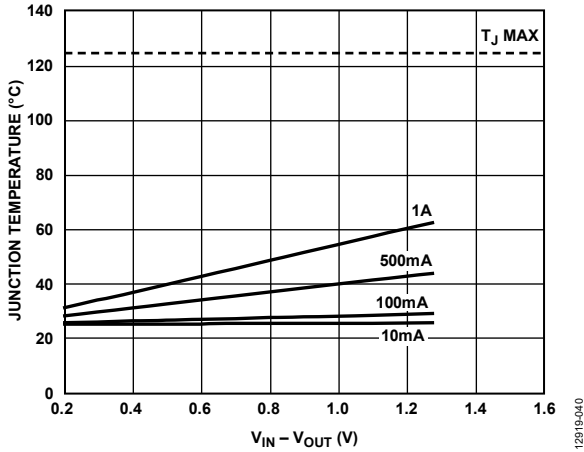

Figure 40. 500 mm<sup>2</sup> of PCB Copper, T<sub>B</sub> = 25°C

12919-040

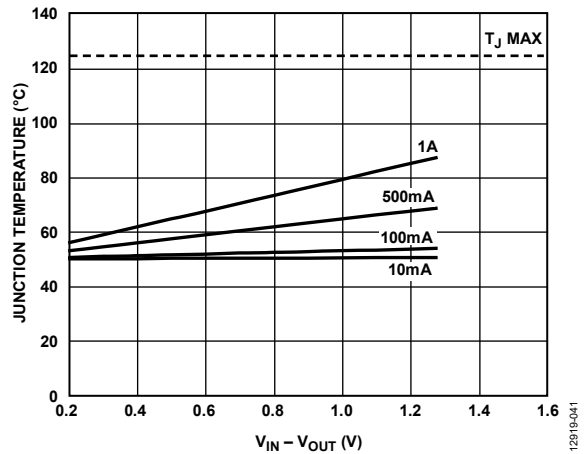

Figure 41. 500 mm<sup>2</sup> of PCB Copper, T<sub>B</sub> = 50°C

12919-041

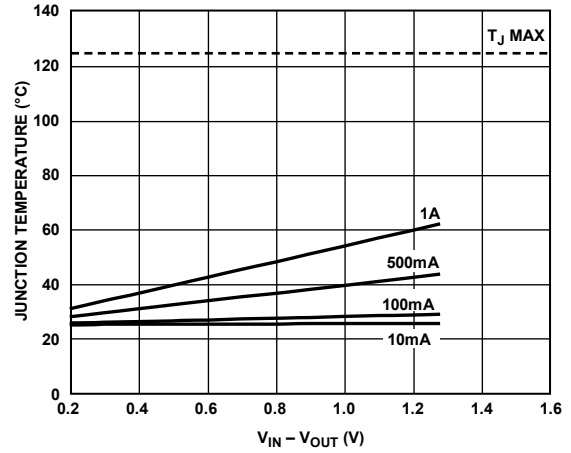

Figure 42. 1000 mm<sup>2</sup> of PCB Copper, T<sub>B</sub> = 25°C

12919-042

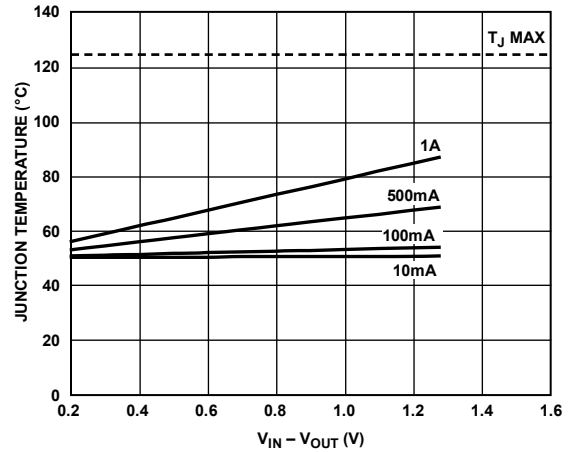

Figure 43. 1000 mm<sup>2</sup> of PCB Copper, T<sub>B</sub> = 50°C

12919-043



## PCB LAYOUT CONSIDERATIONS

Heat dissipation from the package can be improved by increasing the amount of copper attached to the pins of the ADP1761. However, as shown in Table 8, a point of diminishing returns is eventually reached, beyond which an increase in the copper size does not yield significant heat dissipation benefits.

Use the following recommendations when designing PCBs:

- Place the input capacitor as close as possible to the VIN and GND pins.
- Place the output capacitor as close as possible to the VOUT and GND pins.
- Place the soft start capacitor ( $C_{SS}$ ) as close as possible to the SS pin.
- Place the reference capacitor ( $C_{REF}$ ) and regulator capacitor ( $C_{REG}$ ) as close as possible to the REFCAP pin and the VREG pin, respectively.
- Connect the load as close as possible to the VOUT and SENSE pins.

Use of 0603 or 0805 size capacitors and resistors achieves the smallest possible footprint solution on boards where area is limited.



Figure 44. Evaluation Board

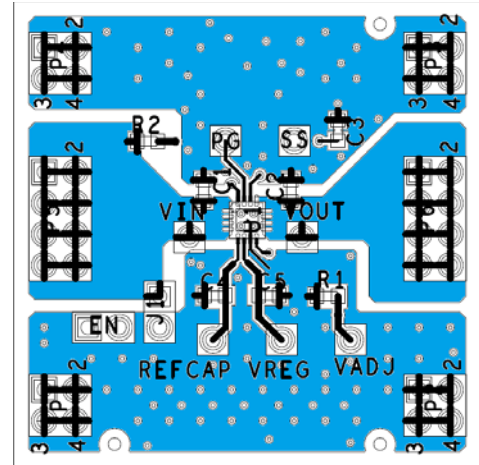

Figure 45. Typical Board Layout, Top Side

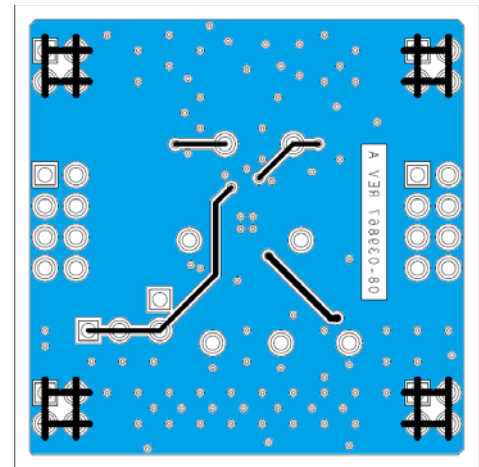
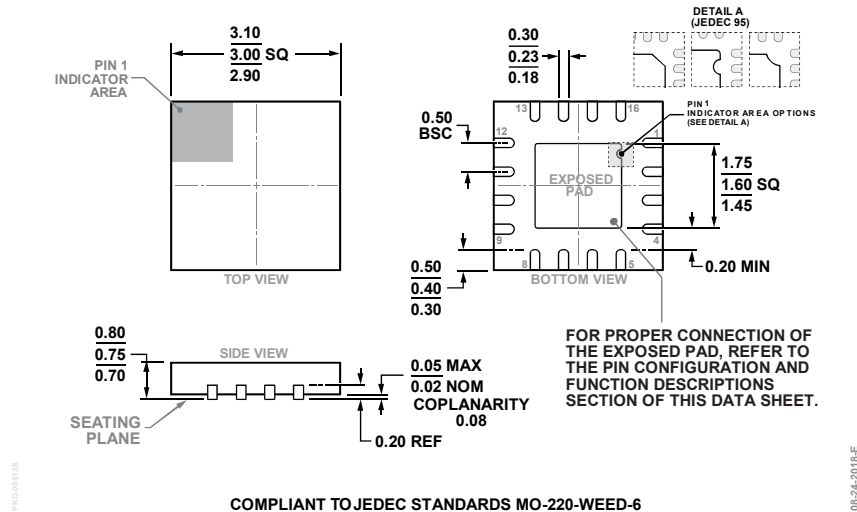

Figure 46. Typical Board Layout, Bottom Side

OUTLINE DIMENSIONS



COMPLIANT TO JEDEC STANDARDS MO-220-WEED-6  
 Figure 47. 16-Lead Lead Frame Chip Scale Package [LFCSP]  
 3 mm x 3 mm Body and 0.75 mm Package Height  
 (CP-16-22)  
 Dimensions shown in millimeters

ORDERING GUIDE

Model <sup>1</sup>	Temperature Range	Output Voltage (V) <sup>2</sup>	Package Description	Package Option	Marking Code
ADP1761ACPZ-R7	-40°C to +125°C	Adjustable	16-Lead Lead Frame Chip Scale Package [LFCSP]	CP-16-22	LRJ
ADP1761ACPZ-0.9-R7	-40°C to +125°C	0.9	16-Lead Lead Frame Chip Scale Package [LFCSP]	CP-16-22	LRK
ADP1761ACPZ0.95-R7	-40°C to +125°C	0.95	16-Lead Lead Frame Chip Scale Package [LFCSP]	CP-16-22	LUN
ADP1761ACPZ-1.0-R7	-40°C to +125°C	1.0	16-Lead Lead Frame Chip Scale Package [LFCSP]	CP-16-22	LRL
ADP1761ACPZ-1.1-R7	-40°C to +125°C	1.1	16-Lead Lead Frame Chip Scale Package [LFCSP]	CP-16-22	LRM
ADP1761ACPZ-1.2-R7	-40°C to +125°C	1.2	16-Lead Lead Frame Chip Scale Package [LFCSP]	CP-16-22	LRN
ADP1761ACPZ1.25-R7	-40°C to +125°C	1.25	16-Lead Lead Frame Chip Scale Package [LFCSP]	CP-16-22	LRP
ADP1761ACPZ-1.3-R7	-40°C to +125°C	1.3	16-Lead Lead Frame Chip Scale Package [LFCSP]	CP-16-22	LRQ
ADP1761ACPZ-1.5-R7	-40°C to +125°C	1.5	16-Lead Lead Frame Chip Scale Package [LFCSP]	CP-16-22	LRR
ADP1761-1.3-EVALZ		1.3	Evaluation Board		
ADP1761-ADJ-EVALZ		1.1	Evaluation Board		

<sup>1</sup> Z = RoHS Compliant Part.

<sup>2</sup> For additional options, contact a local Analog Devices sales or distribution representative. Additional voltage output options available include the following: 0.5 V, 0.55 V, 0.6 V, 0.65 V, 0.7 V, 0.75 V, 0.8 V, 0.85 V, 1.05 V, 1.15 V, 1.35 V, 1.4 V, or 1.45 V.



Компания «ЭлектроПласт» предлагает заключение долгосрочных отношений при поставках импортных электронных компонентов на взаимовыгодных условиях!

Наши преимущества:

- Оперативные поставки широкого спектра электронных компонентов отечественного и импортного производства напрямую от производителей и с крупнейших мировых складов;
- Поставка более 17-ти миллионов наименований электронных компонентов;
- Поставка сложных, дефицитных, либо снятых с производства позиций;
- Оперативные сроки поставки под заказ (от 5 рабочих дней);
- Экспресс доставка в любую точку России;
- Техническая поддержка проекта, помощь в подборе аналогов, поставка прототипов;
- Система менеджмента качества сертифицирована по Международному стандарту ISO 9001;
- Лицензия ФСБ на осуществление работ с использованием сведений, составляющих государственную тайну;
- Поставка специализированных компонентов (Xilinx, Altera, Analog Devices, Intersil, Interpoint, Microsemi, Aeroflex, Peregrine, Syfer, Eurofarad, Texas Instrument, Miteq, Cobham, E2V, MA-COM, Hittite, Mini-Circuits, General Dynamics и др.);

Помимо этого, одним из направлений компании «ЭлектроПласт» является направление «Источники питания». Мы предлагаем Вам помощь Конструкторского отдела:

- Подбор оптимального решения, техническое обоснование при выборе компонента;
- Подбор аналогов;
- Консультации по применению компонента;
- Поставка образцов и прототипов;
- Техническая поддержка проекта;
- Защита от снятия компонента с производства.



#### Как с нами связаться

**Телефон:** 8 (812) 309 58 32 (многоканальный)

**Факс:** 8 (812) 320-02-42

**Электронная почта:** [org@eplast1.ru](mailto:org@eplast1.ru)

**Адрес:** 198099, г. Санкт-Петербург, ул. Калинина, дом 2, корпус 4, литера А.