



00-9159-00X-501-X06

PREFIX _____

SERIES _____

NO. OF WAYS _____

CODE	NO. OF WAYS	DETAILS
002	2	SHEET 2
003	3	SHEET 3
004	4	SHEET 4
005	5	SHEET 5
006	6	SHEET 6

Elco Europe (A Division of AVX Ltd) CONFIDENTIAL PROPRIETY
 The document on this print and information therewith are PROPRIETY
 to Elco Europe (A Division of AVX Ltd) and shall not be copied
 or disclosed in whole or in part without Elco Europe's written consent.

SINGLE PART PCB STRIP CONNECTOR _____

CODE	DESCRIPTION	DETAILS
501	THROUGH THE BOARD - EDGE CARD - NO CAP	SHEETS 2 TO 6
502	THROUGH THE BOARD - EDGE CARD - CAP FITTED	SHEET 7

INSULATOR COLOUR _____

CODE	COLOUR	AVAILABILITY
9	WHITE	UL APPROVED - STANDARD



PLATING OPTION _____

CODE	CONTACT PLATING
06	GOLD PLATING ON NOSE WITH TIN ON TAILS

SHEET 1 OF 10

FORM-106-01-056-6 ISS 7

Release No.	History
102809	10.11.2011
	06.01.2012
	12.01.2012
	03.02.2012
	08.02.2012
	08.03.2012
	28.03.2012
	102876
	26.04.2012
	102879
	14.05.2012
	15.05.2012
	26.06.2012
	24.07.2012

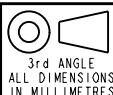

ELCO
 © COPYRIGHT ELCO EUROPE
 NOT TO BE DISCLOSED OR COPIED
 WITHOUT WRITTEN PERMISSION

Drawn	N.C.H.
Size	CV

Description	9159 THROUGH BOARD - ORDERING CODE
Part Number	00-9159-01_500S

DATE	06-Jan-12
Issue	6



THROUGH THE BOARD MATING EDGE CARD CONNECTOR - 2 WAY



SECTION A-A

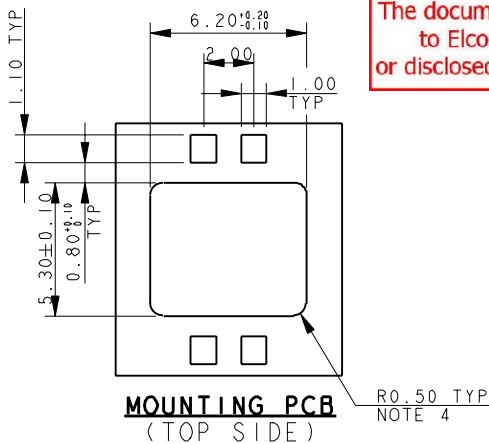

Elco Europe (A Division of AVX Ltd) CONFIDENTIAL PROPRIETY
The document on this print and information therewith are PROPRIETY
to Elco Europe (A Division of AVX Ltd) and shall not be copied
or disclosed in whole or in part without Elco Europe's written consent.

PACKING DETAILS

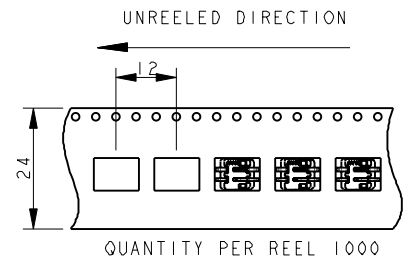
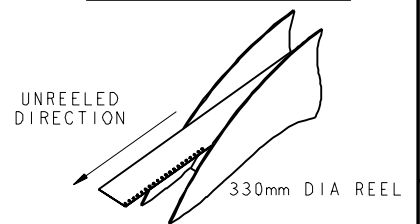

NOTES :-

1. THROUGH THE BOARD 2 WAY EDGE CARD CONNECTOR. FOR FURTHER DETAILS REFER TO PRODUCT SPECIFICATION 201-01-136.
2. FOR MATING PCB EITHER 0.8mm OR 1.6mm THICK. REFER TO SHEET 7 FOR MATING PCB DETAILS.
3. CONNECTOR TOP MOUNTING ON PCB.
4. UP TO 0.5mm RAD TO MATCH CONNECTOR PROFILE.
5. ALL DIMENSIONS ±0.20 UNLESS TOLERANCE SPECIFIED.
6. INSULATOR :- PA4T, GLASS FILLED, HALOGEN FREE, UL94 V-0, COLOUR REFER TO SHEET 1.
7. CONTACT :- COPPER ALLOY, NICKEL PLATED WITH GOLD FLASH ON NOSE AND TIN ON TAILS.
8. BRACKET :- COPPER ALLOY, PLATING, TIN OVER NICKEL.
9. PACKING IN TAPE AND REEL, 1000 PIECES PER REEL.
10. CONTACT TAILS COPLANARITY WITHIN 0.10.
11. REFER TO SHEET 10 FOR MATCHING PROTECTING CAP.
12. UL REFERENCE E90723.

ELCO EUROPE (A DIVISION OF AVX LTD.) CONFIDENTIAL PROPRIETARY
THE DRAWING ON THIS PRINT AND INFORMATION THEREWITH ARE PROPRIETARY TO ELCO EUROPE (A DIVISION OF AVX LTD.) AND SHALL NOT BE USED OR DISCLOSED IN WHOLE OR IN PART WITHOUT ELCO EUROPE'S WRITTEN CONSENT.

Release No.	History
102809	10.11.2011
102810	06.01.2012
102811	12.01.2012
102812	03.02.2012
102813	08.02.2012
102814	08.03.2012
102815	28.03.2012
102816	26.04.2012
102817	14.05.2012
102818	15.05.2012
102819	26.06.2012
102820	24.07.2012

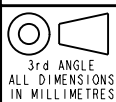

Drawn	N.C.H.	Description	6159 THROUGH BOARD - ORDERING CODE	DATE	06-Jan-12
Size	CV	Part Number	00-9159-01_500S	Issue	6

SHEET 2 OF 10

FORM-106-01-056-6 ISS 7



THROUGH THE BOARD MATING EDGE CARD CONNECTOR - 3 WAY

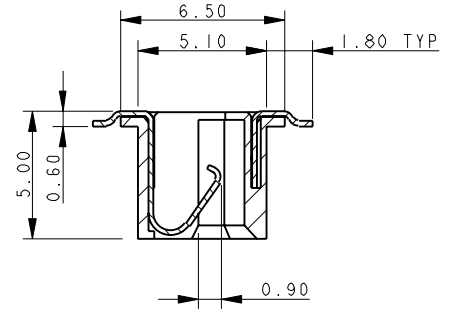
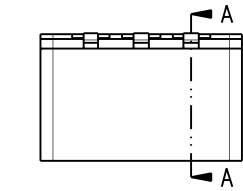

SECTION A-A



Elco Europe (A Division of AVX Ltd) CONFIDENTIAL PROPRIETY
The document on this print and information therewith are PROPRIETY
to Elco Europe (A Division of AVX Ltd) and shall not be copied
or disclosed in whole or in part without Elco Europe's written consent.

PACKING DETAILS



- NOTES :-
1. THROUGH THE BOARD 3 WAY EDGE CARD CONNECTOR.
 2. FOR FURTHER DETAILS REFER TO PRODUCT SPECIFICATION 201-01-136.
 3. FOR MATING PCB EITHER 0.8mm OR 1.6mm THICK. REFER TO SHEET 7 FOR MATING PCB DETAILS.
 4. CONNECTOR TOP MOUNTING ON PCB.
 5. UP TO 0.5mm RAD TO MATCH CONNECTOR PROFILE.
 6. ALL DIMENSIONS ±0.20 UNLESS TOLERANCE SPECIFIED.
 7. INSULATOR :- PA4T, GLASS FILLED, HALOGEN FREE, UL94 V-0, COLOUR REFER TO SHEET 1.
 8. CONTACT :- COPPER ALLOY, NICKEL PLATED WITH GOLD FLASH ON NOSE AND TIN ON TAILS.
 9. BRACKET :- COPPER ALLOY, PLATING, TIN OVER NICKEL.
 10. PACKING IN TAPE AND REEL, 1000 PIECES PER REEL.
 11. CONTACT TAILS COPLANARITY WITHIN 0.10.
 12. REFER TO SHEET 10 FOR MATCHING PROTECTING CAP.
 13. UL REFERENCE E90723.

ELCO EUROPE (A DIVISION OF AVX LTD.) CONFIDENTIAL PROPRIETARY
THE DRAWING ON THIS PRINT AND INFORMATION THEREWITH ARE PROPRIETARY TO ELCO EUROPE (A DIVISION OF AVX LTD.) AND SHALL NOT BE USED OR DISCLOSED IN WHOLE OR IN PART WITHOUT ELCO EUROPE'S WRITTEN CONSENT.

Release No.	102809
History	10.11.2011
	06.01.2012
	12.01.2012
	03.02.2012
	08.02.2012
	08.03.2012
	28.03.2012
	102876
	26.04.2012
	102879
	14.03.2012
	26.06.2012
	24.07.2012

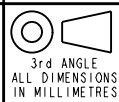

Drawn	N.C.H.	Description	9159 THROUGH BOARD - ORDERING CODE	DATE	06-Jan-12
Size	CV	Part Number	00-9159-01_500S	Issue	6

SHEET 3 OF 10

FORM-106-01-056-6 ISS 7



THROUGH THE BOARD MATING EDGE CARD CONNECTOR - 4 WAY

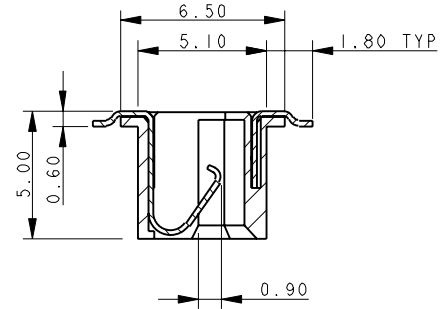
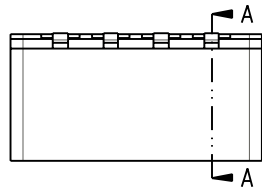

SECTION A-A

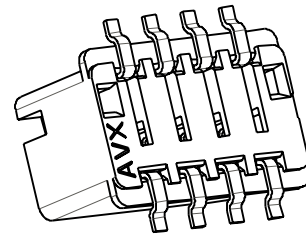
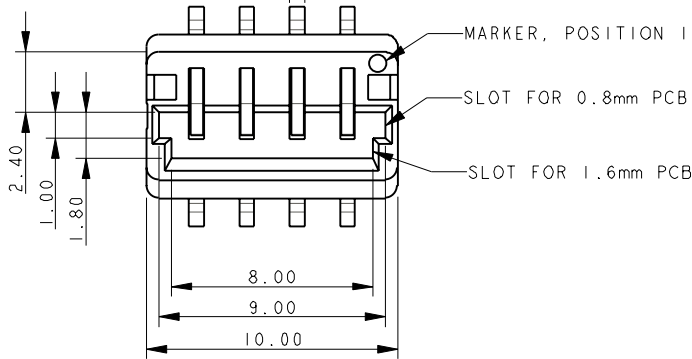

Elco Europe (A Division of AVX Ltd) CONFIDENTIAL PROPRIETY
The document on this print and information therewith are PROPRIETY
to Elco Europe (A Division of AVX Ltd) and shall not be copied
or disclosed in whole or in part without Elco Europe's written consent.

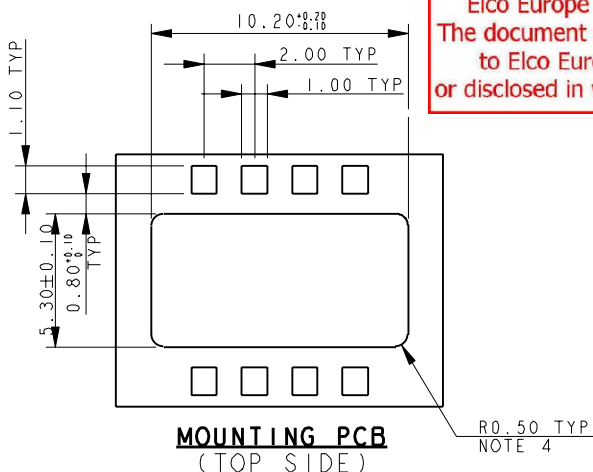

PACKING DETAILS

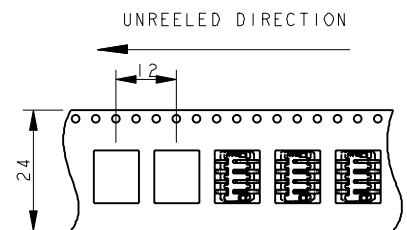
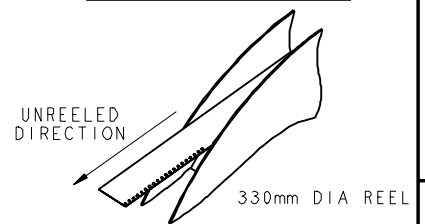

NOTES :-

1. THROUGH THE BOARD 4 WAY EDGE CARD CONNECTOR.
2. FOR FURTHER DETAILS REFER TO PRODUCT SPECIFICATION 201-01-136.
3. FOR MATING PCB EITHER 0.8mm OR 1.6mm THICK. REFER TO SHEET 7 FOR MATING PCB DETAILS.
4. CONNECTOR TOP MOUNTING ON PCB.
5. UP TO 0.5mm RAD TO MATCH CONNECTOR PROFILE.
6. ALL DIMENSIONS ±0.20 UNLESS TOLERANCE SPECIFIED.
7. INSULATOR :- PA4T, GLASS FILLED, HALOGEN FREE, UL94 V-0, COLOUR REFER TO SHEET 1.
8. CONTACT :- COPPER ALLOY, NICKEL PLATED WITH GOLD FLASH ON NOSE AND TIN ON TAILS.
9. BRACKET :- COPPER ALLOY, PLATING, TIN OVER NICKEL.
10. PACKING IN TAPE AND REEL, 1000 PIECES PER REEL.
11. CONTACT TAILS COPLANARITY WITHIN 0.10.
12. REFER TO SHEET 10 FOR MATCHING PROTECTING CAP.
13. UL REFERENCE E90723.

ELCO EUROPE (A DIVISION OF AVX LTD.) CONFIDENTIAL PROPRIETARY
THE DRAWING ON THIS PRINT AND INFORMATION THEREWITH ARE PROPRIETARY TO ELCO EUROPE (A DIVISION OF AVX LTD.) AND SHALL NOT BE USED OR DISCLOSED IN WHOLE OR IN PART WITHOUT ELCO EUROPE'S WRITTEN CONSENT.

Release No.	102809
History	10.11.2011
	06.01.2012
	12.01.2012
	03.02.2012
	08.02.2012
	08.03.2012
	28.03.2012
	102876
	26.04.2012
	102879
	14.03.2012
	15.03.2012
	26.06.2012
	24.07.2012

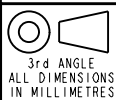

Drawn	N.C.H.
Size	CV

Description	9159 THROUGH BOARD - ORDERING CODE
Part Number	00-9159-01_500S

DATE	06-Jan-12
Issue	6



THROUGH THE BOARD MATING EDGE CARD CONNECTOR - 5 WAY

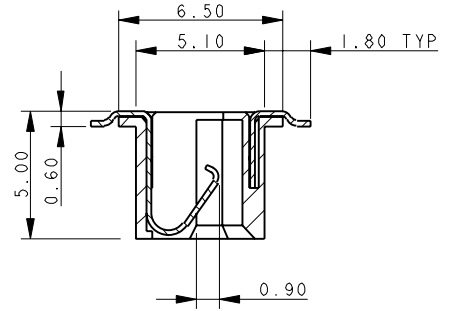
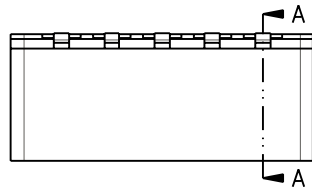

SECTION A-A

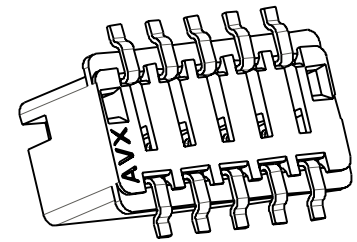
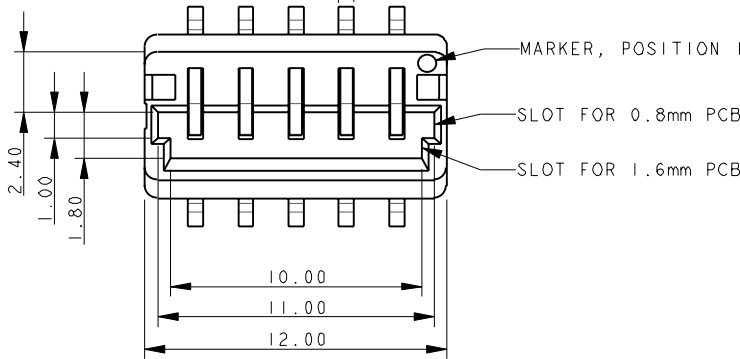

Elco Europe (A Division of AVX Ltd) CONFIDENTIAL PROPRIETY
The document on this print and information therewith are PROPRIETY
to Elco Europe (A Division of AVX Ltd) and shall not be copied
or disclosed in whole or in part without Elco Europe's written consent.

PACKING DETAILS

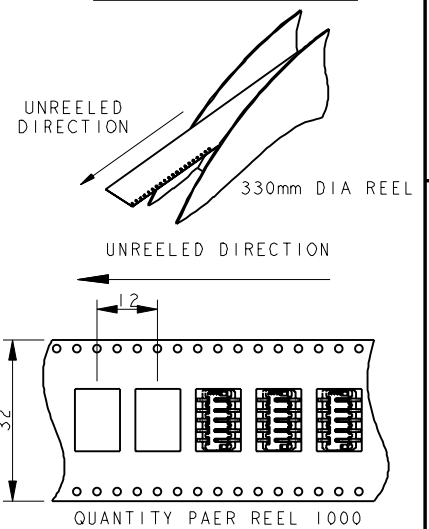

NOTES :-

1. THROUGH THE BOARD 5 WAY EDGE CARD CONNECTOR. FOR FURTHER DETAILS REFER TO PRODUCT SPECIFICATION 201-01-136.
2. FOR MATING PCB EITHER 0.8mm OR 1.6mm THICK. REFER TO SHEET 7 FOR MATING PCB DETAILS.
3. CONNECTOR TOP MOUNTING ON PCB.
4. UP TO 0.5mm RAD TO MATCH CONNECTOR PROFILE.
5. ALL DIMENSIONS ±0.20 UNLESS TOLERANCE SPECIFIED.
6. INSULATOR :- PA4T, GLASS FILLED, HALOGEN FREE, UL94 V-0, COLOUR REFER TO SHEET 1.
7. CONTACT :- COPPER ALLOY, NICKEL PLATED WITH GOLD FLASH ON NOSE AND TIN ON TAILS.
8. BRACKET :- COPPER ALLOY, PLATING, TIN OVER NICKEL.
9. PACKING IN TAPE AND REEL, 1000 PIECES PER REEL.
10. CONTACT TAILS COPLANARITY WITHIN 0.10.
11. REFER TO SHEET 10 FOR MATCHING PROTECTING CAP.
12. UL REFERENCE E90723.

FORM-106-01-056-6 ISS 7

ELCO EUROPE (A DIVISION OF AVX LTD.) CONFIDENTIAL PROPRIETY
THE DRAWING ON THIS PRINT AND INFORMATION THEREWITH ARE PROPRIETARY TO ELCO EUROPE (A DIVISION OF AVX LTD.) AND SHALL NOT BE USED OR DISCLOSED IN WHOLE OR IN PART WITHOUT ELCO EUROPE'S WRITTEN CONSENT.

Release No.	History
102809	10.11.2011
	06.01.2012
	12.01.2012
	03.02.2012
	08.02.2012
	08.03.2012
	28.03.2012
	102876
	26.04.2012
	102879
	14.03.2012
	26.06.2012
	24.07.2012

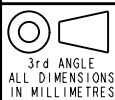

Drawn N.C.H.	Description 9159 THROUGH BOARD - ORDERING CODE	DATE 06-Jan-12
Size CV	Part Number 00-9159-01_500S	Issue 6

SHEET 5 OF 10

A

B



THROUGH THE BOARD MATING EDGE CARD CONNECTOR - 6 WAY

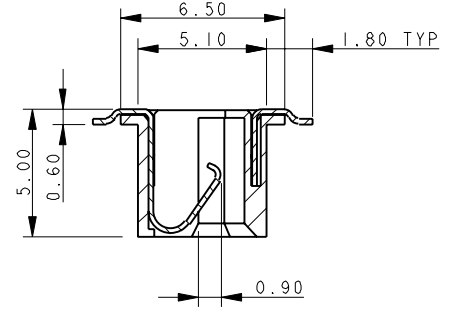
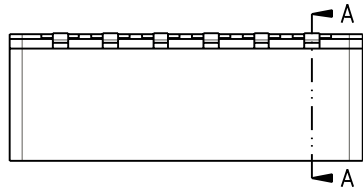

SECTION A-A

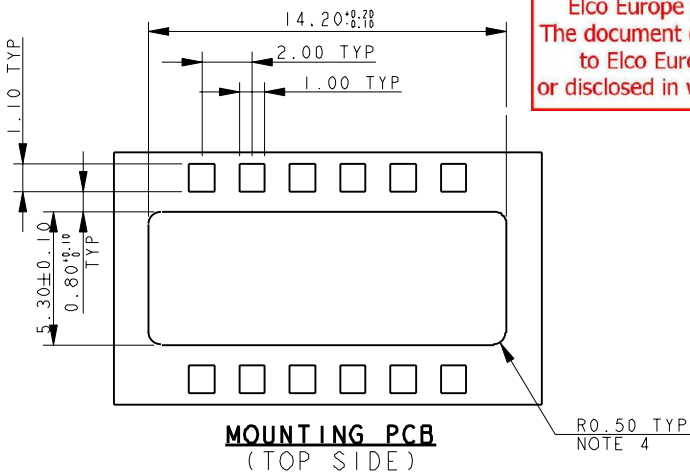
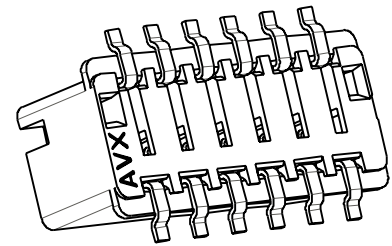
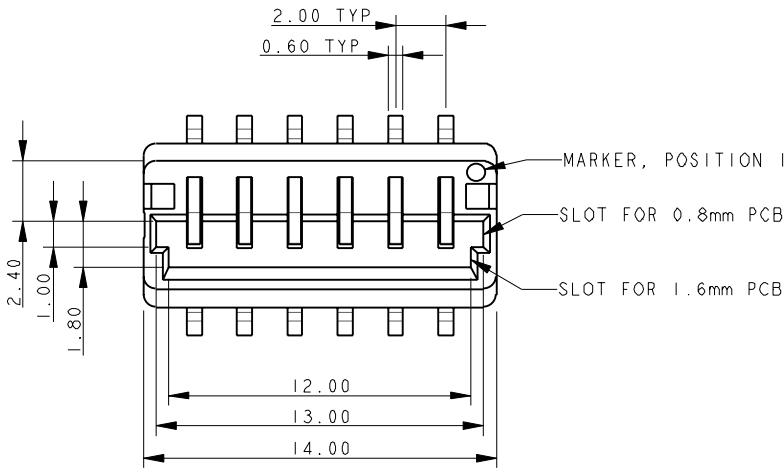

Elco Europe (A Division of AVX Ltd) CONFIDENTIAL PROPRIETY
The document on this print and information therewith are PROPRIETY
to Elco Europe (A Division of AVX Ltd) and shall not be copied
or disclosed in whole or in part without Elco Europe's written consent.

PACKING DETAILS

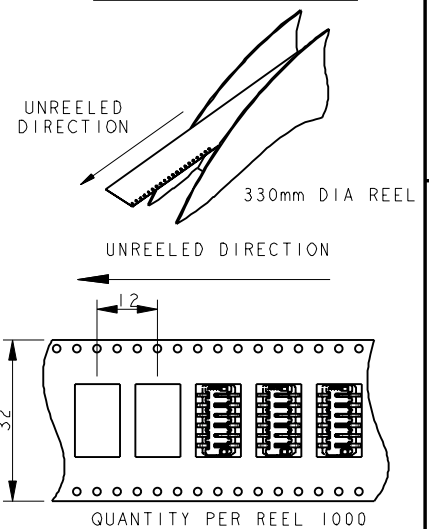

NOTES :-

1. THROUGH THE BOARD 6 WAY EDGE CARD CONNECTOR.
2. FOR FURTHER DETAILS REFER TO PRODUCT SPECIFICATION 201-01-136.
3. FOR MATING PCB EITHER 0.8mm OR 1.6mm THICK. REFER TO SHEET 7 FOR MATING PCB DETAILS.
4. CONNECTOR TOP MOUNTING ON PCB.
5. UP TO 0.5mm RAD TO MATCH CONNECTOR PROFILE.
6. ALL DIMENSIONS ±0.20 UNLESS TOLERANCE SPECIFIED.
7. INSULATOR :- PA4T, GLASS FILLED, HALOGEN FREE, UL94 V-0, COLOUR REFER TO SHEET 1.
8. CONTACT :- COPPER ALLOY, NICKEL PLATED WITH GOLD FLASH ON NOSE AND TIN ON TAILS.
9. BRACKET :- COPPER ALLOY, PLATING, TIN OVER NICKEL.
10. PACKING IN TAPE AND REEL, 1000 PICES PER REEL.
11. CONTACT TAILS COPLANARITY WITHIN 0.10.
12. REFER TO SHEET 10 FOR MATCHING PROTECTING CAP.
13. UL REFERENCE E90723.

ELCO EUROPE (A DIVISION OF AVX LTD.) CONFIDENTIAL PROPRIETARY
THE DRAWING ON THIS PRINT AND INFORMATION THEREWITH ARE PROPRIETARY TO ELCO EUROPE (A DIVISION OF AVX LTD.) AND SHALL NOT BE USED OR DISCLOSED IN WHOLE OR IN PART WITHOUT ELCO EUROPE'S WRITTEN CONSENT.

Release No.	History
102809	10.11.2011
102810	06.01.2012
102811	12.01.2012
102812	08.02.2012
102813	08.03.2012
102814	28.03.2012
102815	26.04.2012
102816	10.05.2012
102817	14.05.2012
102818	15.06.2012
102819	26.06.2012
102820	24.07.2012

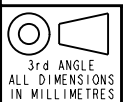

Drawn	N.C.H.	Description	6159 THROUGH BOARD - ORDERING CODE	DATE	06-Jan-12
Size	CV	Part Number	00-9159-01_500S	Issue	6

FORM-106-01-056-6 ISS 7

THROUGH THE BOARD MATING EDGE CARD CONNECTOR - WITH CAP
00-9159-00X-502-X06

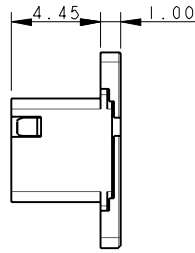
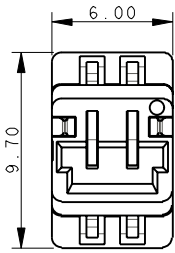

00-9159-002-502-906

Elco Europe (A Division of AVX Ltd) CONFIDENTIAL PROPRIETY
 The document on this print and information therewith are PROPRIETY
 to Elco Europe (A Division of AVX Ltd) and shall not be copied
 or disclosed in whole or in part without Elco Europe's written consent.

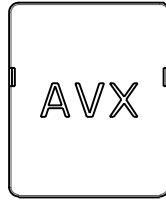
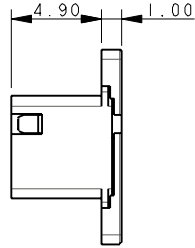
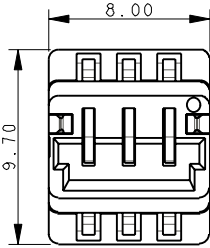

00-9159-003-502-906

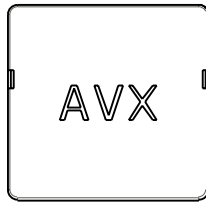
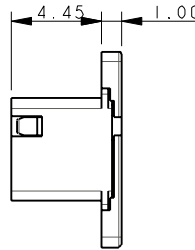
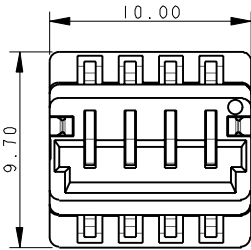

00-9159-004-502-906

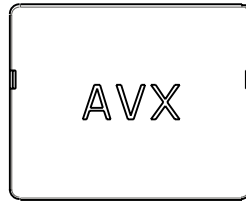
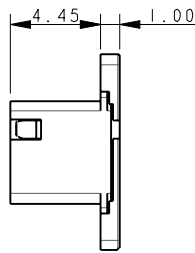
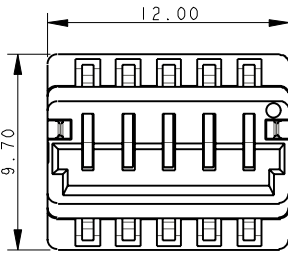

00-9159-005-502-906

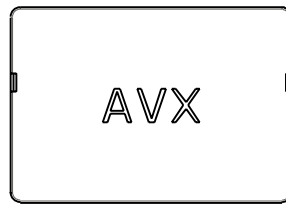
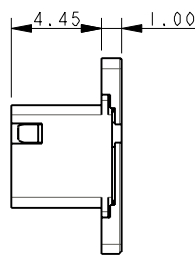
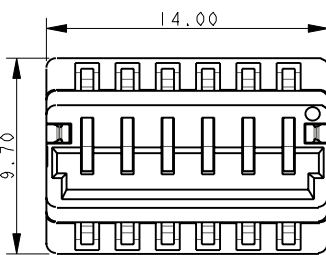

00-9159-006-502-906

- NOTES :-
1. 00-9159-00X-501-X06 WITH CAP SUPPLIED FITTED.
 2. DRAWINGS SHOW OUTLINE DIMENSIONS OF THE 00-9159-00X-502-X06 ASSEMBLIES, ALL OTHER DETAILS ARE AS 00-9159-00X-501-X06 ON SHEETS 2 TO 6.
 3. GENERAL TOLERANCE ±0.20.
 4. PACKING ORIENTATION.
 12. UL REFERENCE E90723.

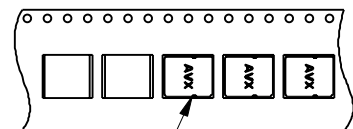

NOTE 4

ELCO EUROPE (A DIVISION OF AVX LTD.) CONFIDENTIAL PROPRIETARY
 THE DRAWING ON THIS PRINT AND INFORMATION THEREWITH ARE PROPRIETARY TO ELCO EUROPE (A DIVISION OF AVX LTD.) AND SHALL NOT BE USED OR DISCLOSED IN WHOLE OR IN PART WITHOUT ELCO EUROPE'S WRITTEN CONSENT.

SHEET 7 OF 10

Release No.	History
102809	03.02.2012
102810	08.02.2012
102811	28.03.2012
102876	26.04.2012
102879	14.05.2012
102880	15.06.2012
102881	26.06.2012
102882	24.07.2012

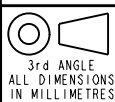

Drawn	N.C.H.
Size	CV

Description	9159 THROUGH BOARD - ORDERING CODE
Part Number	00-9159-01_500S

DATE	06-Jan-12
Issue	6

THROUGH THE BOARD MATING EDGE CARD CONNECTOR - MATING PCB

MATING PCB - 0.8mm PCB

MATING PCB - 1.6mm PCB



Elco Europe (A Division of AVX Ltd) CONFIDENTIAL PROPRIETY
 The document on this print and information therewith are PROPRIETY
 to Elco Europe (A Division of AVX Ltd) and shall not be copied
 or disclosed in whole or in part without Elco Europe's written consent.

- NOTES :-
1. CORRECT DIMENSIONS FOR EITHER 0.80mm OR 1.60mm PCB THICKNESS MUST BE USED.
 2. THICKNESS OF PCB INCLUDES ALL LAYERS INCLUDING COPPER AND PLATING.
 3. PADS TO BE PLATED GOLD OVER NICKEL UNDERCOAT.
 4. GENERAL TOLERANCE ±0.10 UNLESS STATED.



ELCO EUROPE (A DIVISION OF AVX LTD.) CONFIDENTIAL PROPRIETY
 THE DRAWING ON THIS PRINT AND INFORMATION THEREWITH ARE PROPRIETY TO ELCO EUROPE (A DIVISION OF AVX LTD.) AND SHALL NOT BE USED OR DISCLOSED IN WHOLE OR IN PART WITHOUT ELCO EUROPE'S WRITTEN CONSENT.

SHEET 8 OF 10

Release No.	102809
History	10.11.2011
	06.01.2012
	12.01.2012
	03.02.2012
	08.02.2012
	28.03.2012
	102876
	26.04.2012
	102879
	14.03.2012
	15.03.2012
	26.06.2012
	24.07.2012

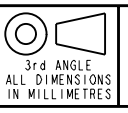

Drawn	N.C.H.	Description	9159 THROUGH BOARD - ORDERING CODE	DATE	06-Jan-12
Size	CV	Part Number	00-9159-01_500S	Issue	6

A

B



THROUGH THE BOARD MATING EDGE CARD CONNECTOR

Elco Europe (A Division of AVX Ltd) CONFIDENTIAL PROPRIETY
The document on this print and information therewith are PROPRIETY
to Elco Europe (A Division of AVX Ltd) and shall not be copied
or disclosed in whole or in part without Elco Europe's written consent.

CONNECTOR/PCB ASSEMBLY
0.8mm MATING PCB
NO CAP

CONNECTOR/PCB ASSEMBLY
1.6mm MATING PCB
WITH CAP

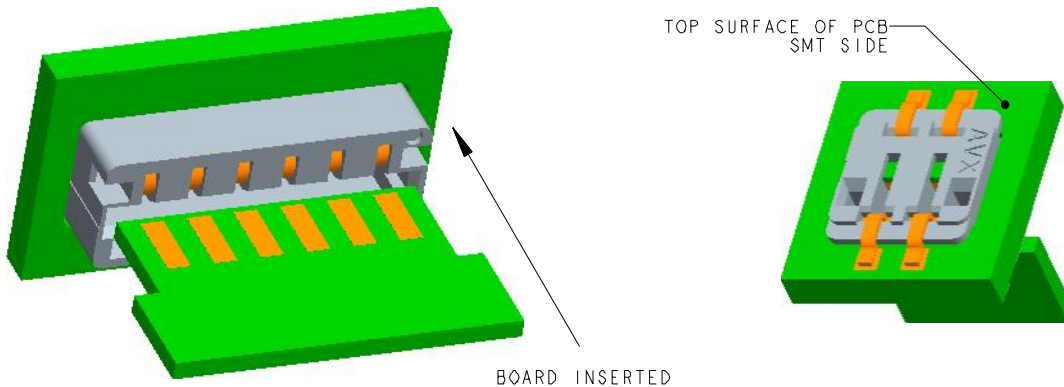
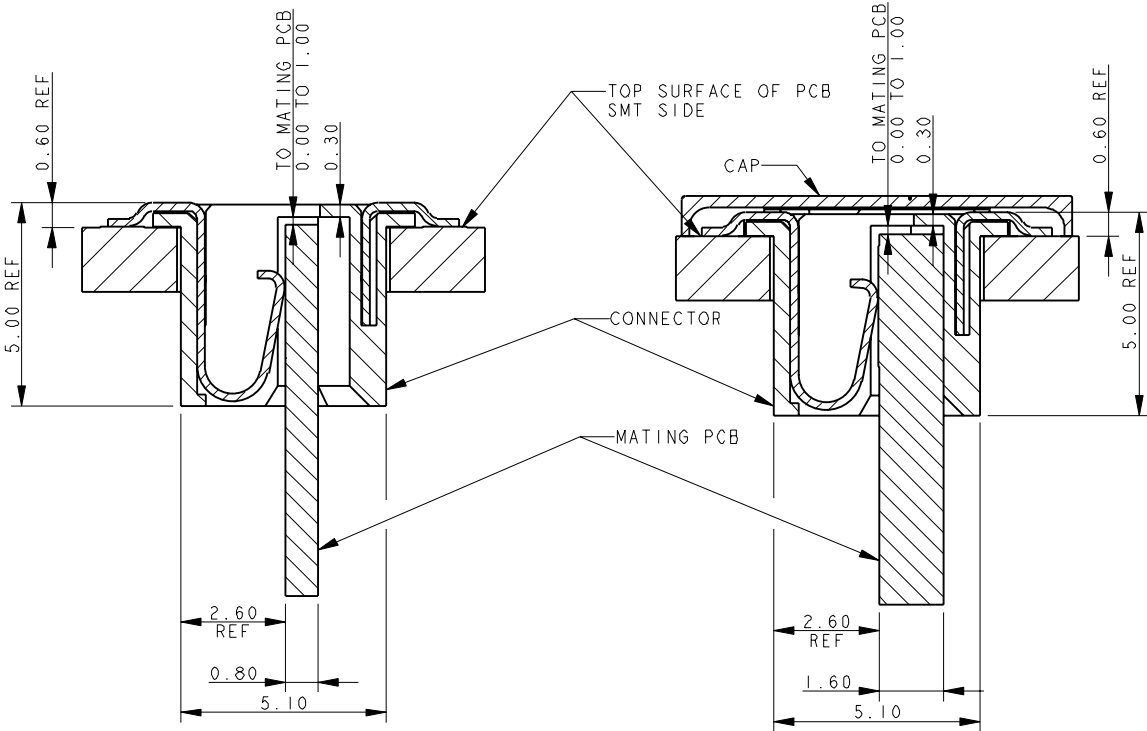

NOTES :-

1. THROUGH THE BOARD EDGE CARD CONNECTOR.
2. FOR MATING PCB EITHER 0.8mm OR 1.6mm THICK. REFER TO SHEET 7 FOR MATING PCB DETAILS.
3. CONNECTOR TOP MOUNTING ON PCB.
4. PAD DETAILS ON THE MATING PCB ALLOW CONTACT TO BE MADE IN ANY POSITION FROM THE STOP FACE UP TO 1mm FROM THE STOP FACE.
5. GENERAL TOLERANCE ± 0.20 UNLESS STATED.

ELCO EUROPE (A DIVISION OF AVX LTD.) CONFIDENTIAL PROPRIETY
 THE DRAWING ON THIS PRINT AND INFORMATION THEREWITH ARE PROPRIETARY TO ELCO EUROPE (A DIVISION OF AVX LTD.) AND SHALL NOT BE USED OR DISCLOSED IN WHOLE OR IN PART WITHOUT ELCO EUROPE'S WRITTEN CONSENT.

SHEET 9 OF 10

Release No.	102809
History	10.11.2011
	06.01.2012
	12.01.2012
	03.02.2012
	08.02.2012
	28.03.2012
	102876
	26.04.2012
	102879
	14.05.2012
	26.06.2012
	24.07.2012

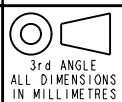

Drawn
N.C.H.
Size
CV

Description
9159 THROUGH BOARD - ORDERING CODE
Part Number
00-9159-01_500S

DATE
06-Jan-12
Issue
6

A

B



ACCESSORY - PROTECTING CAP

Elco Europe (A Division of AVX Ltd) CONFIDENTIAL PROPRIETY
 The document on this print and information therewith are PROPRIETY
 to Elco Europe (A Division of AVX Ltd) and shall not be copied
 or disclosed in whole or in part without Elco Europe's written consent.



2 WAY
60-9159-3502-09-000

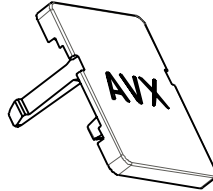
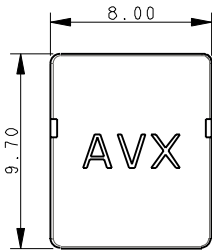

3 WAY
60-9159-3503-09-000

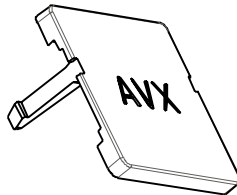
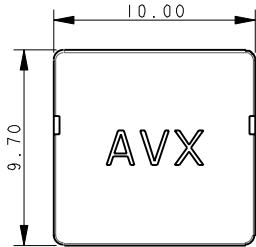

4 WAY
60-9159-3504-09-000

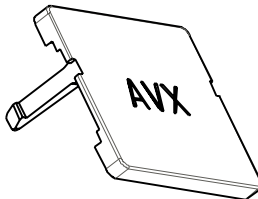

5 WAY
60-9159-350-09-000

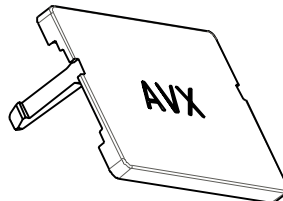

6 WAY
60-9159-3506-09-000

- NOTES :-
 1. PROTECTING CAP, ACCESSORY, NOT SUPPLIED WITH CONNECTOR.
 2. CLIPS TO TOP OF CONNECTOR TO COVER ALL METAL COMPONENTS.
 3. MATERIAL :- PA4T, GLASS FILLED, HALOGEN FREE, UL94 V-0,
 COLOUR CODE REFER TO SHEET 1, "X" IN PART NUMBER.
 4. SUPPLIED IN BAGS OF 1000 PIECES.
 5. GENERAL TOLERANCE ± 0.20 .
 12. UL REFERENCE E90723.



ASSEMBLED CAP

SHEET 10 OF 10

ELCO EUROPE (A DIVISION OF AVX LTD.) CONFIDENTIAL PROPRIETY
 THE DRAWING ON THIS PRINT AND INFORMATION THEREWITH ARE
 PROPRIETARY TO ELCO EUROPE (A DIVISION OF AVX LTD.) AND
 SHALL NOT BE USED OR DISCLOSED IN WHOLE OR IN PART
 WITHOUT ELCO EUROPE'S WRITTEN CONSENT.

Release No.	102809
History	10.11.2011
	06.01.2012
	12.01.2012
	03.02.2012
	08.02.2012
	08.03.2012
	28.03.2012
	102876
	26.04.2012
	102879
	14.03.2012
	15.03.2012
	26.06.2012
	24.07.2012

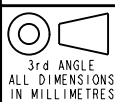

Drawn	N.C.H.
Size	CV

Description	9159 THROUGH BOARD - ORDERING CODE
Part Number	00-9159-01_500S

DATE	06-Jan-12
Issue	6

FORM-106-01-036-6 ISS 7



Компания «ЭлектроПласт» предлагает заключение долгосрочных отношений при поставках импортных электронных компонентов на взаимовыгодных условиях!

Наши преимущества:

- Оперативные поставки широкого спектра электронных компонентов отечественного и импортного производства напрямую от производителей и с крупнейших мировых складов;
- Поставка более 17-ти миллионов наименований электронных компонентов;
- Поставка сложных, дефицитных, либо снятых с производства позиций;
- Оперативные сроки поставки под заказ (от 5 рабочих дней);
- Экспресс доставка в любую точку России;
- Техническая поддержка проекта, помощь в подборе аналогов, поставка прототипов;
- Система менеджмента качества сертифицирована по Международному стандарту ISO 9001;
- Лицензия ФСБ на осуществление работ с использованием сведений, составляющих государственную тайну;
- Поставка специализированных компонентов (Xilinx, Altera, Analog Devices, Intersil, Interpoint, Microsemi, Aeroflex, Peregrine, Syfer, Eurofarad, Texas Instrument, Miteq, Cobham, E2V, MA-COM, Hittite, Mini-Circuits, General Dynamics и др.);

Помимо этого, одним из направлений компании «ЭлектроПласт» является направление «Источники питания». Мы предлагаем Вам помощь Конструкторского отдела:

- Подбор оптимального решения, техническое обоснование при выборе компонента;
- Подбор аналогов;
- Консультации по применению компонента;
- Поставка образцов и прототипов;
- Техническая поддержка проекта;
- Защита от снятия компонента с производства.



Как с нами связаться

Телефон: 8 (812) 309 58 32 (многоканальный)

Факс: 8 (812) 320-02-42

Электронная почта: org@eplast1.ru

Адрес: 198099, г. Санкт-Петербург, ул. Калинина, дом 2, корпус 4, литера А.