

REV	DATE	BY	CHKD	APP'D	DESCRIPTION
13	0024233	MCP	07SEF06	LG	CHECK
12	0018451	SAV	19 JAN 98	DGD	18 JAN 06

**MICRO SWITCH**  
a Honeywell Division  
SOLID STATE SENSOR  
SS5 SERIES CHART 1

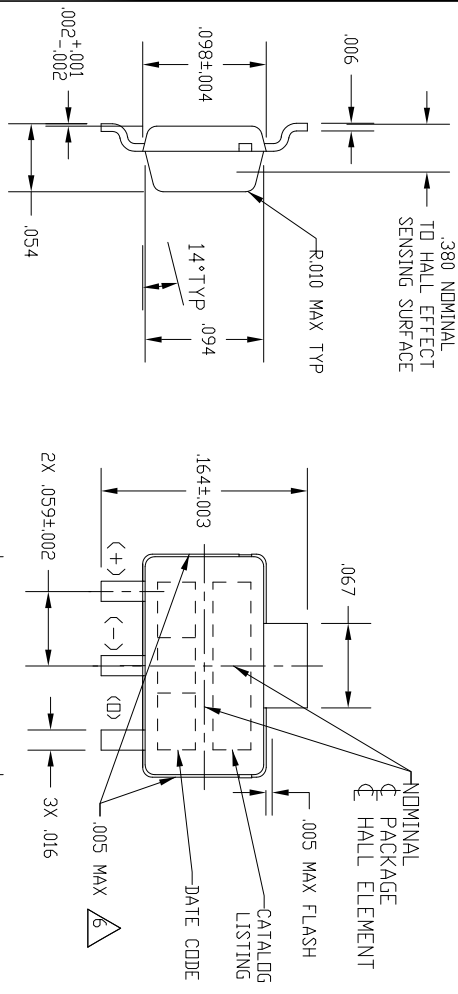

REV	DOCUMENT	CHANGED BY	CHECK
13	0024233	MCP 07SEF06	LG

NOTES  
1 - SOLDERING INSTRUCTIONS: EXPOSURE TO HIGH TEMPERATURES SHOULD BE KEPT AT A MINIMUM MICRO SWITCH RECOMMENDS AN INFRARED REFLOW PROCESS WITH PEAK TEMPERATURES NOT EXCEEDING 245°C (473°F) FOR 10 SECONDS MAXIMUM. DO NOT WAVE SOLDER THIS PRODUCT AS THIS PROCESS MAY NEGATIVELY AFFECT THE SENSOR'S PERFORMANCE AND RELIABILITY. SUBJECTING THESE PRODUCTS TO WAVE SOLDERING WILL VOID MICRO SWITCH'S WARRANTY.

- 2 - ABSOLUTE MAXIMUM RATINGS ARE THE EXTREME LIMITS THE DEVICE WILL MOMENTARILY WITHSTAND WITHOUT DAMAGE TO THE DEVICE. ELECTRICAL AND MAGNETIC CHARACTERISTICS ARE NOT GUARANTEED IF THE SPECIFIED VOLTAGE AND/OR CURRENTS ARE EXCEEDED NDR WILL THE DEVICE NECESSARILY OPERATE AT ABSOLUTE MAXIMUM RATING.
- 3 - THE MAGNETIC FLUX USED TO OPERATE THE SWITCH MUST BE IN THE DIRECTION AND LOCATION SHOWN. (THIS ASSUMES THE CONVENTION THAT THE DIRECTION OF THE EXTERNAL FLUX OF A MAGNET IS FROM THE NORTH TO THE SOUTH POLE OF THE MAGNET.)
- 4 - THE MAGNETIC FIELD STRENGTH (GAUSS) REQUIRED TO CAUSE THE SWITCH TO CHANGE STATE (OPERATE AND RELEASE) WILL BE AS SPECIFIED IN THE MAGNETIC CHARACTERISTICS. TO TEST THE SWITCH AGAINST THE SPECIFIED MAGNETIC CHARACTERISTICS, THE SWITCH MUST BE PLACED IN A UNIFORM MAGNETIC FIELD.
- 5 - A "T" SUFFIX ON ANY CATALOG LISTING DESIGNATES THE PRODUCT WILL BE SUPPLIED IN TAPE AND REEL FORM PER EIA STD 481. SS5 SERIES SHLD IN TAPE AND REEL ONLY. SOME BASIC LISTINGS MAY NOT BE AVAILABLE GATE VESAGE PERMITTED IN THESE AREAS. UNDERFLUSH BREAKOUT LIMITED TO .007.
- 6 - THESE HALL EFFECT SENSORS MAY HAVE AN INITIAL OUTPUT IN EITHER THE ON OR OFF STATE IF POWERED UP WITH AN APPLIED MAGNETIC FIELD IN THE DIFFERENTIAL ZONE (APPLIED MAGNETIC FIELD > BPP AND < BOP). MICRO SWITCH RECOMMENDS THAT THE APPLICATION CIRCUIT DESIGNER ALLOW 10 MICROSECONDS AFTER SUPPLY VOLTAGE HAS REACHED 5 VOLTS FOR THE OUTPUT VOLTAGE TO STABILIZE.
- 7 -

CONVERSION TO METRIC DIMENSIONS			
DIMENSION	IN INCHES	METRIC EQUIVALENT, MM	REFERENCE
.001	0.025	0.025	2.413
.002	0.051	0.051	2.489
.003	0.076	0.076	3.988
.004	0.102	0.102	4.166
.005	0.127	0.127	4.394
.006	0.152	0.152	4.496
.007	0.178	0.178	4.597
.008	0.203	0.203	5.004
.015	0.381	0.381	5.512
.016	0.406	0.406	5.842
.030	0.762	0.762	7.976
.031	0.787	0.787	8.001
.038	0.965	0.965	11.989
.050	1.270	1.270	12.192
.059	1.499	1.499	13.005
.067	1.702	1.702	18.390
.069	1.753	1.753	33.020
.078	1.981	1.981	50.038
.079	2.007	2.007	178.054
.094	2.388	2.388	254.000

THIRD ANGLE PROJECTION
DO NOT SCALE PRINT
SCALE NONE
UNLESS OTHERWISE SPECIFIED TOLERANCES ARE:
DNE PLACE (.00) +0.0 0.3
TWO PLACE (.00) +.015
THREE PLACE (.000) +.005
ANGLES
WEIGHT

**MICRO SWITCH**  
a Honeywell Division  
FED. REG. CODE 91929

SOLID STATE SENSOR

SSS SERIES CHART 1

CATALOG LISTING

THIS DRAWING COVERS A PROPRIETARY ITEM AND IS THE PROPERTY OF MICRO SWITCH, A DIVISION OF HONEYWELL. THIS DRAWING IS NOT TO BE COPIED OR USED WITHOUT THE APPROVAL OF MICRO SWITCH.

CATALOG LISTING  
**SSS SERIES CHART**  
PAGE 2 OF 5

ISSUE  
14

PTC/CAD 3D  
DRAWN  
WJC 5 JAN 98  
CHECK  
SAV 19 JAN 98  
CHECK  
DGD 18 JAN 06  
CHECK

REVISIONS  
B REC'DWG  
C 27 JAN 98  
D 92729  
E 92816  
F 14 JAN 99  
G 1 MAR 99  
H 20747  
I 20747  
J 20814  
K 20746  
L 6 MAR 03  
M 0019451  
N 18 JAN 06

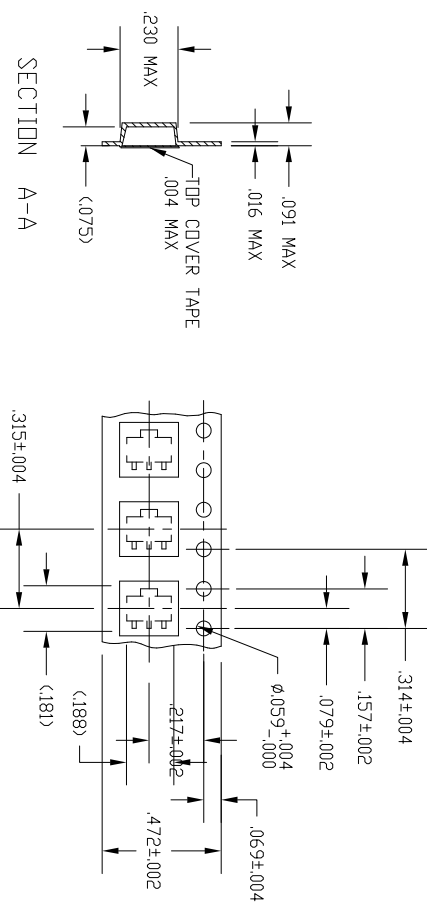

SECTION A-A  
TAPE AND REEL DIMENSIONS

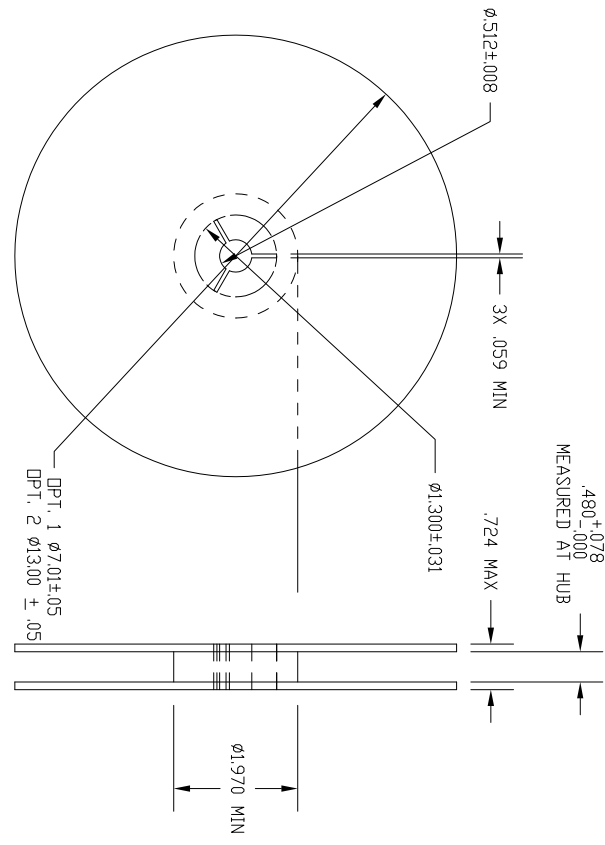

DIRECTION OF FEED FROM REEL  
ANSI Y14.5M-1982 APPLIES

SSS CATALOG SYSTEM

PREFIX  
BASIC CATALOG LISTING:  
PACKAGE STYLE, MAGNETIC TYPE,  
ELECTRICAL/MAGNETIC SPECS

CHARACTERS IN THESE  
POSITIONS OF THE LISTING  
ARE BRANDED ON THE PRODUCT

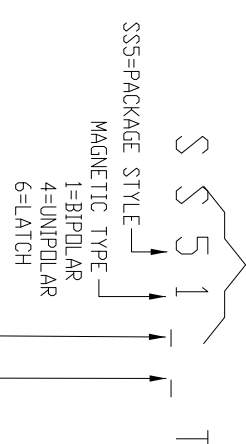

RELATIVE GAUSS OPERATING RANGE  
(BLANK, 0-9, 9=HIGH GAUSS)  
ELECTRICAL/MAGNETIC OPTIONS  
(BLANK, A-K & U-Z)  
A-STANDARD  
B-K & U-Z=SPECIALS



THIRD ANGLE PROJECTION	
SCALE	NONE
DO NOT SCALE PRINT	
UNLESS TOLERANCES SPECIFIED	
TOLERANCES ARE:	
ONE PLACE	.00
TWO PLACE	±.01
THREE PLACE	±.000
ANGLES	±
WEIGHT	

CATALOG LISTING

THIS DRAWING COVERS A PROPRIETARY ITEM AND IS THE PROPERTY OF MICRO SWITCH, A DIVISION OF HONEYWELL. THIS DRAWING IS NOT TO BE COPIED OR USED WITHOUT THE APPROVAL OF MICRO SWITCH.

**TABLE 1 - MAGNETIC SPECIFICATIONS**

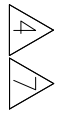

LISTING	-40°C	0°C	25°C	85°C	125°C	150°C
MIN OPERATE GAUSS						
SS511	NS	NS	NS	NS	NS	NS
SS511AT	NS	NS	NS	NS	NS	NS
SS513AT	NS	NS	NS	NS	NS	NS
SS541AT	50	53	55	45	40	35
SS543AT	110	110	110	90	80	65
SS549AT	285	305	310	290	270	260
SS561AT	5	5	10	10	5	5
SS566AT	100	100	100	95	80	70
MAX OPERATE GAUSS						
SS511	145	145	140	150	200	250
SS511AT	70	65	60	60	65	70
SS513AT	140	140	140	140	140	140
SS541AT	135	117	115	120	123	125
SS543AT	215	190	180	180	190	200
SS549AT	435	400	390	400	410	420
SS561AT	110	90	85	85	100	110
SS566AT	200	185	180	180	180	185
MIN RELEASE GAUSS						
SS511	-145	-145	-140	-150	-200	-250
SS511AT	-70	-65	-60	-60	-65	-70
SS513AT	-140	-140	-140	-140	-140	-140
SS541AT	20	20	20	15	15	10
SS543AT	80	80	75	70	60	55
SS549AT	210	230	235	215	200	185
SS561AT	-110	-90	-85	-85	-100	-110
SS566AT	-200	-185	-180	-180	-180	-185
MAX RELEASE GAUSS						
SS511	NS	NS	NS	NS	NS	NS
SS511AT	NS	NS	NS	NS	NS	NS
SS513AT	NS	NS	NS	NS	NS	NS
SS541AT	120	99	95	105	115	120
SS543AT	190	165	155	165	180	195
SS549AT	360	325	315	325	340	345
SS561AT	-5	-5	-10	-10	-5	-5
SS566AT	-100	-100	-100	-95	-80	-70
MIN DIFF GAUSS						
SS511	40	50	50	50	60	NS
SS511AT	15	15	15	12	12	10
SS513AT	20	20	20	20	20	20
SS541AT	15	15	20	15	8	5
SS543AT	25	25	25	15	10	5
SS549AT	30	30	30	30	30	30
SS561AT	50	50	50	50	50	50
SS566AT	200	200	200	190	160	140

**SS5XT ELECTRICAL SPECIFICATIONS**

CHARACTERISTIC	TEST CONDITIONS	UNITS
VOLTAGE RANGE	VCC = 24V, -40°C < T < 150°C, B > MAX DP	4.5 TO 24 VOLTS
MAX I <sub>on</sub>	VCC = 24V, V <sub>out</sub> = 24V, -40°C < T < 150°C, B < MIN REL	100 mA
MAX I <sub>off</sub>	VCC = 24V, V <sub>out</sub> = 24V, -40°C < T < 150°C, B < MIN REL	11.3 mA
SINK CURRENT	VCC = 45V TO 24V, T = 25°C, B > MAX DP	20 mA
MAX V <sub>sat</sub>	VCC = 45V TO 24V, T = 25°C, B > MAX DP	0.4 VOLTS
MAX LEAKAGE	VCC = 12V, R	10 μA
RISE TIME	VCC = 12V, R	1.5 μS
FALL TIME	10% TO 90%	1.5 μS
90% TO 10%	V <sub>ds</sub> = 12V, R	Ω = 20pF

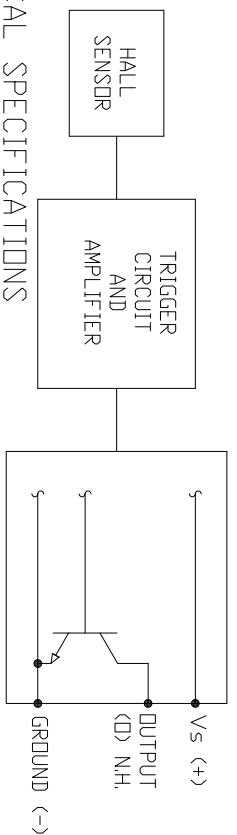

CHARACTERISTIC	TEST CONDITIONS	UNITS
VOLTAGE RANGE	VCC = 30V, -40°C < T < 150°C, B > MAX DP	3.8 TO 30 VOLTS
MAX I <sub>on</sub>	VCC = 30V, V <sub>out</sub> = 30V, -40°C < T < 150°C, B < MIN REL	100 mA
MAX I <sub>off</sub>	VCC = 30V, V <sub>out</sub> = 30V, -40°C < T < 150°C, B < MIN REL	10.0 mA
SINK CURRENT	VCC = 38V, B > MAX DP	20 mA
MAX V <sub>sat</sub>	VCC = 12V, R	0.4 VOLTS
MAX LEAKAGE	VCC = 12V, R	10 μA
RISE TIME	VCC = 12V, R	1.5 μS
FALL TIME	10% TO 90%	1.5 μS
90% TO 10%	V <sub>ds</sub> = 12V, R	Ω = 20pF

**SS5XXAT ELECTRICAL SPECIFICATIONS**

TABLE 2	SS5XX
OUTPUT CURRENT	37
ABSOLUTE LIMITS	33
SUPPLY CURRENT	28
VOLTAGE	24
MAX. mA	19
-1 TO 24	50
24 TO 25	37
25 TO 26	33
26 TO 27	28
27 TO 28	24
28 TO 29	19
29 TO 30	15

CHARACTERISTIC	SYMBOL	MIN	MAX	UNITS
POWER SUPPLY	VCC	-1	30	VOLTS
OUTPUT VOLTAGE (DIF)	V <sub>OUT</sub>		30	VOLTS
OUTPUT ON CURRENT	I <sub>ON</sub>		SEE TABLE	mA
OPERATING TEMPERATURE	T	-50	60	°C
STORAGE TEMPERATURE	T <sub>S</sub>	-65	160	°C
MAGNETIC FLUX	ND LIMIT			

LISTING	TYPE	BRAND
SS511	BIPOLAR	SS51
SS511AT	BIPOLAR	SS11A
SS513AT	BIPOLAR	SS13A
SS541AT	UNIPOLAR	SS41A
SS543AT	UNIPOLAR	SS43A
SS549AT	UNIPOLAR	SS49A
SS561AT	LATCH	SS61A
SS566AT	LATCH	SS66A

ANSI Y14.5M-1982 APPLIES

THIRD ANGLE PROJECTION  
SCALE NONE  
DO NOT SCALE PRINT  
UNLESS OTHERWISE SPECIFIED  
DIMENSIONS ARE  
ONE PLACE (.0) +0.03  
TWO PLACE (.00) +0.15  
THREE PLACE (.000) +0.05  
WEIGHT ANGLES

**MICRO SWITCH**  
a Honeywell Division  
FED. REG. CODE 91929

**SOLID STATE SENSOR**

**SS5 SERIES CHART 1**

CATALOG LISTING

THIS DRAWING COVERS A PROPRIETARY ITEM AND IS THE PROPERTY OF MICRO SWITCH, A DIVISION OF HONEYWELL. THIS DRAWING IS NOT TO BE COPIED OR USED WITHOUT THE APPROVAL OF MICRO SWITCH.

CATALOG LISTING  
**SS5 SERIES CHART**  
PAGE 4 OF 5

ISSUE  
**14**

REVISIONS  
A. REV. Dwg. 27 JUN 98  
B. REV. Dwg. 18 JAN 96  
C. REV. Dwg. 18 JAN 96  
D. REV. Dwg. 18 JAN 96  
E. REV. Dwg. 18 JAN 96  
F. REV. Dwg. 18 JAN 96  
G. REV. Dwg. 18 JAN 96  
H. REV. Dwg. 18 JAN 96

DRAWN: WJC 5 JAN 98  
CHECK: SAV 19 JAN 98  
CHECK: DGD 18 JAN 06  
CHECK: [ ]  
RELEASE NO. DR-4996  
REPLACES: -

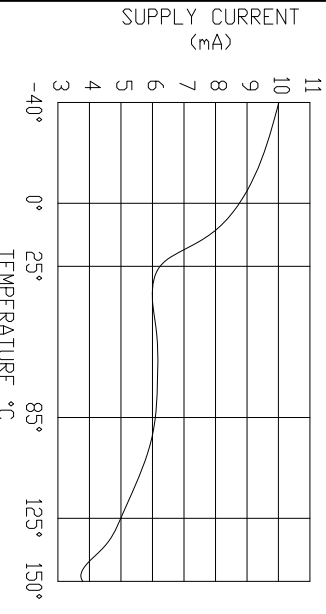

MAXIMUM SUPPLY CURRENT VS TEMPERATURE (OFF)

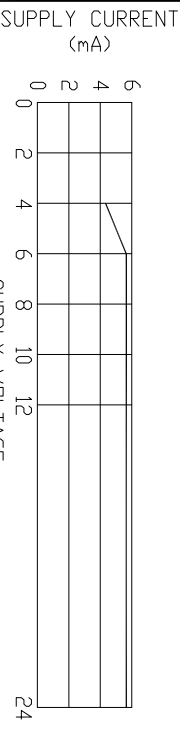

TYPICAL SUPPLY CURRENT (DEVICE OFF) AT 25°C

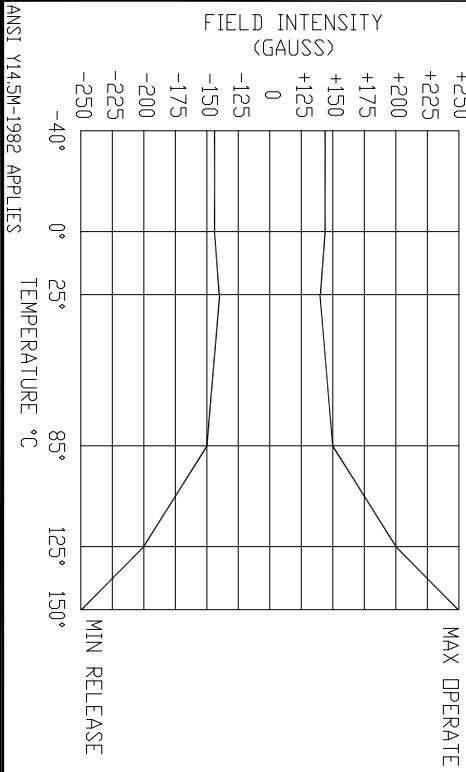

FIELD INTENSITY (GAUSS)

MIN OPERATE  
MAX OPERATE

ANSI Y14.5M-1982 APPLIES

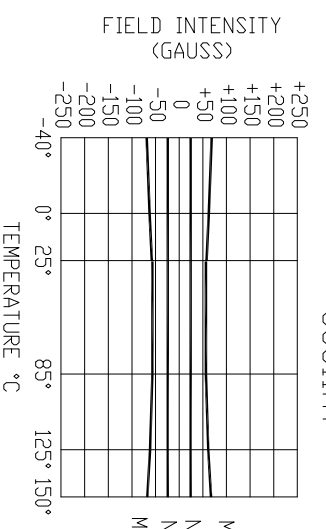

SSS511AT

MAX OPERATE  
NDM OPERATE  
NDM RELEASE  
MIN RELEASE

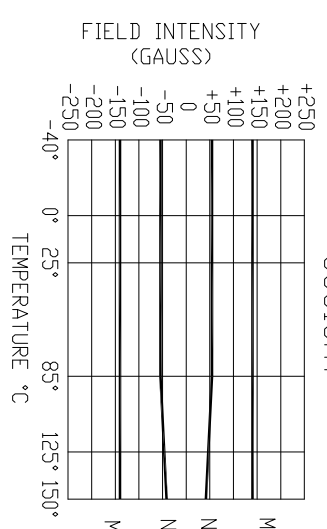

SSS513AT

MAX OPERATE  
NDM OPERATE  
NDM RELEASE  
MIN RELEASE



THIRD ANGLE PROJECTION  
SCALE: NONE  
DO NOT SCALE PRINT  
UNLESS TOLERANCES SPECIFIED  
TOLERANCES ARE:  
ONE PLACE (.00) +0.03  
TWO PLACE (.000) +0.015  
THREE PLACE (.0000) +0.005  
ANGLES ±  
WEIGHT

WJC	5 JAN 98	CHECK	SAV	19 JAN 02	CHECK	DGD	18 JAN 06	CHECK	RELEASE NO.	DR-4996	REPLACES	-
-----	----------	-------	-----	-----------	-------	-----	-----------	-------	-------------	---------	----------	---

**MICRO SWITCH**  
a Honeywell Division  
FED. MFG. CODE 91929

**SOLID STATE SENSOR**

CATALOG LISTING  
**SS5 SERIES CHART 1**

THIS DRAWING COVERS A PROPRIETARY ITEM AND IS THE PROPERTY OF MICRO SWITCH, A DIVISION OF HONEYWELL. THIS DRAWING IS NOT TO BE COPIED OR USED WITHOUT THE APPROVAL OF MICRO SWITCH.

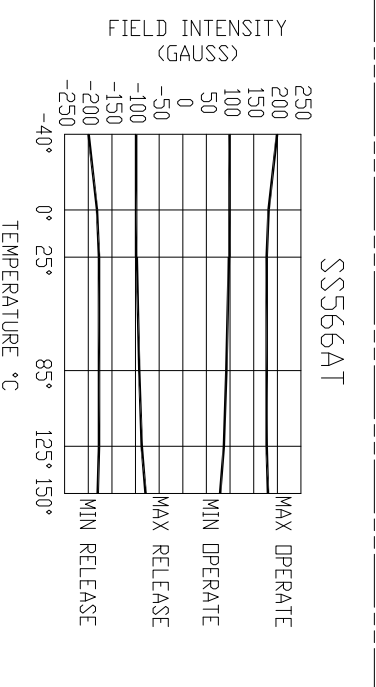
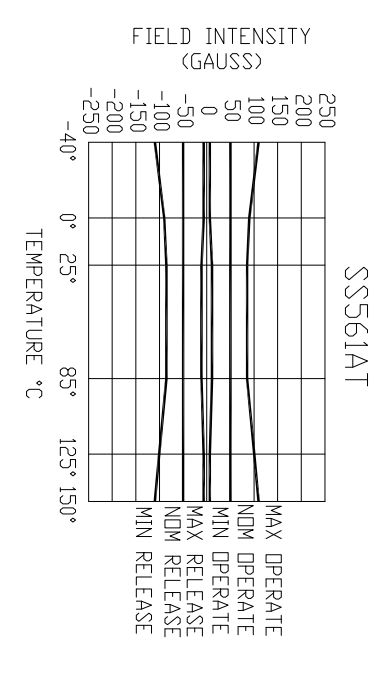
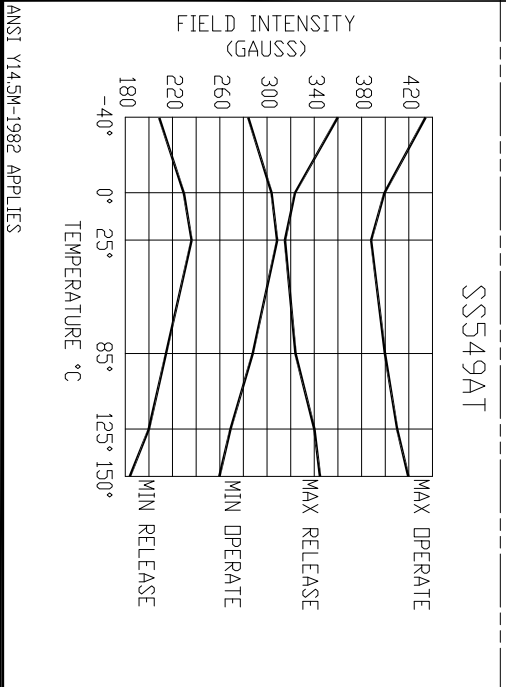
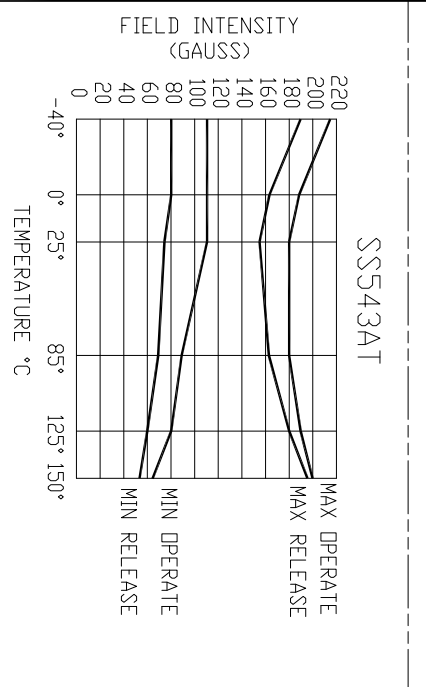
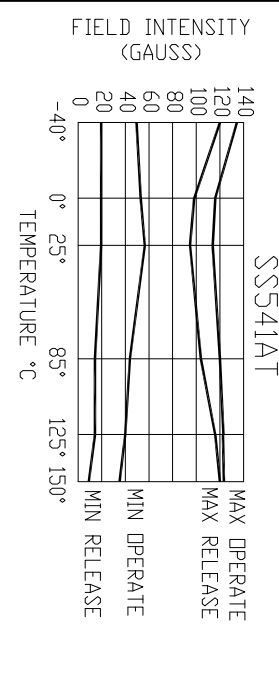

**CAUTION**  
ELECTROSTATIC SENSITIVE DEVICES  
DO NOT SCALE PRINT  
STATE FREE OPERATION

ESD SENSITIVITY:  
CLASS 3

THIRD ANGLE PROJECTION	
SCALE	NONE
DO NOT SCALE PRINT	
UNLESS TOLERANCES SPECIFIED	
ONE PLACE	(.0)
TWO PLACE	(.00)
THREE PLACE	(.000)
ANGLES	(.000) +.005
WEIGHT	



Компания «ЭлектроПласт» предлагает заключение долгосрочных отношений при поставках импортных электронных компонентов на взаимовыгодных условиях!

Наши преимущества:

- Оперативные поставки широкого спектра электронных компонентов отечественного и импортного производства напрямую от производителей и с крупнейших мировых складов;
- Поставка более 17-ти миллионов наименований электронных компонентов;
- Поставка сложных, дефицитных, либо снятых с производства позиций;
- Оперативные сроки поставки под заказ (от 5 рабочих дней);
- Экспресс доставка в любую точку России;
- Техническая поддержка проекта, помощь в подборе аналогов, поставка прототипов;
- Система менеджмента качества сертифицирована по Международному стандарту ISO 9001;
- Лицензия ФСБ на осуществление работ с использованием сведений, составляющих государственную тайну;
- Поставка специализированных компонентов (Xilinx, Altera, Analog Devices, Intersil, Interpoint, Microsemi, Aeroflex, Peregrine, Syfer, Eurofarad, Texas Instrument, Miteq, Cobham, E2V, MA-COM, Hittite, Mini-Circuits, General Dynamics и др.);

Помимо этого, одним из направлений компании «ЭлектроПласт» является направление «Источники питания». Мы предлагаем Вам помощь Конструкторского отдела:

- Подбор оптимального решения, техническое обоснование при выборе компонента;
- Подбор аналогов;
- Консультации по применению компонента;
- Поставка образцов и прототипов;
- Техническая поддержка проекта;
- Защита от снятия компонента с производства.



#### Как с нами связаться

**Телефон:** 8 (812) 309 58 32 (многоканальный)

**Факс:** 8 (812) 320-02-42

**Электронная почта:** [org@eplast1.ru](mailto:org@eplast1.ru)

**Адрес:** 198099, г. Санкт-Петербург, ул. Калинина, дом 2, корпус 4, литера А.