

## 50 mA, 100 mA and 150 mA Adjustable CMOS LDOs with Shutdown

### Features:

- 50  $\mu$ A Ground Current for Longer Battery Life
- Adjustable Output Voltage
- Very Low Dropout Voltage
- Choice of 50 mA (TC1070), 100 mA (TC1071) and 150 mA (TC1187) Output
- Power-Saving Shutdown mode
- Overcurrent and Overtemperature Protection
- Space-Saving 5-Pin SOT-23 Package
- Pin Compatible with Bipolar Regulators

### Applications:

- Battery Operated Systems
- Portable Computers
- Medical Instruments
- Instrumentation
- Cellular/GSM/PHS Phones
- Linear Post-Regulators for SMPS
- Pagers

### Description:

The TC1070, TC1071 and TC1187 devices are adjustable LDOs designed to supersede a variety of older (bipolar) voltage regulators. Total supply current is typically 50  $\mu$ A at full load (20 to 60 times lower than in bipolar regulators).

The devices' key features include ultra low-noise operation, very low dropout voltage – typically 85 mV (TC1070), 180 mV (TC1071) and 270 mV (TC1187) at full load and fast response to step changes in load. Supply current is reduced to 0.5  $\mu$ A (maximum) when the shutdown input is low. The devices incorporate both overtemperature and overcurrent protection. Output voltage is programmed with a simple resistor divider from  $V_{OUT}$  to ADJ to GND.

The TC1070, TC1071 and TC1187 devices are stable with an output capacitor of only 1  $\mu$ F and have a maximum output current of 50 mA, 100 mA and 150 mA, respectively. For higher output versions please see the TC1174 ( $I_{OUT} = 300$  mA) data sheet (DS21363).

### Typical Application

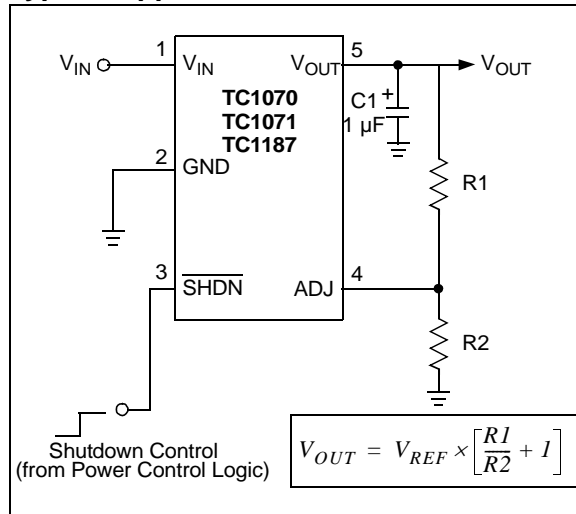

### Package Type

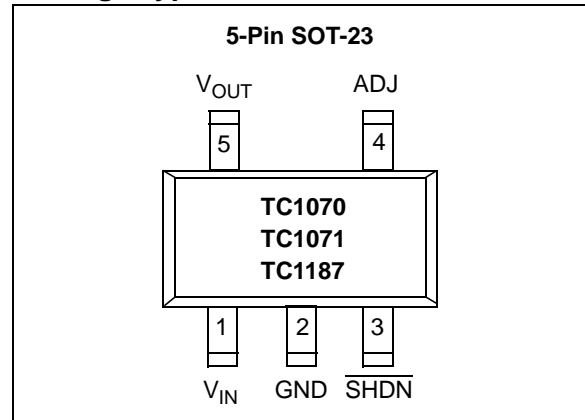

# TC1070/TC1071/TC1187

## 1.0 ELECTRICAL CHARACTERISTICS

### Absolute Maximum Ratings†

Input Voltage .....6.5V  
 Output Voltage..... (-0.3V) to (V<sub>IN</sub> + 0.3V)  
 Power Dissipation.....Internally Limited (**Note 5**)  
 Maximum Voltage on Any Pin ..... V<sub>IN</sub> +0.3V to -0.3V  
 Operating Temperature Range..... -40°C < T<sub>J</sub> < 125°C  
 Storage Temperature..... -65°C to +150°C

† **Notice:** Stresses above those listed under "Absolute Maximum Ratings" may cause permanent damage to the device. These are stress ratings only and functional operation of the device at these or any other conditions above those indicated in the operation sections of the specifications is not implied. Exposure to Absolute Maximum Rating conditions for extended periods may affect device reliability.

### ELECTRICAL SPECIFICATIONS

| <b>Electrical Characteristics:</b> V <sub>IN</sub> = V <sub>OUT</sub> + 1V, I <sub>L</sub> = 0.1 mA, C <sub>L</sub> = 3.3 μF, $\overline{\text{SHDN}} > V_{IH}$ , T <sub>A</sub> = +25°C, unless otherwise noted. <b>Boldface</b> type specifications apply for junction temperatures of -40°C to +125°C. |                                     |                  |           |              |        |   |
|---|-------------------------------------|------------------|-----------|--------------|--------|---|
| Parameter   | Symbol                              | Min              | Typ       | Max          | Units  | Test Conditions   |
| Input Operating Voltage   | V <sub>IN</sub>                     | <b>2.7</b>       | —         | 6.0          | V      | <b>Note 6</b>   |
| Maximum Output Current  | I <sub>OUTmax</sub>                 | <b>50</b>        | —         | —            | mA     | <b>TC1070</b>   |
|   |                                     | <b>100</b>       | —         | —            |        | <b>TC1071</b>   |
|   |                                     | <b>150</b>       | —         | —            |        | <b>TC1187</b>   |
| Adjustable Output Voltage Range   | V <sub>OUT</sub>                    | V <sub>REF</sub> | —         | 5.5          | V      |   |
| Reference Voltage   | V <sub>REF</sub>                    | <b>1.165</b>     | 1.20      | <b>1.235</b> | V      |   |
| V <sub>REF</sub> Temperature Coefficient  | ΔV <sub>REF</sub> /ΔT               | —                | <b>40</b> | —            | ppm/°C | <b>Note 1</b>   |
| Line Regulation   | ΔV <sub>OUT</sub> /ΔV <sub>IN</sub> | —                | 0.05      | <b>0.35</b>  | %      | (V <sub>R</sub> + 1V) ≤ V <sub>IN</sub> ≤ 6V                            |
| Load Regulation ( <b>Note 2</b> )   | ΔV <sub>OUT</sub> /V <sub>OUT</sub> | —                | 0.5       | <b>2</b>     | %      | <b>TC1070, TC1071</b><br>I <sub>L</sub> = 0.1 mA to I <sub>OUTmax</sub> |
|   |                                     | —                | 0.5       | <b>3</b>     |        | <b>TC1187</b><br>I <sub>L</sub> = 0.1 mA to I <sub>OUTmax</sub>         |

**Note 1:** 
$$TC V_{OUT} = \frac{(V_{OUTmax} - V_{OUTmin})}{V_{OUT}} \times 10^6$$

- 2: Regulation is measured at a constant junction temperature using low duty cycle pulse testing. Load regulation is tested over a load range from 0.1 mA to the maximum specified output current. Changes in output voltage due to heating effects are covered by the thermal regulation specification.
- 3: Dropout voltage is defined as the input to output differential at which the output voltage drops 2% below its nominal value.
- 4: Thermal Regulation is defined as the change in output voltage at a time T after a change in power dissipation is applied, excluding load or line regulation effects. Specifications are for a current pulse equal to I<sub>lmax</sub> at V<sub>IN</sub> = 6V for T = 10 ms.
- 5: The maximum allowable power dissipation is a function of ambient temperature, the maximum allowable junction temperature and the thermal resistance from junction-to-air (i.e., T<sub>a</sub>, T<sub>j</sub>, θ<sub>ja</sub>). Exceeding the maximum allowable power dissipation causes the device to initiate thermal shutdown. Please see **Section 5.0 "Thermal Considerations"** for more details.
- 6: The minimum V<sub>IN</sub> has to justify the conditions: V<sub>IN</sub> ≥ V<sub>R</sub> + V<sub>DROPOUT</sub> and V<sub>IN</sub> ≥ 2.7V for I<sub>L</sub> = 0.1 mA to I<sub>OUTMAX</sub>.

# TC1070/TC1071/TC1187

## ELECTRICAL SPECIFICATIONS (CONTINUED)

**Electrical Characteristics:**  $V_{IN} = V_{OUT} + 1V$ ,  $I_L = 0.1 \text{ mA}$ ,  $C_L = 3.3 \mu\text{F}$ ,  $\overline{\text{SHDN}} > V_{IH}$ ,  $T_A = +25^\circ\text{C}$ , unless otherwise noted. **Boldface** type specifications apply for junction temperatures of  $-40^\circ\text{C}$  to  $+125^\circ\text{C}$ .

| Parameter                        | Symbol                        | Min       | Typ  | Max       | Units                  | Test Conditions                                 |
|----------------------------------|-------------------------------|-----------|------|-----------|------------------------|---|
| Dropout Voltage (Note 3)         | $V_{IN} - V_{OUT}$            | —         | 2    | —         | mV                     | $I_L = 0.1 \text{ mA}$                          |
|                                  |                               | —         | 65   | —         |                        | $I_L = 20 \text{ mA}$                           |
|                                  |                               | —         | 85   | 120       |                        | $I_L = 50 \text{ mA}$                           |
|                                  |                               | —         | 180  | 250       |                        | <b>TC1071, TC1187</b><br>$I_L = 100 \text{ mA}$ |
|                                  |                               | —         | 270  | 400       |                        | <b>TC1187</b><br>$I_L = 150 \text{ mA}$         |
| Supply Current                   | $I_{IN}$                      | —         | 50   | 80        | $\mu\text{A}$          | $\overline{\text{SHDN}} = V_{IH}$ , $I_L = 0$   |
| Shutdown Supply Current          | $I_{INSD}$                    | —         | 0.05 | 0.5       | $\mu\text{A}$          | $\overline{\text{SHDN}} = 0V$                   |
| Power Supply Rejection Ratio     | PSRR                          | —         | 64   | —         | dB                     | $F_{RE} \leq 1 \text{ kHz}$                     |
| Output Short Circuit Current     | $I_{OUTSC}$                   | —         | 300  | 450       | mA                     | $V_{OUT} = 0V$                                  |
| Thermal Regulation               | $\Delta V_{OUT} / \Delta P_D$ | —         | 0.04 | —         | V/W                    | Note 4  |
| Thermal Shutdown Die Temperature | $T_{SD}$                      | —         | 160  | —         | $^\circ\text{C}$       |   |
| Thermal Shutdown Hysteresis      | $\Delta T_{SD}$               | —         | 10   | —         | $^\circ\text{C}$       |   |
| Output Noise                     | eN                            | —         | 260  | —         | nV/ $\sqrt{\text{Hz}}$ | $I_L = I_{OUTmax}$                              |
| <b>SHDN Input</b>                |                               |           |      |           |                        |   |
| SHDN Input High Threshold        | $V_{IH}$                      | <b>45</b> | —    | —         | $\%V_{IN}$             | $V_{IN} = 2.5V$ to $6.5V$                       |
| SHDN Input Low Threshold         | $V_{IL}$                      | —         | —    | <b>15</b> | $\%V_{IN}$             | $V_{IN} = 2.5V$ to $6.5V$                       |
| <b>ADJ Input</b>                 |                               |           |      |           |                        |   |
| Adjust Input Leakage Current     | $I_{ADJ}$                     | —         | 50   | —         | pA                     |   |

**Note 1:** 
$$TC \ V_{OUT} = \frac{(V_{OUTmax} - V_{OUTmin}) \times 10^6}{V_{OUT} \times \Delta T}$$

- Regulation is measured at a constant junction temperature using low duty cycle pulse testing. Load regulation is tested over a load range from 0.1 mA to the maximum specified output current. Changes in output voltage due to heating effects are covered by the thermal regulation specification.
- Dropout voltage is defined as the input to output differential at which the output voltage drops 2% below its nominal value.
- Thermal Regulation is defined as the change in output voltage at a time T after a change in power dissipation is applied, excluding load or line regulation effects. Specifications are for a current pulse equal to  $I_{Lmax}$  at  $V_{IN} = 6V$  for  $T = 10 \text{ ms}$ .
- The maximum allowable power dissipation is a function of ambient temperature, the maximum allowable junction temperature and the thermal resistance from junction-to-air (i.e.,  $T_a$ ,  $T_j$ ,  $\theta_{ja}$ ). Exceeding the maximum allowable power dissipation causes the device to initiate thermal shutdown. Please see [Section 5.0 "Thermal Considerations"](#) for more details.
- The minimum  $V_{IN}$  has to justify the conditions:  $V_{IN} \geq V_R + V_{DROPOUT}$  and  $V_{IN} \geq 2.7V$  for  $I_L = 0.1 \text{ mA}$  to  $I_{OUTMAX}$ .

## TEMPERATURE CHARACTERISTICS

| Parameters                    | Sym           | Min | Typ | Max | Units              | Conditions |
|-------------------------------|---------------|-----|-----|-----|--------------------|------------|
| Thermal Resistance, 5L-SOT-23 | $\theta_{JA}$ | —   | 256 | —   | $^\circ\text{C/W}$ |            |

# TC1070/TC1071/TC1187

## 2.0 TYPICAL CHARACTERISTICS

**Note:** The graphs and tables provided following this note are a statistical summary based on a limited number of samples and are provided for informational purposes only. The performance characteristics listed herein are not tested or guaranteed. In some graphs or tables, the data presented may be outside the specified operating range (e.g., outside specified power supply range) and therefore outside the warranted range.

**Note:** Unless otherwise specified, all parts are measured at temperature = +25°C.

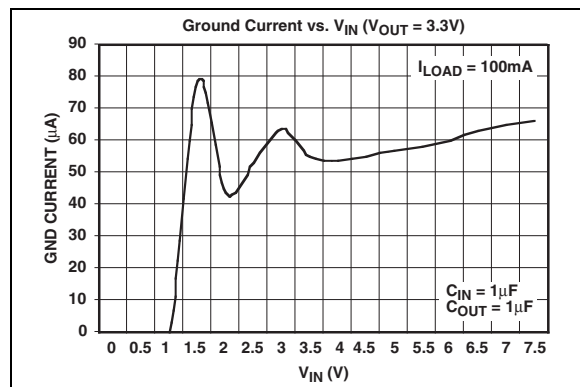
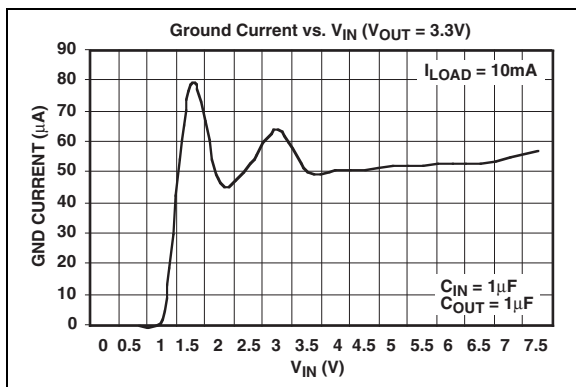
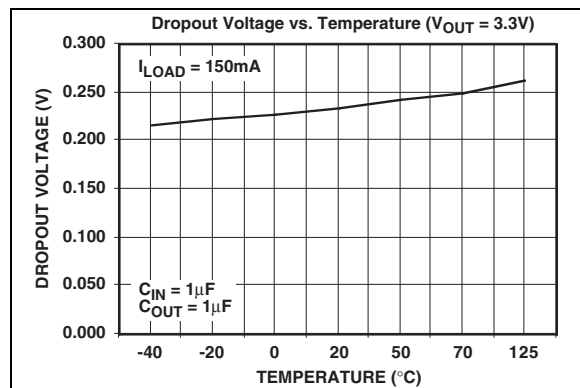
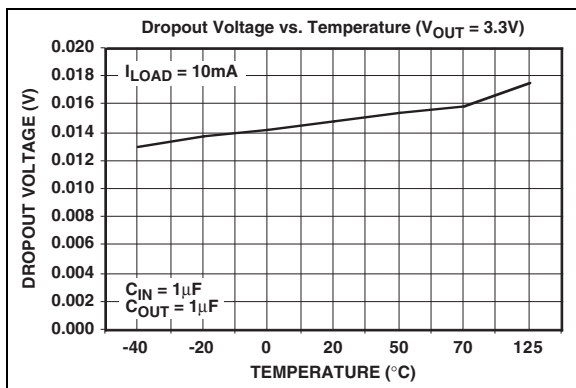
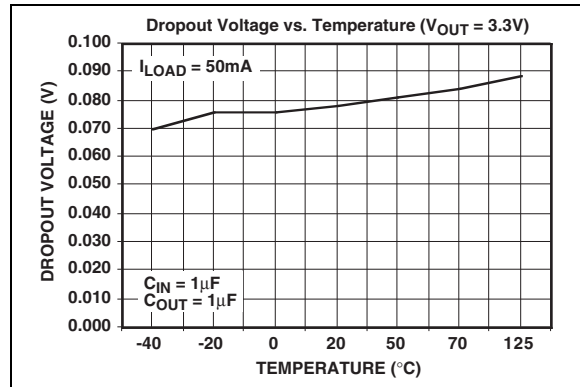
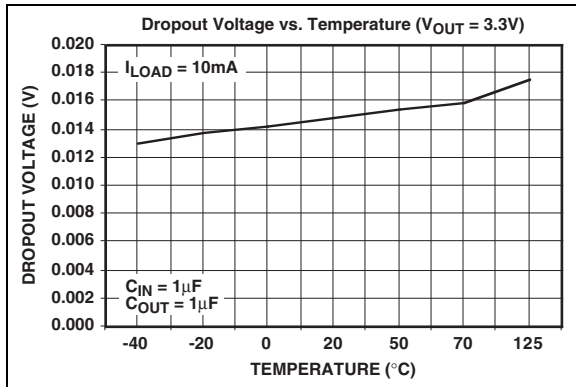

# TC1070/TC1071/TC1187

**Note:** Unless otherwise specified, all parts are measured at temperature = +25°C.

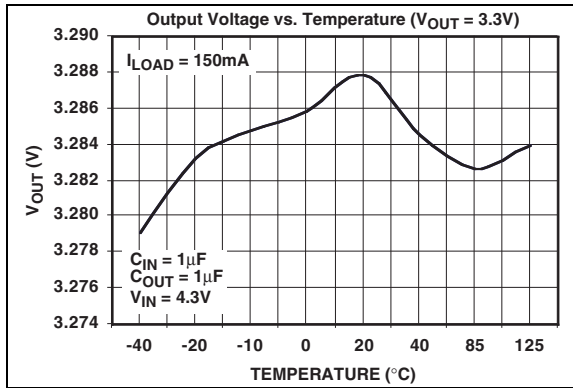
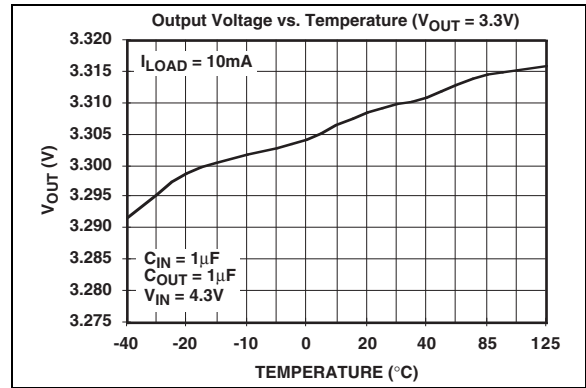
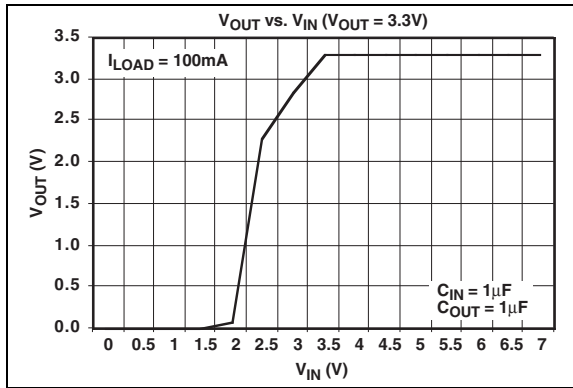
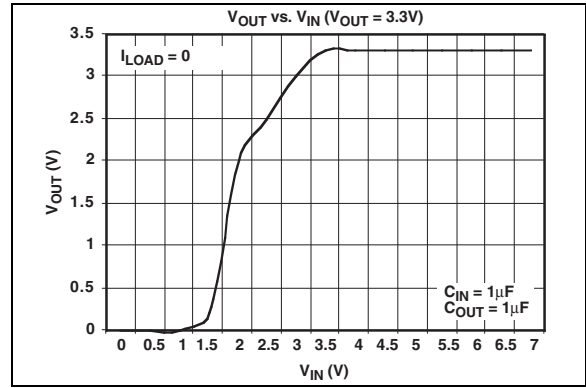
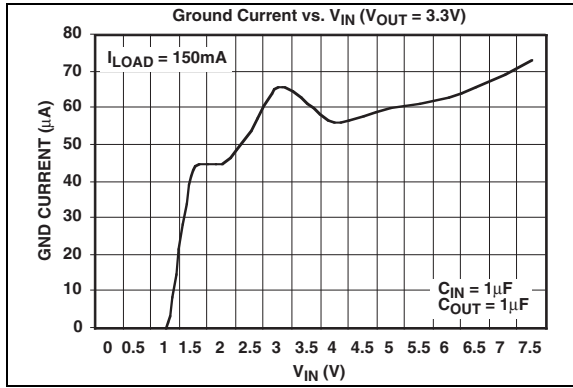

# TC1070/TC1071/TC1187

**Note:** Unless otherwise specified, all parts are measured at temperature = +25°C.

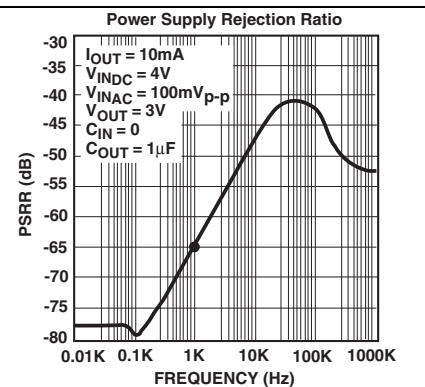
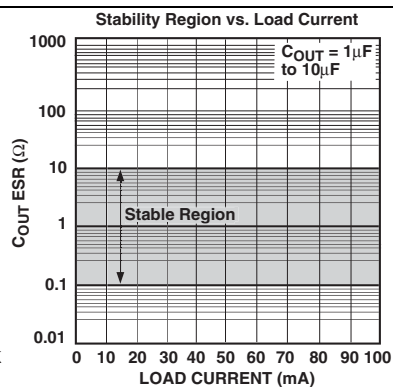
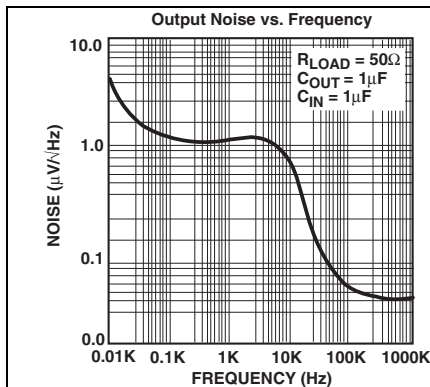
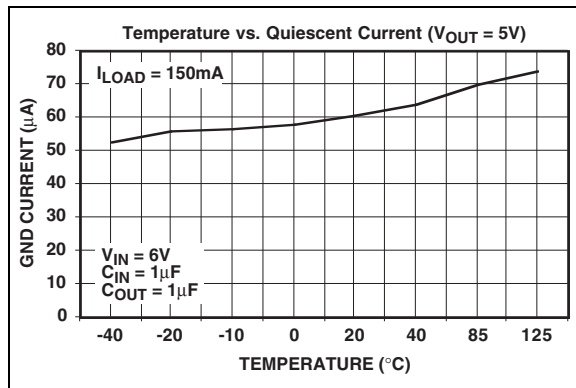
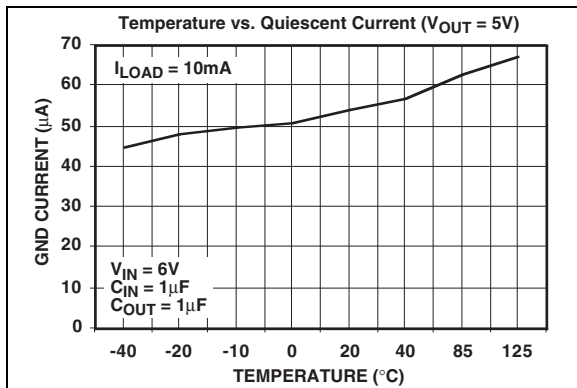
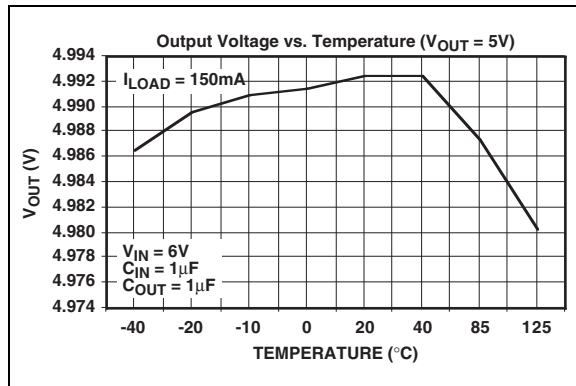
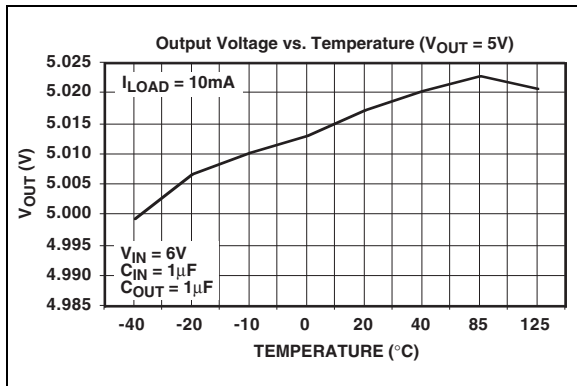

**Note:** Unless otherwise specified, all parts are measured at temperature = +25°C.

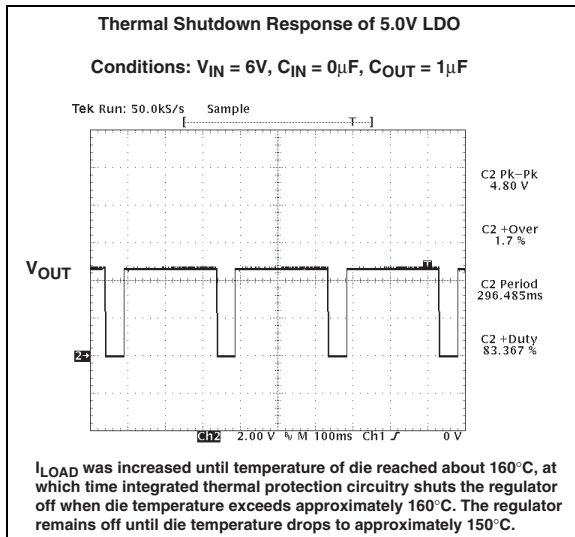
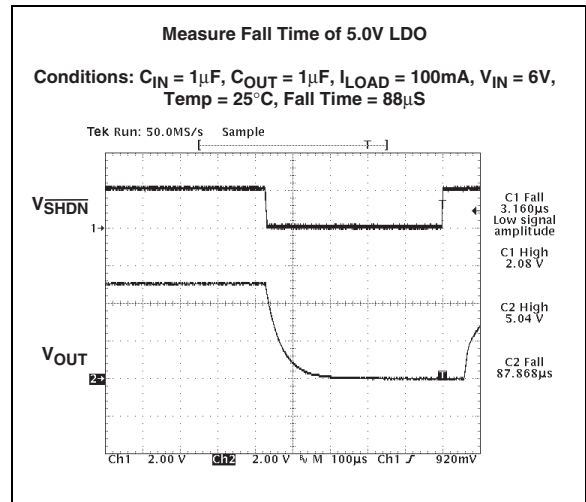
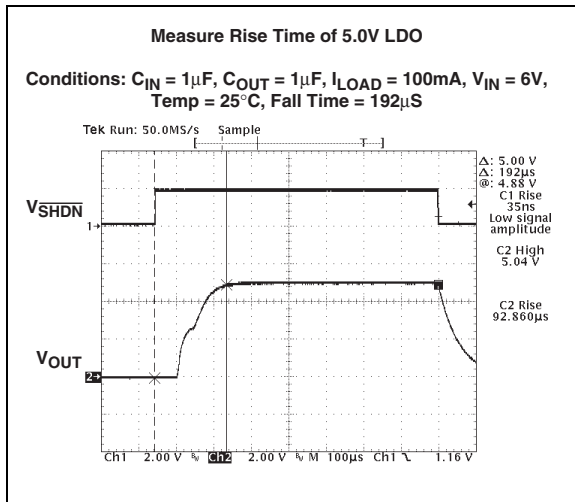
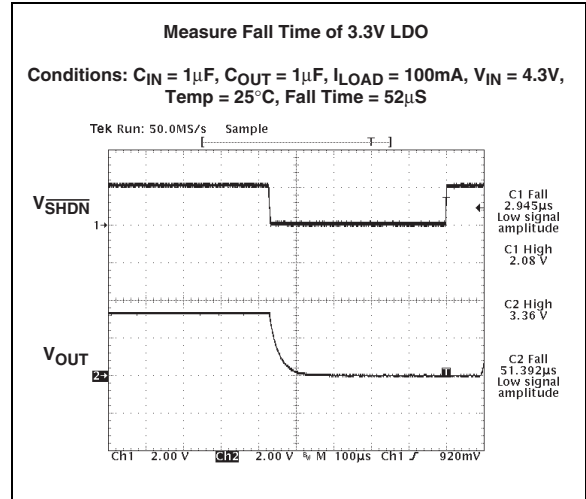
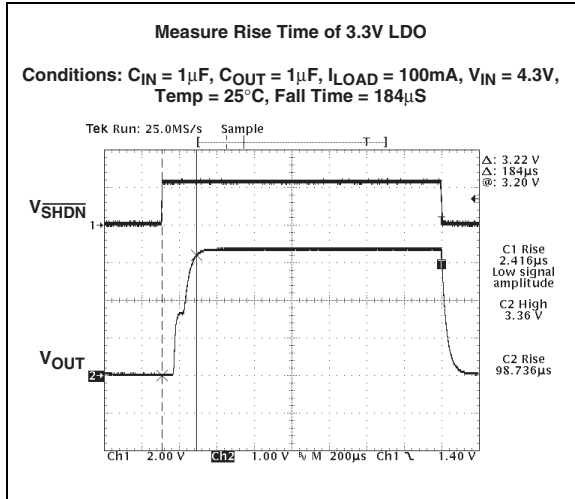

# TC1070/TC1071/TC1187

---

## 3.0 PIN DESCRIPTIONS

The descriptions of the pins are listed in [Table 3-1](#).

**TABLE 3-1: PIN FUNCTION TABLE**

| TC1070/TC1071/TC1187 | Symbol                   | Description                    |
|----------------------|--------------------------|--------------------------------|
| SOT-23               |                          |                                |
| 1                    | $V_{IN}$                 | Unregulated supply input       |
| 2                    | GND                      | Ground terminal                |
| 3                    | $\overline{\text{SHDN}}$ | Shutdown control input         |
| 4                    | ADJ                      | Output voltage adjust terminal |
| 5                    | $V_{OUT}$                | Regulated voltage output       |

### 3.1 Input Voltage Supply ( $V_{IN}$ )

Connect unregulated input supply to the  $V_{IN}$  pin. If there is a large distance between the input supply and the LDO regulator, some input capacitance is necessary for proper operation. A 1  $\mu\text{F}$  capacitor connected from  $V_{IN}$  to ground is recommended for most applications.

### 3.2 Ground (GND)

Connect the unregulated input supply ground return to GND. Also connect the negative side of the 1  $\mu\text{F}$  typical input decoupling capacitor close to GND and the negative side of the output capacitor  $C_1$  to GND.

### 3.3 Shutdown Control Input ( $\overline{\text{SHDN}}$ )

The regulator is fully enabled when a logic high is applied to this input. The regulator enters shutdown when a logic low is applied to this input. During shutdown, output voltage falls to zero and supply current is reduced to 0.5  $\mu\text{A}$  (maximum).

### 3.4 Output Voltage Adjust (ADJ)

Output voltage setting is programmed with a resistor divider from  $V_{OUT}$  to this input.

### 3.5 Regulated Voltage Output ( $V_{OUT}$ )

Connect the output load to  $V_{OUT}$  of the LDO. Also connect the positive side of the LDO output capacitor as close as possible to the  $V_{OUT}$  pin.



## 4.0 DETAILED DESCRIPTION

The TC1070, TC1071 and TC1187 are adjustable output voltage regulators. (If a fixed version is desired, please see the TC1014/TC1015/TC1185 data sheet – DS21335.) Unlike bipolar regulators, the TC1070, TC1071 and TC1187 supply current does not increase with load current. In addition,  $V_{OUT}$  remains stable and within regulation over the entire 0 mA to  $I_{OUTmax}$  operating load current range (an important consideration in RTC and CMOS RAM battery back-up applications).

Figure 4-1 shows a typical application circuit. The regulator is enabled any time the shutdown input (SHDN) is at or above  $V_{IH}$ , and shutdown (disabled) when SHDN is at or below  $V_{IL}$ . SHDN may be controlled by a CMOS logic gate or I/O port of a microcontroller. If the SHDN input is not required, it should be connected directly to the input supply. While in shutdown, supply current decreases to 0.05  $\mu$ A (typical) and  $V_{OUT}$  falls to zero volts.

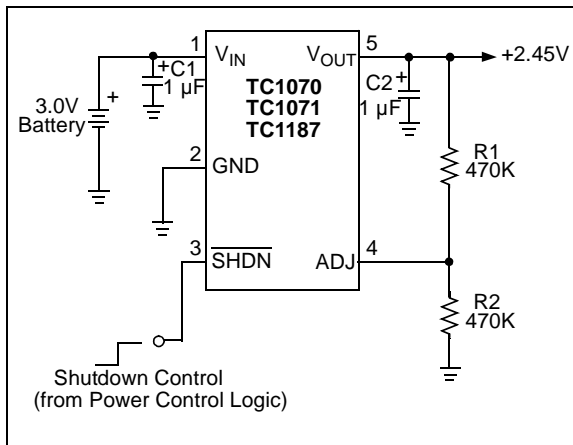

**FIGURE 4-1:** Battery-Operated Supply.

## 4.1 Adjust Input

The output voltage setting is determined by the values of  $R_1$  and  $R_2$  (see Equation 4-1). The ohmic values of these resistors should be between 470K and 3M to minimize bleeder current.

The output voltage setting is calculated using the following equation:

### EQUATION 4-1:

$$V_{OUT} = V_{REF} \times \left[ \frac{R_1}{R_2} \times I \right]$$

The voltage adjustment range of the TC1070, TC1071 and TC1187 is from  $V_{REF}$  to  $(V_{IN} - 0.05V)$ .

## 4.2 Output Capacitor

A 1  $\mu$ F (minimum) capacitor from  $V_{OUT}$  to ground is recommended. The output capacitor should have an effective series resistance greater than 0.1 $\Omega$  and less than 5.0 $\Omega$ , and a resonant frequency above 1 MHz. Aluminum electrolytic or tantalum capacitor types can be used. (Since many aluminum electrolytic capacitors freeze at approximately -30°C, solid tantalums are recommended for applications operating below -25°C.) When operating from sources other than batteries, supply-noise rejection and transient response can be improved by increasing the value of the input and output capacitors and employing passive filtering techniques.

## 4.3 Input Capacitor

A 1  $\mu$ F capacitor should be connected from  $V_{IN}$  to GND if there is more than 10 inches of wire between the regulator and the AC filter capacitor, or if a battery is used as power source.

# TC1070/TC1071/TC1187

## 5.0 THERMAL CONSIDERATIONS

### 5.1 Thermal Shutdown

Integrated thermal protection circuitry shuts the regulator off when die temperature exceeds 160°C. The regulator remains off until the die temperature drops to approximately 150°C.

### 5.2 Power Dissipation

The amount of power the regulator dissipates is primarily a function of input and output voltage, and output current. The following equation is used to calculate worst-case actual power dissipation:

#### EQUATION 5-1:

$$P_D \approx (V_{INmax} - V_{OUTmin})I_{LOADmax}$$

Where:

$P_D$  = Worst-case actual power dissipation

$V_{INmax}$  = Maximum voltage on  $V_{IN}$

$V_{OUTmin}$  = Minimum regulator output voltage

$I_{LOADmax}$  = Maximum output (load) current

The maximum allowable power dissipation (Equation 5-2) is a function of the maximum ambient temperature ( $T_{Amax}$ ), the maximum allowable die temperature ( $T_{Jmax}$ ) and the thermal resistance from junction-to-air ( $\theta_{JA}$ ). The 5-Pin SOT-23 package has a  $\theta_{JA}$  of approximately 220° C/Watt.

#### EQUATION 5-2:

$$P_{Dmax} = \frac{(T_{Jmax} - T_{Amax})}{\theta_{JA}}$$

where all terms are previously defined.

Equation 5-1 can be used in conjunction with Equation 5-2 to ensure regulator thermal operation is within limits. For example:

Given:

$$V_{INmax} = 3.0V \pm 10\%$$

$$V_{OUTmin} = 2.7V - 2\%$$

$$I_{LOADmax} = 40 \text{ mA}$$

$$T_{Jmax} = +125^\circ\text{C}$$

$$T_{Amax} = +55^\circ\text{C}$$

Find:

1. Actual power dissipation
2. Maximum allowable dissipation

Actual power dissipation:

$$\begin{aligned} P_D &\approx (V_{INmax} - V_{OUTmin})I_{LOADmax} \\ &= [(3.0 \times 1.10) - (2.7 \times 0.98)]40 \times 10^{-3} \\ &= 26.2 \text{ mW} \end{aligned}$$

Maximum allowable power dissipation:

$$\begin{aligned} P_{Dmax} &= \frac{(T_{Jmax} - T_{Amax})}{\theta_{JA}} \\ &= \frac{(125 - 55)}{220} \\ &= 318 \text{ mW} \end{aligned}$$

In this example, the TC1070 dissipates a maximum of 26.2 mW which is below the allowable limit of 318 mW. In a similar manner, Equation 5-1 and Equation 5-2 can be used to calculate maximum current and/or input voltage limits.

### 5.3 Layout Considerations

The primary path of heat conduction out of the package is via the package leads. Therefore, layouts having a ground plane, wide traces at the pads, and wide power supply bus lines combine to lower  $\theta_{JA}$  and therefore increase the maximum allowable power dissipation limit.

## 6.0 PACKAGING INFORMATION

### 6.1 Package Marking Information

5-Lead SOT-23-5

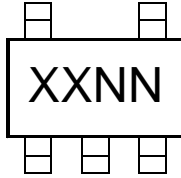

| (V)        | TC1070 Code | TC1071 Code | TC1187 Code |
|------------|-------------|-------------|-------------|
| Adjustable | BANN        | BBNN        | R9NN        |

Example:

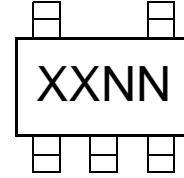

|                |   |  |
|----------------|---|--|
| <b>Legend:</b> | XX...X  | Customer-specific information  |
|                | Y   | Year code (last digit of calendar year)  |
|                | YY  | Year code (last 2 digits of calendar year)   |
|                | WW  | Week code (week of January 1 is week '01')   |
|                | NNN   | Alphanumeric traceability code   |
|                | (e3)  | Pb-free JEDEC designator for Matte Tin (Sn)  |
|                | *   | This package is Pb-free. The Pb-free JEDEC designator (e3) can be found on the outer packaging for this package. |
| <b>Note:</b>   | In the event the full Microchip part number cannot be marked on one line, it will be carried over to the next line, thus limiting the number of available characters for customer-specific information. |  |

### 6.2 Taping Form

**Component Taping Orientation for 5-Pin SOT-23 (EIAJ SC-74A) Devices**

Standard Reel Component Orientation  
for TR Suffix Device  
(Mark Right Side Up)

**Carrier Tape, Number of Components Per Reel and Reel Size:**

| Package      | Carrier Width (W) | Pitch (P) | Part Per Full Reel | Reel Size |
|--------------|-------------------|-----------|--------------------|-----------|
| 5-Pin SOT-23 | 8 mm              | 4 mm      | 3000               | 7 in.     |

# TC1070/TC1071/TC1187

## 5-Lead Plastic Small Outline Transistor (CT) [SOT-23]

**Note:** For the most current package drawings, please see the Microchip Packaging Specification located at <http://www.microchip.com/packaging>

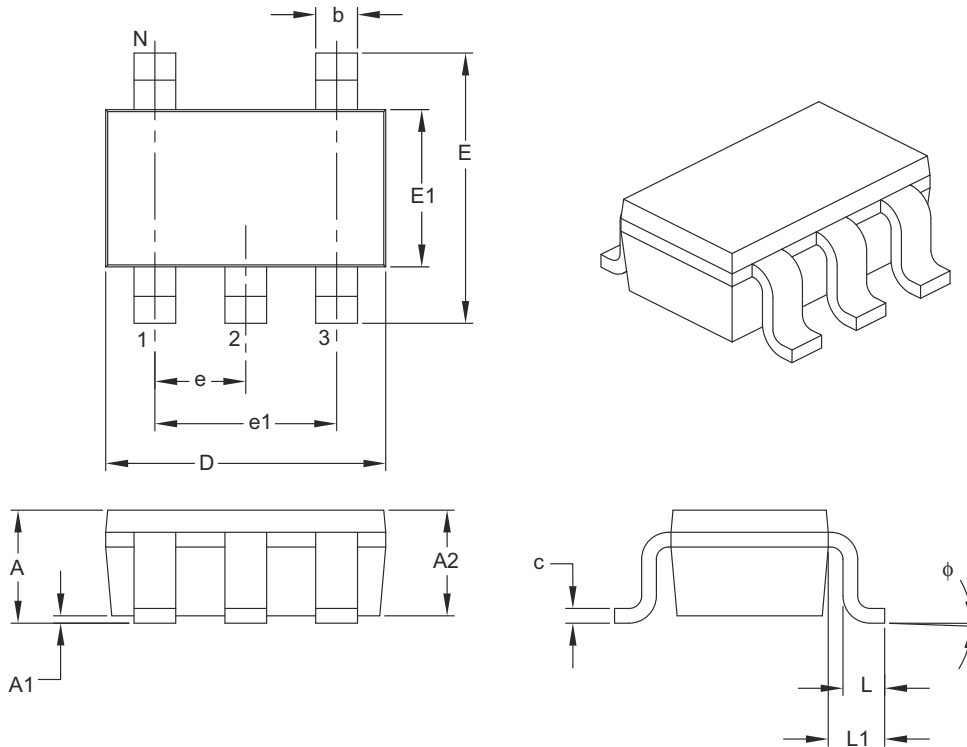

| Dimension Limits         | Units | MILLIMETERS |     |      |
|--------------------------|-------|-------------|-----|------|
|                          |       | MIN         | NOM | MAX  |
| Number of Pins           | N     | 5           |     |      |
| Lead Pitch               | e     | 0.95 BSC    |     |      |
| Outside Lead Pitch       | e1    | 1.90 BSC    |     |      |
| Overall Height           | A     | 0.90        | –   | 1.45 |
| Molded Package Thickness | A2    | 0.89        | –   | 1.30 |
| Standoff                 | A1    | 0.00        | –   | 0.15 |
| Overall Width            | E     | 2.20        | –   | 3.20 |
| Molded Package Width     | E1    | 1.30        | –   | 1.80 |
| Overall Length           | D     | 2.70        | –   | 3.10 |
| Foot Length              | L     | 0.10        | –   | 0.60 |
| Footprint                | L1    | 0.35        | –   | 0.80 |
| Foot Angle               | φ     | 0°          | –   | 30°  |
| Lead Thickness           | c     | 0.08        | –   | 0.26 |
| Lead Width               | b     | 0.20        | –   | 0.51 |

**Notes:**

- Dimensions D and E1 do not include mold flash or protrusions. Mold flash or protrusions shall not exceed 0.127 mm per side.
- Dimensioning and tolerancing per ASME Y14.5M.

BSC: Basic Dimension. Theoretically exact value shown without tolerances.

Microchip Technology Drawing C04-091B

## 5-Lead Plastic Small Outline Transistor (CT) [SOT-23]

**Note:** For the most current package drawings, please see the Microchip Packaging Specification located at <http://www.microchip.com/packaging>

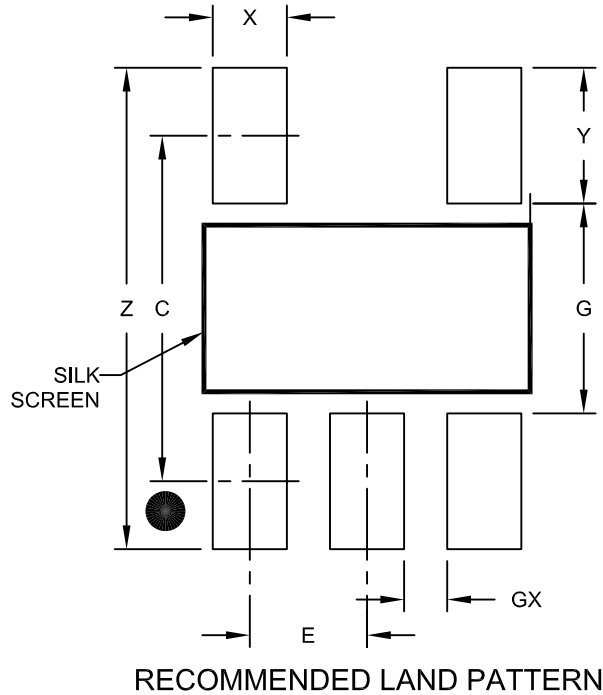

| Dimension Limits        | Units | MILLIMETERS |      |      |
|-------------------------|-------|-------------|------|------|
|                         |       | MIN         | NOM  | MAX  |
| Contact Pitch           | E     | 0.95 BSC    |      |      |
| Contact Pad Spacing     | C     |             | 2.80 |      |
| Contact Pad Width (X5)  | X     |             |      | 0.60 |
| Contact Pad Length (X5) | Y     |             |      | 1.10 |
| Distance Between Pads   | G     | 1.70        |      |      |
| Distance Between Pads   | GX    | 0.35        |      |      |
| Overall Width           | Z     |             |      | 3.90 |

**Notes:**

1. Dimensioning and tolerancing per ASME Y14.5M

BSC: Basic Dimension. Theoretically exact value shown without tolerances.

Microchip Technology Drawing No. C04-2091A

# TC1070/TC1071/TC1187

---

## APPENDIX A: REVISION HISTORY

### Revision E (November 2010)

The following is the list of modifications:

1. Added thermal package resistance in [Temperature Characteristics](#) table.
2. Updated **Section 3.4 “Output Voltage Adjust (ADJ)”**.
3. Updated [Figure 4-1](#).
4. Added new section **Section 4.3 “Input Capacitor”**.

### Revision D (March 2007)

The following is the list of modifications:

1. Ground current changed to 50  $\mu$ A.
2. Package type changed to SOT-23.
3. **Section 3.0 “Pin Descriptions”**: Added pin descriptions.
4. **Section 6.0 “Packaging Information”**: Updated packaging information.

### Revision C (January 2006)

- Undocumented changes.

### Revision B (May 2002)

- Undocumented changes.

### Revision A (March 2002)

- Original Release of this Document.

# TC1070/TC1071/TC1187

## PRODUCT IDENTIFICATION SYSTEM

To order or obtain information, e.g., on pricing or delivery, refer to the factory or the listed sales office.

| <u>PART NO.</u>           | <u>X</u>  | <u>XXXXX</u> |
|---------------------------|---|--------------|
| Device                    | Temperature Range   | Package      |
| <b>Device:</b>            | TC1070: 50 mA, Adjustable CMOS LDO w/Shutdown<br>TC1071: 100 mA, Adjustable CMOS LDO w/Shutdown<br>TC1187: 150 mA, Adjustable CMOS LDO w/Shutdown |              |
| <b>Temperature Range:</b> | V = -40°C to +125°C   |              |
| <b>Package:</b>           | CT713 = Plastic small outline transistor (CT) SOT-23, 5 lead, (tape and reel).  |              |

**Examples:**

- a) TC1070VCT713: 50 mA, Adjustable 5LD SOT-23 package
- b) TC1071VCT713: 100 mA, Adjustable, 5LD SOT-23 package
- c) TC1187VCT713: 150 mA, Adjustable 5LD SOT-23 package

---

---

**Note the following details of the code protection feature on Microchip devices:**

- Microchip products meet the specification contained in their particular Microchip Data Sheet.
- Microchip believes that its family of products is one of the most secure families of its kind on the market today, when used in the intended manner and under normal conditions.
- There are dishonest and possibly illegal methods used to breach the code protection feature. All of these methods, to our knowledge, require using the Microchip products in a manner outside the operating specifications contained in Microchip's Data Sheets. Most likely, the person doing so is engaged in theft of intellectual property.
- Microchip is willing to work with the customer who is concerned about the integrity of their code.
- Neither Microchip nor any other semiconductor manufacturer can guarantee the security of their code. Code protection does not mean that we are guaranteeing the product as "unbreakable."

Code protection is constantly evolving. We at Microchip are committed to continuously improving the code protection features of our products. Attempts to break Microchip's code protection feature may be a violation of the Digital Millennium Copyright Act. If such acts allow unauthorized access to your software or other copyrighted work, you may have a right to sue for relief under that Act.

Information contained in this publication regarding device applications and the like is provided only for your convenience and may be superseded by updates. It is your responsibility to ensure that your application meets with your specifications. MICROCHIP MAKES NO REPRESENTATIONS OR WARRANTIES OF ANY KIND WHETHER EXPRESS OR IMPLIED, WRITTEN OR ORAL, STATUTORY OR OTHERWISE, RELATED TO THE INFORMATION, INCLUDING BUT NOT LIMITED TO ITS CONDITION, QUALITY, PERFORMANCE, MERCHANTABILITY OR FITNESS FOR PURPOSE. Microchip disclaims all liability arising from this information and its use. Use of Microchip devices in life support and/or safety applications is entirely at the buyer's risk, and the buyer agrees to defend, indemnify and hold harmless Microchip from any and all damages, claims, suits, or expenses resulting from such use. No licenses are conveyed, implicitly or otherwise, under any Microchip intellectual property rights.

**Trademarks**

The Microchip name and logo, the Microchip logo, dsPIC, KEELOQ, KEELOQ logo, MPLAB, PIC, PICmicro, PICSTART, PIC<sup>32</sup> logo, rfPIC and UNI/O are registered trademarks of Microchip Technology Incorporated in the U.S.A. and other countries.

FilterLab, Hampshire, HI-TECH C, Linear Active Thermistor, MXDEV, MXLAB, SEEVAL and The Embedded Control Solutions Company are registered trademarks of Microchip Technology Incorporated in the U.S.A.

Analog-for-the-Digital Age, Application Maestro, CodeGuard, dsPICDEM, dsPICDEM.net, dsPICworks, dsSPEAK, ECAN, ECONOMONITOR, FanSense, HI-TIDE, In-Circuit Serial Programming, ICSP, Mindi, MiWi, MPASM, MPLAB Certified logo, MPLIB, MPLINK, mTouch, Omniscient Code Generation, PICC, PICC-18, PICDEM, PICDEM.net, PICKit, PICTail, REAL ICE, rLAB, Select Mode, Total Endurance, TSHARC, UniWinDriver, WiperLock and ZENA are trademarks of Microchip Technology Incorporated in the U.S.A. and other countries.

SQTP is a service mark of Microchip Technology Incorporated in the U.S.A.

All other trademarks mentioned herein are property of their respective companies.

© 2010, Microchip Technology Incorporated, Printed in the U.S.A., All Rights Reserved.

 Printed on recycled paper.

ISBN: 978-1-60932-685-2

*Microchip received ISO/TS-16949:2002 certification for its worldwide headquarters, design and wafer fabrication facilities in Chandler and Tempe, Arizona; Gresham, Oregon and design centers in California and India. The Company's quality system processes and procedures are for its PIC<sup>®</sup> MCUs and dsPIC<sup>®</sup> DSCs, KEELOQ<sup>®</sup> code hopping devices, Serial EEPROMs, microperipherals, nonvolatile memory and analog products. In addition, Microchip's quality system for the design and manufacture of development systems is ISO 9001:2000 certified.*

**QUALITY MANAGEMENT SYSTEM  
CERTIFIED BY DNV  
== ISO/TS 16949:2002 ==**





# MICROCHIP

## Worldwide Sales and Service

### AMERICAS

**Corporate Office**  
2355 West Chandler Blvd.  
Chandler, AZ 85224-6199  
Tel: 480-792-7200  
Fax: 480-792-7277  
Technical Support:  
<http://support.microchip.com>  
Web Address:  
[www.microchip.com](http://www.microchip.com)

**Atlanta**  
Duluth, GA  
Tel: 678-957-9614  
Fax: 678-957-1455

**Boston**  
Westborough, MA  
Tel: 774-760-0087  
Fax: 774-760-0088

**Chicago**  
Itasca, IL  
Tel: 630-285-0071  
Fax: 630-285-0075

**Cleveland**  
Independence, OH  
Tel: 216-447-0464  
Fax: 216-447-0643

**Dallas**  
Addison, TX  
Tel: 972-818-7423  
Fax: 972-818-2924

**Detroit**  
Farmington Hills, MI  
Tel: 248-538-2250  
Fax: 248-538-2260

**Kokomo**  
Kokomo, IN  
Tel: 765-864-8360  
Fax: 765-864-8387

**Los Angeles**  
Mission Viejo, CA  
Tel: 949-462-9523  
Fax: 949-462-9608

**Santa Clara**  
Santa Clara, CA  
Tel: 408-961-6444  
Fax: 408-961-6445

**Toronto**  
Mississauga, Ontario,  
Canada  
Tel: 905-673-0699  
Fax: 905-673-6509

### ASIA/PACIFIC

**Asia Pacific Office**  
Suites 3707-14, 37th Floor  
Tower 6, The Gateway  
Harbour City, Kowloon  
Hong Kong  
Tel: 852-2401-1200  
Fax: 852-2401-3431

**Australia - Sydney**  
Tel: 61-2-9868-6733  
Fax: 61-2-9868-6755

**China - Beijing**  
Tel: 86-10-8528-2100  
Fax: 86-10-8528-2104

**China - Chengdu**  
Tel: 86-28-8665-5511  
Fax: 86-28-8665-7889

**China - Chongqing**  
Tel: 86-23-8980-9588  
Fax: 86-23-8980-9500

**China - Hong Kong SAR**  
Tel: 852-2401-1200  
Fax: 852-2401-3431

**China - Nanjing**  
Tel: 86-25-8473-2460  
Fax: 86-25-8473-2470

**China - Qingdao**  
Tel: 86-532-8502-7355  
Fax: 86-532-8502-7205

**China - Shanghai**  
Tel: 86-21-5407-5533  
Fax: 86-21-5407-5066

**China - Shenyang**  
Tel: 86-24-2334-2829  
Fax: 86-24-2334-2393

**China - Shenzhen**  
Tel: 86-755-8203-2660  
Fax: 86-755-8203-1760

**China - Wuhan**  
Tel: 86-27-5980-5300  
Fax: 86-27-5980-5118

**China - Xian**  
Tel: 86-29-8833-7252  
Fax: 86-29-8833-7256

**China - Xiamen**  
Tel: 86-592-2388138  
Fax: 86-592-2388130

**China - Zhuhai**  
Tel: 86-756-3210040  
Fax: 86-756-3210049

### ASIA/PACIFIC

**India - Bangalore**  
Tel: 91-80-3090-4444  
Fax: 91-80-3090-4123

**India - New Delhi**  
Tel: 91-11-4160-8631  
Fax: 91-11-4160-8632

**India - Pune**  
Tel: 91-20-2566-1512  
Fax: 91-20-2566-1513

**Japan - Yokohama**  
Tel: 81-45-471- 6166  
Fax: 81-45-471-6122

**Korea - Daegu**  
Tel: 82-53-744-4301  
Fax: 82-53-744-4302

**Korea - Seoul**  
Tel: 82-2-554-7200  
Fax: 82-2-558-5932 or  
82-2-558-5934

**Malaysia - Kuala Lumpur**  
Tel: 60-3-6201-9857  
Fax: 60-3-6201-9859

**Malaysia - Penang**  
Tel: 60-4-227-8870  
Fax: 60-4-227-4068

**Philippines - Manila**  
Tel: 63-2-634-9065  
Fax: 63-2-634-9069

**Singapore**  
Tel: 65-6334-8870  
Fax: 65-6334-8850

**Taiwan - Hsin Chu**  
Tel: 886-3-6578-300  
Fax: 886-3-6578-370

**Taiwan - Kaohsiung**  
Tel: 886-7-213-7830  
Fax: 886-7-330-9305

**Taiwan - Taipei**  
Tel: 886-2-2500-6610  
Fax: 886-2-2508-0102

**Thailand - Bangkok**  
Tel: 66-2-694-1351  
Fax: 66-2-694-1350

### EUROPE

**Austria - Wels**  
Tel: 43-7242-2244-39  
Fax: 43-7242-2244-393

**Denmark - Copenhagen**  
Tel: 45-4450-2828  
Fax: 45-4485-2829

**France - Paris**  
Tel: 33-1-69-53-63-20  
Fax: 33-1-69-30-90-79

**Germany - Munich**  
Tel: 49-89-627-144-0  
Fax: 49-89-627-144-44

**Italy - Milan**  
Tel: 39-0331-742611  
Fax: 39-0331-466781

**Netherlands - Drunen**  
Tel: 31-416-690399  
Fax: 31-416-690340

**Spain - Madrid**  
Tel: 34-91-708-08-90  
Fax: 34-91-708-08-91

**UK - Wokingham**  
Tel: 44-118-921-5869  
Fax: 44-118-921-5820

08/04/10



Компания «ЭлектроПласт» предлагает заключение долгосрочных отношений при поставках импортных электронных компонентов на взаимовыгодных условиях!

Наши преимущества:

- Оперативные поставки широкого спектра электронных компонентов отечественного и импортного производства напрямую от производителей и с крупнейших мировых складов;
- Поставка более 17-ти миллионов наименований электронных компонентов;
- Поставка сложных, дефицитных, либо снятых с производства позиций;
- Оперативные сроки поставки под заказ (от 5 рабочих дней);
- Экспресс доставка в любую точку России;
- Техническая поддержка проекта, помощь в подборе аналогов, поставка прототипов;
- Система менеджмента качества сертифицирована по Международному стандарту ISO 9001;
- Лицензия ФСБ на осуществление работ с использованием сведений, составляющих государственную тайну;
- Поставка специализированных компонентов (Xilinx, Altera, Analog Devices, Intersil, Interpoint, Microsemi, Aeroflex, Peregrine, Syfer, Eurofarad, Texas Instrument, Miteq, Cobham, E2V, MA-COM, Hittite, Mini-Circuits, General Dynamics и др.);

Помимо этого, одним из направлений компании «ЭлектроПласт» является направление «Источники питания». Мы предлагаем Вам помощь Конструкторского отдела:

- Подбор оптимального решения, техническое обоснование при выборе компонента;
- Подбор аналогов;
- Консультации по применению компонента;
- Поставка образцов и прототипов;
- Техническая поддержка проекта;
- Защита от снятия компонента с производства.



#### Как с нами связаться

**Телефон:** 8 (812) 309 58 32 (многоканальный)

**Факс:** 8 (812) 320-02-42

**Электронная почта:** [org@eplast1.ru](mailto:org@eplast1.ru)

**Адрес:** 198099, г. Санкт-Петербург, ул. Калинина, дом 2, корпус 4, литера А.