



W23



W31

# W23/W31 series

## Toggle or Push/Pull Actuator Thermal P&B Circuit Breaker



### Features

- 0.5 amp to 50 amp ratings may be used as on/off switch.
- Cannot be reset against overload.
- W23 has visible trip indicator band.
- Screw termination.
- Trip-free operation.

### Agency Approvals

W23 and W31 are UL 1077 Recognized as Supplementary Protectors. File E69543, and CSA Accepted as Supplementary Protectors (Appliance Component Protectors), File LR15734.

Users should thoroughly review the technical data before selecting a product part number. It is recommended that users also seek out the pertinent approvals files of the agencies/laboratories and review them to ensure the product meets the requirements for a given application.

### Electrical Data @ +25°C

**Calibration:** Will continuously carry 100% of rating, may trip between 101% and 134% of rating at 25°C. Must trip at 135% in one hour.

**Maximum Operating Voltages:** 50VDC or 240VAC (to 400 Hz).

#### Interrupting Capacity:

##### With 4X Max. Series Fuse Protection

- 0.5-50 amp models — 1000 amps at 240VAC.
- 30-50 amp models — 1000 amps at 50VDC.

##### Without 4X Max. Series Fuse Protection

- 0.5-25 amp models — 2000 amps at 50VDC.
- 10-20 amp models — 2000 amps at 120VAC.

**Resettable Overload Capacity:** Ten times rated current.

**Dielectric Strength:** Over 1,500 volts RMS.

### Time Vs. Current Trip Curve @ +25°C

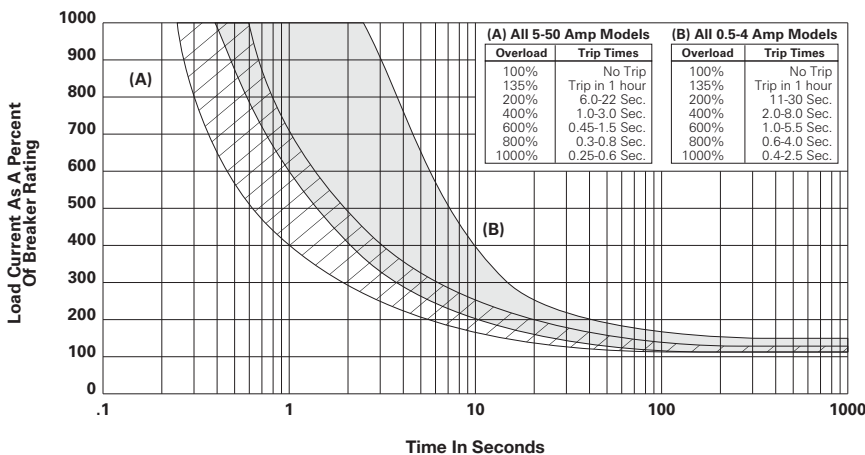

### Maximum Resistance vs. Current Rating @ +25°C

Current Rating in Amps	Maximum Resistance in Ohms ± 30%
1	.61
5	.03
10	.01
15	.006
20	.004
30	.003
40	.002
50	.002

### Mechanical/Environmental Data

**Endurance Cycling:** More than 6,000 cycles at 100% of rating, or 10,000 mechanical cycles.

**Humidity:** Will meet requirements of MIL-STD-202, Method 106.

**Salt Spray:** Will meet requirements of MIL-STD-202, Method 101, Test Condition B.

**Termination:** Two #8-32 screw terminals.

**Mounting:** W23 — Threaded bushing, 3/8" (9.53mm) diameter.

W31 — Threaded bushing, 15/32" (11.91mm) diameter, with or without anti-rotation flats.

**Weight:** Less than 2 oz. (57g).

### Ambient Compensation Chart

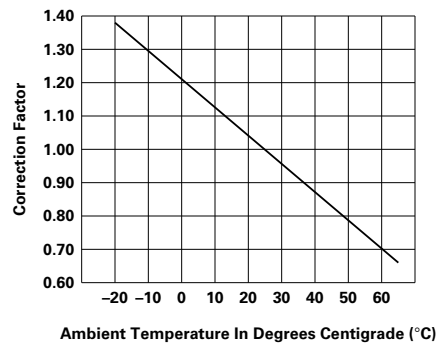

**To use this chart:** Read up from the ambient temperature to the curve, and across to find a correction factor. Multiply the breaker rating by the correction factor to determine the compensated rating. Calculate the overloads in terms of the compensated rating to use the published trip curve.

**Ordering Information**

<b>Typical Part No. ▶</b>	<b>W</b>	<b>23</b>	<b>-X</b>	<b>1</b>	<b>A</b>	<b>1</b>	<b>G</b>	<b>-5</b>
<b>1. Designator:</b> W = Circuit breaker								
<b>2. Series Number:</b> 23 = Single pole, push/pull								
<b>3. Circuit Function:</b> X = Series trip								
<b>4. Button:</b> 1 = Black with white amp rate marking and white trip band.								
<b>5. Mounting Bushing:</b> A = 3/8"-24 threaded bushing .375" (9.53mm) long, silver color								
<b>6. Terminals (See drawings for relative terminal positions):</b> 1 = Screw terminals situated 90° to each other with #8-32 screws and washers installed. 3 = Screw terminals situated parallel to each other pointing upward with #8-32 screws and washers installed.								
<b>7. Mounting Hardware:</b> A = Knurled nut/hex nut installed G = Two hex nuts/lockwasher installed Z = No mounting hardware supplied								
<b>8. Amp Rating:</b>								
0.5	3	7.5	20	35				
1	4	10	25	40				
2	5	15	30	50				

**Stock Items – Authorized distributors are more likely to stock the following items.**

W23-X1A1G-1	W23-X1A1G-7.50	W23-X1A1G-25	W23-X1A1G-50
W23-X1A1G-2	W23-X1A1G-10	W23-X1A1G-30	
W23-X1A1G-3	W23-X1A1G-15	W23-X1A1G-35	
W23-X1A1G-5	W23-X1A1G-20	W23-X1A1G-40	

**Ordering Information**

<b>Typical Part No. ▶</b>	<b>W</b>	<b>31</b>	<b>-X</b>	<b>2</b>	<b>M</b>	<b>1</b>	<b>G</b>	<b>-5</b>
<b>1. Designator:</b> W = Circuit breaker								
<b>2. Series Number:</b> 31 = Single pole, toggle actuator								
<b>3. Circuit Function:</b> X = Series trip								
<b>4. Mounting Bushing:</b> 1 = 15/32"-32 threaded bushing .320" (8.13mm) long, round, silver color 2 = 15/32"-32 threaded bushing .320" (8.13mm) long, double "D," silver color								
<b>5. Toggle:</b> M = Silver color metal toggle, round, with amp rate marking on end								
<b>6. Terminals (See drawing for relative terminal positions):</b> 1 = Screw terminals situated 90° to each other with #8-32 screws and washers installed. 5 = Screw terminals situated parallel to each other pointing downward with #8-32 screws and washers installed.								
<b>7. Mounting Hardware:</b> A = Knurled nut/hex nut installed G = Two hex nuts/lockwasher installed Z = No mounting hardware supplied								
<b>8. Amp Rating:</b>								
0.5	3	7.5	20	35				
1	4	10	25	40				
2	5	15	30	50				

**Stock Items – Authorized distributors are more likely to stock the following items.**

W31-X2M1G-1	W31-X2M1G-10	W31-X2M1G-35
W31-X2M1G-2	W31-X2M1G-15	W31-X2M1G-40
W31-X2M1G-3	W31-X2M1G-20	W31-X2M1G-50
W31-X2M1G-5	W31-X2M1G-25	
W31-X2M1G-7.50	W31-X2M1G-30	

**W23 Outline Dimensions**

**Terminal Style 1**

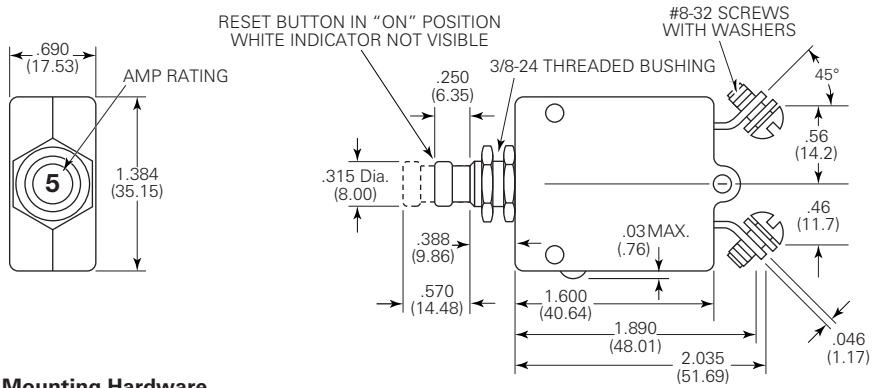

**Terminal Style 3**

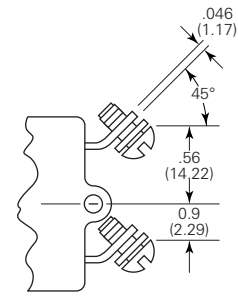

All dimensions are given as inches (mm)

**Mounting Hardware**

**Hex Nut**

(55-001D - Silver Color)

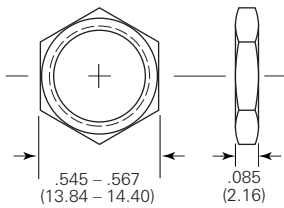

**Lockwasher**

(88-006B - Silver Color)

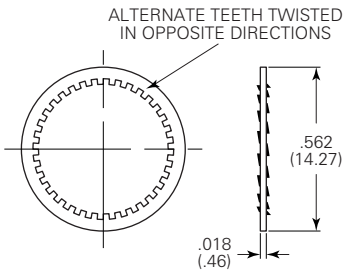

**Knurled Nut**

(55-008A - Silver Color)

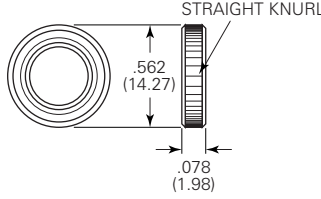

**Suggested Mounting Holes**

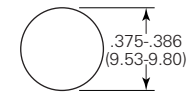

**W31 Outline Dimensions**

**Terminal Style 1**

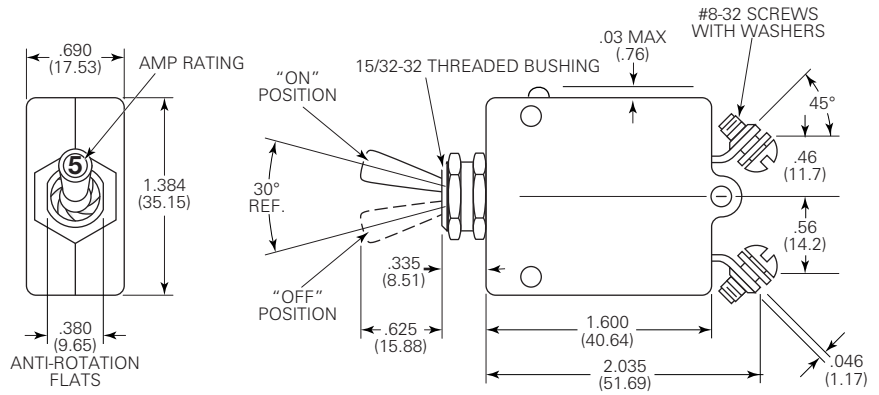

**Terminal Style 5**

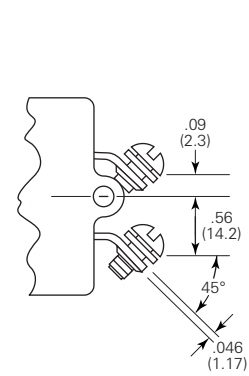

**Mounting Hardware**

**Hex Nut**

(55-001B - Silver Color)

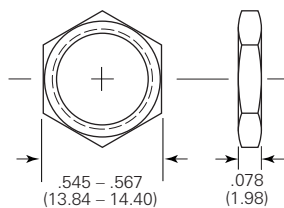

**Lockwasher**

(88-002B - Silver Color)

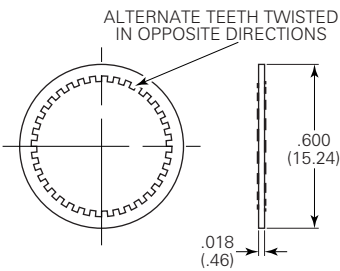

**Knurled Nut**

(55-010B - Silver Color)

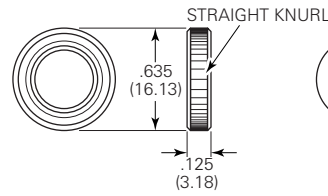

**Suggested Mounting Holes**

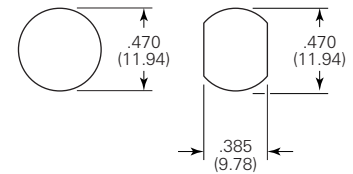



Компания «ЭлектроПласт» предлагает заключение долгосрочных отношений при поставках импортных электронных компонентов на взаимовыгодных условиях!

Наши преимущества:

- Оперативные поставки широкого спектра электронных компонентов отечественного и импортного производства напрямую от производителей и с крупнейших мировых складов;
- Поставка более 17-ти миллионов наименований электронных компонентов;
- Поставка сложных, дефицитных, либо снятых с производства позиций;
- Оперативные сроки поставки под заказ (от 5 рабочих дней);
- Экспресс доставка в любую точку России;
- Техническая поддержка проекта, помощь в подборе аналогов, поставка прототипов;
- Система менеджмента качества сертифицирована по Международному стандарту ISO 9001;
- Лицензия ФСБ на осуществление работ с использованием сведений, составляющих государственную тайну;
- Поставка специализированных компонентов (Xilinx, Altera, Analog Devices, Intersil, Interpoint, Microsemi, Aeroflex, Peregrine, Syfer, Eurofarad, Texas Instrument, Miteq, Cobham, E2V, MA-COM, Hittite, Mini-Circuits, General Dynamics и др.);

Помимо этого, одним из направлений компании «ЭлектроПласт» является направление «Источники питания». Мы предлагаем Вам помощь Конструкторского отдела:

- Подбор оптимального решения, техническое обоснование при выборе компонента;
- Подбор аналогов;
- Консультации по применению компонента;
- Поставка образцов и прототипов;
- Техническая поддержка проекта;
- Защита от снятия компонента с производства.



#### Как с нами связаться

**Телефон:** 8 (812) 309 58 32 (многоканальный)

**Факс:** 8 (812) 320-02-42

**Электронная почта:** [org@eplast1.ru](mailto:org@eplast1.ru)

**Адрес:** 198099, г. Санкт-Петербург, ул. Калинина, дом 2, корпус 4, литера А.