



MCP1630
Input Boost Converter
Demo Board
User's Guide

Note the following details of the code protection feature on Microchip devices:

- Microchip products meet the specification contained in their particular Microchip Data Sheet.
- Microchip believes that its family of products is one of the most secure families of its kind on the market today, when used in the intended manner and under normal conditions.
- There are dishonest and possibly illegal methods used to breach the code protection feature. All of these methods, to our knowledge, require using the Microchip products in a manner outside the operating specifications contained in Microchip's Data Sheets. Most likely, the person doing so is engaged in theft of intellectual property.
- Microchip is willing to work with the customer who is concerned about the integrity of their code.
- Neither Microchip nor any other semiconductor manufacturer can guarantee the security of their code. Code protection does not mean that we are guaranteeing the product as "unbreakable."

Code protection is constantly evolving. We at Microchip are committed to continuously improving the code protection features of our products. Attempts to break Microchip's code protection feature may be a violation of the Digital Millennium Copyright Act. If such acts allow unauthorized access to your software or other copyrighted work, you may have a right to sue for relief under that Act.

Information contained in this publication regarding device applications and the like is provided only for your convenience and may be superseded by updates. It is your responsibility to ensure that your application meets with your specifications. MICROCHIP MAKES NO REPRESENTATIONS OR WARRANTIES OF ANY KIND WHETHER EXPRESS OR IMPLIED, WRITTEN OR ORAL, STATUTORY OR OTHERWISE, RELATED TO THE INFORMATION, INCLUDING BUT NOT LIMITED TO ITS CONDITION, QUALITY, PERFORMANCE, MERCHANTABILITY OR FITNESS FOR PURPOSE. Microchip disclaims all liability arising from this information and its use. Use of Microchip devices in life support and/or safety applications is entirely at the buyer's risk, and the buyer agrees to defend, indemnify and hold harmless Microchip from any and all damages, claims, suits, or expenses resulting from such use. No licenses are conveyed, implicitly or otherwise, under any Microchip intellectual property rights.

Trademarks

The Microchip name and logo, the Microchip logo, Accuron, dsPIC, KEELOQ, KEELOQ logo, microID, MPLAB, PIC, PICmicro, PICSTART, PRO MATE, rfPIC and SmartShunt are registered trademarks of Microchip Technology Incorporated in the U.S.A. and other countries.

AmpLab, FilterLab, Linear Active Thermistor, Migratable Memory, MXDEV, MXLAB, SEEVAL, SmartSensor and The Embedded Control Solutions Company are registered trademarks of Microchip Technology Incorporated in the U.S.A.

Analog-for-the-Digital Age, Application Maestro, CodeGuard, dsPICDEM, dsPICDEM.net, dsPICworks, ECAN, ECONOMONITOR, FanSense, FlexROM, fuzzyLAB, In-Circuit Serial Programming, ICSP, ICEPIC, Mindi, MiWi, MPASM, MPLAB Certified logo, MPLIB, MPLINK, PICkit, PICDEM, PICDEM.net, PICLAB, PICtail, PowerCal, PowerInfo, PowerMate, PowerTool, REAL ICE, rFLAB, Select Mode, Smart Serial, SmartTel, Total Endurance, UNI/O, WiperLock and ZENA are trademarks of Microchip Technology Incorporated in the U.S.A. and other countries.

SQTP is a service mark of Microchip Technology Incorporated in the U.S.A.

All other trademarks mentioned herein are property of their respective companies.

© 2007, Microchip Technology Incorporated, Printed in the U.S.A., All Rights Reserved.

 Printed on recycled paper.

QUALITY MANAGEMENT SYSTEM
CERTIFIED BY DNV
== ISO/TS 16949:2002 ==

Microchip received ISO/TS-16949:2002 certification for its worldwide headquarters, design and wafer fabrication facilities in Chandler and Tempe, Arizona; Gresham, Oregon and design centers in California and India. The Company's quality system processes and procedures are for its PIC® MCUs and dsPIC® DSCs, KEELOQ® code hopping devices, Serial EEPROMs, microperipherals, nonvolatile memory and analog products. In addition, Microchip's quality system for the design and manufacture of development systems is ISO 9001:2000 certified.



MCP1630 AUTOMOTIVE INPUT BOOST CONVERTER DEMO BOARD USER'S GUIDE

Table of Contents

Preface	1
Introduction.....	1
Document Layout	1
Conventions Used in this Guide	2
Recommended Reading.....	2
The Microchip Web Site	3
Customer Support	3
Document Revision History	3
Chapter 1. Product Overview	
1.1 Introduction.....	5
1.2 What is the MCP1630 Automotive Input Boost Converter Demo Board?	6
1.3 What the MCP1630 Automotive Input Boost Converter Demo Board Kit Includes	6
Chapter 2. Installation and Operation	
2.1 Introduction.....	7
2.2 Features	7
2.3 Getting Started	8
Appendix A. Schematic and Layouts	
A.1 Introduction	11
A.2 Board – Schematic.....	12
A.3 Board – Top Silk Layer	13
A.4 Board – Top Metal Layer	14
A.5 Board – Bottom Metal Layer	15
Appendix B. Bill Of Materials (BOM)	
Appendix C. Demo Board Firmware	
C.1 Device Firmware.....	19
Worldwide Sales and Service	20

MCP1630 Automotive Input Boost Converter Demo Board User's Guide

NOTES:



MCP1630 AUTOMOTIVE INPUT BOOST CONVERTER DEMO BOARD USER'S GUIDE

Preface

NOTICE TO CUSTOMERS

All documentation becomes dated, and this manual is no exception. Microchip tools and documentation are constantly evolving to meet customer needs, so some actual dialogs and/or tool descriptions may differ from those in this document. Please refer to our web site (www.microchip.com) to obtain the latest documentation available.

Documents are identified with a “DS” number. This number is located on the bottom of each page, in front of the page number. The numbering convention for the DS number is “DSXXXXA”, where “XXXX” is the document number and “A” is the revision level of the document.

For the most up-to-date information on development tools, see the MPLAB® IDE on-line help. Select the Help menu, and then Topics to open a list of available on-line help files.

INTRODUCTION

This chapter contains general information that will be useful to know before using the MCP1630 Automotive Input Boost Converter Demo Board. Items discussed in this chapter include:

- Document Layout
- Conventions Used in this Guide
- Recommended Reading
- The Microchip Web Site
- Customer Support
- Document Revision History

DOCUMENT LAYOUT

This document describes how to use the MCP1630 Automotive Input Boost Converter Demo Board. The manual layout is as follows:

- **Chapter 1. “Product Overview”** – Important information about the MCP1630 Automotive Input Boost Converter Demo Board.
- **Chapter 2. “Installation and Operation”** – Includes instructions on how to get started with this user’s guide and a description of the user’s guide.
- **Appendix A. “Schematic and Layouts”** – Shows the schematic and layout diagrams for the MCP1630 Automotive Input Boost Converter Demo Board.
- **Appendix B. “Bill Of Materials (BOM)”** – Lists the parts used to build the MCP1630 Automotive Input Boost Converter Demo Board.
- **Appendix C. “Demo Board Firmware”** – Provides information about the application firmware and where the source code can be found.

CONVENTIONS USED IN THIS GUIDE

This manual uses the following documentation conventions:

DOCUMENTATION CONVENTIONS

Description	Represents	Examples
Arial font:		
Italic characters	Referenced books	<i>MPLAB[®] IDE User's Guide</i>
	Emphasized text	...is the <i>only</i> compiler...
Initial caps	A window	the Output window
	A dialog	the Settings dialog
	A menu selection	select Enable Programmer
Quotes	A field name in a window or dialog	"Save project before build"
Underlined, italic text with right angle bracket	A menu path	<u><i>File>Save</i></u>
Bold characters	A dialog button	Click OK
	A tab	Click the Power tab
N'Rnnnn	A number in verilog format, where N is the total number of digits, R is the radix and n is a digit.	4'b0010, 2'hF1
Text in angle brackets < >	A key on the keyboard	Press <Enter>, <F1>
Courier New font:		
Plain Courier New	Sample source code	#define START
	Filenames	autoexec.bat
	File paths	c:\mcc18\h
	Keywords	_asm, _endasm, static
	Command-line options	-Opa+, -Opa-
	Bit values	0, 1
	Constants	0xFF, 'A'
Italic Courier New	A variable argument	<i>file.o</i> , where <i>file</i> can be any valid filename
Square brackets []	Optional arguments	mcc18 [options] <i>file</i> [options]
Curly brackets and pipe character: { }	Choice of mutually exclusive arguments; an OR selection	errorlevel {0 1}

RECOMMENDED READING

This user's guide describes how to use MCP1630 Automotive Input Boost Converter Demo Board. The following Microchip documents are available and recommended as supplemental reference resources.

MCP1630/MCP1630V Data Sheet, "High-Speed, Microcontroller-Adaptable, Pulse Width Modulator" (DS21896)

This data sheet provides detailed information regarding the MCP1630/MCP1630V product family.

PIC12F683 Data Sheet, "8-Pin Flash-Based, 8-Bit CMOS Microcontrollers with Nano Watt Technology" (DS41211)

This data sheet provides detailed information regarding the PIC12F683 product family.

THE MICROCHIP WEB SITE

Microchip provides online support via our web site at www.microchip.com. This web site is used as a means to make files and information easily available to customers. Accessible by using your favorite Internet browser, the web site contains the following information:

- **Product Support** – Data sheets and errata, application notes and sample programs, design resources, user's guides and hardware support documents, latest software releases and archived software
- **General Technical Support** – Frequently Asked Questions (FAQs), technical support requests, online discussion groups, Microchip consultant program member listing
- **Business of Microchip** – Product selector and ordering guides, latest Microchip press releases, listing of seminars and events, listings of Microchip sales offices, distributors and factory representatives

CUSTOMER SUPPORT

Users of Microchip products can receive assistance through several channels:

- Distributor or Representative
- Local Sales Office
- Field Application Engineer (FAE)
- Technical Support

Customers should contact their distributor, representative or field application engineer (FAE) for support. Local sales offices are also available to help customers. A listing of sales offices and locations is included in the back of this document.

Technical support is available through the web site at: <http://support.microchip.com>

DOCUMENT REVISION HISTORY

Revision B (June 2007)

- Updated Bill of Materials (BOM) for C12, C13, and L1
- Add disclaimer to Bill of Materials regarding RoHS-Compliant part numbers.

Revision A (April 2006)

- Initial Release of this Document.

MCP1630 Automotive Input Boost Converter Demo Board User's Guide

NOTES:

Chapter 1. Product Overview

1.1 INTRODUCTION

The proliferation of distributed power supplies is expected to accelerate their use in future generation cars. Distributed power supplies or "point-of-load" power supplies are being used increasingly throughout. These Power Supply Units (PSUs) are responsible for stepping up (or down) a 12V nominal bus, to power a multitude of subsystems. These include telematics/navigation systems, power seats and doors, interior and exterior lighting, electronic braking and engine management control.

Many automotive and industrial applications require higher voltages than are available on the input power supply rail. Supply voltages required for these systems can range from 36V (power seats and windows) to 1.8V (to drive low-voltage microprocessors). In addition, depending on where the PSU operates on the automotive power bus, it may be required to perform under very stringent power requirements.

Automotive subsystems with their inherent high voltage transients and high efficiency requirements place increasing demands on power supply designs. These supplies must provide high power, high efficiency and low noise from a very compact footprint and must maintain a high efficiency over a wide range of operational input voltages.

The MCP1630/V high-speed, microcontroller-adaptable Pulse Width Modulator (PWM) is capable of maintaining output regulation with no adverse effects on system performance or reliability. The MCP1630 Automotive Input Boost Converter Demo Board provides a better choice for automotive application design and high efficiency.

This chapter covers the following topics.

- What is the MCP1630 Automotive Input Boost Converter Demo Board?
- What the MCP1630 Automotive Input Boost Converter Demo Board Kit includes.

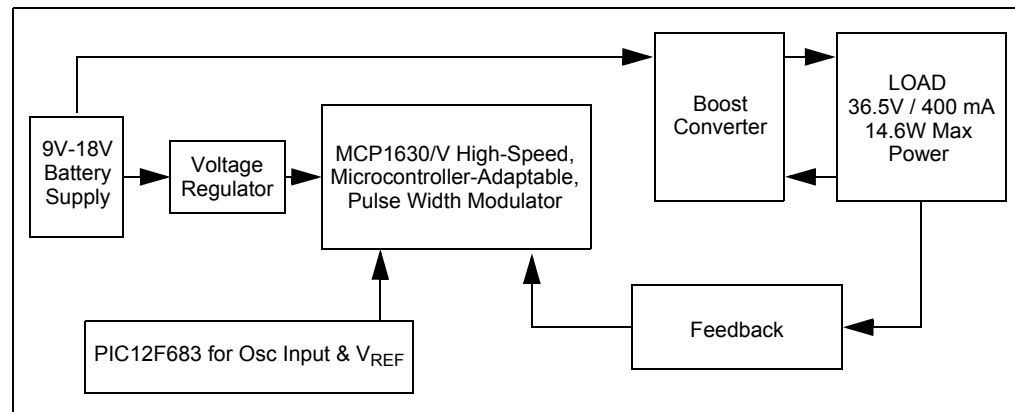

FIGURE 1-1: MCP1630 Automotive Input Boost Converter Demo Board Block Diagram.

1.2 WHAT IS THE MCP1630 AUTOMOTIVE INPUT BOOST CONVERTER DEMO BOARD?

The MCP1630 Automotive Input Boost Converter Demo Board demonstrates the use of a conventional boost topology with automotive input. The board also serves as a platform to evaluate the MCP1630/V devices.

The MCP1630/V inputs were developed to be easily attached to the I/O of a microcontroller. The Microcontroller Unit (MCU) supplies the oscillator pulses and reference voltage (V_{REF}) to the MCP1630/V devices to provide the most flexible and adaptable power system. The power system switching frequency and maximum duty cycle are set using the I/O of the MCU. The reference input to the high-speed PWM can be external, a D/A Converter (DAC) output or as simple as an I/O output from the MCU. This enables the power system to adapt to many external signals and variables in order to optimize performance and facilitate calibration.

This board utilizes Microchip's MCP1630/V (high-speed PICmicro[®] MCU PWM) integrated with PIC12F683 (Flash MCU SOIC8) in automotive input application. Under normal operation, the vehicle voltage at the supply lines ranges between 9V-18V (12V system). The converter is capable of delivering an output voltage of 36.5V at 400 mA load current with maximum power of 14.6W. The line and load regulation is within the regulation band of 3%.

1.3 WHAT THE MCP1630 AUTOMOTIVE INPUT BOOST CONVERTER DEMO BOARD KIT INCLUDES

This MCP1630 Automotive Input Boost Converter Demo Board kit includes:

- MCP1630 Automotive Input Boost Converter Demo Board (102-00095)
- Analog and Interface Products Demonstration Boards CD-ROM (DS21912)
 - MCP1630 Automotive Input Boost Converter Demo Board User's Guide (DS51608)



MCP1630 AUTOMOTIVE INPUT BOOST CONVERTER DEMO BOARD USER'S GUIDE

Chapter 2. Installation and Operation

2.1 INTRODUCTION

The MCP1630 Automotive Input Boost Converter Demo Board demonstrates Microchip's high-speed pulse width modulator used for automotive applications. When used in conjunction with a microcontroller, the MCP1630/V devices will control the power system duty cycle to provide regulated output voltage. The PIC12F683 microcontroller is used to provide oscillator pulses at switching frequency of 500 kHz and set maximum duty cycle. The MCP1630/V devices generate duty cycles based on various external inputs. External signals include the input oscillator pulses from PIC12F683, the reference voltage and the feedback voltage. The output signal is a square wave pulse given to drive the MOSFET.

The PIC12F683 microcontroller is programmable, allowing the user to modify or develop their own firmware routines to further evaluate the MCP1630/V devices in this application.

2.2 FEATURES

The MCP1630 Automotive Input Boost Converter Demo Board has the following features:

- Compact size for an output power of 14.6W
- Tight line and load regulation and high efficiency over entire operating input voltage range
- PIC12F683 is used to generate reference voltage and oscillator signal at 500 kHz frequency at maximum duty cycle
- Proprietary features can be added by modifying the firmware contained in the PIC12F683
- Factory programmed source code is available

2.3 GETTING STARTED

The MCP1630 Automotive Input Boost Converter Demo Board is fully assembled and tested for automotive input. The board requires the use of an external input voltage source (+9V to 18V) and external load.

2.3.1 Power Input and Output Connection

2.3.1.1 POWERING THE MCP1630 AUTOMOTIVE INPUT BOOST CONVERTER DEMO BOARD

1. Connect the positive side of the input source (+) to TP1.
2. Connect the negative or return side (-) of the input source to TP2. Refer to Figure 2-1. The input voltage source should be limited to the 0V to +18V range. For normal operation, the input voltage should be between +9V to +18V. The input voltage must not exceed an absolute maximum of +20V.

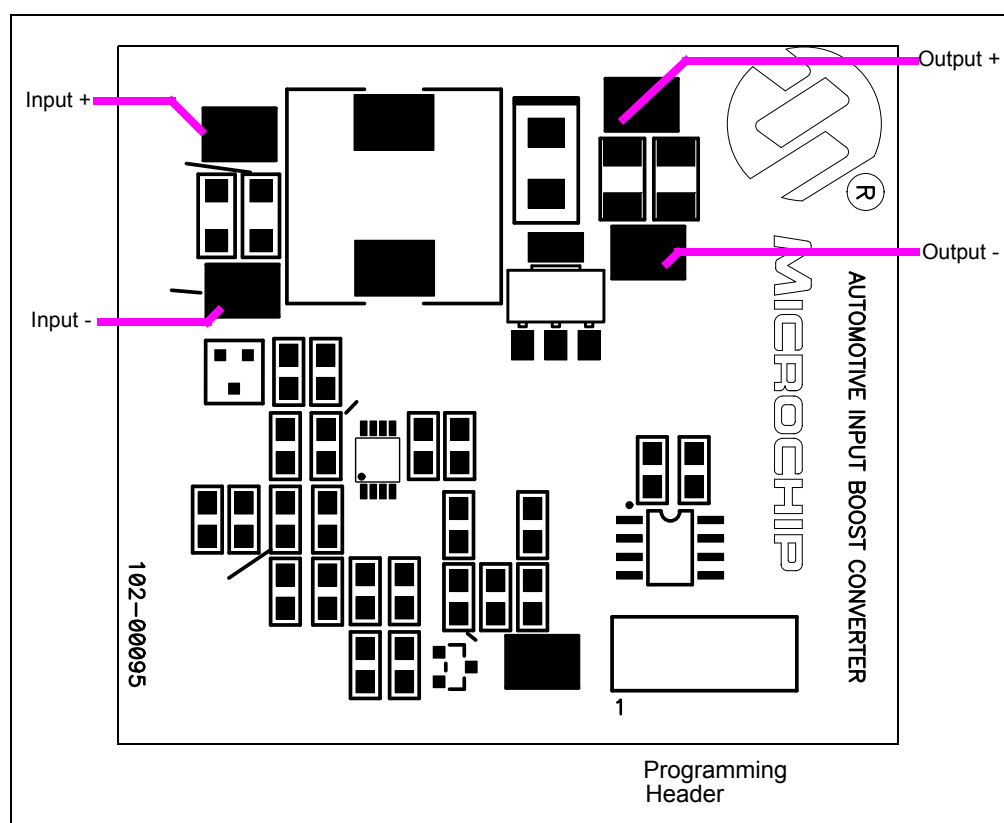

FIGURE 2-1: Set-up Configuration Diagram.

2.3.1.2 APPLY LOAD TO MCP1630 AUTOMOTIVE INPUT BOOST CONVERTER DEMO BOARD

A variable resistive load can be used to verify the line and load regulation. The load resistance is connected between the points TP3 and TP4. To measure the output voltage, connect the common point of a multimeter to TP4 and the positive terminal to TP3. By varying the load, the load regulation can be verified by measuring the output voltage over the entire load range of 0 mA to 400 mA. Similarly, the line regulation can be calculated by varying the line voltage from 9V to 18V and checking the output voltage.

Evaluating the Application

The best way to evaluate the MCP1630 is to dig into the circuit and measure voltages and currents with a Digital Voltage Meter (DVM) and probe the board with an oscilloscope.

The firmware program in the PIC12F683 can also be edited to modify the operation of the application.

Firmware

The PIC12F683 comes pre-programmed with firmware to operate the system as described above. The file listing and firmware flow diagram are shown in **Appendix C. "Demo Board Firmware"**.

The program is fairly simple and straight forward. There is an initialization routine at the beginning of the program.

The TRISIO register controls the direction of GPIO pins, and is configured to set GP2 (oscillator pulses to the MCP1630/V) and GP5 (V_{REF} voltage to MCP1630/V) as an output port.

The Capture/Compare/PWM (CCP) module contains a 16-bit register which can operate in PWM mode. The PWM period can be calculated by writing to the PR2 register. The PWM duty cycle is specified by writing to the CCPR1L register and to the CCP1CON <5:4> bits. Up to 10-bit resolution is available. The CCPR1L contains the eight MSbs and the CCP1CON <5:4> contains the two LSbs. This 10-bit value is represented by CCPR1L:CCP1CON<5:4>. The switching frequency is set to 500 kHz.

The user can obtain different output voltages by programming the MCU to obtain different V_{REF} voltages.

Programming

Header J1 is provided for in-circuit programming. This is an optional feature since the MCP1630 Automotive Input Boost Converter Demo Board comes pre-programmed with firmware to operate the system. The PIC12F683 can be reprogrammed with the Baseline Flash Microcontroller Programmer (BFMP).

MCP1630 Automotive Input Boost Converter Demo Board User's Guide

NOTES:



MCP1630 AUTOMOTIVE INPUT BOOST CONVERTER DEMO BOARD USER'S GUIDE

Appendix A. Schematic and Layouts

A.1 INTRODUCTION

This appendix contains the following schematics and layouts for the MCP1630 Automotive Input Boost Converter Demo Board:

- Board – Schematic
- Board – Top Silk Layer
- Board – Top Metal Layer
- Board – Bottom Metal Layer

A.2 BOARD – SCHEMATIC

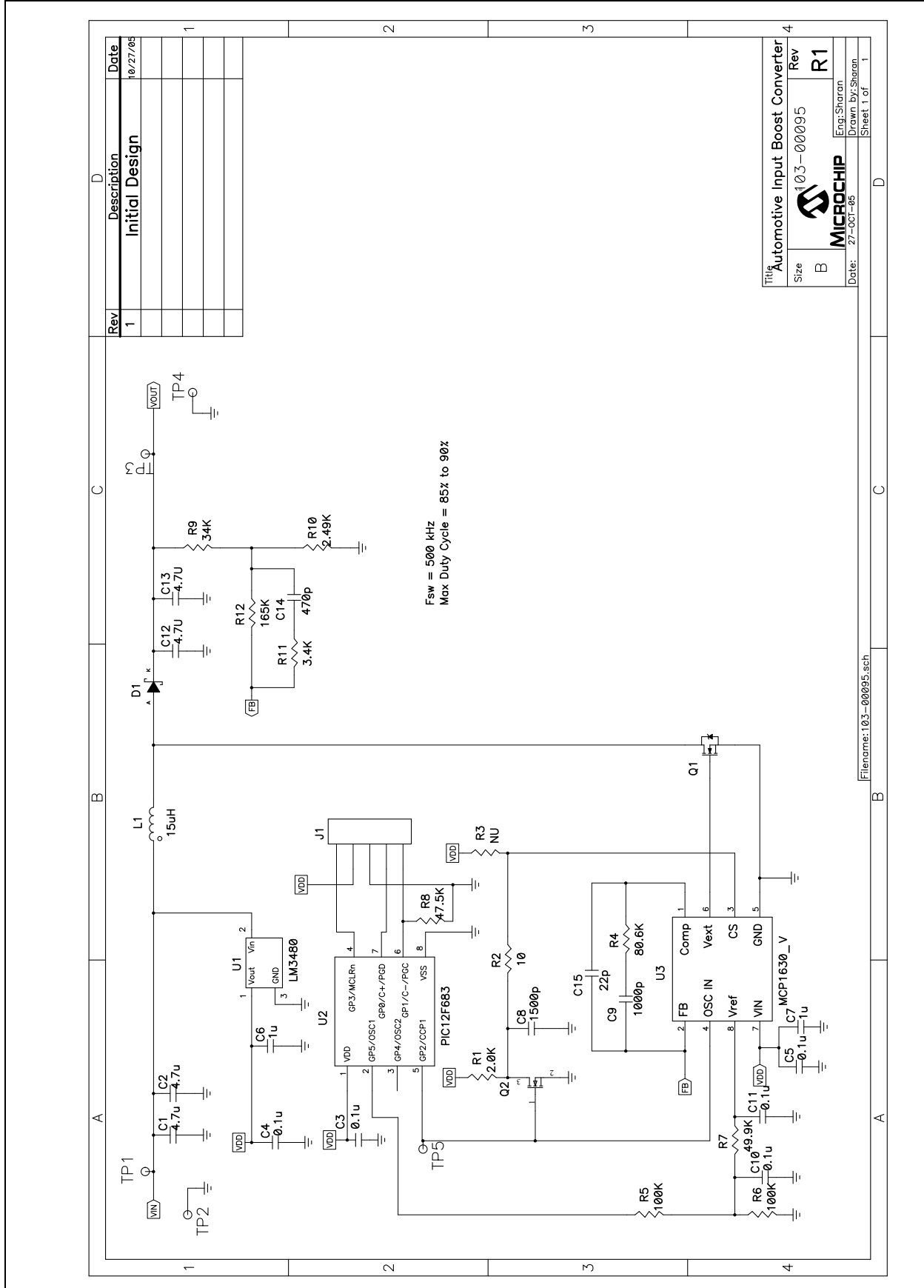

A.3 BOARD – TOP SILK LAYER

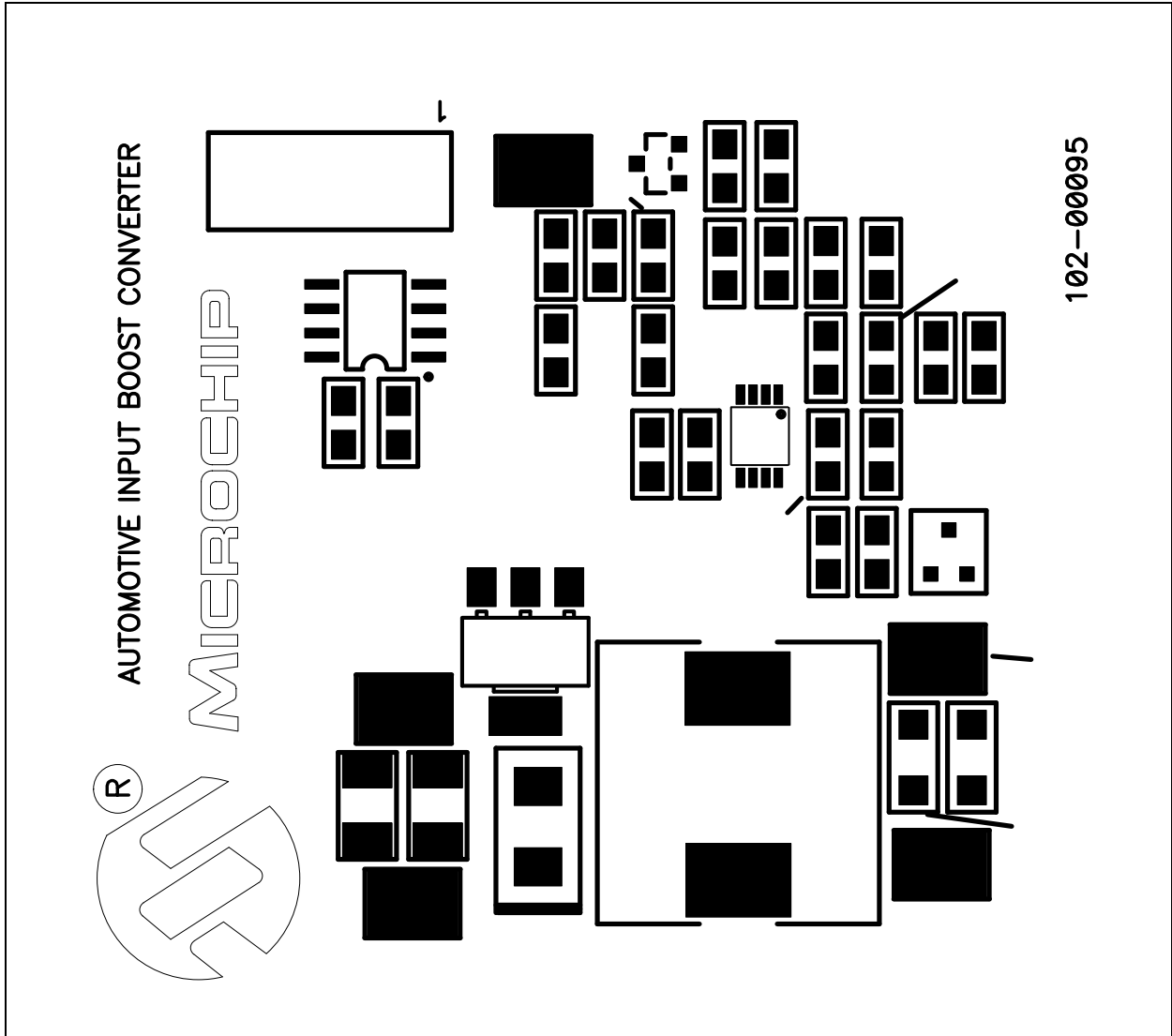

A.4 BOARD – TOP METAL LAYER

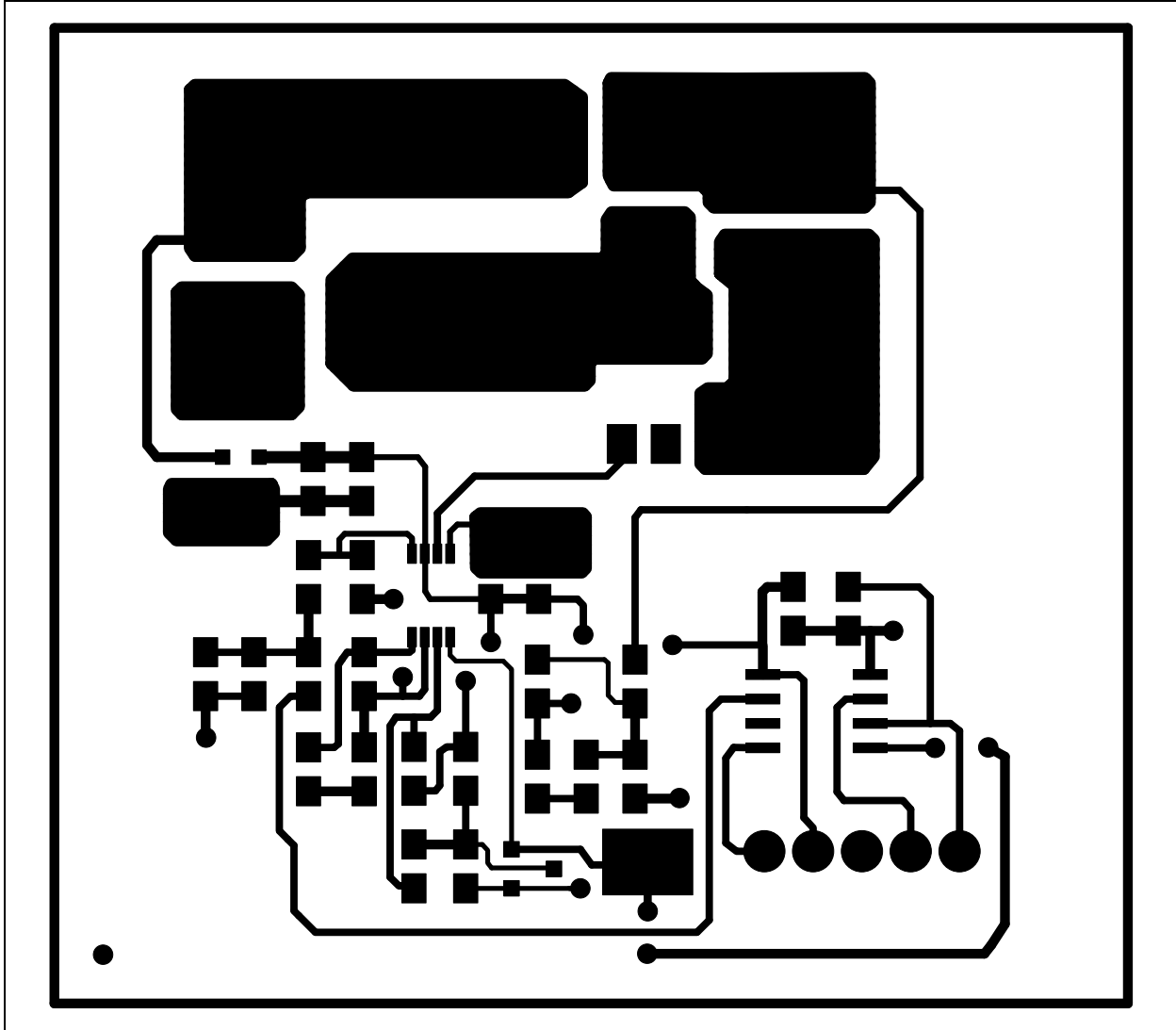

A.5 BOARD – BOTTOM METAL LAYER

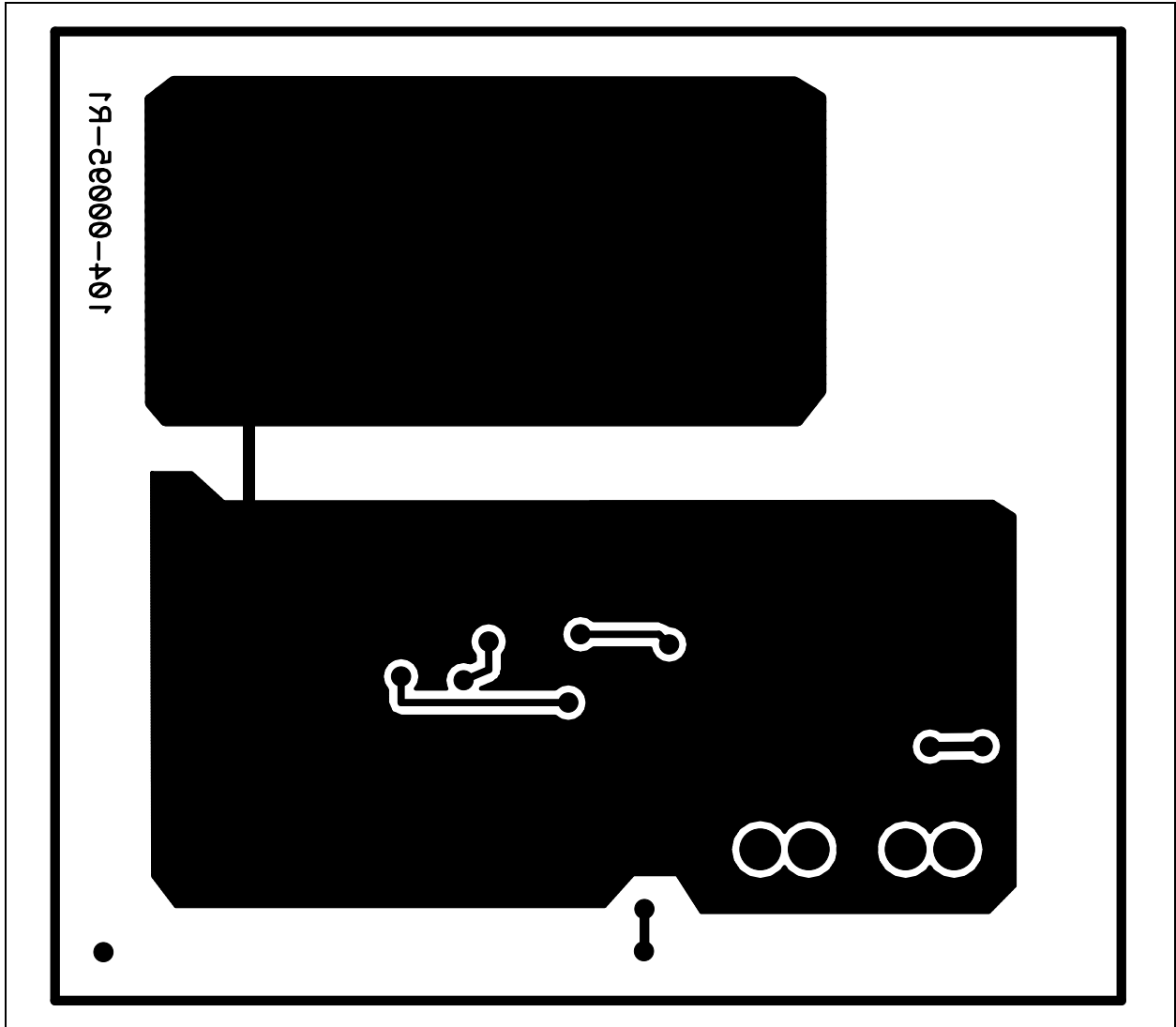

MCP1630 Automotive Input Boost Converter Demo Board User's Guide

NOTES:



MCP1630 AUTOMOTIVE INPUT BOOST CONVERTER DEMO BOARD USER'S GUIDE

Appendix B. Bill Of Materials (BOM)

TABLE B-1: BILL OF MATERIALS (BOM)

Qty	Reference	Description	Manufacturer	Part Number
2	C1, C2	Cap 4.7uF 25V Ceramic X5R 1206	Panasonic® - ECG	ECJ-3YB1E475M
5	C3, C4, C5, C10, C11	Cap 0.1uF 16V Ceramic X7R 0805	Panasonic - ECG	ECJ-2VB1C104K
2	C6, C7	Cap 1uF 16V Ceramic X7R 0805	Panasonic - ECG	ECJ-2FB1C105K
1	C8	Cap 1500pF 100V Ceramic X7R 0805	Panasonic - ECG	ECJ-2VB2A152K
1	C9	Cap 1000pF 50V Cerm Chip 0805	Panasonic - ECG	ECJ-2VC1H102J
2	C12, C13	Cap Cer 4.7uF 50V 10% X7R 1210	Murata	GRM32ER71H475KA88L
1	C14	Cap 470pF 50V Cerm Chip 0805 SMD	Panasonic - ECG	ECJ-2VC1H471J
1	C15	Cap 22pF 50V Cerm Chip 0805 SMD	Panasonic - ECG	ECJ-2VC1H220J
1	D1	Diode Schottky 60V 1A SMB	International Rectifier	10BQ060
1	J1	Conn Header 5 Pos.100 Vert Tin	Molex	22-03-2051
1	L1	Inductor Shielded Drum Power 15uH SMD	Coiltronics	DR125-150-R
1	Q1	MOSFET N-CH 55V 3.1A SOT-23	International Rectifier	IRLL024N
1	Q2	MOSFET N-CH 60V 280mA SOT-33	Fairchild Semiconductor®	NDS7002A
1	R1	Res 2.00K Ohm 1/8W 1% 0805 SMD	Panasonic - ECG	ERJ-6ENF2001V
1	R2	Res 10.0K Ohm 1/8W 1% 0805 SMD	Panasonic - ECG	ERJ-6ENF10R0V
1	R3	Not Used	—	—
1	R4	Res 80.6K Ohm 1/8W 1% 0805 SMD	Panasonic - ECG	ERJ-6ENF8062V
2	R5, R6	Res 100K Ohm 1/8W 1% 0805 SMD	Panasonic - ECG	ERJ-6ENF1003V
1	R7	Res 49.9K Ohm 1/8W 1% 0805 SMD	Panasonic - ECG	ERJ-6ENF4992V
1	R8	Res 47.5K Ohm 1/8W 1% 0805 SMD	Panasonic - ECG	ERJ-6ENF4752V
1	R9	Res 34.0K Ohm 1/8W 1% 0805 SMD	Panasonic - ECG	ERJ-6ENF3402V
1	R10	Res 2.49K Ohm 1/8W 1% 0805 SMD	Panasonic - ECG	ERJ-6ENF2491V
1	R11	Res 3.40K Ohm 1/8W 1% 0805 SMD	Panasonic - ECG	ERJ-6ENF3401V
1	R12	Res 165K Ohm 1/8W 1% 0805 SMD	Panasonic - ECG	ERJ-6ENF1653V
5	TP1,TP2, TP3,TP4, TP5	PC Test point compact SMT	Keystone Electronics®	5016
1	U1	IC 5.0 100 mA LDO Vreg SOT23	National Semiconductor®	LM3480IM3-5.0
1	U2	IC MCU Flash 2KX14 8SOIC	Microchip Technology Inc	PIC12F683-I/SN
1	U3	IC PWM HS MCU-Adaptable 8MSOP	Microchip Technology Inc	MCP1630V-E/MS

Note 1: The components listed in this Bill of Materials are representative of the PCB assembly. The released BOM used in manufacturing uses all RoHS-compliant components.

NOTES:

Appendix C. Demo Board Firmware

C.1 DEVICE FIRMWARE

For the latest copy of the MCP1630 Automotive Input Boost Converter Demo Board User's Guide firmware, visit our web site at www.microchip.com

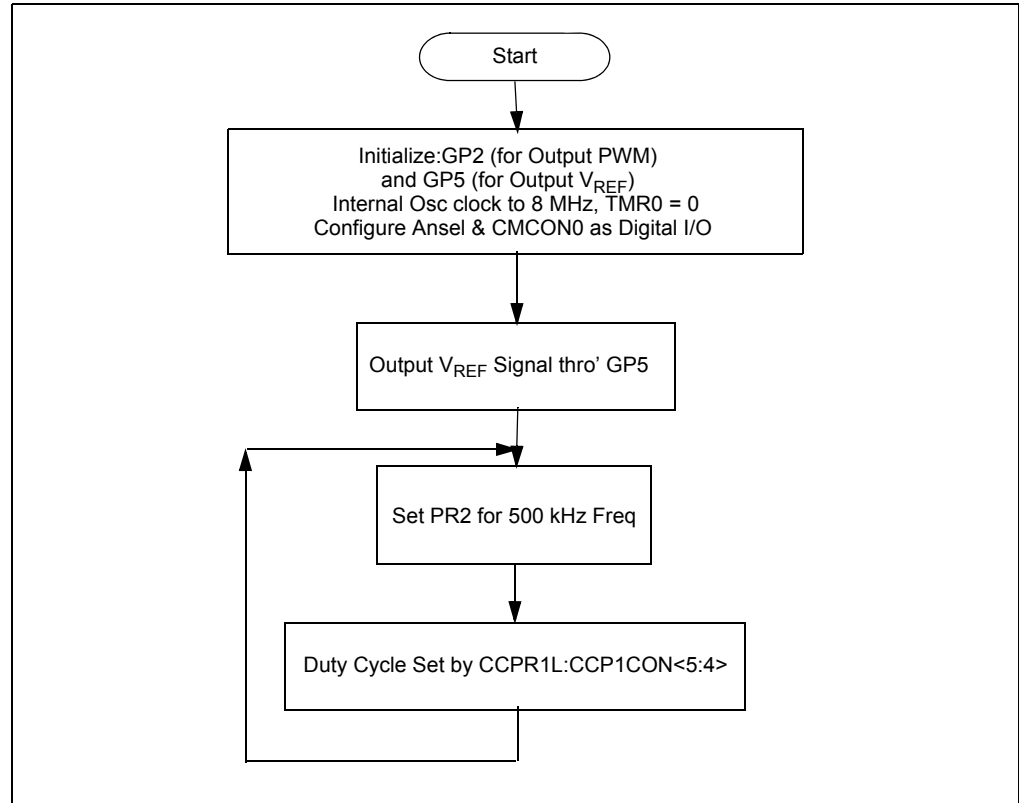

FIGURE C-1: *Firmware Flowchart.*



WORLDWIDE SALES AND SERVICE

AMERICAS

Corporate Office
2355 West Chandler Blvd.
Chandler, AZ 85224-6199
Tel: 480-792-7200
Fax: 480-792-7277
Technical Support:
<http://support.microchip.com>
Web Address:
www.microchip.com

Atlanta
Duluth, GA
Tel: 678-957-9614
Fax: 678-957-1455

Boston
Westborough, MA
Tel: 774-760-0087
Fax: 774-760-0088

Chicago
Itasca, IL
Tel: 630-285-0071
Fax: 630-285-0075

Dallas
Addison, TX
Tel: 972-818-7423
Fax: 972-818-2924

Detroit
Farmington Hills, MI
Tel: 248-538-2250
Fax: 248-538-2260

Kokomo
Kokomo, IN
Tel: 765-864-8360
Fax: 765-864-8387

Los Angeles
Mission Viejo, CA
Tel: 949-462-9523
Fax: 949-462-9608

Santa Clara
Santa Clara, CA
Tel: 408-961-6444
Fax: 408-961-6445

Toronto
Mississauga, Ontario,
Canada
Tel: 905-673-0699
Fax: 905-673-6509

ASIA/PACIFIC

Asia Pacific Office
Suites 3707-14, 37th Floor
Tower 6, The Gateway
Harbour City, Kowloon
Hong Kong
Tel: 852-2401-1200
Fax: 852-2401-3431

Australia - Sydney
Tel: 61-2-9868-6733
Fax: 61-2-9868-6755

China - Beijing
Tel: 86-10-8528-2100
Fax: 86-10-8528-2104

China - Chengdu
Tel: 86-28-8665-5511
Fax: 86-28-8665-7889

China - Fuzhou
Tel: 86-591-8750-3506
Fax: 86-591-8750-3521

China - Hong Kong SAR
Tel: 852-2401-1200
Fax: 852-2401-3431

China - Qingdao
Tel: 86-532-8502-7355
Fax: 86-532-8502-7205

China - Shanghai
Tel: 86-21-5407-5533
Fax: 86-21-5407-5066

China - Shenyang
Tel: 86-24-2334-2829
Fax: 86-24-2334-2393

China - Shenzhen
Tel: 86-755-8203-2660
Fax: 86-755-8203-1760

China - Shunde
Tel: 86-757-2839-5507
Fax: 86-757-2839-5571

China - Wuhan
Tel: 86-27-5980-5300
Fax: 86-27-5980-5118

China - Xian
Tel: 86-29-8833-7250
Fax: 86-29-8833-7256

ASIA/PACIFIC

India - Bangalore
Tel: 91-80-4182-8400
Fax: 91-80-4182-8422

India - New Delhi
Tel: 91-11-4160-8631
Fax: 91-11-4160-8632

India - Pune
Tel: 91-20-2566-1512
Fax: 91-20-2566-1513

Japan - Yokohama
Tel: 81-45-471-6166
Fax: 81-45-471-6122

Korea - Gumi
Tel: 82-54-473-4301
Fax: 82-54-473-4302

Korea - Seoul
Tel: 82-2-554-7200
Fax: 82-2-558-5932 or
82-2-558-5934

Malaysia - Penang
Tel: 60-4-646-8870
Fax: 60-4-646-5086

Philippines - Manila
Tel: 63-2-634-9065
Fax: 63-2-634-9069

Singapore
Tel: 65-6334-8870
Fax: 65-6334-8850

Taiwan - Hsin Chu
Tel: 886-3-572-9526
Fax: 886-3-572-6459

Taiwan - Kaohsiung
Tel: 886-7-536-4818
Fax: 886-7-536-4803

Taiwan - Taipei
Tel: 886-2-2500-6610
Fax: 886-2-2508-0102

Thailand - Bangkok
Tel: 66-2-694-1351
Fax: 66-2-694-1350

EUROPE

Austria - Wels
Tel: 43-7242-2244-39
Fax: 43-7242-2244-393

Denmark - Copenhagen
Tel: 45-4450-2828
Fax: 45-4485-2829

France - Paris
Tel: 33-1-69-53-63-20
Fax: 33-1-69-30-90-79

Germany - Munich
Tel: 49-89-627-144-0
Fax: 49-89-627-144-44

Italy - Milan
Tel: 39-0331-742611
Fax: 39-0331-466781

Netherlands - Drunen
Tel: 31-416-690399
Fax: 31-416-690340

Spain - Madrid
Tel: 34-91-708-08-90
Fax: 34-91-708-08-91

UK - Wokingham
Tel: 44-118-921-5869
Fax: 44-118-921-5820



Компания «ЭлектроПласт» предлагает заключение долгосрочных отношений при поставках импортных электронных компонентов на взаимовыгодных условиях!

Наши преимущества:

- Оперативные поставки широкого спектра электронных компонентов отечественного и импортного производства напрямую от производителей и с крупнейших мировых складов;
- Поставка более 17-ти миллионов наименований электронных компонентов;
- Поставка сложных, дефицитных, либо снятых с производства позиций;
- Оперативные сроки поставки под заказ (от 5 рабочих дней);
- Экспресс доставка в любую точку России;
- Техническая поддержка проекта, помощь в подборе аналогов, поставка прототипов;
- Система менеджмента качества сертифицирована по Международному стандарту ISO 9001;
- Лицензия ФСБ на осуществление работ с использованием сведений, составляющих государственную тайну;
- Поставка специализированных компонентов (Xilinx, Altera, Analog Devices, Intersil, Interpoint, Microsemi, Aeroflex, Peregrine, Syfer, Eurofarad, Texas Instrument, Miteq, Cobham, E2V, MA-COM, Hittite, Mini-Circuits, General Dynamics и др.);

Помимо этого, одним из направлений компании «ЭлектроПласт» является направление «Источники питания». Мы предлагаем Вам помощь Конструкторского отдела:

- Подбор оптимального решения, техническое обоснование при выборе компонента;
- Подбор аналогов;
- Консультации по применению компонента;
- Поставка образцов и прототипов;
- Техническая поддержка проекта;
- Защита от снятия компонента с производства.



Как с нами связаться

Телефон: 8 (812) 309 58 32 (многоканальный)

Факс: 8 (812) 320-02-42

Электронная почта: org@eplast1.ru

Адрес: 198099, г. Санкт-Петербург, ул. Калинина, дом 2, корпус 4, литера А.