

### THAT 2180A, 2180B, 2180C

#### FEATURES

- Wide Dynamic Range: >120 dB
- Wide Gain Range: >130 dB
- Exponential (dB) Gain Control
- Low Distortion: < 0.01 % (2180A)
- Wide Gain-Bandwidth: 20 MHz
- Dual Gain-Control Ports (pos/neg)
- Pin-Compatible with 2150-Series

#### APPLICATIONS

- Faders
- Panners
- Compressors
- Expanders
- Equalizers
- Filters
- Oscillators
- Automation Systems

#### Description

THAT 2180 Series integrated-circuit voltage controlled amplifiers (VCAs) are very high-performance current-in/current-out devices with two opposing-polarity, voltage-sensitive control ports. They offer wide-range exponential control of gain and attenuation with low signal distortion. The parts are trimmed at wafer stage for low THD and control-voltage feedthrough without further adjustment.

The VCA design takes advantage of a fully complementary dielectric isolation process which offers closely matched NPN/PNP pairs, to deliver discrete performance at IC prices. The parts are available in three grades, selected for factory trimmed distortion, allowing the user to optimize cost vs. performance. The 2180 Series is available in an 8-pin single-in-line (SIP) package.

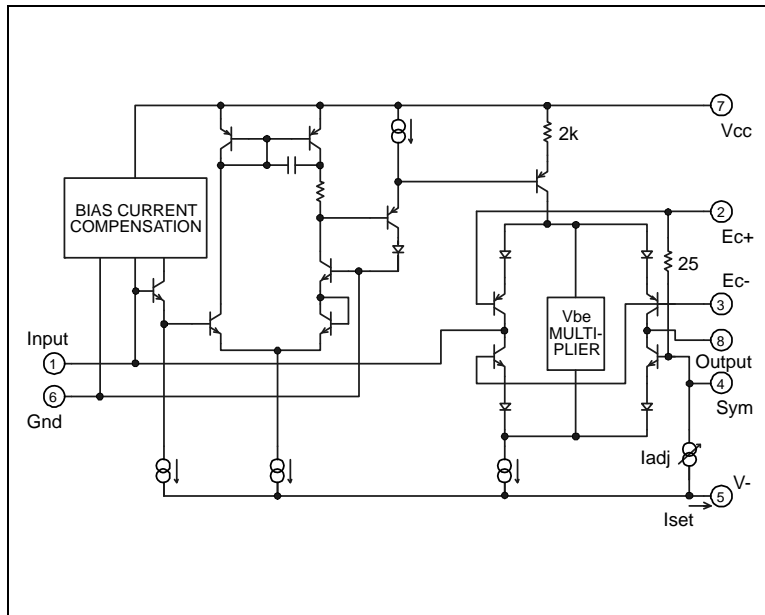

Figure 1. 2180-series equivalent circuit diagram

Pin Name	Pin Number
Input	1
Ec+	2
Ec-	3
Sym	4
V-	5
Gnd	6
V+	7
Output	8

Table 1. Pin assignments

Max THD @ 1V, 1 kHz, 0 dB	Plastic SIP
0.01%	2180AL08-U
0.02%	2180BL08-U
0.05%	2180CL08-U

Table 2. Ordering information

**SPECIFICATIONS<sup>1</sup>****Absolute Maximum Ratings<sup>2,3</sup>**

Positive Supply Voltage ( $V_{CC}$ )	+20 V	Power Dissipation ( $P_D$ ) ( $T_A = 75^\circ\text{C}$ )	330 mW
Negative Supply Voltage ( $V_{EE}$ )	-20 V	Operating Temperature Range ( $T_{OP}$ )	0 to +70 °C
Supply Current ( $I_{CC}$ )	10 mA	Storage Temperature Range ( $T_{ST}$ )	-40 to +125 °C
Maximum $\Delta E_C$ $E_{C+} - (E_C)$	$\pm 1$ V		

**Recommended Operating Conditions**

Parameter	Symbol	Conditions	<u>2180A</u>			<u>2180B</u>			<u>2180C</u>			Units
			Min	Typ	Max	Min	Typ	Max	Min	Typ	Max	
Positive Supply Voltage	$V_{CC}$		+4	+15	+18	+4	+15	+18	+4	+15	+18	V
Negative Supply Voltage	$V_{EE}$		-4	-15	-18	-4	-15	-18	-4	-15	-18	V
Bias Current	$I_{SET}$	$V_{CC} - V_{EE} = 30$ V	1	2.4	5	1	2.4	5	1	2.4	5	mA
Signal Current	$I_{IN} + I_{OUT}$	$I_{SET} = 2.4$ mA	—	0.35	1.5	—	0.35	1.5	—	0.35	1.5	mA <sub>rms</sub>

**Electrical Characteristics<sup>2</sup>**

Parameter	Symbol	Conditions	<u>2180A</u>			<u>2180B</u>			<u>2180C</u>			Units	
			Min	Typ	Max	Min	Typ	Max	Min	Typ	Max		
Supply Current	$I_{CC}$	No signal	—	2.4	4	—	2.4	4	—	2.4	4	mA	
Equiv. Input Bias Current	$I_B$	No Signal	—	2	10	—	2	12	—	2	15	nA	
Input Offset Voltage	$V_{OFF(IN)}$	No Signal	—	$\pm 5$	—	—	$\pm 5$	—	—	$\pm 5$	—	mV	
Output Offset Voltage	$V_{OFF(OUT)}$	$R_{out} = 20$ k $\Omega$	—	0.5	1	—	1	2	—	1.5	3	mV	
		0 dB gain	—	1	3	—	1.5	4	—	3	10	mV	
		+15 dB gain	—	3	12	—	5	15	—	9	30	mV	
		+30 dB gain	—	3	12	—	5	15	—	9	30	mV	
Gain Cell Idling Current	$I_{IDLE}$		—	20	—	—	20	—	—	20	—	$\mu$ A	
Gain-Control Constant	$E_{C+}/\text{Gain (dB)}$	$T_A = 25^\circ\text{C}$ ( $T_{CHIP} \cong 35^\circ\text{C}$ )	6.0	6.1	6.2	6.0	6.1	6.2	6.0	6.1	6.2	mV/dB	
		-60 dB < gain < +40 dB	-6.2	-6.1	-6.0	-6.2	-6.1	-6.0	-6.2	-6.1	-6.0	-6.0	mV/dB
		Pin 2 (Fig. 14)											
	$E_C/\text{Gain (dB)}$	Pin 3											
Gain-Control TempCo	$\Delta E_C / \Delta T_{CHIP}$	Ref $T_{CHIP} = 27^\circ\text{C}$	—	+0.33	—	—	+0.33	—	—	+0.33	—	%/°C	
Gain-Control Linearity		-60 to +40 dB gain	—	0.5	2	—	0.5	2	—	0.5	2	%	
1 kHz Off Isolation		$E_{C+} = -360\text{mV}, E_C = +360\text{mV}$	110	115	—	110	115	—	110	115	—	dB	
Output Noise	$e_{n(OUT)}$	20 Hz ~ 20 kHz	—	-98	-97	—	-98	-96	—	-98	-95	dBV	
		$R_{out} = 20\text{k}\Omega$	—	-88	-86	—	-88	-85	—	-88	-84	dBV	
		0 dB gain	—	-88	-86	—	-88	-85	—	-88	-84	dBV	
+15 dB gain	—	-88	-86	—	-88	-85	—	-88	-84	dBV			
Voltage at V-	$V_V$	No Signal	-3.1	-2.85	-2.6	-3.1	-2.85	-2.5	-3.1	-2.85	-2.6	V	

1. All specifications are subject to change without notice.

2. Unless otherwise noted,  $T_A = 25^\circ\text{C}$ ,  $V_{CC} = +15\text{V}$ ,  $V_{EE} = -15\text{V}$ .

3. Stresses above those listed under "Absolute Maximum Ratings" may cause permanent damage to the device. These are stress ratings only; the functional operation of the device at these or any other conditions above those indicated in the operational sections of this specification is not implied. Exposure to absolute maximum rating conditions for extended periods may affect device reliability.

<b>Electrical Characteristics (con't)<sup>2</sup></b>												
Parameter	Symbol	Conditions	2180A			2180B			2180C			Units
			Min	Typ	Max	Min	Typ	Max	Min	Typ	Max	
Total Harmonic Distortion THD		1 kHz, No External Trim										
		$V_{IN} = 0$ dBV, 0 dB gain	—	0.005	0.010	—	0.010	0.020	—	0.030	0.050	%
		$V_{IN} = +10$ dBV, -15 dB gain	—	0.020	0.030	—	0.030	0.040	—	0.040	0.070	%
		$V_{IN} = -5$ dBV, +15 dB gain	—	0.020	0.030	—	0.030	0.040	—	0.040	0.070	%
Slew Rate		$R_{IN} = R_{OUT} = 20$ k $\Omega$	—	12	—	—	12	—	—	12	—	V/ $\mu$ s
Gain at 0 V Control Voltage		$E_{C-} = 0$ mV	-0.1	0.0	+0.1	-0.15	0.0	+0.15	-0.2	0.0	+0.2	dB

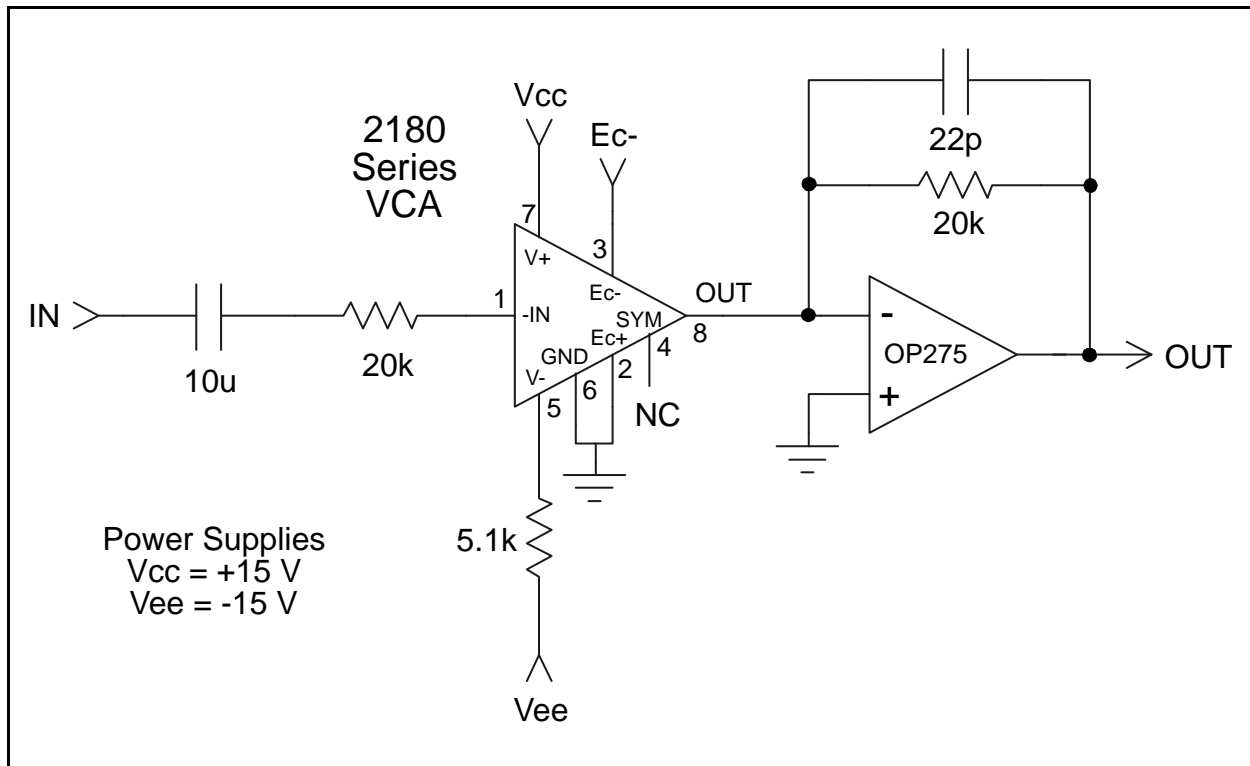

Figure 2. Typical Application Circuit

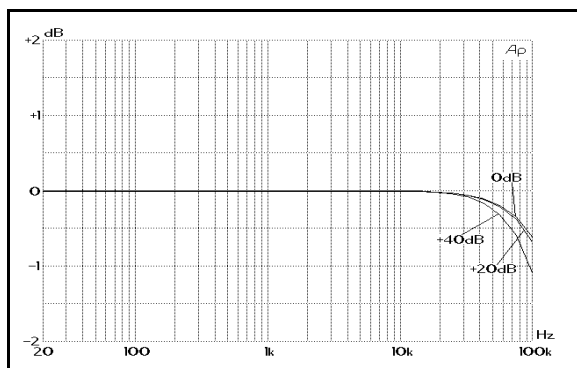

Figure 3. 2180-series Frequency Response vs. Gain

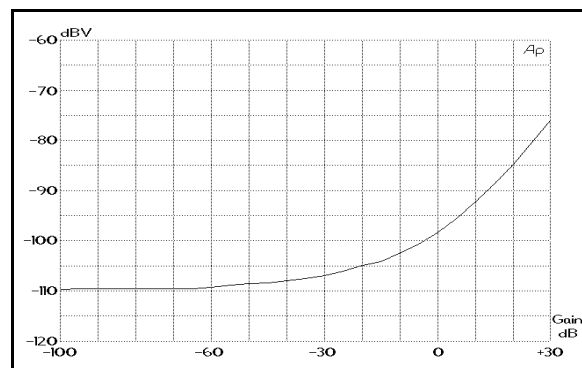

Figure 4. 2180-series Noise (20kHz NBW) vs. Gain

## Theory of Operation<sup>4</sup>

The THAT 2180 Series VCAs are designed for high performance in audio-frequency applications requiring exponential gain control, low distortion, wide dynamic range and low control-voltage feedthrough. These parts control gain by converting an input current signal to a bipolar logged voltage, adding a dc control voltage, and reconverting the summed voltage back to a current through a bipolar antilog circuit.

Figure 5 presents a considerably simplified internal circuit diagram of the IC. The ac input signal current flows in pin 1, the input pin. An internal operational transconductance amplifier (OTA) works to maintain pin 1 at a virtual ground potential by driving the emitters of Q1 and (through the Voltage Bias Generator) Q3. Q3/D3 and Q1/D1 act to log the input current, producing a voltage, V3, which represents the bipolar logarithm of the input current. (The voltage at the junction of D1 and D2 is the same as V3, but shifted by four forward  $V_{be}$  drops.)

### Gain Control

Since pin 8, the output, is usually connected to a virtual ground, Q2/D2 and Q4/D4 take the bipolar antilog of V3, creating an output current which is a precise replica of the input current. If pin 2 ( $E_{c+}$ ) and pin 3 ( $E_{c-}$ ) are held at ground, the output current will equal the input current. For pin 2 positive or pin 3 negative, the output current will be scaled larger than the input current. For pin 2 negative or pin 3 positive, the output current is scaled smaller than the input.

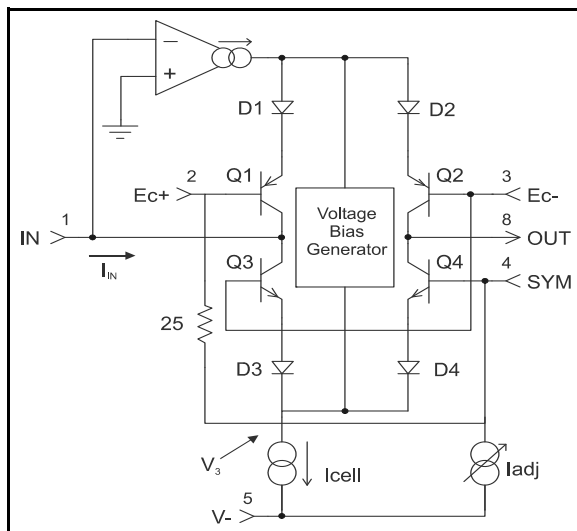

Figure 5. Simplified Internal Circuit Diagram

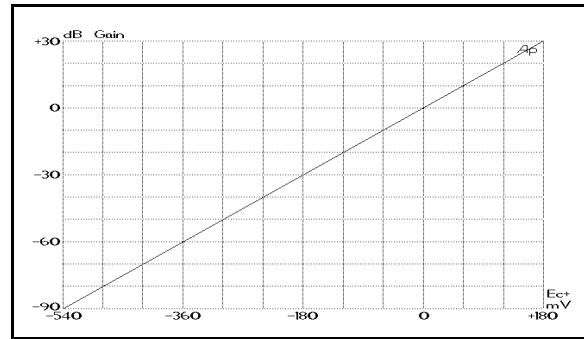

Figure 6. Gain vs. Control Voltage ( $E_{c+}$ , Pin 2) at 25°C

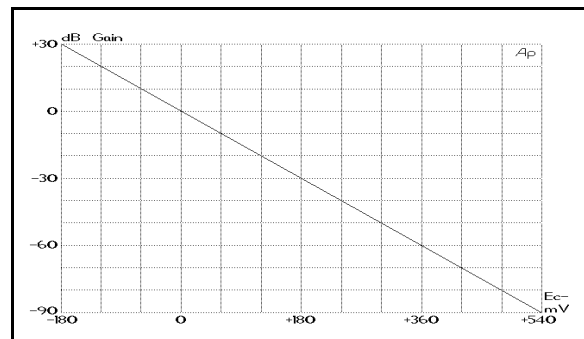

Figure 7. Gain vs. Control Voltage ( $E_{c-}$ , Pin 3) at 25°C

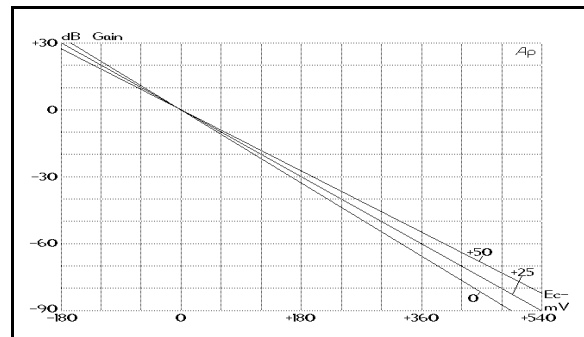

Figure 8. Gain vs. Control Voltage ( $E_{c-}$ ) with Temp (°C)

In normal operation, the output current is converted to a voltage via an opamp-based I-V converter, as shown in Figure 2, where the conversion ratio is determined by the feedback resistor connected between the output and inverting input. The signal path through the VCA and the output opamp is non-inverting.

The scale factor between the output and input currents is the gain of the VCA. Either pin 2 ( $E_{c+}$ ) or pin 3 ( $E_{c-}$ ), or both, may be used to control gain. Gain is exponentially proportional to the voltage at pin 2, and exponentially proportional to the negative of the voltage at pin 3. Therefore, pin 2 ( $E_{c+}$ ) is the *positive* control port, while pin 3 ( $E_{c-}$ ) is the

4. For more details about the internal workings of the 2180 Series of VCAs, see *An Improved Monolithic Voltage-Controlled Amplifier*, by Gary K. Hebert (Chief Technology Officer, for THAT Corporation), presented at the 99th convention of the Audio Engineering Society, New York, Preprint number 4055.

negative control port. Because of the exponential characteristic, the control voltage sets gain *linearly in decibels*. Figure 6 shows the decibel current gain of a 2180 versus the voltage at Ec+, while Figure 7 shows gain versus the Ec-.

## Temperature Effects

The logging and antilogging in the VCA depends on the logarithmic relationship between voltage and current in a semiconductor junction (in particular, between a transistor's  $V_{be}$  and  $I_c$ ). As is well known, this relationship is temperature dependent. Therefore, the gain of any log-antilog VCA depends on its temperature.

Figure 8 shows the effect of temperature on the negative control port. (The positive control port behaves in the same manner.) Note that the gain at  $E_c = 0$  V is 0 dB, regardless of temperature. Changing temperature changes the *scale factor* of the gain by 0.33%/°C, which pivots the curve about the 0 dB point.

Mathematically, the 2180's gain characteristic is

$$Gain = \frac{E_{C+} - E_{C-}}{(0.0061)(1 + 0.0033 \Delta T)} \quad \text{Eq. 1}$$

where  $\Delta T$  is the difference between room temperature (25°C) and the actual temperature, and Gain is the gain in decibels. At room temperature, this reduces to

$$Gain = \frac{E_{C+} - E_{C-}}{0.0061} \quad \text{Eq. 2}$$

If only the positive control port is used, this becomes

$$Gain = \frac{E_{C+}}{0.0061} \quad \text{Eq. 3}$$

If only the negative control port is used, this becomes

$$Gain = \frac{E_{C-}}{0.0061} \quad \text{Eq. 4}$$

## DC Bias Currents

The 2180 current consumption is determined by the resistor between pin 5 (V-) and the negative supply voltage ( $V_{EE}$ ). Typically, with 15V supplies, the resistor is 5.1 k $\Omega$ , which provides approximately 2.4 mA. This current is split into two paths: 570  $\mu$ A is used for biasing the IC, and the remainder becomes  $I_{cell}$  as shown in Figure 5.  $I_{cell}$  is further split in two parts: about 20  $\mu$ A biases the core transistors (Q1 through Q4), the rest is available for input and output signal current.

## DC Feedthrough

Normally, a small dc error term flows in pin 8 (the output). When the gain is changed, the dc term changes. This control-voltage feedthrough is more pronounced with gain; the -A version of the part produces the least feedthrough, the -C version the most. See Figure 9 for typical curves for dc offset vs. gain

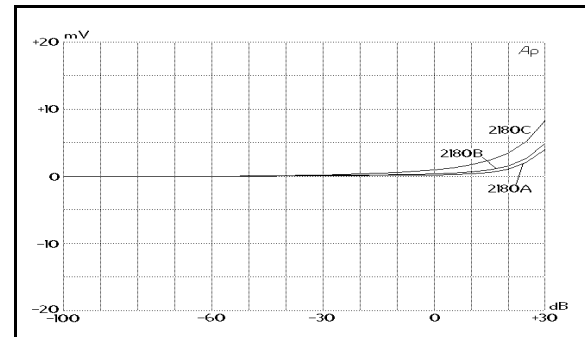

Figure 9. Representative DC Offset vs. Gain

## Audio Performance

The 2180-Series VCA design, fabrication and testing ensure extremely good audio performance when used as recommended. In particular, the 2180 maintains low distortion over a wide range of gain, cut and signal levels. Figures 10 through 12 show typical distortion performance for representative samples of each grade of the part. Figure 13 shows the harmonic content of the distortion in a typical B-grade part.

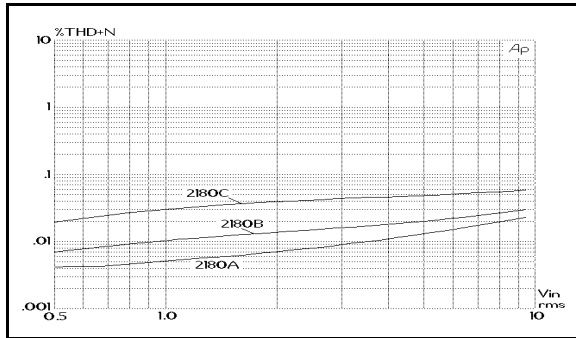

Figure 10. 1 kHz THD+Noise vs. Input Level, 0dB gain

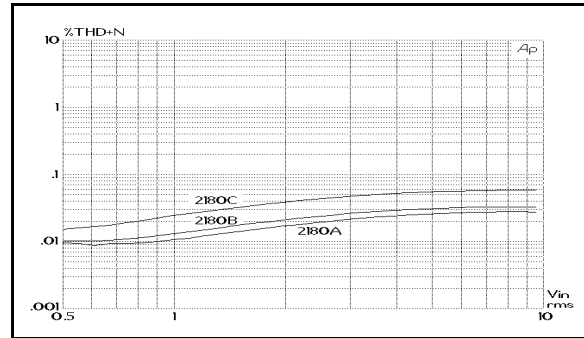

Figure 12. 1 kHz THD+Noise vs. Input Level, -15dB gain

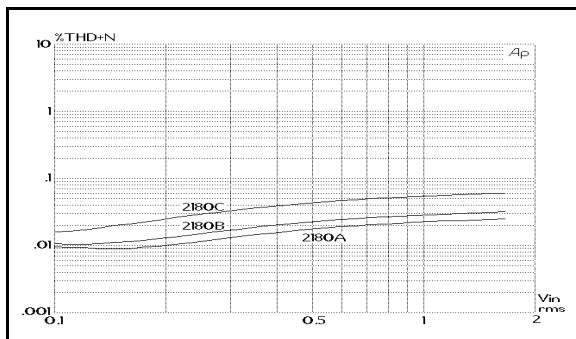

Figure 11. 1 kHz THD+Noise vs. Input Level, +15dB gain

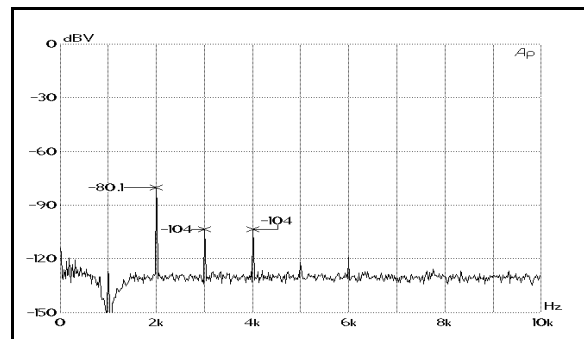

Figure 13. FFT of THD, 0dB gain, 1kHz, 0dBV, Typ. 2180B

## Applications

### Input

As mentioned above, input and output signals are currents, not voltages. While this often causes some conceptual difficulty for designers first exposed to this convention, the current input/output mode provides great flexibility in application.

The Input pin (pin 1) is a virtual ground with negative feedback provided internally (see Figure 5, Page 4). The input resistor (shown as 20 k $\Omega$  in Figure 2, Page 3) should be scaled to convert the available ac input voltage to a current within the linear range of the device. Generally, peak input currents should be kept under 1 mA for best distortion performance.

Figures 10 through 12 show distortion vs. signal level for the three parts in the 2180 Series for 0 dB, +15 dB and -15 dB gain. The circuit of Figure 2, Page 3 was used to generate these curves.

For a specific application, the acceptable distortion will usually determine the maximum signal current level which may be used. Note that, with 20 k $\Omega$  current-to-voltage converting resistors, distortion remains low even at 10 V rms input at 0 dB or -15 dB gain, and at 1.7 V rms input at +15 dB gain (~10 V rms output). This is especially true in the -A and -B grades of the part.

### Distortion vs. Noise

A designer may trade off noise for distortion by decreasing the 20 k $\Omega$  current-to-voltage converting resistors used at the input and output in Figure 2, Page 3. For every dB these resistor values are decreased, the voltage noise at the output of the OP275 is reduced by one dB. For example, with 10 k $\Omega$  resistors, the output noise floor drops to -104 dBV (typical) at 0 dB gain — a 6 dB reduction in noise because 10 k $\Omega$  is 1/2 of (6 dB lower than) 20 k $\Omega$ .

Conversely, if THD is more important than noise performance, increasing these resistors to 40 k $\Omega$  will increase the noise level by 6 dB, while reducing distortion at maximum voltage levels. Furthermore, if maximum signal levels are higher (or lower) than the traditional 10 V rms, these resistors should be scaled to accommodate the actual voltages prevalent in the circuit. Since the 2180 handles signals as currents, these ICs can even operate with signal levels far exceeding the 2180's supply rails, provided appropriately large resistors are used.

### High-Frequency Distortion

The choice of input resistor has an additional, subtle effect on distortion. Since the feedback impedances around the internal opamp (essentially Q1/D1 and Q3/D3) are fixed, low values for the input resistor will require more closed-loop gain from the opamp. Since the open-loop gain naturally falls off at high frequencies, asking for too much gain will lead to increased high-frequency distortion. For best results, this resistor should be kept to 10 k $\Omega$  or above.

### Stability

An additional consideration is stability: the internal op amp is intended for operation with source impedances of less than 60 k $\Omega$  at high frequencies. For most audio applications, this will present no problem

### DC Coupling

The quiescent dc voltage level at the input (the input offset voltage) is approximately +0 mV, but, as in many general-purpose opamps, this is not well controlled. Any dc input currents will cause dc in the output which will be modulated by gain; this may cause audible thumps. If the input is dc coupled, dc input currents may be generated due to the input offset voltage of the 2180 itself, or due to offsets in stages preceding the 2180. Therefore, capacitive coupling is almost mandatory for quality audio applications. Choose a capacitor which will give acceptable low frequency performance for the application.

### Summing Multiple Input Signals

Multiple signals may be summed via multiple resistors, just as with an inverting opamp configuration. In such a case, a single coupling capacitor may be located next to pin 1 rather than multiple capacitors at the driven ends of the summing resistors. However, take care that the capacitor does not pick up stray signals.

### Output

The Output pin (pin 8) is intended to be connected to a virtual ground node, so that current flowing in it may be converted to a voltage (see Figures 2 & 14). Choose the external opamp for good audio performance. The feedback resistor should be chosen based on the desired current-to-voltage conversion constant. Since the input resistor determines the voltage-to-current conversion at the input,

the familiar ratio of  $R_f/R_i$  for an inverting opamp will determine the overall voltage gain when the 2180 is set for 0 dB current gain. Since the VCA performs best at settings near unity gain, use the input and feedback resistors to provide design-center gain or loss, if necessary.

A small feedback capacitor around the output opamp is needed to cancel the output capacitance of the VCA. Without it, this capacitance will destabilize most opamps. The capacitance at pin 8 is typically 15 pF.

## Power Supplies

### Positive

The positive supply is connected directly to  $V_+$  (pin 7). No special bypassing is necessary, but it is good practice to include a small ( $\sim 1 \mu\text{F}$ ) electrolytic or ( $\sim 0.1 \mu\text{F}$ ) ceramic capacitor close to the VCA IC on the PCB. Performance is not particularly dependent on supply voltage. The lowest permissible supply voltage is determined by the sum of the input and output currents plus  $I_{\text{SET}}$ , which must be supplied through the output of the internal transconductance amplifier and down through the core and voltage bias generator. Reducing signal currents may help accommodate low supply voltages. THAT Corporation intends to publish an application note covering operation on low supply voltages. Please inquire for its availability.

The highest permissible supply voltage is fixed by the process characteristics and internal power consumption. +18 V is the nominal limit.

### Negative

The negative supply terminal is  $V_-$  (pin 5). Unlike normal negative supply pins, this point is intended to be connected to a current source  $I_{\text{SET}}$  (usually simply a resistor to  $V_{\text{EE}}$ ), which determines the current available for the device. As mentioned before, this source must supply the sum of the input and output signal currents, plus the bias to run the rest of the IC. The minimum value for this current is  $570 \mu\text{A}$  over the sum of the required signal currents. Usually,  $I_{\text{SET}}$  should equal 2.4 mA for most pro audio applications with  $\pm 15 \text{ V}$  supplies. Higher bias levels are of limited value, largely because the core transistors become ineffective at logging and antilogging at currents over 1 mA.

Mathematically, this can be expressed as

$$I_{\text{CELL}} \geq \text{Peak}(I_{\text{IN}}) + \text{Peak}(I_{\text{OUT}}) + 220 \mu\text{A}; \text{ and}$$

$$I_{\text{CELL}} = I_{\text{SET}} - 350 \mu\text{A}. \text{ Therefore,}$$

$$I_{\text{SET}} \geq \text{Peak}(I_{\text{IN}}) + \text{Peak}(I_{\text{OUT}}) + 570 \mu\text{A}.$$

The voltage at  $V_-$  (pin 5) is four diode drops below ground, which, for the 2180, is approximately -2.85 V. Since this pin connects to a (high impedance) current supply, not a voltage supply, bypassing at pin 5 is not normally necessary.

### Ground

The GND pin (pin 6) is used as a ground reference for the VCA. The non-inverting input of the internal opamp is connected here, as are various portions of the internal bias network. It may not be used as an additional input pin.

## Voltage Control

### Negative Sense

$E_c$  (pin 3) is the negative voltage control port. This point controls gain inversely with applied voltage: positive voltage causes loss, negative voltage causes gain. As described on Page 5, the current gain of the VCA is unity when pin 3 is at 0 V with respect to pin 2, and varies with voltage at approximately -6.1 mV/dB, at room temperature.

### Positive Sense

As mentioned earlier,  $E_{c+}$  (pin 2) is the positive-sense voltage control port. A typical circuit using this approach is shown in Figure 14.  $E_c$  (pin 3) should be grounded, and  $E_{c+}$  (pin 2) driven from a low-impedance voltage source. Using the opposite sense of control can sometimes save an inverter in the control path. In order to maintain the wafer level adjustment which minimizes THD, leave pin 4 **open**.

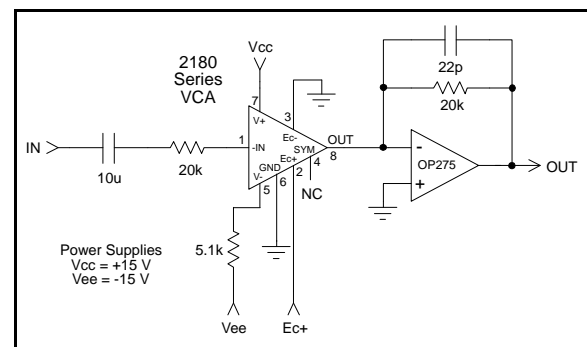

Figure 14. Positive control port using Pin 2 ( $E_{c+}$ )



## Positive and Negative

It is also possible (and sometimes advantageous) to drive both control ports, either with differential drive (in which case, the control sensitivities of each port are summed), or through two different control signals. There is no reason why both control ports cannot be used simultaneously.

## Control Port Drive Impedance

The control ports (pins 2 through 4) are connected directly to the bases of the logging and/or antilogging transistors. The accuracy of the logging and antilogging is dependent on the  $E_{C+}$  and  $E_{C-}$  voltages being exactly as desired to control gain. The base current in the core transistors will follow the collector currents, of course. Since the collector currents are signal-related, the base currents are therefore also signal-related. Should the source impedance of the control voltage(s) be large, the signal-related base currents will cause signal-related voltages to appear at the control ports, which will interfere with precise logging and antilogging, in turn causing distortion.

The 2180 Series VCAs are designed to be operated with zero source impedance at pins 2 and 3, and an infinite source impedance at pin 4. (pin 4 should be left open.) To realize all the performance designed into a 2180, keep the source impedance of the control voltage driver well under 50  $\Omega$ .

This often suggests driving the control port directly with an opamp. However, the closed-loop output impedance of an opamp typically rises at high frequencies because open loop gain falls off as frequency increases. A typical opamp's output impedance is therefore inductive at high frequencies. Excessive inductance in the control port source impedance can cause the VCA to oscillate internally. In such cases, a 100  $\Omega$  resistor in series with a 1.5 nF capacitor from the control port to ground will usually suffice to prevent the instability.

## Noise Considerations

It is second nature among good audio designers to consider the effects of noisy devices on the signal path. As is well known, this includes not only active devices such as opamps and transistors, but extends to the choice of impedance levels as well. High value resistors have higher inherent thermal noise, and the noise performance of an otherwise quiet circuit can be easily spoiled by the wrong choice of impedance levels.

Less well known, however, is the effect of noisy circuitry and high impedance levels in the control path of voltage-control circuitry. The 2180 Series

VCAs act like multipliers: when no signal is present at the signal input, noise at the control input is rejected. So, when measuring noise (in the absence of signal – as most everyone does), even very noisy control circuitry often goes unnoticed. However, noise at the control port of these parts will cause noise modulation of the signal. This can become significant if care is not taken to drive the control ports with quiet signals.

The 2180 Series VCAs have a small amount of inherent noise modulation because of its class AB biasing scheme, where the shot noise in the core transistors reaches a minimum with no signal, and increases with the square root of the instantaneous signal current. However, in an optimum circuit, the noise floor rises only to -94 dBV with a 50  $\mu$ A rms signal at unity gain — 4 dB of noise modulation. By contrast, if a unity-gain connected, non-inverting 5534 opamp is used to directly drive the control port, the noise floor will rise to 92 dBV — 6 dB of noise modulation.

To avoid excessive noise, one must take care to use quiet electronics throughout the control-voltage circuitry. One useful technique is to process control voltages at a multiple of the eventual control constant (e.g., 61 mV/dB — ten times higher than the VCA requires), and then attenuate the control signal just before the final drive amplifier. With careful attention to impedance levels, relatively noisy opamps may be used for all but the final stage.

## Stray Signal Pickup

It is also common practice among audio designers to design circuit boards to minimize the pickup of stray signals within the signal path. As with noise in the control path, signal pickup in the control path can adversely effect the performance of an otherwise good VCA. Because it is a multiplier, the 2180 produces second harmonic distortion if the audio signal itself is present at the control port. Only a small voltage at the control port is required: as little as 10  $\mu$ V of signal can increase distortion to over 0.01%. This can frequently be seen at high frequencies, where capacitive coupling between the signal and control paths can cause stray signal pickup.

Because the signal levels involved are very small, this problem can be difficult to diagnose. One useful technique is to temporarily bypass the control port to ground via a modest-sized capacitor (e.g., 10  $\mu$ F). If the distortion diminishes, signal pickup in the control path is the likely cause.

## Temperature Sensitivity

As shown by the equation for  $A_v$  (Page 5), the gain of a 2180 VCA is sensitive to temperature in

proportion to the amount of gain or loss commanded. The constant of proportionality is 0.33% of the decibel gain commanded, per degree Celsius, referenced to 27°C (300°K). This means that at 0 dB gain, there is no change in gain with temperature. However, at -122 mV, the gain will be +20 dB at room temperature, but will be 20.66 dB at a temperature 10°C lower.

For most audio applications, this change with temperature is of little consequence. However, if necessary, it may be compensated by a resistor embedded in the control voltage path whose value

varies with temperature at the same rate of 0.33%/°C. Such parts are available from RCD Components, Inc, [www.rcd-comp.com](http://www.rcd-comp.com), and KOA/Speer Electronics, [www.koaspeer.com](http://www.koaspeer.com)

### Closing Thoughts

THAT Corporation welcomes comments, questions and suggestions regarding these devices, their design and application. Our engineering staff includes designers who have decades of experience in applying our parts. Please feel free to contact us to discuss your applications in detail.

## Package Information

The THAT 2180-series is available in a 8-pin SIP package. Package dimensions are shown in Figure 15 below; Pinouts are given in Table 1 on page 1. Ordering information is provided in Table 2 also on page 1.

The 2180-series package is entirely lead-free. The lead-frame is copper, plated with successive layers of nickel, palladium, and gold. This approach

makes it possible to solder these devices using lead-free and lead-bearing solders.

Neither the lead-frame nor the plastic mold compound used in the 2180-series contains any hazardous substances as specified in the European Union's *Directive on the Restriction of the Use of Certain Hazardous Substances in Electrical and Electronic Equipment 2002/95/EG* of January 27, 2003.

<b><u>Package Characteristics</u></b>						
Parameter	Symbol	Conditions	Min	Typ	Max	Units
Package Style		See Fig. 15 for dimensions		8 Pin SIP		
Thermal Resistance	$\theta_{JA}$	SIP package soldered to board		100		°C/W
Environmental Regulation Compliance						Complies with January 27, 2003 RoHS requirements

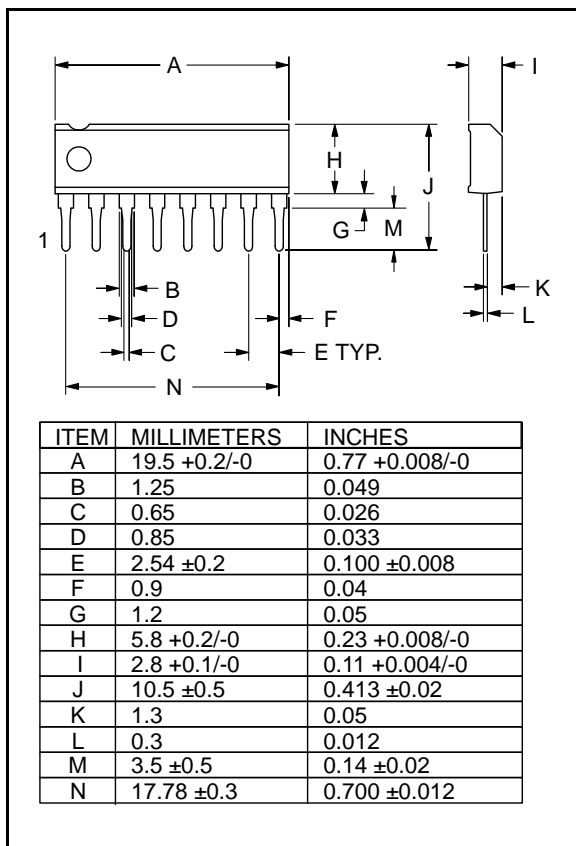

Figure 15. -L (SIP) version package outline drawing

## **Notes**



Компания «ЭлектроПласт» предлагает заключение долгосрочных отношений при поставках импортных электронных компонентов на взаимовыгодных условиях!

Наши преимущества:

- Оперативные поставки широкого спектра электронных компонентов отечественного и импортного производства напрямую от производителей и с крупнейших мировых складов;
- Поставка более 17-ти миллионов наименований электронных компонентов;
- Поставка сложных, дефицитных, либо снятых с производства позиций;
- Оперативные сроки поставки под заказ (от 5 рабочих дней);
- Экспресс доставка в любую точку России;
- Техническая поддержка проекта, помощь в подборе аналогов, поставка прототипов;
- Система менеджмента качества сертифицирована по Международному стандарту ISO 9001;
- Лицензия ФСБ на осуществление работ с использованием сведений, составляющих государственную тайну;
- Поставка специализированных компонентов (Xilinx, Altera, Analog Devices, Intersil, Interpoint, Microsemi, Aeroflex, Peregrine, Syfer, Eurofarad, Texas Instrument, Miteq, Cobham, E2V, MA-COM, Hittite, Mini-Circuits, General Dynamics и др.);

Помимо этого, одним из направлений компании «ЭлектроПласт» является направление «Источники питания». Мы предлагаем Вам помощь Конструкторского отдела:

- Подбор оптимального решения, техническое обоснование при выборе компонента;
- Подбор аналогов;
- Консультации по применению компонента;
- Поставка образцов и прототипов;
- Техническая поддержка проекта;
- Защита от снятия компонента с производства.



#### Как с нами связаться

**Телефон:** 8 (812) 309 58 32 (многоканальный)

**Факс:** 8 (812) 320-02-42

**Электронная почта:** [org@eplast1.ru](mailto:org@eplast1.ru)

**Адрес:** 198099, г. Санкт-Петербург, ул. Калинина, дом 2, корпус 4, литера А.